

AEC-Q200 *Automotive Grade* *Capacitors*

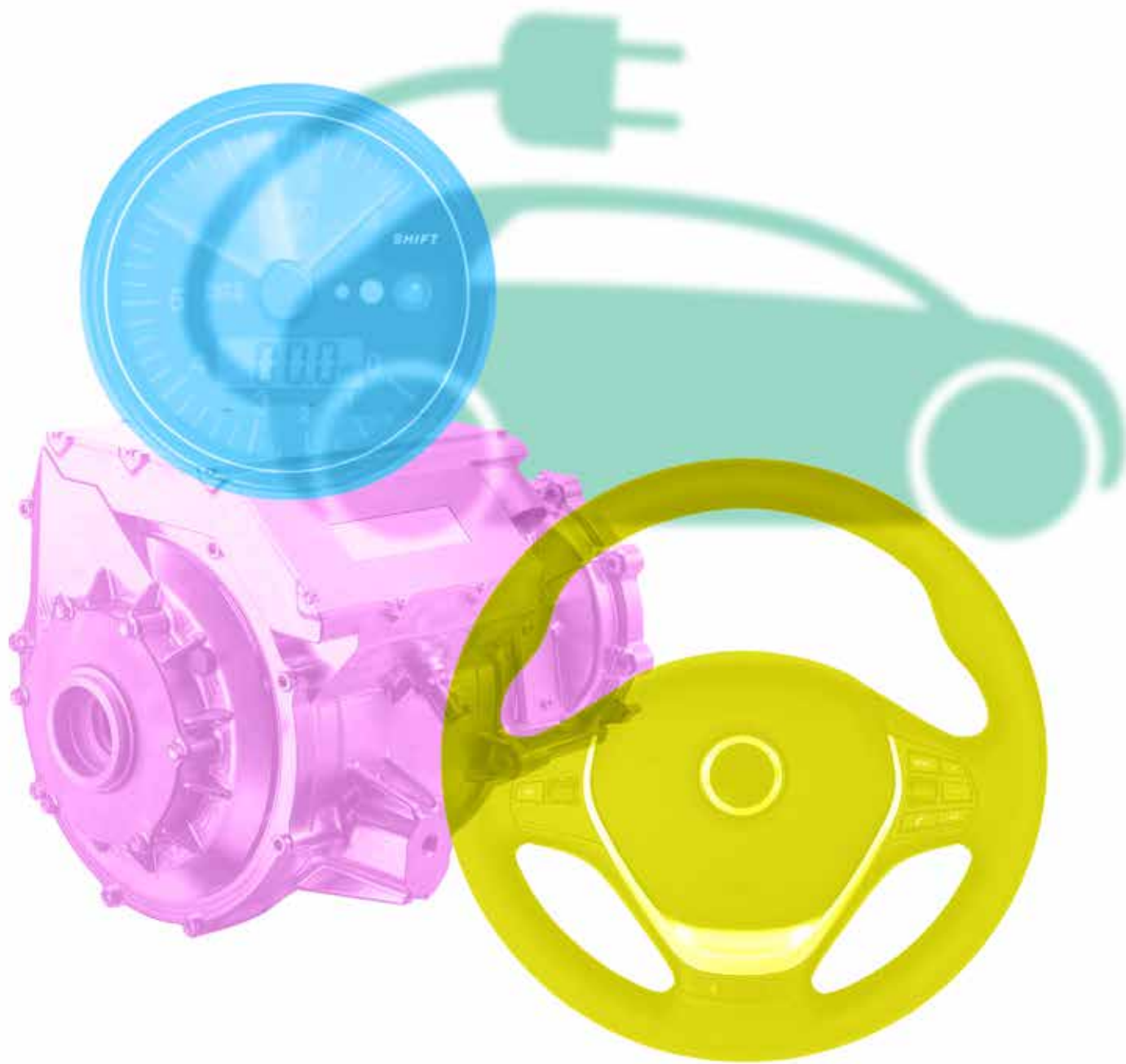

COMPEX • DLI • JOHANSON MFG
NOVACAP • SYFER • VOLTRONICS

AEC-Q200 Automotive Grade Capacitors

At Knowles Precision Devices (KPD) we manufacture Single Layer, Multilayer, High Reliability and Precision Variable Capacitors; EMI Filters and Thin Film Devices.

One of our fields of expertise is the design and manufacture of components important to engineers in the automotive industry. Today's vehicles have many electronic control units that enable absolute precision and control.

The Automotive Electronics Council (AEC) Component Technical Committee is the standardization body for establishing standards for reliable, high quality electronic components. Components meeting these specifications are suitable for use in the harsh automotive environment without additional component-level qualification testing.

The Component Technical Committee established AEC-Q200 "Stress Test Qualification for Passive Components" to define the minimum stress test driven qualification requirements for passive

electrical devices including ceramic capacitors.

KPD's Syfer brand has developed a range of MLC capacitors and surface mount EMI filters qualified to AEC-Q200 rev D to meet the needs of high reliability and automotive manufacturers.

Knowles Suzhou (China), Norwich (England) & Penang (Malaysia) facilities are accredited to IATF 16949:2016 for the design, manufacture and supply of AEC-Q200 qualified MLCC components.

Please refer to the following pages for details of the product ranges offered.

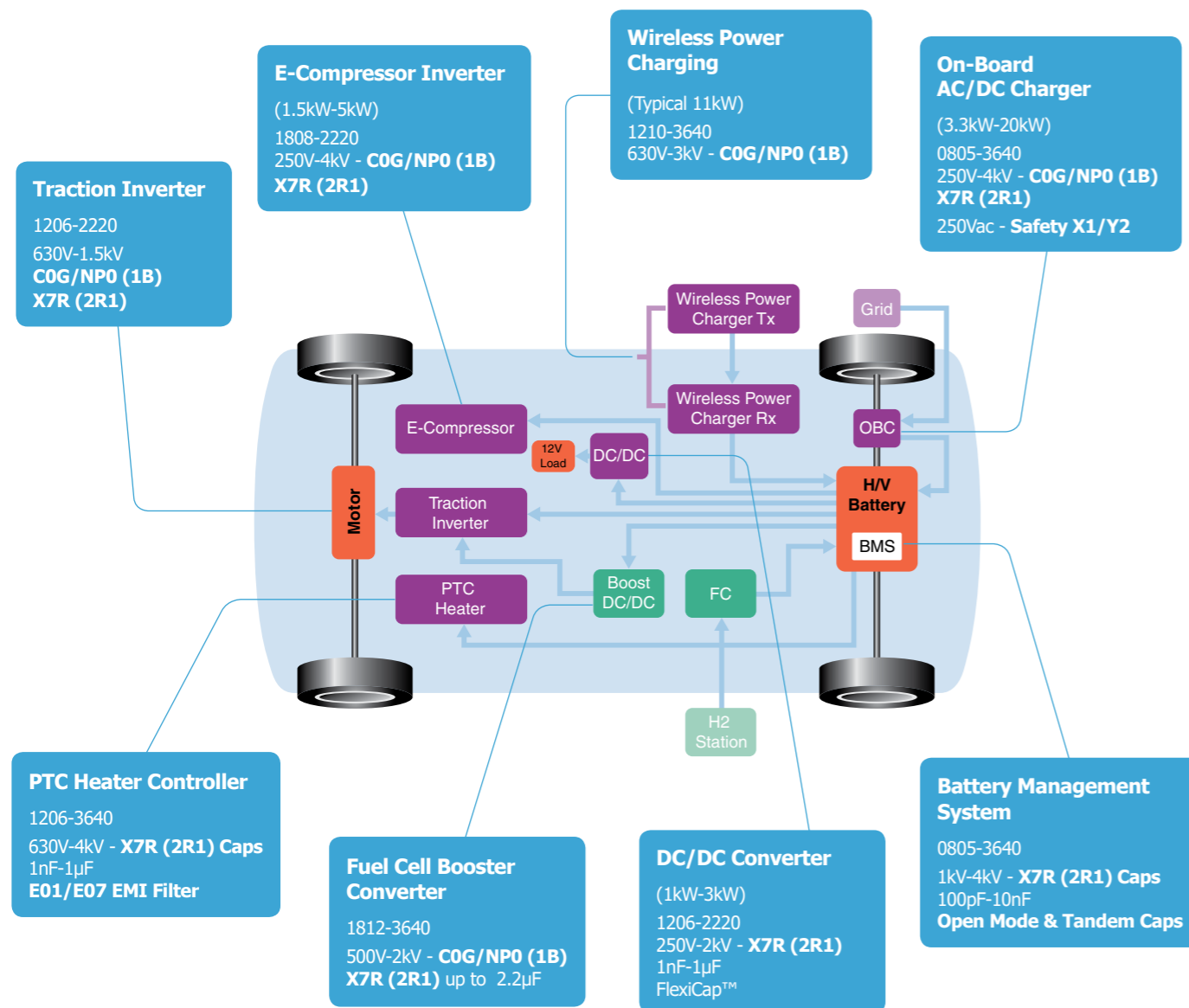

Electric / New Energy Vehicle - BEV/HEV/PHEV/FCV

Contents

General & Technical Introduction	Dielectric classifications and characteristics	4-6
	FlexiCap™	7
	IECQ-CECC and AEC-Q200 Periodic Tests	8
	Manufacturing processes	9
	Testing	10
	Regulations and Compliance	11
	Explanation on Ageing of MLC.....	12
	Handling, Storage, Soldering and Mechanical Precautions.....	13-14
	Packaging Information - Ceramic chip capacitors	15-16
	Chip Dimensions	17
MLC Capacitors	Automotive Grade - AEC-Q200 ranges - COG/NP0 (1B)	18-19
	Automotive Grade - AEC-Q200 ranges - X7R (2R1)	20-21
	Chip Ordering Information	22
	StackiCap™ - X7R (2R1)	23
	Safety Certified Capacitors	24-26
	Open Mode - COG/NP0 (1B) & X7R (2R1)	27
	Tandem - X7R (2R1)	28
	High Temperature - X8R - 150°C	29
	Ultra-low ESR HiQ MLCCs - X8G range	30-31
	SM EMI Filters	Surface Mount EMI Filters - E01 & E07.....
X2Y Integrated Passive Components - E03.....		34-35

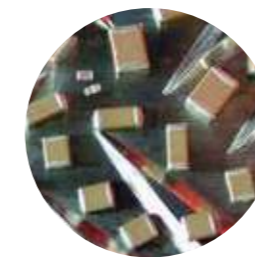

AEC-Q200 approved ranges - pages 18-21



StackiCap™ Capacitors - page 23

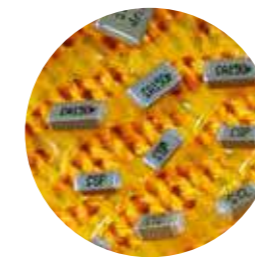

Safety Certified Capacitors - pages 24-26

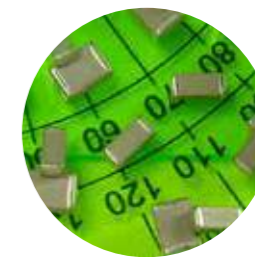

Open Mode & Tandem Capacitors - pages 27-28

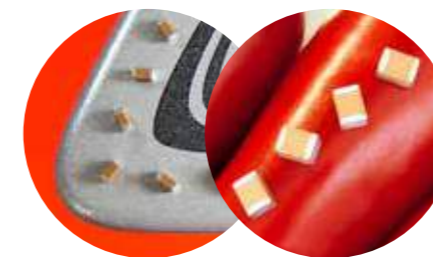

High Temperature Capacitors - pages 29-31

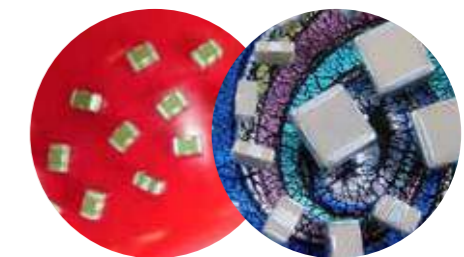

Surface Mount EMI Filters - pages 32-35

Dielectric characteristics

Class I Dielectrics

Multilayer Ceramic Capacitors are generally divided into classes which are defined by the capacitance temperature characteristics over specified temperature ranges. These are designated by alpha numeric codes. Code definitions are summarised below and are also available in the relevant national and international specifications.

Capacitors within this class have a dielectric constant range from 10 to 100. They are used in applications which require ultra stable

dielectric characteristics with negligible dependence of capacitance and dissipation factor with time, voltage and frequency. They exhibit the following characteristics:-

- a) Time does not significantly affect capacitance and dissipation factor (Tan δ) – no ageing.
- b) Capacitance and dissipation factor are not affected by voltage.
- c) Linear temperature coefficient.

		Class I Dielectrics						
		COG/ NPO (1B) (Porcelain)	P90 (Porcelain)	COG/NPO (1B)		X8G	Class I High Temperature	
		Ultra stable	Ultra stable	Ultra stable		Ultra stable	Ultra stable	
Dielectric classifications	IECQ-CECC	-	-	1B/CG		-	-	-
	EIA	COG/NPO (1B)	P90	COG/NPO (1B)		X8G	-	-
	MIL	-	-	CG (BP)		-	-	-
Ordering code	DLI	CF	AH	-	-	-	-	-
	Novacap	-	-	-	N, RN	-	F	D, RD
	Syfer	-	-	Q, U	C	H	-	G
	Voltronics	F	H	Q	-	-	-	-
Rated temperature range		-55°C to +125°C	-55°C to +125°C	-55°C to +125°C	-55°C to +125°C	-55°C to +150°C	-55°C to +160°C	-55°C to +200°C
Maximum capacitance change over temperature range	No DC voltage applied	0 ±15 ppm/°C	0 ±20 ppm/°C	0 ±30 ppm/°C	0 ±30 ppm/°C	0 ±30 ppm/°C	0 ±30 ppm/°C	0 ±30 ppm/°C
	Rated DC voltage applied	-						
Tangent of loss angle (tan δ)		≤0.0005 @1MHz		≤0.0005 @1MHz	>50pF ≤0.0015 ≤50pF 0.0015 (15 + 0.7) Cr	≤0.0005 @1MHz	≤0.001	
Insulation resistance (Ri)	Time constant (Ri x Cr)	@25°C = 10 ⁶ MΩ min @125°C = 10 ⁵ MΩ min		100GΩ or 1000s (whichever is the least)		@25°C = 100GΩ or 1000ΩF @160°C & 200°C = 1GΩ or 10ΩF (whichever is the least)		Time constant (Ri x Cr)
Capacitance Tolerance	Cr <4.7pF	±0.05pF, ±0.10pF, ±0.25pF, ±0.5pF						
	Cr ≥4.7 to <10pF	±0.10pF, ±0.25pF, ±0.5pF						
	Cr ≥10pF	±1%, ±2%, ±5%, ±10%						
Dielectric strength Voltage applied for 5 seconds. Charging current limited to 50mA maximum.	≤200V	2.5 times		2.5 times				
	>200V to <500V			Rated voltage +250V				
	500V to ≤1kV			1.5 times				
	>1kV to ≤1.2kV			1.25 times				
	>1.2kV			N/A		1.2 times		
Climatic category (IEC)	Chip	-	-	55/125/56		-	-	
	Dipped	-	-	-	55/125/21	-	-	
	Discoidal	-	-	-	55/125/56	-	-	
Ageing characteristic (Typical)		Zero						
Approvals	Syfer Chip	-	-	-	QC-32100	-	-	

Dielectric characteristics

Class II Dielectrics

Capacitors of this type have a dielectric constant range of 1000-4000 and also have a non-linear temperature characteristic which exhibits a dielectric constant variation of less than ±15% (2R1) from its room temperature value, over the specified temperature range. Generally used for by-passing (decoupling), coupling, filtering, frequency discrimination, DC blocking and voltage transient suppression with greater volumetric efficiency than Class I units, whilst maintaining stability within defined limits.

Capacitance and dissipation factor are affected by:-

- a) Time (Ageing)
- b) Voltage (AC or DC)
- c) Frequency

		Class II Dielectrics						
		X5R	X7R (2R1)			X8R	Class II High Temperature	
		Stable	Stable			Stable	Stable	
Dielectric classifications	-	2C1	2R1	2X1	-	-	-	IECQ-CECC
	X5R	-	X7R (2R1)		-	X8R	-	EIA
	-	BZ	-	BX	-	-	-	MIL
	-	-	-	-	-	-	-	DLI
Ordering code	BW	-	B, RB	X	S	G	E, RE	Novacap
	P	R	X	B	N	-	X	Syfer
	-	-	X	-	-	-	-	Voltronics
	-55°C to +85°C	-55°C to +125°C	-55°C to +125°C	-55°C to +150°C	-55°C to +160°C	-55°C to +200°C	-	Rated temperature range
Maximum capacitance change over temperature range	±15%	±15%	±15%	±15%	±15%	+15 -40%	+15 -65%	No DC voltage applied
	-	+15 -45%	-	+15 -25%	-	-	-	Rated DC voltage applied
Tangent of loss angle (tan δ)	≤ 0.025 Typical*	>25V ≤0.025 ≤25V ≤0.035			≤0.025	≤0.025		Tangent of loss angle (tan δ)
Insulation resistance (Ri)	100GΩ or 1000s (whichever is the least)							Time constant (Ri x Cr)
Capacitance Tolerance	±5%, ±10%, ±20%							
	2.5 times							≤200V
	Rated voltage +250V							>200V to <500V
Dielectric strength Voltage applied for 5 seconds. Charging current limited to 50mA maximum.	1.5 times							500V to <1kV
	1.2 times							≥1kV
	55/85/56	55/125/56			55/150/56	-	Chip	
Climatic category (IEC)	-	55/125/21			-	-	Dipped	
	-	55/125/56			-	-	Discoidal	
	5% Typical	<2% per time decade						
Approvals	-	QC-32100	-	-	-	QC-32100	-	Syfer Chip

* Refer to the MLC Capacitors catalogue for details of Dissipation Factor.

Dielectric characteristics

Typical dielectric temperature characteristics

Porcelain COG/NP0 (1B) & P90

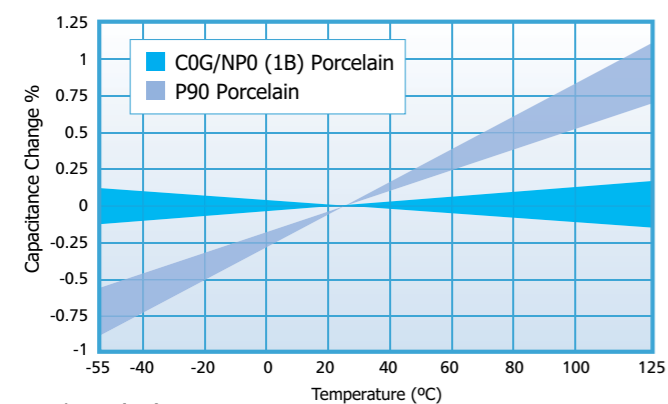

COG/NP0 (1B)

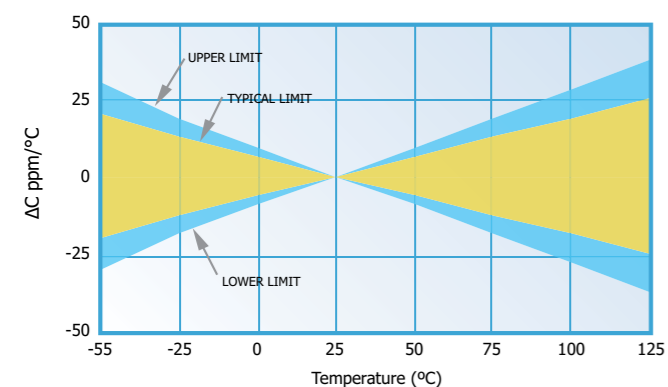

X7R (2R1)

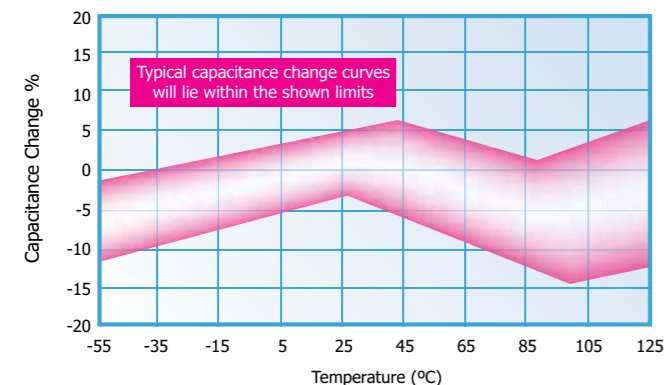

Impedance vs Frequency

Ultra Stable COG/NP0 (1B) dielectric

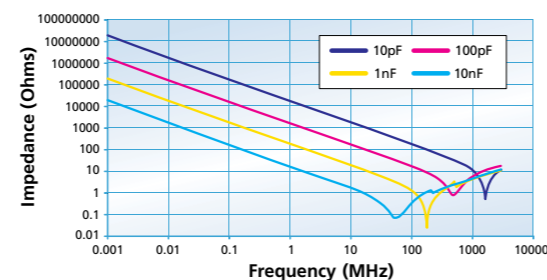

Stable X7R (2R1) dielectric

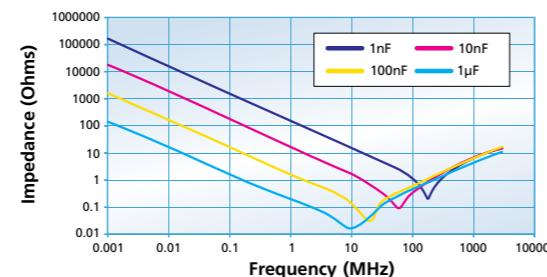

Stable X7R (2R1) dielectric - 10nF

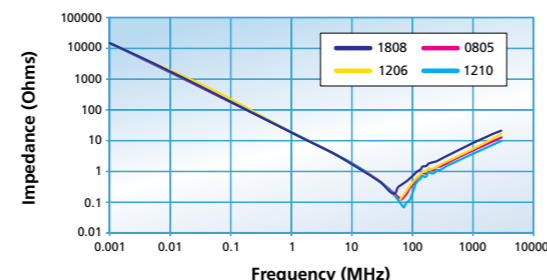

ESR vs Frequency - chips

Ultra Stable COG/NP0 (1B) dielectric

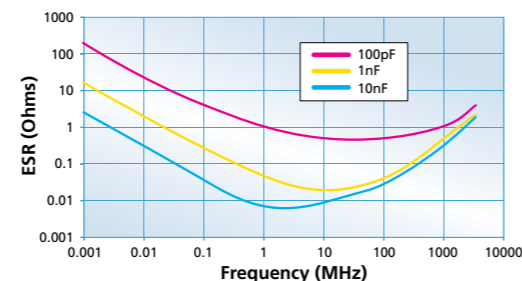

Stable X7R (2R1) dielectric

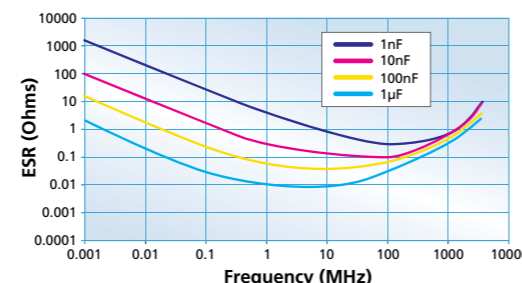

FlexiCap™ overview

FlexiCap™ termination

MLCCs are widely used in electronic circuit design for a multitude of applications. Their small package size, technical performance and suitability for automated assembly makes them the component of choice for the specifier.

However, despite the technical benefits, ceramic components are brittle and need careful handling on the production floor. In some circumstances they may be prone to mechanical stress damage if not used in an appropriate manner. Board flexing, depanelisation, mounting through hole components, poor storage and automatic testing may all result in cracking.

Careful process control is important at all stages of circuit board assembly and transportation - from component placement to test and packaging. Any significant board flexing may result in stress fractures in ceramic devices that may not always be evident during the board assembly process. Sometimes it may be the end customer who finds out - when equipment fails!

Knowles has the solution - FlexiCap™

FlexiCap™ has been developed as a result of listening to customers' experiences of stress damage to MLCCs from many manufacturers, often caused by variations in production processes.

Our answer is a proprietary flexible epoxy polymer termination material, that is applied to the device under the usual nickel barrier finish. FlexiCap™ will accommodate a greater degree of board bending than conventional capacitors.

Knowles FlexiCap™ termination

Ranges are available with FlexiCap™ termination material offering increased reliability and superior mechanical performance (board flex and temperature cycling) when compared with standard termination materials. Refer to Knowles application note reference AN0001. FlexiCap™ capacitors enable the board to be bent almost twice as much before mechanical cracking occurs. Refer to application note AN0002.

FlexiCap™ is also suitable for Space applications having passed thermal vacuum outgassing tests. Refer to Syfer application note reference AN0026.

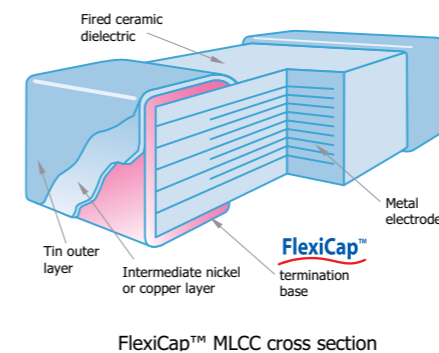

FlexiCap™ benefits

With traditional termination materials and assembly, the chain of materials from bare PCB to soldered termination, provides no flexibility. In circumstances where excessive stress is applied - the weakest link fails. This means the ceramic itself, which may fail short circuit.

The benefit to the user is to facilitate a wider process window - giving a greater safety margin and substantially reducing the typical root causes of mechanical stress cracking.

FlexiCap™ may be soldered using your traditional wave or reflow solder techniques including lead free and needs no adjustment to equipment or current processes.

Knowles has delivered millions of FlexiCap™ components and during that time has collected substantial test and reliability data,

working in partnership with customers world wide, to eliminate mechanical cracking.

An additional benefit of FlexiCap™ is that MLCCs can withstand temperature cycling -55°C to 125°C in excess of 1,000 times without cracking.

FlexiCap™ termination has no adverse effect on any electrical parameters, nor affects the operation of the MLCC in any way.

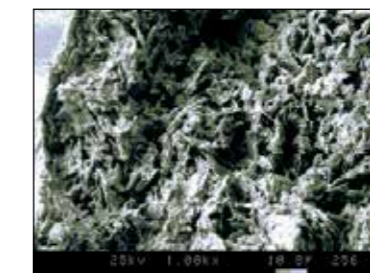

Picture taken at 1,000x magnification using a SEM to demonstrate the fibrous nature of the FlexiCap™ termination that absorbs increased levels of mechanical stress.

Available on the following ranges:

- All High Reliability ranges
- Standard and High Voltage Capacitors
- Open Mode and Tandem Capacitors
- Safety Certified Capacitors
- Non-magnetic Capacitors
- 3 terminal EMI chips
- X2Y Integrated Passive Components
- X8R High Temperature capacitors

Summary of PCB bend test results

The bend tests conducted on X7R (2R1) have proven that the FlexiCap™ termination withstands a greater level of mechanical stress before mechanical cracking occurs.

The AEC-Q200 test for X7R (2R1) requires a bend level of 2mm minimum and a cap change of less than 10%.

Product X7R (2R1)	Typical bend performance under AEC-Q200 test conditions
Standard termination	2mm to 3mm
FlexiCap™	Typically 8mm to 10mm

Application notes

FlexiCap™ may be handled, stored and transported in the same manner as standard terminated capacitors. The requirements for mounting and soldering FlexiCap™ are the same as for standard SMD capacitors.

For customers currently using standard terminated capacitors there should be no requirement to change the assembly process when converting to FlexiCap™.

Based upon board bend tests in accordance with IEC 60384-1 the amount of board bending required to mechanically crack a FlexiCap™ terminated capacitor is significantly increased compared with standard terminated capacitors.

It must be stressed however, that capacitor users must not assume that the use of FlexiCap™ terminated capacitors will totally eliminate mechanical cracking. Good process controls are still required for this objective to be achieved.



Periodic tests conducted for IECQ-CECC and AEC-Q200

Test ref	Test	Termination type	Additional requirements	Sample acceptance			Reference
				P	N	C	
P1	High temperature exposure (storage)	All types	Un-powered. 1,000 hours @ T=150°C. Measurement at 24 ± 2 hours after test conclusion	12	77	0	MIL-STD-202 Method 108
P2	Temperature cycling	COG/NP0 (1B): All types X7R (2R1): Y and H only	1,000 cycles -55°C to +125°C. Measurement at 24 ± 2 hours after test conclusion	12	77	0	JESD22 Method JA-104
P3	Moisture resistance	All types	T = 24 hours/cycle. Note: Steps 7a and 7b not required. Un-powered. Measurement at 24 ± 2 hours after test conclusion	12	77	0	MIL-STD-202 Method 106
P4	Biased humidity	All types	1,000 hours 85°C/85%RH. Rated voltage or 50V whichever is the least and 1.5V. Measurement at 24 ± 2 hours after test conclusion	12	77	0	MIL-STD-202 Method 103
P5	Operational life	All types	Condition D steady state TA=125°C at full rated. Measurement at 24 ± 2 hours after test conclusion	12	77	0	MIL-STD-202 Method 108
P6	Resistance to solvents	All types	Note: Add aqueous wash chemical. Do not use banned solvents	12	5	0	MIL-STD-202 Method 215
P7	Mechanical shock	COG/NP0 (1B): All types X7R (2R1): Y and H only	Figure 1 of Method 213. Condition F	12	30	0	MIL-STD-202 Method 213
P8	Vibration	COG/NP0 (1B): All types X7R (2R1): Y and H only	5g's for 20 minutes, 12 cycles each of 3 orientations. Note: Use 8" x 5" PCB 0.031" thick 7 secure points on one long side and 2 secure points at corners of opposite sides. Parts mounted within 2" from any secure point. Test from 10-2,000Hz	12	30	0	MIL-STD-202 Method 204
P9	Resistance to soldering heat	All types	Condition B, no pre-heat of samples: Single wave solder - Procedure 2	3	12	0	MIL-STD-202 Method 210
P10	Thermal shock	COG/NP0 (1B): All types X7R (2R1): Y and H only	-55°C/+125°C. Number of cycles 300. Maximum transfer time - 20 seconds, dwell time - 15 minutes. Air-Air	12	30	0	MIL-STD-202 Method 107
P11	Adhesion, rapid temp change and climatic sequence	X7R (2R1): A, F and J only	5N force applied for 10s, -55°C/ +125°C for 5 cycles, damp heat cycles	12	27	0	BS EN132100 Clause 4.8, 4.12 and 4.13
P12	Board flex	COG/NP0 (1B): All types X7R (2R1): Y and H only	3mm deflection Class I 2mm deflection Class II	12	30	0	AEC-Q200-005
P13	Board flex	X7R (2R1): A, F and J only	1mm deflection.	12	12	0	BS EN132100 Clause 4.9
P14	Terminal strength	All types	Force of 1.8kg for 60 seconds	12	30	0	AEC-Q200-006
P15	Beam load test	All types	-	12	30	0	AEC-Q200-003
P16	Damp heat steady state	All types	56 days, 40°C / 93% RH 15x no volts, 15x 5Vdc, 15x rated voltage or 50V whichever is the least.	12	45	0	BS EN132100 Clause 4.14

Test results are available on request.
 P = Period in months.
 N = Sample size.
 C = Acceptance criteria.

Production process flowchart

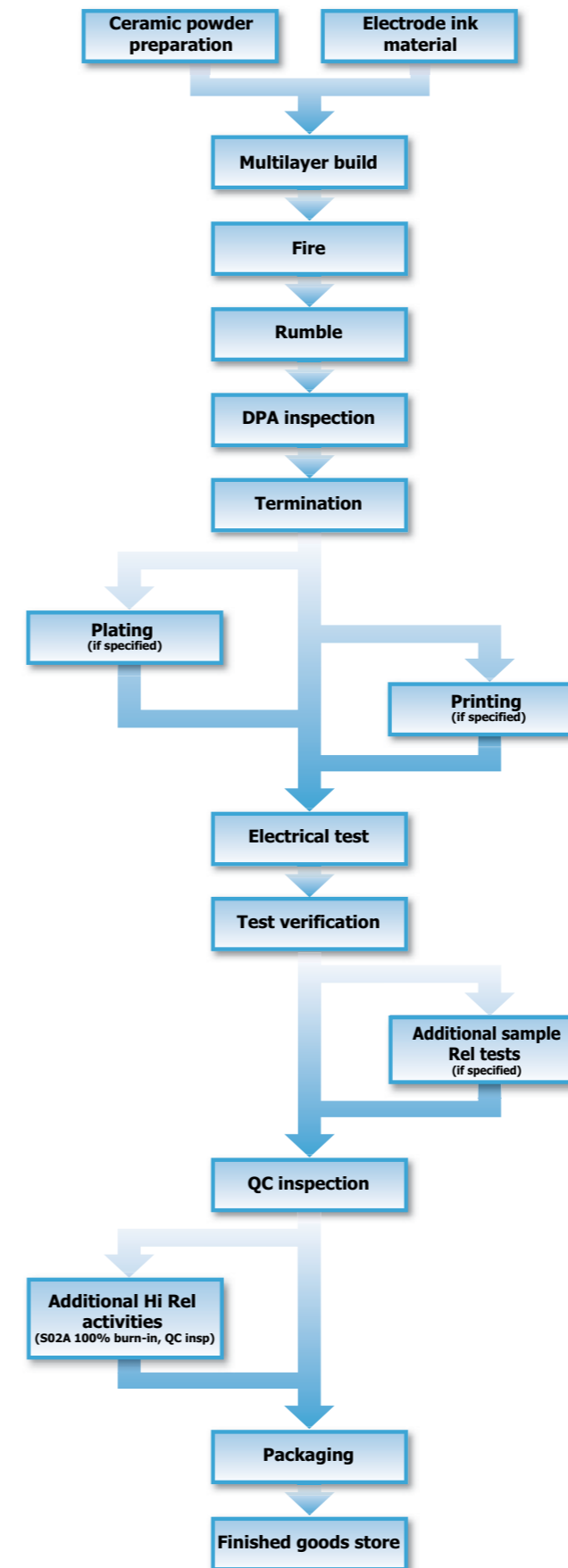

Knowles reliability grades

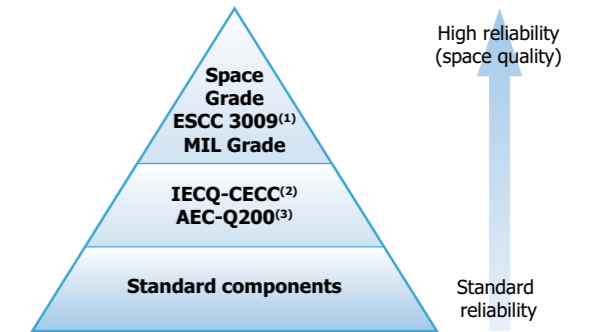

Notes:

- 1) Space grade tested in accordance with ESCC3009 (refer to Knowles Spec S02A 0100) or MIL Grade (in accordance with MIL-PRF-123, MIL-PRF-55681).
- 2) IECQ-CECC. The International Electrotechnical Commission (IEC) Quality Assessment System for Electronic Components. This is an internationally recognised product quality certification which provides customers with assurance that the product supplied meets high quality standards. View Knowles IECQ-CECC approvals at <http://www.iecq.org> or at www.knowlesc capacitors.com
- 3) AEC-Q200. Automotive Electronics Council Stress Test Qualification For Passive Components. Refer to Knowles application note reference AN0009.

Knowles reliability surface mount product groups

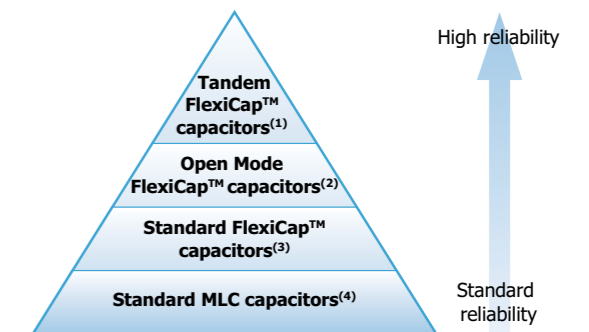

Notes:

- 1) "Tandem" construction capacitors, ie internally having the equivalent of 2 series capacitors. If one of these should fail short-circuit, there is still capacitance end to end and the chip will still function as a capacitor, although capacitance may be affected. Refer to application note AN0021. Also available qualified to AEC-Q200.
- 2) "Open Mode" capacitors with FlexiCap™ termination also reduce the possibility of a short circuit by utilising inset electrode margins. Refer to application note AN0022. Also available qualified to AEC-Q200.
- 3) Multilayer capacitors with Knowles FlexiCap™ termination. By using FlexiCap™ termination, there is a reduced possibility of the mechanical cracking occurring.
- 4) "Standard" capacitors includes MLCCs with tin finish over nickel but no FlexiCap™.

Testing

Tests conducted during batch manufacture

	Knowles reliability SM product group			
	Standard SM capacitors	IECQ-CECC / MIL grade	AEC-Q200	S (Space grade) High Rel S02A ESCC 3009 MIL-PRF-123
Solderability	●	●	●	●
Resistance to soldering heat	●	●	●	●
Plating thickness verification (if plated)	●	●	●	●
DPA (Destructive Physical Analysis)	●	●	●	●
Voltage proof test (DWV / Flash)	●	●	●	●
Insulation resistance	●	●	●	●
Capacitance test	●	●	●	●
Dissipation factor test	●	●	●	●
100% visual inspection	○	○	●	●
100% burn-in. (2xRV @125°C for 168 hours)	○	○	○	●
Load sample test @ 125°C	○	○	●	LAT1 & LAT2 (1000 hours)
Humidity sample test. 85°C/85%RH	○	○	●	240 hours
Hot IR sample test	○	○	○	○
Axial pull sample test (MIL-STD-123)	○	○	○	○
Breakdown voltage sample test	○	○	○	○
Deflection (bend) sample test	○	○	○	○
SAM (Scanning Acoustic Microscopy)	○	○	○	○
LAT1 (4 x adhesion, 8 x rapid temp change + LAT2 and LAT3)	-	-	-	○
LAT2 (20 x 1000 hour life test + LAT3)	-	-	-	○
LAT3 (6 x TC and 4 x solderability)	-	-	-	○

- Test conducted as standard.
- Optional test. Please discuss with the Sales Office.

Regulations and Compliance

Release documentation

	Knowles Precision Devices reliability SM product group			
	Standard SM capacitors	IECQ-CECC	AEC-Q200 MIL grade	S (Space grade) High Rel S02A
Certificate of conformance	●	-	●	●
IECQ-CECC Release certificate of conformity	-	●	-	-
Batch electrical test report	○	○	○	Included in data pack
S (space grade) data documentation package	-	-	-	●

- Release documentation supplied as standard.
- Original documentation.

Periodic tests conducted and reliability data availability

Standard Surface Mount capacitors

Components are randomly selected on a sample basis and the following routine tests are conducted:

- Load Test. 1,000 hours @125°C (150°C for X8R). Applied voltage depends on components tested.
- Humidity Test. 168 hours @ 85°C/85%RH.
- Board Deflection (bend test).

Test results are available on request.

Conversion factors

From	To	Operation
FITS	MTBF (hours)	$10^9 \div \text{FITS}$
FITS	MTBF (years)	$10^9 \div (\text{FITS} \times 8760)$

FITS = Failures in 10^9 hours.
MTBF = Mean time between failures.

REACH (Registration, Evaluation, Authorisation and restriction of Chemicals) statement

The main purpose of REACH is to improve the protection of human health and the environment from the risks arising from the use of chemicals.

Knowles maintains both ISO14001, Environmental Management System and OHSAS 18001 Health and Safety Management System approvals that require and ensure compliance with corresponding legislation such as REACH.

For further information, please contact the Knowles Precision Devices Sales Office at www.knowlescapacitors.com

RoHS compliance

Knowles routinely monitors world wide material restrictions (e.g. EU/China and Korea RoHS mandates) and is actively involved in shaping future legislation.

All standard COG/NP0 (1B), X7R (2R1), X5R, X8R, X8G and High Q Knowles MLCC products are 100% lead free and compliant with the

Export controls and dual-use regulations

Certain Knowles catalogue components are defined as 'dual-use' items under international export controls - those that can be used for civil or military purposes which meet certain specified technical standards.

The defining criteria for a dual use component with respect to Knowles capacitor products is one with a voltage rating of >750Vdc

Example of FIT (Failure In Time) data available:

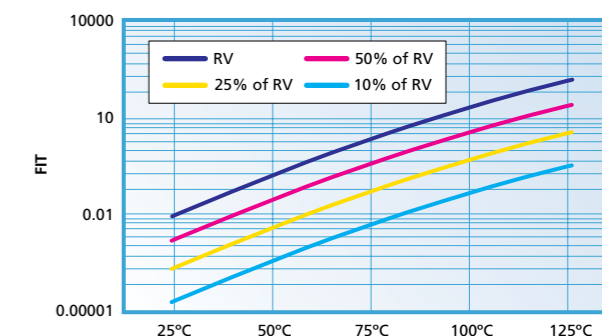

Component type: 0805 (COG/NP0 (1B) and X7R (2R1)).
Testing location: Knowles PD reliability test department.
Results based on: 16,622,000 component test hours.

EU RoHS directive. Those with plated terminations are suitable for soldering using common lead free solder alloys (refer to 'Soldering Information' for more details on soldering limitations). Compliance with the EU RoHS directive automatically signifies compliance with some other legislation (e.g. China and Korea RoHS). Please refer to the Knowles Precision Devices Sales Office for details of compliance with other materials legislation.

Breakdown of material content, SGS analysis reports and tin whisker test results are available on request.

Most Knowles PD MLCC components are available with non RoHS compliant tin lead (SnPb) solderable termination finish for exempt applications and where pure tin is not acceptable. Other tin free termination finishes may also be available – please refer to the Knowles Precision Devices Sales Office for further details.

Environmental certificates can be downloaded from the Knowles Precision Devices website.



and a capacitance value of >250nF when measured at 750Vdc and a series inductance <10nH. Components defined as dual-use under the above criteria may require a licence for export across international borders. Please contact the Sales Office for further information on specific part numbers.

Explanation of Ageing of MLC

Ageing

Capacitor ageing is a term used to describe the negative, logarithmic capacitance change which takes place in ceramic capacitors with time. The crystalline structure for barium titanate based ceramics changes on passing through its Curie temperature (known as the Curie Point) at about 125°C. This domain structure relaxes with time and in doing so, the dielectric constant reduces logarithmically; this is known as the ageing mechanism of the dielectric constant. The more stable dielectrics have the lowest ageing rates.

The ageing process is reversible and repeatable. Whenever the capacitor is heated to a temperature above the Curie Point the ageing process starts again from zero.

The ageing constant, or ageing rate, is defined as the percentage loss of capacitance due to the ageing process of the dielectric which occurs during a decade of time (a tenfold increase in age) and is expressed as percent per logarithmic decade of hours. As the law of decrease of capacitance is logarithmic, this means that in a capacitor with an ageing rate of 1% per decade of time, the capacitance will decrease at a rate of:

- 1% between 1 and 10 hours
- An additional 1% between the following 10 and 100 hours
- An additional 1% between the following 100 and 1000 hours
- An additional 1% between the following 1000 and 10000 hours etc
- The ageing rate continues in this manner throughout the capacitor's life.

Typical values of the ageing constant for our Multilayer Ceramic Capacitors are:

Dielectric class	Typical values
Ultra Stable COG/NP0 (1B)	Negligible capacitance loss through ageing
Stable X7R (2R1)	<2% per decade of time

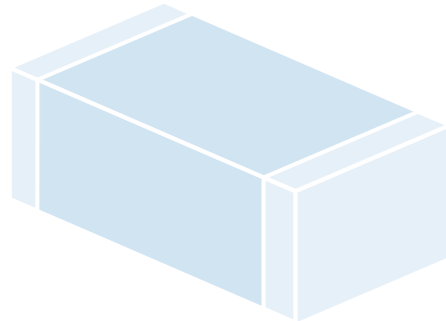

Capacitance measurements

Because of ageing it is necessary to specify an age for reference measurements at which the capacitance shall be within the prescribed tolerance. This is fixed at 1000 hours, since for practical purposes there is not much further loss of capacitance after this time.

All capacitors shipped are within their specified tolerance at the standard reference age of 1000 hours after having cooled through their Curie temperature.

The ageing curve for any ceramic dielectric is a straight line when plotted on semi-log paper.

Capacitance vs time

(Ageing X7R (2R1) @ <2% per decade)

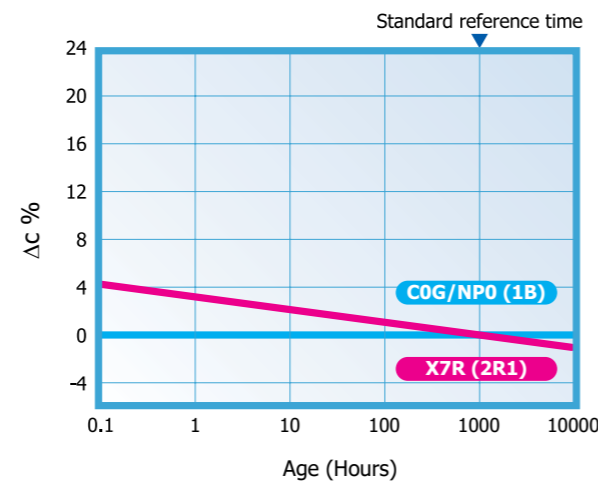

Tight tolerance

One of the advantages of Knowles' unique 'wet process' of manufacture is the ability to offer capacitors with exceptionally tight capacitance tolerances.

The accuracy of the printing screens used in the fully automated, computer controlled manufacturing process allows for tolerance as close as +/-1% on COG/NP0 (1B) parts greater than or equal to 10pF. For capacitance values below <4.7pF, tolerances can be as tight as +/-0.05pF.

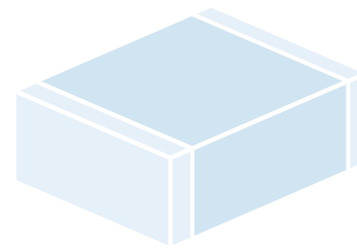

Mounting, Soldering, Storage & Mechanical Precautions

Knowles Precision Devices (KPD) MLCCs are compatible with all recognised soldering / mounting methods for chip capacitors.

Mechanical considerations for mounting MLCCs

Due to their brittle nature, ceramic chip capacitors are more prone to excesses of mechanical stress than other components used in surface mounting.

One of the most common causes of failure is directly attributable to bending the printed circuit board after solder attachment. The excessive or sudden movement of the flexible circuit board stresses the inflexible ceramic block causing a crack to appear at the weakest point, usually the ceramic/termination interface. The crack may initially be quite small and not penetrate into the inner electrodes; however, subsequent handling and rapid changes in temperature may cause the crack to enlarge.

This mode of failure is often invisible to normal inspection techniques as the resultant cracks usually lie under the capacitor terminations but if left, can lead to catastrophic failure. More importantly, mechanical cracks, unless they are severe may not be detected by normal electrical testing of the completed circuit, failure only occurring at some later stage after moisture ingress.

The degree of mechanical stress generated on the printed circuit board is dependent upon several factors including the board material and thickness; the amount of solder and land pattern. The amount of solder applied is important, as an excessive amount reduces the chip's resistance to cracking.

It is Knowles' experience that more than 90% are due to board depanelisation, a process where two or more circuit boards are separated after soldering is complete. Other manufacturing stages that should be reviewed include:

- 1) Attaching rigid components such as connectors, relays, display panels, heat sinks etc.
- 2) Fitting conventional leaded components. Special care must be exercised when rigid terminals, as found on large can electrolytic capacitors, are inserted.
- 3) Storage of boards in such a manner which allows warping.
- 4) Automatic test equipment, particularly the type employing "bed of nails" and support pillars.
- 5) Positioning the circuit board in its enclosure especially where this is a "snap-fit".

Knowles were the first MLCC manufacturer to launch a flexible termination to significantly reduce the instances of mechanical cracking. FlexiCap™ termination introduces a certain amount of give into the termination layer absorbing damaging stress. Unlike similar systems, FlexiCap™ does not tear under tension, but absorbs the stress, so maintaining the characteristics of the MLCC.

SM Pad Design

Knowles conventional 2-terminal chip capacitors can generally be mounted using pad designs in accordance with IPC-7351, Generic Requirements for Surface Mount Design and Land Pattern Standards, but there are some other factors that have been shown to reduce mechanical stress, such as reducing the pad width to less than the chip width. In addition, the position of the chip on the board should also be considered.

3-Terminal components are not specifically covered by IPC-7351, but recommended pad dimensions are included in the Knowles catalogue / website for these components.

Soldering surface mount chip capacitors

Please see application note AN0028 "Soldering / Mounting Chip Capacitors, Radial Leaded Capacitors and EMI Filters" located at: <http://www.knowlescapacitors.com/Resources.aspx?tab=mlc§ion=mlcAN>

The volume of solder applied to the chip capacitor can influence the reliability of the device. Excessive solder can create thermal and tensile stresses on the component which can lead to fracturing of the chip or the solder joint itself. Insufficient or uneven solder application can result in weak bonds, rotation of the device off line or lifting of one terminal off the pad (tombstoning). The volume of solder is process and board pad size dependent.

Soldering methods commonly used in industry are Reflow Soldering, Wave Soldering and, to a lesser extent, Vapour Phase Soldering. All these methods involve thermal cycling of the components and therefore the rate of heating and cooling must be controlled to preclude thermal shocking of the devices.

Without mechanical restriction, thermally induced stresses are released once the capacitor attains a steady state condition. Capacitors bonded to substrates, however, will retain some stress, due primarily to the mismatch of expansion of the component to the substrate; the residual stress on the chip is also influenced by the ductility and hence the ability of the bonding medium to relieve the stress. Unfortunately, the thermal expansion of chip capacitors differ significantly from those of most substrate materials.

Large chips are more prone to thermal shock as their greater bulk will result in sharper thermal gradients within the device during thermal cycling. Large units experience excessive stress if processed through the fast cycles typical of solder wave or vapour phase operations.

Reflow soldering Surface Mount Chip Capacitors

Knowles recommend reflow soldering as the preferred method for mounting MLCCs. KPD MLCCs can be reflow soldered using a reflow profile generally as defined in IPC / JEDEC J-STD-020. Sn plated termination chip capacitors are compatible with both conventional and lead free soldering, with peak temperatures of 260°C to 270°C acceptable.

The heating ramp rate should be such that components see a temperature rise of 1.5°C to 4°C per seconds to maintain temperature uniformity through the MLCC. The time for which the solder is molten should be maintained at a minimum, so as to prevent solder leaching. Extended times above 230°C can cause problems with oxidation of Sn plating. Use of inert atmosphere can help if this problem is encountered. PdAg terminations can be particularly susceptible to leaching with lead free, tin rich solders and trials are recommended for this combination. Cooling to ambient temperature should be allowed to occur naturally, particularly if larger chip sizes are being soldered. Natural cooling allows a gradual relaxation of thermal mismatch stresses in the solder joints. Forced cooling should be avoided as this can induce thermal breakage.

Wave soldering Surface Mount Chip Capacitors

Wave soldering is generally acceptable, but the thermal stresses caused by the wave have been shown to lead to potential problems with larger or thicker chips. Particular care should be taken when soldering SM chips larger than size 1210 and with a thickness greater than 1.0mm for this reason. 0402 size components are not suitable for wave soldering. 0402 size components can also be susceptible to termination leaching and reflow soldering is recommended for this size MLCC.

Wave soldering exposes the devices to a large solder volume, hence the pad size area must be restricted to accept an amount of solder which is not detrimental to the chip size utilized. Typically the pad width is 66% of the component width, and the length is .030" (.760mm) longer than the termination band on the chip. An 0805 chip which is .050" wide and has a .020" termination band therefore requires a pad .033" wide by .050" in length. Opposing pads should be identical in size to preclude uneven solder fillets and mismatched surface tension forces which can misalign the device. It is preferred that the pad layout results in alignment of the long axis of the chips at right angles to the solder wave, to promote even wetting of all



Mounting, Soldering, Storage & Mechanical Precautions

terminals. Orientation of components in line with the board travel direction may require dual waves with solder turbulence to preclude cold solder joints on the trailing terminals of the devices, as these are blocked from full exposure to the solder by the body of the capacitor.

The pre-heat ramp should be such that the components see a temperature rise of 1.5°C to 4°C per second as for reflow soldering. This is to maintain temperature uniformity through the MLCC and prevent the formation of thermal gradients within the ceramic. The preheat temperature should be within 120°C maximum (100°C preferred) of the maximum solder temperature to minimise thermal shock. Maximum permissible wave temperature is 270°C for SM chips. Total immersion exposure time for Sn/Ni terminations is 30s at a wave temperature of 260°C. Note that for multiple soldering operations, including the rework, the soldering time is cumulative.

The total immersion time in the solder should be kept to a minimum. It is strongly recommended that plated terminations are specified for wave soldering applications. PdAg termination is particularly susceptible to leaching when subjected to lead free wave soldering and is not generally recommended for this application.

Cooling to ambient temperature should be allowed to occur naturally, particularly if larger chip sizes are being soldered. Natural cooling allows a gradual relaxation of thermal mismatch stresses in the solder joints. Forced cooling should be avoided as this can induce thermal breakage.

Vapour phase soldering Chip Capacitors

Vapour phase soldering can expose capacitors to similar thermal shock and stresses as wave soldering and the advice is generally the same. Particular care should be taken in soldering large capacitors to avoid thermal cracks being induced and natural cooling should be used to allow a gradual relaxation of stresses.

Hand soldering and rework of Chip Capacitors

Attachment using a soldering iron requires extra care and is accepted to have a risk of cracking of the chip. Precautions include preheating of the assembly to within 100°C of the solder flow temperature and the use of a fine tip iron which does not exceed 30 watts. In no circumstances should the tip of the iron be allowed to contact the chip directly.

KPD recommend hot air/gas as the preferred method for applying heat for rework. Apply even heat surrounding the component to minimise internal thermal gradients.

Minimise the rework heat duration and allow components to cool naturally after soldering.

Solder leaching

Leaching is the term for the dissolution of silver into the solder causing a failure of the termination system which causes increased ESR, $\tan \delta$ and open circuit faults, including ultimately the possibility of the chip becoming detached. Leaching occurs more readily with higher temperature solders and solders with a high tin content. Pb free solders can be very prone to leaching certain termination systems. To prevent leaching, exercise care when choosing solder alloys and minimize both maximum temperature and dwell time with the solder molten.

Plated terminations with nickel or copper anti leaching barrier layers are available in a range of top coat finishes to prevent leaching occurring. These finishes also include Syfer FlexiCap™ for improved stress resistance post soldering.

Bonding

Hybrid assembly using conductive epoxy or wire bonding requires the use of silver palladium or gold terminations. Nickel barrier termination is not practical in these applications, as intermetallics will form between the dissimilar metals. The ESR will increase over time and may eventually break contact when exposed to temperature cycling.

Cleaning

Chip capacitors can withstand common agents such as water, alcohol and degreaser solvents used for cleaning boards. Ascertain that no flux residues are left on the chip surfaces as these diminish electrical performance.

Handling

Ceramics are dense, hard, brittle and abrasive materials. They are liable to suffer mechanical damage, in the form of chips or cracks, if improperly handled.

Terminations may be abraded onto chip surfaces if loose chips are tumbled in bulk. Metallic tracks may be left on the chip surfaces which might pose a reliability hazard.

Components should never be handled with fingers; perspiration and skin oils can inhibit solderability and will aggravate cleaning.

Chip capacitors should never be handled with metallic instruments. Metal tweezers should never be used as these can chip the product and may leave abraded metal tracks on the product surface. Plastic or plastic coated metal types are readily available and recommended - these should be used with an absolute minimum of applied pressure.

Counting or visual inspection of chip capacitors is best performed on a clean glass or hard plastic surface.

If chips are dropped or subjected to rough handling, they should be visually inspected before use. Electrical inspection may also reveal gross damage via a change in capacitance, an increase in dissipation factor or a decrease either in insulation resistance or electrical strength.

Transportation

Where possible, any transportation should be carried out with the product in its unopened original packaging. If already opened, any environmental control agents supplied should be returned to packaging and the packaging re-sealed.

Avoid paper and card as a primary means of handling, packing, transportation and storage of loose components. Many grades have a sulphur content which will adversely affect termination solderability.

Loose chips should always be packed with sulphur-free wadding to prevent impact or abrasion damage during transportation.

Storage

Incorrect storage of components can lead to problems for the user. Rapid tarnishing of the terminations, with an associated degradation of solderability, will occur if the product comes into contact with industrial gases such as sulphur dioxide and chlorine. Storage in free air, particularly moist or polluted air, can result in termination oxidation.

Packaging should not be opened until the MLCs are required for use. If opened, the pack should be re-sealed as soon as is practicable. Alternatively, the contents could be kept in a sealed container with an environmental control agent.

Long term storage conditions, ideally, should be temperature controlled between -5 and +40°C and humidity controlled between 40 and 60% R.H.

Taped product should be stored out of direct sunlight, which might promote deterioration in tape or adhesive performance.

Product, stored under the conditions recommended above, in its "as received" packaging, has a minimum shelf life of 2 years.

Ceramic Chip Capacitors - Packaging information

Tape and reel packing of surface mounting chip capacitors for automatic placement are in accordance with IEC60286-3.

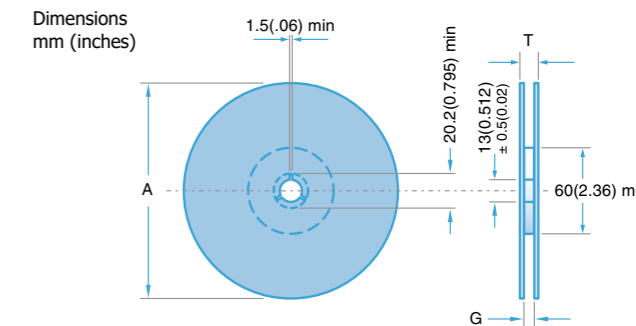
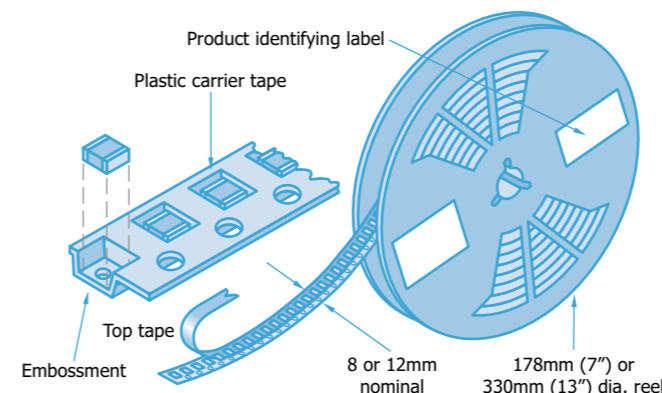

Symbol	Description	178mm reel	330mm reel
A	Diameter	178 (7)	330 (13)
G	Inside width	8.4 (0.33)	12.4 (0.49)
T	Outside width	14.4 (0.56) max	18.4 (0.72) max

Peel force

The peel force of the top sealing tape is between 0.2 and 1.0 Newton at 180°. The breaking force of the carrier and sealing tape in the direction of unreeling is greater than 10 Newtons.

Identification

Each reel is labelled with the following information: manufacturer, chip size, capacitance, tolerance, rated voltage, dielectric type, batch number, date code and quantity of components.

Missing components

Maximum number of missing components shall be 1 per reel or 0.025% whichever is greater. There shall not be consecutive components missing from any reel for any reason.

Tape dimensions

Leader and Trailer

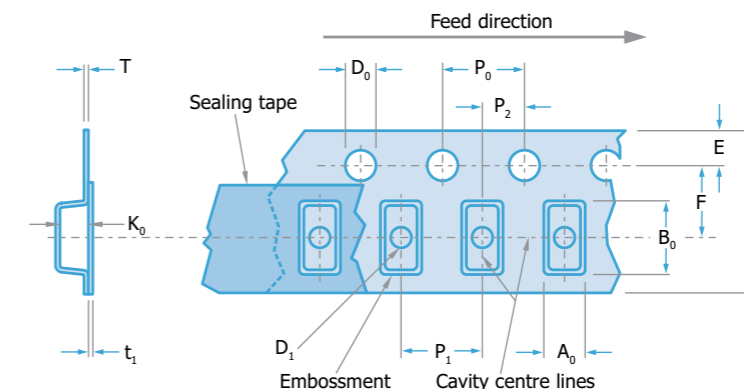
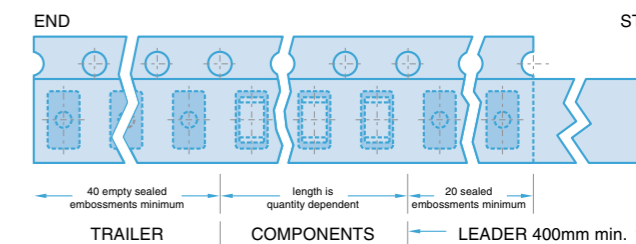

Symbol	Description	Dimensions mm (inches)	
		8mm tape	12mm tape
A ₀	Width of cavity	Dependent on chip size to minimize rotation	
B ₀	Length of cavity	Dependent on chip size to minimize rotation	
K ₀	Depth of cavity	Dependent on chip size to minimize rotation	
W	Width of tape	8.0 (0.315)	12.0 (0.472)
F	Distance between drive hole centres and cavity centres	3.5 (0.138)	5.5 (0.213)
E	Distance between drive hole centres and tape edge	1.75 (0.069)	
P ₁	Distance between cavity centres	4.0 (0.156)	8.0 (0.315)
P ₂	Axial distance between drive hole centres and cavity centres	2.0 (0.079)	
P ₀	Axial distance between drive hole centres	4.0 (0.156)	
D ₀	Drive hole diameter	1.5 (0.059)	
D ₁	Diameter of cavity piercing	1.0 (0.039)	1.5 (0.059)
T	Carrier tape thickness	0.3 (0.012) ± 0.1 (0.004)	0.4 (0.016) ± 0.1 (0.004)
t ₁	Top tape thickness	0.1 (0.004) max	

Ceramic Chip Capacitors - Packaging information

Component orientation

Tape and reeling is in accordance with IEC 60286 part 3, which defines the packaging specifications of lead less components on continuous tapes.

- Notes: 1) IEC60286-3 states $A_0 \leq B_0$ (see tape dimensions on page 13).
 2) Regarding the orientation of 1825 and 2225 components, the termination bands are right to left, NOT front to back. Please see diagram.

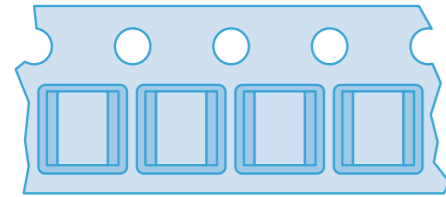

Orientation of 1825 & 2225 components

Outer Packaging

Outer carton dimensions mm (inches) max.

Reel Size	No. of reels	L	W	T
178 (7.0)	1	185 (7.28)	185 (7.28)	25 (0.98)
178 (7.0)	4	190 (7.48)	195 (7.76)	75 (2.95)
330 (13.0)	1	335 (13.19)	335 (13.19)	25 (0.98)

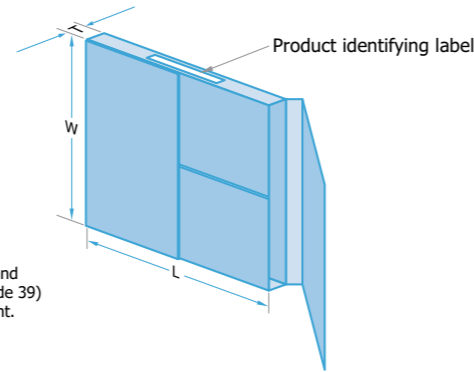

Note: Labelling of box and reel with bar codes (Code 39) available by arrangement.

Maximum reel quantities

Chip size	0402	0603	0805	1206	1210	1210 Suffix AG1	1808	1812	1825	2211	2215	2220	2225	3640	5550	8060
Reel quantities																
178mm (7")	10k	4000	3000	2500	2000	1500	1500	500	500	750	500	500	500	-	-	-
330mm (13")	15k	16k	12k	10k	8000	6000	6000	2000	2000	4000	2000	2000	2000	500	-	-

Bulk packaging, tubs

Chips can be supplied in rigid re-sealable plastic tubs together with impact cushioning wadding. Tubs are labelled with the details: chip size, capacitance, tolerance, rated voltage, dielectric type, batch number, date code and quantity of components.

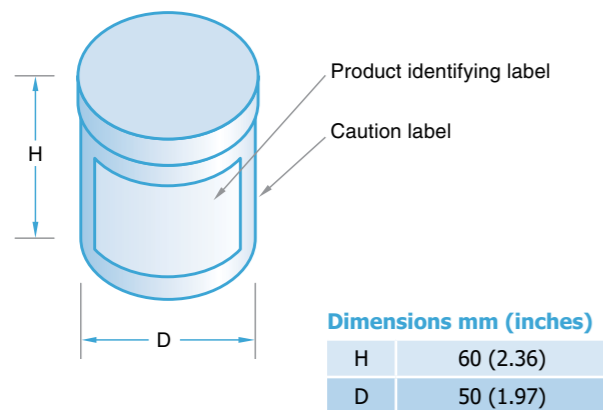

Dimensions mm (inches)

H	60 (2.36)
D	50 (1.97)

Chip dimensions

- For maximum chip thicknesses, refer to individual range tables in this catalogue.
- Non-standard thicknesses are available – consult your local KPD Sales Office.
- For special ranges, e.g. Surface Mount EMI Filters, dimensions may vary. See individual catalogue page.

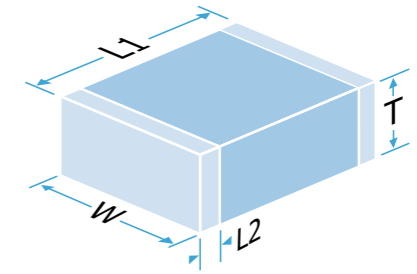

Size	Length (L1) Parts with standard termination mm (inches)	Length (L1) Parts with polymer termination mm (inches)	Width (w) mm (inches)	Termination Band (L2)	
				Minimum mm (inches)	Maximum mm (inches)
0402	1.0 ± 0.10 (0.040 ± 0.004)	1.0 +0.20/-0.10 (0.04 +0.008/-0.004)	0.50 ± 0.10 (0.02 ± 0.004)	0.10 (0.004)	0.40 (0.016)
0603	1.6 ± 0.15 (0.063 ± 0.006)	1.6 +0.25/-0.15 (0.063 +0.01/-0.006)	0.8 ± 0.15 (0.032 ± 0.006)	0.20 (0.004)	0.40 (0.016)
0805	2.0 ± 0.20 (0.079 ± 0.008)	2.0 +0.30/-0.20 (0.079 +0.012/-0.008)	1.25 ± 0.20 (0.049 ± 0.008)	0.25 (0.01)	0.75 (0.030)
1206	3.2 ± 0.20 (0.126 ± 0.008)	3.2 +0.30/-0.20 (0.126 +0.012/-0.008)	1.6 ± 0.20 (0.063 ± 0.008)	0.25 (0.01)	0.75 (0.030)
1210	3.2 ± 0.20 (0.126 ± 0.008)	3.2 +0.30/-0.20 (0.126 +0.012/-0.008)	2.5 ± 0.20 (0.098 ± 0.008)	0.25 (0.01)	0.75 (0.030)
1808	4.5 ± 0.35 (0.180 ± 0.014)	4.5 +0.45/-0.35 (0.180 +0.018/-0.014)	2.0 ± 0.30 (0.08 ± 0.012)	0.25 (0.01)	1.0 (0.04)
1812	4.5 ± 0.30 (0.180 ± 0.012)	4.5 +0.40/-0.30 (0.180 +0.016/-0.012)	3.2 ± 0.20 (0.126 ± 0.008)	0.25 (0.01)	1.143 (0.045)
1825	4.5 ± 0.30 (0.180 ± 0.012)	4.5 +0.40/-0.30 (0.180 +0.016/-0.012)	6.40 ± 0.40 (0.252 ± 0.016)	0.25 (0.01)	1.0 (0.04)
2211	5.7 ± 0.40 (0.225 ± 0.016)	5.7 +0.50/-0.40 (0.225 +0.02/-0.016)	2.79 ± 0.30 (0.11 ± 0.012)	0.25 (0.01)	0.8 (0.03)
2220	5.7 ± 0.40 (0.225 ± 0.016)	5.7 +0.50/-0.40 (0.225 +0.02/-0.016)	5.0 ± 0.40 (0.197 ± 0.016)	0.25 (0.01)	1.0 (0.04)
2225	5.7 ± 0.40 (0.225 ± 0.016)	5.7 +0.50/-0.40 (0.225 +0.02/-0.016)	6.30 ± 0.40 (0.252 ± 0.016)	0.25 (0.01)	1.143 (0.045)
3640	9.2 ± 0.50 (0.360 ± 0.02)	9.2 +0.60/-0.50 (0.36 +0.024/-0.02)	10.16 ± 0.50 (0.40 ± 0.02)	0.50 (0.02)	1.50 (0.06)
5550	14.0 ± 0.711 (0.550 ± 0.028)	14.0 +0.811/-0.711 (0.550 +0.032/-0.028)	12.7 ± 0.635 (0.500 ± 0.025)	0.50 (0.02)	1.50 (0.06)
8060	20.3 ± 0.5 (0.800 ± 0.02)	20.3 +0.60/-0.50 (0.80 +0.024/-0.02)	15.24 ± 0.50 (0.60 ± 0.02)	0.50 (0.02)	1.50 (0.06)

COG/NPO (1B) - AEC-Q200 & Standard ranges

10V to 12kVdc

COG/NPO (1B) - AEC-Q200 & Standard ranges - capacitance values

	COG/NPO (1B)	0402	0603	0805	1206	1210	1808	1812	1825	2220	2225	3640	5550	8060								
	Part number suffix	-	-	-	-	-	AG1	-	-	U99	-	U99	-	U99								
	Maximum Thickness	0.61mm	0.8mm	1.37mm	1.7mm	2.0mm	2.2mm	2.0mm	2.5mm	3.2mm	2.5mm	3.2mm	2.5mm	4.0mm	2.5mm	4.0mm	2.5mm	4.0mm	2.5mm	4.0mm	2.5mm	4.0mm
10V	Standard	-	0.5pF - 3.9nF	1pF - 15nF	1pF - 47nF	3.9pF - 100nF	-	4.7pF - 100nF	10pF - 220nF	-	10pF - 470nF	-	10pF - 560nF	-	-	-	-	-	-	-	-	-
16V	AEC-Q200	-	0.5pF - 1nF	1pF - 4.7nF	1pF - 15nF	3.9pF - 27nF	-	4.7pF - 27nF	10pF - 47nF	-	10pF - 82nF	-	10pF - 100nF	-	10pF - 150nF	-	10pF - 220nF	-	-	-	-	-
	Standard	-	0.5pF - 2.7nF	1pF - 12nF	1pF - 33nF	3.9pF - 68nF	-	4.7pF - 68nF	10pF - 180nF	-	10pF - 330nF	-	10pF - 330nF	-	10pF - 470nF	-	-	-	-	-	-	-
25V	AEC-Q200	-	0.5pF - 1nF	1pF - 4.7nF	1pF - 15nF	3.9pF - 27nF	-	4.7pF - 27nF	10pF - 47nF	-	10pF - 82nF	-	10pF - 100nF	-	10pF - 150nF	-	10pF - 220nF	-	-	-	-	-
	Standard	0.2pF - 220pF	0.5pF - 2.2nF	1pF - 10nF	1pF - 27nF	3.9pF - 56nF	-	4.7pF - 47nF	10pF - 150nF	-	10pF - 220nF	-	10pF - 220nF	-	10pF - 330nF	-	-	-	-	-	-	-
50/63V	AEC-Q200	-	0.5pF - 1nF	1pF - 4.7nF	1pF - 15nF	3.9pF - 27nF	-	4.7pF - 27nF	10pF - 47nF	-	10pF - 82nF	-	10pF - 100nF	-	10pF - 150nF	-	10pF - 220nF	-	-	-	-	-
	Standard	0.2pF - 220pF	0.5pF - 1.5nF	1pF - 5.6nF	1pF - 22nF	3.9pF - 33nF	-	4.7pF - 33nF	10pF - 100nF	-	10pF - 150nF	-	10pF - 150nF	-	10pF - 220nF	-	10pF - 330nF	-	27pF - 680nF	-	47pF - 1µF	-
100V	AEC-Q200	-	0.5pF - 470pF	1pF - 2.2nF	1pF - 8.2nF	3.9pF - 15nF	-	4.7pF - 15nF	10pF - 39nF	-	10pF - 47nF	-	10pF - 56nF	-	10pF - 68nF	-	10pF - 180nF	-	-	-	-	-
	Standard	0.2pF - 100pF	0.5pF - 470pF	1pF - 2.2nF	1pF - 8.2nF	3.9pF - 18nF	-	4.7pF - 18nF	10pF - 47nF	-	10pF - 68nF	-	10pF - 68nF	-	10pF - 82nF	-	10pF - 270nF	-	27pF - 470nF	-	47pF - 680nF	-
200/250V	AEC-Q200	-	0.5pF - 220pF	1pF - 1.5nF	1pF - 3.9nF	3.9pF - 8.2nF	-	4.7pF - 8.2nF	10pF - 18nF	22nF - 22nF	10pF - 27nF	33nF - 33nF	10pF - 33nF	39nF - 39nF	10pF - 33nF	39nF - 47nF	10pF - 82nF	-	-	-	-	-
	Standard	0.2pF - 33pF	0.5pF - 220pF	1pF - 1.5nF	1pF - 3.9nF	3.9pF - 8.2nF	-	4.7pF - 8.2nF	10pF - 22nF	27nF - 27nF	10pF - 33nF	39nF - 47nF	10pF - 33nF	39nF - 56nF	10pF - 47nF	56nF - 68nF	10pF - 120nF	150nF - 180nF	27pF - 270nF	330nF - 330nF	47pF - 390nF	470nF - 560nF
500V	AEC-Q200	-	-	1pF - 1.0nF	1pF - 3.3nF	3.9pF - 6.8nF	-	4.7pF - 6.8nF	10pF - 15nF	18nF - 22nF	10pF - 18nF	22nF - 33nF	10pF - 27nF	33nF - 39nF	10pF - 33nF	39nF - 47nF	10pF - 56nF	-	-	-	-	-
	Standard	-	0.5pF - 150pF	1pF - 1.5nF	1pF - 3.3nF	3.9pF - 6.8nF	-	4.7pF - 6.8nF	10pF - 15nF	18nF - 22nF	10pF - 15nF	18nF - 22nF	10pF - 27nF	33nF - 39nF	10pF - 33nF	39nF - 47nF	10pF - 82nF	100nF - 120nF	27pF - 180nF	220nF - 270nF	47pF - 270nF	330nF - 470nF
630V	AEC-Q200	-	-	10pF - 820pF	1pF - 2.7nF	3.9pF - 5.6nF	6.8nF - 6.8nF	4.7pF - 6.8nF	10pF - 15nF	18nF - 22nF	10pF - 10nF	12nF - 33nF	10pF - 27nF	33nF - 39nF	10pF - 18nF	-	10pF - 39nF	-	-	-	-	-
	Standard	-	-	1pF - 820pF	1pF - 2.7nF	3.9pF - 5.6nF	6.8nF - 6.8nF	4.7pF - 6.8nF	10pF - 15nF	18nF - 22nF	10pF - 22nF	27nF - 33nF	10pF - 27nF	33nF - 39nF	10pF - 22nF	27nF - 39nF	10pF - 68nF	82nF - 100nF	27pF - 120nF	150nF - 180nF	47pF - 220nF	270nF - 390nF
1kV	AEC-Q200	-	-	10pF - 330pF	1pF - 2.2nF	3.9pF - 3.9nF	-	4.7pF - 3.9nF	10pF - 6.8nF	8.2nF - 10nF	10pF - 10nF	12nF - 22nF	10pF - 15nF	18nF - 22nF	10pF - 18nF	-	10pF - 22nF	-	-	-	-	-
	Standard	-	-	1pF - 330pF	1pF - 2.2nF	3.9pF - 3.9nF	-	4.7pF - 3.9nF	10pF - 6.8nF	8.2nF - 10nF	10pF - 12nF	15nF - 22nF	10pF - 15nF	18nF - 22nF	10pF - 18nF	22nF - 27nF	10pF - 47nF	56nF - 82nF	27pF - 82nF	100nF - 150nF	47pF - 150nF	180nF - 270nF
1.2kV	AEC-Q200	-	-	10pF - 68pF	1pF - 390pF	3.9pF - 680pF	-	4.7pF - 1.0nF	10pF - 3.3nF	-	10pF - 4.7nF	-	10pF - 5.6nF	-	10pF - 6.8nF	-	10pF - 18nF	-	-	-	-	-
	Standard	-	-	1pF - 120pF	1pF - 680pF	3.9pF - 1.5nF	-	4.7pF - 1.5nF	10pF - 4.7nF	5.6nF - 6.8nF	10pF - 6.8nF	8.2nF - 10nF	10pF - 10nF	12nF - 15nF	10pF - 12nF	15nF - 22nF	10pF - 33nF	39nF - 56nF	27pF - 68nF	82nF - 100nF	47pF - 100nF	120nF - 180nF
1.5kV	AEC-Q200	-	-	10pF - 68pF	1pF - 390pF	3.9pF - 680pF	-	4.7pF - 680pF	10pF - 2.2nF	-	10pF - 3.9nF	-	10pF - 5.6nF	-	10pF - 6.8nF	-	10pF - 12nF	-	-	-	-	-
	Standard	-	-	1pF - 82pF	1pF - 390pF	3.9pF - 820pF	-	4.7pF - 1nF	10pF - 2.7nF	3.3nF - 3.3nF	10pF - 4.7nF	5.6nF - 6.8nF	10pF - 5.6nF	6.8nF - 10nF	10pF - 6.8nF	8.2nF - 12nF	10pF - 22nF	27nF - 39nF	27pF - 39nF	47nF - 68nF	47pF - 68nF	82nF - 120nF
2kV	AEC-Q200	-	-	10pF - 47pF	1pF - 220pF	3.9pF - 470pF	-	4.7pF - 470pF	10pF - 1.5nF	-	10pF - 1.8nF	-	10pF - 2.2nF	-	10pF - 3.9nF	-	10pF - 5.6nF	-	-	-	-	-
	Standard	-	-	1pF - 47pF	1pF - 220pF	3.9pF - 470pF	-	4.7pF - 470pF	10pF - 1.5nF	1.8nF - 1.8nF	10pF - 2.7nF	3.3nF - 3.9nF	10pF - 3.3nF	3.9nF - 5.6nF	10pF - 4.7nF	5.6nF - 6.8nF	10pF - 10nF	12nF - 18nF	27pF - 22nF	27nF - 39nF	47pF - 39nF	47nF - 68nF
2.5kV	AEC-Q200	-	-	-	10pF - 100pF	22pF - 180pF	-	22pF - 270pF	47pF - 680pF	-	68pF - 1.2nF	-	68pF - 1.5nF	-	100pF - 2.7nF	-	-	-	-	-	-	-
	Standard	-	-	-	1pF - 100pF	3.9pF - 220pF	-	4.7pF - 270pF	10pF - 820pF	1.0nF - 1.0nF	10pF - 1.5nF	1.8nF - 2.2nF	10pF - 1.8nF	2.2nF - 3.3nF	10pF - 2.7nF	3.3nF - 3.9nF	10pF - 6.8nF	8.2nF - 12nF	27pF - 12nF	15nF - 22nF	47pF - 22nF	27nF - 39nF
3kV	AEC-Q200	-	-	-	10pF - 68pF	22pF - 150pF	-	22pF - 220pF	47pF - 470pF	-	68pF - 820pF	-	68pF - 1.0nF	-	100pF - 1.5nF	1.8nF - 2.2nF	-	-	-	-	-	-
	Standard	-	-	-	1pF - 68pF	3.9pF - 150pF	-	4.7pF - 220pF	10pF - 560pF	680pF - 680pF	10pF - 1.2nF	1.5nF - 1.5nF	10pF - 1.5nF	1.8nF - 2.2nF	10pF - 1.8nF	2.2nF - 2.7nF	10pF - 4.7nF	5.6nF - 8.2nF	27pF - 10nF	12nF - 18nF	47pF - 15nF	18nF - 27nF
4kV*	Standard	-	-	-	-	-	-	4.7pF - 120pF	10pF - 270pF	330pF - 390pF	10pF - 560pF	680pF - 680pF	10pF - 680pF	820pF - 1.2nF	10pF - 820pF	1nF - 1.5nF	10pF - 1.8nF	2.2nF - 3.3nF	27pF - 4.7nF	5.6nF - 6.8nF	47pF - 8.2nF	10nF - 15nF
5kV*	Standard	-	-	-	-	-	-	4.7pF - 68pF	10pF - 180pF	220pF - 270pF	10pF - 390pF	470pF - 470pF	10pF - 470pF	560pF - 820pF	10pF - 560pF	680pF - 1nF	10pF - 1.5nF	1.8nF - 2.2nF	27pF - 2.7nF	3.3nF - 4.7nF	47pF - 5.6nF	6.8nF - 10nF
6kV*	Standard	-	-	-	-	-	-	4.7pF - 47pF	10pF - 120pF	150pF - 180pF	10p - 270pF	330pF - 330pF	10pF - 330pF	390p - 560pF	10p - 390pF	470pF - 680pF	10pF - 1nF	1.2nF - 1.5nF	27pF - 1.8nF	2.2nF - 3.3nF	47pF - 3.9nF	4.7nF - 6.8nF
8kV*	Standard	-	-	-	-	-	-	-	-	-	-	-	-	-	-	10pF - 150pF	-	27pF - 330pF	-	47pF - 680pF	-	
10kV*	Standard	-	-	-	-	-	-	-	-	-	-	-	-	-	-	10p - 100pF	-	27pF - 180pF	-	47pF - 470pF	-	
12kV*	Standard	-	-	-	-	-	-	-	-	-	-	-	-	-	-	10p - 68pF	-	27pF - 120pF	-	47pF - 220pF	-	

Notes: 1) *Parts rated 4kV and above may require conformal coating post soldering.
2) AG1 and U99 suffix parts maximise capacitance through increased chip thickness.

X7R (2R1) - AEC-Q200 & Standard ranges

16V to 12kVdc

X7R (2R1) - AEC-Q200 & Standard ranges - capacitance values

	X7R (2R1)	0402	0603	0805	1206	1210	1808	1812	1825	2220	2225	3640	5550	8060								
Part number suffix	-	-	-	-	-	NC	-	NC	-	NC	WS2	-	-	NC	WS2	-	-	WS2	-	-		
Maximum Thickness	0.61mm	0.8mm	0.9mm	1.37mm	1.7mm	1.7mm	2.0mm	2.0mm	2.0mm	2.0mm	2.5mm	2.5mm	3.2mm	2.5mm	2.5mm	4.5mm	2.5mm	2.5mm	4.5mm	2.5mm	2.5mm	
16V	AEC-Q200	-	-	-	220pF - 100nF	220pF - 470nF	-	10nF - 10µF	-	1nF - 470nF	-	1nF - 680nF	-	-	-	1nF - 1.5µF	-	-	-	-	-	-
	Standard	-	100pF - 100nF	-	100pF - 330nF	100pF - 1µF	-	100pF - 1.5µF	-	100pF - 1.5µF	-	150pF - 3.3µF	-	-	220pF - 4.7µF	220pF - 5.6µF	-	-	330pF - 6.8µF	-	-	-
25V	AEC-Q200	-	-	-	220pF - 100nF	220pF - 470nF	-	10nF - 10µF	-	1nF - 470nF	-	1nF - 680nF	-	-	-	1nF - 1.5µF	-	-	-	-	-	-
	Standard	47pF - 10nF	100pF - 100nF	-	100pF - 220nF	100pF - 820nF	-	100pF - 1.2µF	-	100pF - 1.2µF	-	150pF - 2.2µF	-	-	220pF - 3.9µF	220pF - 4.7µF	-	-	330pF - 5.6µF	-	-	-
50/63V	AEC-Q200	-	100pF - 47nF	56nF - 100nF	100pF - 220nF	100pF - 470nF	-	100pF - 10µF	-	100pF - 680nF	-	150pF - 2.2µF	-	-	220pF - 2.2µF	220pF - 3.3µF	-	-	330pF - 3.3µF	470pF - 4.7µF	-	-
	Standard	47pF - 5.6nF	100pF - 47nF	56nF - 100nF	100pF - 220nF	100pF - 470nF	-	100pF - 1µF	-	100pF - 680nF	-	150pF - 2.2µF	-	-	220pF - 2.2µF	220pF - 3.3µF	-	-	330pF - 3.3µF	470pF - 10µF	-	1nF - 15µF
100V	AEC-Q200	-	100pF - 33nF	-	100pF - 100nF	100pF - 220nF	-	100pF - 680nF	-	100pF - 560nF	-	150pF - 1µF	-	-	220pF - 1.5µF	220pF - 1.5µF	-	-	330pF - 2.2µF	470pF - 3.3µF	-	-
	Standard	47pF - 3.3nF	100pF - 33nF	-	100pF - 100nF	100pF - 330nF	-	100pF - 680nF	-	100pF - 560nF	-	150pF - 1.5µF	-	-	220pF - 1.5µF	220pF - 2.2µF	-	-	330pF - 2.7µF	470pF - 5.6µF	-	1nF - 10µF
200/250V	AEC-Q200	-	100pF - 10nF	-	100pF - 47nF	100pF - 150nF	-	100pF - 330nF	-	100pF - 270nF	-	150pF - 680nF	-	820nF - 1µF	220pF - 1µF	220pF - 1.5µF	-	-	330pF - 1.5µF	470pF - 1.5µF	-	-
	Standard	47pF - 1nF	100pF - 10nF	-	100pF - 56nF	100pF - 150nF	-	100pF - 330nF	-	100pF - 270nF	-	150pF - 680nF	-	820nF - 1µF	220pF - 1µF	220pF - 1.5µF	-	1.8µF - 2.2µF	330pF - 1.5µF	470pF - 3.3µF	3.9µF - 5.6µF	1nF - 5.6µF
500V	AEC-Q200	-	1.5nF - 22nF	-	100pF - 15nF	100pF - 68nF	-	100pF - 150nF	-	100pF - 150nF	-	150pF - 330nF	-	390nF - 470nF	220pF - 560nF	220pF - 680nF	-	-	330pF - 680nF	470pF - 1µF	-	-
	Standard	-	100pF - 2.2nF	-	100pF - 15nF	100pF - 68nF	-	100pF - 150nF	-	100pF - 150nF	-	150pF - 330nF	-	390nF - 470nF	220pF - 560nF	220pF - 680nF	-	820nF - 1.2µF	330pF - 820nF	470pF - 1µF	1.2µF - 2.7µF	1nF - 1.8µF
630V	AEC-Q200	-	-	-	220pF - 10nF	100pF - 47nF	-	100pF - 100nF	-	100pF - 100nF	-	150pF - 180nF	-	220nF - 330nF	220pF - 180nF	220pF - 470nF	-	390nF - 1µF	330pF - 390nF	470pF - 680nF	-	-
	Standard	-	-	-	100pF - 10nF	100pF - 47nF	-	100pF - 100nF	-	100pF - 100nF	-	150pF - 180nF	-	220nF - 330nF	220pF - 180nF	220pF - 470nF	-	560nF - 1µF	330pF - 390nF	470pF - 680nF	820nF - 2.2µF	1nF - 1.2µF
1kV	AEC-Q200	-	-	-	220pF - 4.7nF	100pF - 12nF	-	100pF - 47nF	-	100pF - 47nF	-	150pF - 100nF	-	120nF - 180nF	220pF - 180nF	220pF - 150nF	-	150nF - 470nF	330pF - 150nF	470nF - 180nF	220nF - 1µF	-
	Standard	-	-	-	100pF - 10nF	100pF - 22nF	-	100pF - 47nF	-	100pF - 47nF	-	150pF - 100nF	-	120nF - 180nF	220pF - 180nF	220pF - 150nF	-	180nF - 470nF	330pF - 150nF	470pF - 180nF	220nF - 1µF	1nF - 390nF
1.2kV	AEC-Q200	-	-	-	-	100pF - 5.6nF	-	100pF - 18nF	-	100pF - 18nF	-	150pF - 33nF	-	-	220pF - 68nF	220pF - 82nF	-	-	330pF - 100nF	470pF - 150nF	-	-
	Standard	-	-	-	-	100pF - 15nF	-	100pF - 18nF	-	100pF - 22nF	-	150pF - 33nF	-	39nF - 100nF	220pF - 68nF	220pF - 82nF	-	100nF - 220nF	330pF - 100nF	470pF - 150nF	180nF - 470nF	1nF - 220nF
1.5kV	AEC-Q200	-	-	-	-	100pF - 5.6nF	-	100pF - 10nF	-	100pF - 10nF	-	150pF - 22nF	-	-	220pF - 47nF	220pF - 68nF	-	-	330pF - 68nF	470pF - 100nF	-	-
	Standard	-	-	-	-	100pF - 10nF	-	100pF - 12nF	-	100pF - 15nF	-	150pF - 22nF	-	27nF - 56nF	220pF - 47nF	220pF - 68nF	-	82nF - 150nF	330pF - 68nF	470pF - 100nF	120nF - 330nF	1nF - 150nF
2kV	AEC-Q200	-	-	-	-	100pF - 2.2nF	2.7nF - 2.7nF	100pF - 4.7nF	5.6nF - 5.6nF	100pF - 4.7nF	-	150pF - 10nF	12nF - 15nF	-	220pF - 10nF	220pF - 27nF	-	-	330pF - 33nF	470pF - 47nF	-	-
	Standard	-	-	-	-	100pF - 2.2nF	2.7nF - 3.3nF	100pF - 4.7nF	5.6nF - 5.6nF	100pF - 4.7nF	5.6nF - 5.6nF	150pF - 10nF	12nF - 15nF	-	220pF - 10nF	220pF - 33nF	-	39nF - 100nF	330pF - 33nF	470pF - 47nF	56nF - 150nF	1nF - 82nF
2.5kV	AEC-Q200	-	-	-	-	100pF - 1.5nF	-	100pF - 4.7nF	1nF - 1.5nF	1.8nF - 2.7nF	150pF - 3.3nF	3.9nF - 10nF	-	220pF - 4.7nF	220pF - 8.2nF	10nF - 18nF	-	-	330pF - 12nF	470pF - 22nF	-	-
	Standard	-	-	-	-	220pF - 2.7nF	-	680pF - 4.7nF	100pF - 1.5nF	1.8nF - 4.7nF	150pF - 3.3nF	3.9nF - 10nF	-	220pF - 6.8nF	220pF - 8.2nF	10nF - 22nF	-	-	330pF - 12nF	470pF - 33nF	-	1nF - 68nF
3kV	AEC-Q200	-	-	-	-	100pF - 1nF	-	100pF - 3.3nF	1nF - 1.2nF	1.5nF - 2.2nF	150pF - 2.7nF	3.3nF - 4.7nF	-	220pF - 2.7nF	220pF - 6.8nF	8.2nF - 15nF	-	-	330pF - 8.2nF	470pF - 18nF	-	-
	Standard	-	-	-	-	220pF - 1.5nF	-	680pF - 3.3nF	100pF - 1.2nF	1.5nF - 3.3nF	150pF - 2.7nF	3.3nF - 4.7nF	-	220pF - 3.9nF	220pF - 6.8nF	8.2nF - 15nF	-	-	330pF - 8.2nF	470pF - 22nF	-	1nF - 47nF
4kV*	AEC-Q200	-	-	-	-	-	-	-	1nF - 1nF	1.2nF - 1.5nF	150pF - 2.2nF	-	-	-	220pF - 4.7nF	5.6nF - 6.8nF	-	-	-	-	-	-
	Standard	-	-	-	-	-	-	-	100pF - 1nF	1.2nF - 2.2nF	150pF - 2.2nF	2.7nF - 3.3nF	-	220pF - 2.2nF	220pF - 4.7nF	5.6nF - 6.8nF	-	-	330pF - 5.6nF	470pF - 6.8nF	-	1nF - 15nF
5kV*	Standard	-	-	-	-	-	-	-	100pF - 680pF	-	150pF - 1.2nF	-	-	220pF - 1.8nF	220pF - 3.9nF	4.7nF - 4.7nF	-	-	330pF - 4.7nF	470pF - 5.6nF	-	1nF - 10nF
6kV*	Standard	-	-	-	-	-	-	-	100pF - 390pF	-	150pF - 1nF	-	-	220pF - 1.5nF	220pF - 2.2nF	-	-	-	330pF - 2.7nF	470pF - 4.7nF	-	1nF - 8.2nF
8kV*	Standard	-	-	-	-	-	-	-	-	-	-	-	-	-	-	-	-	-	470pF - 1.5nF	-	-	1nF - 4.7nF
10kV*	Standard	-	-	-	-	-	-	-	-	-	-	-	-	-	-	-	-	-	470pF - 1nF	-	-	1nF - 2.2nF
12kV*	Standard	-	-	-	-	-	-	-	-	-	-	-	-	-	-	-	-	-	470pF - 820pF	-	-	1nF - 1.2nF

Notes: 1) *Parts rated 4kV and above may require conformal coating post soldering.
 2) WS2 suffix relates to StackiCap™ high capacitance parts.
 3) NC suffix parts maximise capacitance at high voltages. These parts **must** be conformally coated after mounting, especially between the board and the component.
 4) Parts in this range may be dual-use under export control legislation and as such may be subject to export licence restrictions. Please refer to page 9 for more information on the dual-use regulations and contact the Sales office for further information on specific part numbers.

Ordering information - AEC-Q200 ranges

0805	Y	100	0103	K	S	T	---
Chip size	Termination	Voltage	Capacitance in picofarads (pF)	Capacitance tolerance	Dielectric Release codes	Packaging	Suffix code
0603 0805 1206 1210 1808 1812 1825 2220 2225 3640	<p>Y = FlexiCap™ termination base with Ni barrier (100% matte tin plating). RoHS compliant.</p> <p>H = FlexiCap™ termination base with Ni barrier (Tin/lead plating with min. 10% lead). Not RoHS compliant.</p> <p>J = Nickel barrier (100% matte tin plating). RoHS compliant. Lead free.</p> <p>A = Nickel barrier (Tin/lead plating with min. 10% lead). Not RoHS compliant.</p>	<p>016 = 16V 025 = 25V 050 = 50V 063 = 63V 100 = 100V 200 = 200V 250 = 250V 500 = 500V 630 = 630V 1K0 = 1kV 1K2 = 1.2kV 1K5 = 1.5kV 2K0 = 2kV 2K5 = 2.5kV 3K0 = 3kV</p>	<p>First digit is 0. Second and third digits are significant figures of capacitance code. The fourth digit is number of zeros following Example: 0103 = 10nF</p>	<p>F = ±1% G = ±2% J = ±5% K = ±10% M = ±20%</p>	<p>A = COG/NP0 (1B) to AEC-Q200 - original K = COG/NP0 (1B) to AEC-Q200 - recommended E = X7R (2R1) to AEC-Q200 - original S = X7R (2R1) to AEC-Q200 - recommended</p>	<p>T = 178mm (7") reel R = 330mm (13") reel B = Bulk pack - tubs or trays</p>	<p>AG1 = Special Thickness U99 = Special Thickness WS2 = StackiCap™ NC = Conformal coating required</p>
	Note: X7R (2R1) to AEC-Q200 is only available in Y or H termination.			Note: X7R (2R1) parts are available in J, K & M tolerances only.			

Ordering information - Standard ranges

1210	Y	200	0103	K	C	T	---
Chip size	Termination	Voltage	Capacitance in picofarads (pF)	Capacitance tolerance	Dielectric Release codes	Packaging	Suffix code
0402 0603 0805 1206 1210 1808 1812 1825 2220 2225 3640 5550 8060	<p>Y = FlexiCap™ termination base with Ni barrier (100% matte tin plating). RoHS compliant.</p> <p>H = FlexiCap™ termination base with Ni barrier (Tin/lead plating with min. 10% lead). Not RoHS compliant.</p> <p>J = Nickel barrier (100% matte tin plating). RoHS compliant. Lead free.</p> <p>A = Nickel barrier (Tin/lead plating with min. 10% lead). Not RoHS compliant.</p>	<p>010 = 10V 016 = 16V 025 = 25V 050 = 50V 063 = 63V 100 = 100V 200 = 200V 250 = 250V 500 = 500V 630 = 630V 1K0 = 1kV 1K2 = 1.2kV 1K5 = 1.5kV 2K0 = 2kV 2K5 = 2.5kV 3K0 = 3kV 4K0 = 4kV 5K0 = 5kV 6K0 = 6kV 8K0 = 8kV 10K = 10kV 12K = 12kV</p>	<p>First digit is 0. Second and third digits are significant figures of capacitance code. The fourth digit is number of zeros following Example: 0103 = 10nF</p>	<p>F = ±1% G = ±2% J = ±5% K = ±10% M = ±20%</p>	<p>C = COG/NP0 (1B) X = X7R (2R1)</p>	<p>T = 178mm (7") reel R = 330mm (13") reel B = Bulk pack - tubs or trays</p>	<p>AG1 = Special Thickness U99 = Special Thickness WS2 = StackiCap™ NC = Conformal coating required</p>
				Note: X7R (2R1) parts are available in J, K & M tolerances only.	Suffix coded parts only: C = COG/NP0 (1B) - original G = COG/NP0 (1B) - recommended X = X7R (2R1) - original J = X7R (2R1) - recommended		

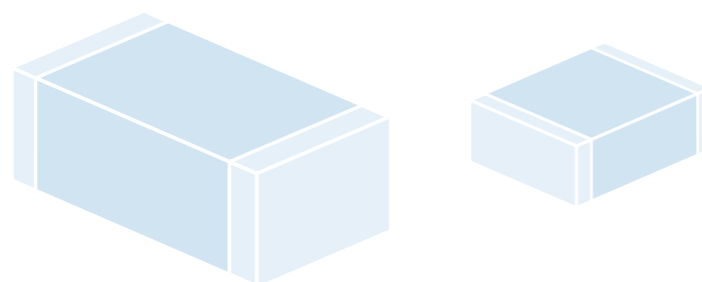

The StackiCap™ range offers a significant reduction in 'PCB real estate' for an equivalent capacitance value when board space is at a premium. For example, a standard 150nF chip in a 8060 case size is now available in a much smaller 3640 case size.

Knowles Precision Devices' unique patented* construction and FlexiCap™ termination material make the StackiCap™ range suitable for applications including: power supplies, lighting, aerospace electronics and high voltage applications where a large amount of capacitance is required.

Further developments are on-going, please contact the Sales Office for details of the full range.

* StackiCap™ technology is protected by international patents (pending) EP2847776, WO2013186172A1, US20150146343A1 and CN104471660A.



Maximum capacitance

Up to 5.6µF

Maximum voltage

Up to 2kV

Capacitance values - StackiCap™ Capacitors

Chip size	1812	2220	3640
Max. Thickness	3.5mm	4.5mm	4.2mm
200/250V	820nF - 1.0µF	1.2µF - 2.2µF	3.9µF - 5.6µF
500V	390nF - 470nF	680nF - 1.2µF	1.2µF - 2.7µF
630V	180nF - 330nF	220nF - 330nF	390nF - 1µF
1kV	120nF - 180nF	150nF - 470nF	220nF - 1µF
1.2kV	39nF - 100nF	100nF - 220nF	180nF - 470nF
1.5kV	27nF - 56nF	56nF - 150nF	120nF - 330nF
2kV	-	39nF - 100nF	56nF - 150nF

Note: = AEC-Q200

Ordering information - StackiCap™ Capacitors

1812	Y	500	0474	K	J	T	WS2
Chip size	Termination	Voltage	Capacitance in picofarads (pF)	Capacitance tolerance	Dielectric	Packaging	Suffix code
1812 2220 3640	<p>Y = FlexiCap™ termination base with nickel barrier (100% matte tin plating). RoHS compliant. Lead free.</p> <p>H = FlexiCap™ Termination base with nickel barrier (Tin/lead plating with minimum 10% lead). Not RoHS compliant.</p>	<p>200 = 200V 250 = 250V 500 = 500V 630 = 630V 1K0 = 1kV 1K2 = 1.2kV 1K5 = 1.5kV 2K0 = 2kV</p>	<p>First digit is 0. Second and third digits are significant figures of capacitance code in picofarads (pF). Fourth digit is number of zeros eg. 0474 = 470nF Values are E12 series</p>	<p>J = ±5% K = ±10% M = ±20%</p>	<p>E = X7R (2R1) to AEC-Q200 X = X7R (2R1)</p>	<p>T = 178mm (7") reel R = 330mm (13") reel B = Bulk pack - tubs or trays</p>	WS2

Reeled quantities - StackiCap™ Capacitors

	1812	2220	3640
178mm (7") Reel	500	500	-
330mm (13") Reel	2,000	2,000	500

Notes: Parts in this range may be defined as dual-use under export control legislation and may be subject to export licence restrictions. Please refer to page 9 for more information on the dual-use regulations and contact the Sales Office for further information on specific part numbers.



250Vac Safety Certified AC Capacitors



a Knowles Precision Devices brand

Safety Certified capacitors comply with international UL and TÜV specifications to offer designers the option of using a surface mount ceramic multilayer capacitor to replace leaded film types. Offering the benefits of simple pick-and-place assembly, reduced board space required and lower profile, they are also available in a FlexiCap™ version to reduce the risk of mechanical cracking.

KPD's high voltage capacitor expertise means the range offers among the highest range available of capacitance values in certain case sizes.

Applications include: modems, AC-DC power supplies and where lightning strike or other voltage transients represent a threat to electronic equipment.

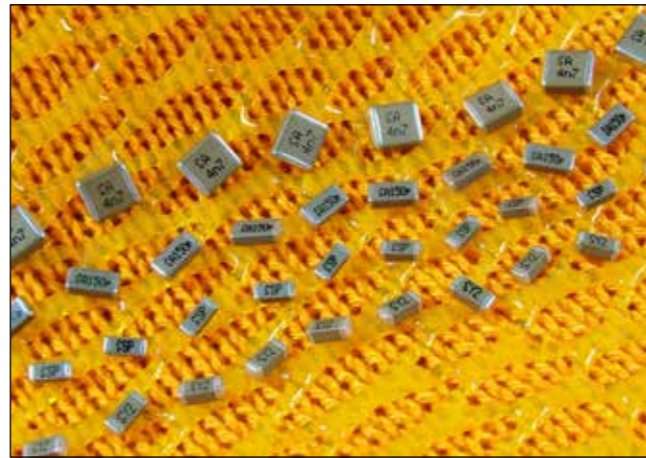

- Surface mount multilayer ceramic capacitors
- Meet Class Y2/X1, X1 and X2 requirements
- Approved for mains ac voltages, up to 250Vac
- Approved by UL and TÜV
- Sizes 1808, 1812, 2211, 2215 and 2220
- Smaller sizes suitable for use in equipment certified to EN60950

- Certification specifications for larger sizes include: IEC/EN60384-14, UL/CSA60950 and UL60384-14
- Surface mount package
- Reduces board area and height restrictions
- Reduced assembly costs over conventional through hole components
- FlexiCap™ option available on all sizes

250Vac Safety Certified Capacitors

Dielectric	Approval Body	X1 PY2		X2 SP	Y2/X1 SP		Y2/X1 B16	X2 B17
		1808	1812		2211	2215		
COG/NP0 (1B)	TÜV, UL	4.7pF - 390pF	4.7pF - 390pF	4.7pF - 1.5nF	4.7pF - 1nF	820pF - 1nF	-	-
X7R (2R1)	TÜV, UL	150pF - 1nF	150pF - 2.2nF	150pF - 4.7nF	100pF - 3.9nF	2.7nF - 3.9nF	150pF - 10nF	150pF - 22nF (TÜV approval only)
Max. thickness		2.0mm	2.5mm	2.0mm	2.54mm	2.54mm	2.54mm*	2.54mm**

Note: ■ = AEC-Q200.
 * = Y2/X1 (B16) 2220 parts with values >5.6nF have a maximum thickness of 4.5mm.
 ** = X2 (B17) 2220 parts with values >10nF have a maximum thickness of 4.0mm.

Class	Rated voltage	Impulse voltage	Insulation bridging	May be used in primary circuit
Y1	250Vac	8000V	Double or reinforced	Line to protective earth
Y2	250Vac	5000V	Basic or supplementary*	Line to protective earth
Y4	150Vac	2500V	Basic or supplementary*	Line to protective earth
X1	250Vac	4000V	-	Line to line
X2	250Vac	2500V	-	Line to line
X3	250Vac	None	-	Line to line

* 2 x Y2 or Y4 rated may bridge double or reinforced insulation when used in series.

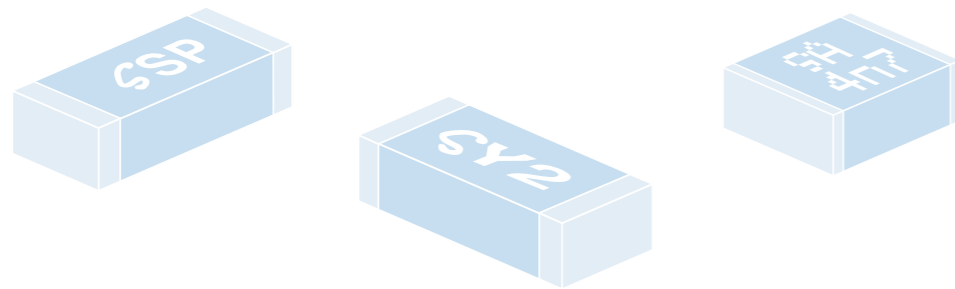

250Vac Safety Certified AC Capacitors



a Knowles Precision Devices brand

Classification and approval specification - Safety Certified capacitors

CHIP SIZE	SUFFIX CODE	DIELECTRIC	CAP RANGE	CLASSIFICATION	APPROVAL SPECIFICATION	APPROVAL BODY	AEC-Q200
1808	SP ⁽¹⁾	COG/NP0 (1B)	4.7pF to 1.5nF	X2 NWGQ2, NWGQ8	IEC60384-14 EN60384-14 UL-60950-1, 2nd Ed CSA 60950-1-07 2nd Ed	TÜV UL	TÜV & UL FULL RANGE
1808	SP ⁽¹⁾	X7R (2R1)	150pF to 4.7nF	X2 NWGQ2, NWGQ8	IEC60384-14 EN60384-14 UL-60950-1, 2nd Ed CSA 60950-1-07 2nd Ed	TÜV UL	TÜV & UL FULL RANGE 'Y' TERM ONLY
1808	PY2 ⁽¹⁾	COG/NP0 (1B)	4.7pF to 390pF	X1 NWGQ2, NWGQ8	IEC60384-14 EN60384-14 UL-60950-1, 2nd Ed CSA 60950-1-07 2nd Ed	TÜV UL	TÜV & UL FULL RANGE
1808	PY2 ⁽¹⁾	X7R (2R1)	150pF to 1nF	X1 NWGQ2, NWGQ8	IEC60384-14 EN60384-14 UL-60950-1, 2nd Ed CSA 60950-1-07 2nd Ed	TÜV UL	TÜV & UL 1nF max. 'Y' TERM ONLY
1812	PY2 ⁽¹⁾	COG/NP0 (1B)	4.7pF to 390pF	X1 NWGQ2, NWGQ8	IEC60384-14 EN60384-14 UL-60950-1, 2nd Ed CSA 60950-1-07 2nd Ed	TÜV UL	TÜV & UL FULL RANGE
1812	PY2 ⁽¹⁾	X7R (2R1)	150pF to 2.2nF	X1 NWGQ2, NWGQ8	IEC60384-14 EN60384-14 UL-60950-1, 2nd Ed CSA 60950-1-07 2nd Ed	TÜV UL	TÜV & UL 2.2nF max. 'Y' TERM ONLY
2211	SP ⁽²⁾	COG/NP0 (1B)	4.7pF to 1nF	Y2/X1 NWGQ2, NWGQ8	IEC60384-14 EN60384-14 UL-60950-1, 2nd Ed CSA 60950-1-07 2nd Ed	TÜV UL	TÜV & UL FULL RANGE
2211	SP ⁽²⁾	X7R (2R1)	100pF to 3.9nF	Y2/X1 NWGQ2, NWGQ8	IEC60384-14 EN60384-14 UL-60950-1, 2nd Ed CSA 60950-1-07 2nd Ed	TÜV UL	TÜV & UL FULL RANGE 'Y' & 'H' TERM ONLY
2215	SP ⁽²⁾	COG/NP0 (1B)	820pF to 1nF	Y2/X1 NWGQ2, NWGQ8	IEC60384-14 EN60384-14 UL-60950-1, 2nd Ed CSA 60950-1-07 2nd Ed	TÜV UL	TÜV & UL FULL RANGE
2215	SP ⁽²⁾	X7R (2R1)	2.7nF to 3.9nF	Y2/X1 NWGQ2, NWGQ8	IEC60384-14 EN60384-14 UL-60950-1, 2nd Ed CSA 60950-1-07 2nd Ed	TÜV UL	TÜV & UL FULL RANGE 'Y' & 'H' TERM ONLY
2220	B16 ⁽³⁾	X7R (2R1)	150pF to 10nF	Y2/X1 FOWX2, FOWX8	IEC60384-14 EN60384-14 UL-60384-14:2010 CSA E60384-14:09	TÜV UL	TÜV & UL FULL RANGE 'Y' & 'H' TERM ONLY
2220	B17 ⁽²⁾	X7R (2R1)	150pF to 22nF	X2	IEC60384-14 EN60384-14	TÜV	TÜV ONLY 22nF max. 'Y' & 'H' TERM ONLY

Notes: Termination availability

- (1) J & Y terminations only.
 - (2) J, Y, A & H terminations available.
 - (3) J, Y, A & H terminations available on values ≤5.6nF. Y & H terminations on values >5.6nF.
- PY2 Unmarked capacitors also available as released in accordance with approval specifications. Suffix Code SY2 applies.
 SP Unmarked capacitors also available as released in accordance with approval specifications. Suffix Code SPU applies.
 B16 Unmarked capacitors with a dual ac/dc rating are also available as released in accordance with approval specifications. Suffix Code U16 applies.
 B17 Unmarked capacitors with a dual ac/dc rating are also available as released in accordance with approval specifications. Suffix Code U17 applies.



250Vac Safety Certified AC Capacitors



Ordering information - Safety Certified capacitors - Class SPU/SP ranges

1808	J	A25	0102	J	C	T	SP
Chip size	Termination	Voltage	Capacitance in picofarads (pF)	Capacitance tolerance	Dielectric codes	Packaging	Suffix code
1808 2211 2215	<p>*J = Nickel barrier (100% matte tin plating). RoHS compliant. Lead free.</p> <p>Y = FlexiCap™ termination base with nickel barrier (100% matte tin plating). RoHS compliant.</p> <p>2211/2215 only</p> <p>*A = Nickel barrier (Tin/lead plating with min. 10% lead). Not RoHS compliant.</p> <p>H = FlexiCap™ termination base with nickel barrier (Tin/lead plating with minimum 10% lead). Not RoHS compliant.</p>	A25 = 250Vac	<p>First digit is 0. Second and third digits are significant figures of capacitance code.</p> <p>The fourth digit is number of zeros following.</p> <p>Example: 0102 = 1nF</p>	<p><10pF B = ±0.10pF C = ±0.25pF D = ±0.50pF ≥ 10pF F = ±1% G = ±2% J = ±5% K = ±10% M = ±20%</p> <p>Note: X7R (2R1) parts are available in J, K & M tolerances only.</p>	<p>A = COG/NP0 (1B) to AEC-Q200 E = X7R (2R1) to AEC-Q200</p> <p>C = COG/NP0 (1B) X = X7R (2R1)</p>	<p>T = 178mm (7") reel R = 330mm (13") reel B = Bulk pack - tubs or trays</p>	<p>SP = Surge Protection capacitors (marked and approved)</p> <p>SPU = Surge Protection capacitors (un-marked parts are in accordance with but not certified)</p>

Note: * J and A terminations are not available for dielectric code E.

Ordering information - Safety Certified capacitors - Class PY2/SY2

1808	J	A25	0102	J	X	T	PY2
Chip size	Termination	Voltage	Capacitance in picofarads (pF)	Capacitance tolerance	Dielectric codes	Packaging	Suffix code
1808 1812	<p>*J = Nickel barrier (100% matte tin plating). RoHS compliant. Lead free.</p> <p>Y = FlexiCap™ termination base with nickel barrier (100% matte tin plating). RoHS compliant.</p>	A25 = 250Vac	<p>First digit is 0. Second and third digits are significant figures of capacitance code.</p> <p>The fourth digit is number of zeros following.</p> <p>Example: 0102 = 1nF</p>	<p><10pF B = ±0.10pF C = ±0.25pF D = ±0.50pF ≥ 10pF F = ±1% G = ±2% J = ±5% K = ±10% M = ±20%</p> <p>Note: X7R (2R1) parts are available in J, K & M tolerances only.</p>	<p>A = COG/NP0 (1B) to AEC-Q200 E = X7R (2R1) to AEC-Q200</p> <p>C = COG/NP0 (1B) X = X7R (2R1)</p>	<p>T = 178mm (7") reel R = 330mm (13") reel B = Bulk pack - tubs or trays</p>	<p>PY2 = Safety tested Surge Protection capacitors (marked and approved)</p> <p>SY2 = Surge Protection capacitors (un-marked parts are in accordance with but not certified)</p>

Note: * J termination is not available for dielectric code E.

Ordering information - Safety Certified capacitors - Class B16/B17 ranges

2220	J	A25	0102	J	X	T	B16
Chip size	Termination	Voltage	Capacitance in picofarads (pF)	Capacitance tolerance	Dielectric codes	Packaging	Suffix code
2220	<p>*J = Nickel barrier (100% matte tin plating). RoHS compliant. Lead free.</p> <p>Y = FlexiCap™ termination base with nickel barrier (100% matte tin plating). RoHS compliant.</p> <p>*A = Nickel barrier (Tin/lead plating with min. 10% lead). Not RoHS compliant.</p> <p>H = FlexiCap™ termination base with nickel barrier (Tin/lead plating with minimum 10% lead). Not RoHS compliant.</p>	A25 = 250Vac	<p>First digit is 0. Second and third digits are significant figures of capacitance code.</p> <p>The fourth digit is number of zeros following.</p> <p>Example: 0102 = 1nF</p>	<p>J = ±5% K = ±10% M = ±20%</p>	<p>E = X7R (2R1) to AEC-Q200 - original S = X7R (2R1) to AEC-Q200 - recommended</p> <p>X = X7R (2R1)</p>	<p>T = 178mm (7") reel 1000 pieces R = 330mm (13") reel 4000 pieces B = Bulk pack - tubs or trays</p>	<p>B16 = Type A: X¹/Y² B17 = Type B: X²</p> <p>U16 = Surge protection Unmarked Type A X1/Y2 capacitors (with a dual ac/dc rating are 'in accordance with' but not certified)</p> <p>U17 = Surge protection Unmarked Type B X2 capacitors (with a dual ac/dc rating are 'in accordance with' but not certified)</p>

Note: * J and A terminations are not available for:
 Dielectric codes E and S (all capacitance values).
 Dielectric code X with suffix codes B16/U16 for capacitance values >5.6nF.

Open Mode Capacitors - COG/NP0 (1B) & X7R (2R1)



Open Mode capacitors have been designed specifically for use in applications where mechanical cracking is a severe problem and short circuits due to cracking are unacceptable.

Open Mode capacitors use inset electrode margins, which prevent any mechanical cracks which may form during board assembly from connecting to the internal electrodes.

When combined with FlexiCap™ termination, Open Mode capacitors provide a robust component with the assurance that if a part becomes cracked, the crack will be unlikely to result in short circuit failure.

Qualification included cracking the components by severe bend tests. Following the bend tests cracked components were subjected to endurance / humidity tests, with no failures evident due to short circuits. Note: Depending on the severity of the crack, capacitance loss was between 0% and 70%.



Note: = AEC-Q200.

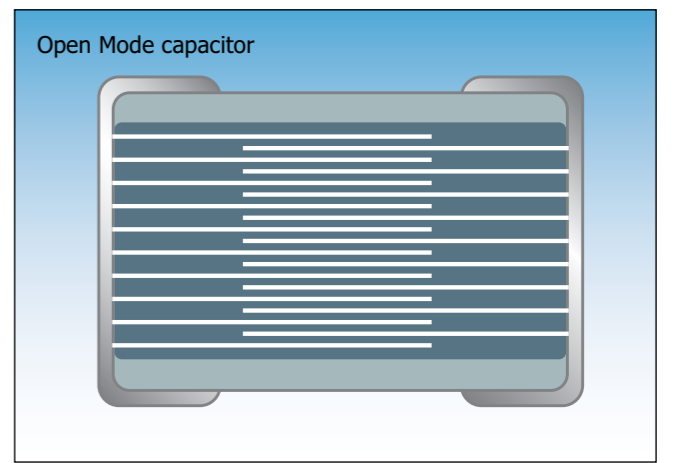

Open Mode - COG/NP0 (1B) - capacitance values

COG/NP0 (1B)	0603	0805	1206	1210	1808	1812	2220	2225
Max. Thickness	0.8mm	1.37mm	1.7mm	2.0mm	2.0mm	2.5mm	2.5mm	2.5mm
Min cap	10pF	10pF	10pF	22pF	22pF	47pF	68pF	100pF
16/25V	82pF	82pF	82pF	82pF	82pF	120pF	180pF	270pF
50/63V	82pF	82pF	82pF	82pF	82pF	120pF	180pF	270pF
100V	82pF	82pF	82pF	82pF	82pF	120pF	180pF	270pF
200/250V	82pF	82pF	82pF	82pF	82pF	120pF	180pF	270pF
500V	-	82pF	82pF	82pF	82pF	120pF	180pF	270pF
630V	-	47pF	82pF	82pF	82pF	120pF	180pF	270pF
1kV	-	47pF	82pF	82pF	82pF	120pF	180pF	270pF

Open Mode - X7R (2R1) - capacitance values

X7R (2R1)	0603	0805	1206	1210	1808	1812	2220	2225
Max. Thickness	0.8mm	1.37mm	1.7mm	2.0mm	2.0mm	2.5mm	2.5mm	2.5mm
Min cap	100pF	100pF	100pF	100pF	100pF	150pF	220pF	330pF
16V	39nF	100nF	150nF	220nF	470nF	470nF	680nF	1.5µF
25V	33nF	100nF	120nF	220nF	330nF	470nF	560nF	1.2µF
50/63V	22nF	100nF	220nF	470nF	470nF	1µF	1.5µF	2.7µF
100V	6.8nF	27nF	100nF	220nF	220nF	680nF	1µF	1.5µF
200/250V	2.7nF	22nF	68nF	100nF	100nF	330nF	680nF	1µF
500V	-	5.6nF	39nF	68nF	68nF	180nF	330nF	390nF
630V	-	-	22nF	33nF	27nF	100nF	180nF	220nF
1kV	-	-	6.8nF	15nF	15nF	47nF	100nF	100nF

Ordering information - Open Mode Capacitors

1206	Y	050	0224	K	X	T	---
Chip size	Termination	Voltage	Capacitance in picofarads (pF)	Capacitance tolerance	Dielectric codes	Packaging	Suffix code
0603 0805 1206 1210 1808 1812 2220 2225	<p>Y = FlexiCap™ termination base with nickel barrier (100% matte tin plating). RoHS compliant.</p>	<p>016 = 16V 025 = 25V 050 = 50V 063 = 63V 100 = 100V 200 = 200V 250 = 250V 500 = 500V 630 = 630V 1K0 = 1kV</p>	<p>First digit is 0. Second and third digits are significant figures of capacitance code. The fourth digit is number of zeros following.</p> <p>Example: 0224 = 220000pF</p>	<p>F = ±1% G = ±2% J = ±5% K = ±10% M = ±20%</p>	<p>A = COG/NP0 (1B) to AEC-Q200 - original K = COG/NP0 (1B) to AEC-Q200 - recommended E = X7R (2R1) to AEC-Q200 - original S = X7R (2R1) to AEC-Q200 - recommended C = COG/NP0 (1B) X = X7R (2R1)</p>	<p>T = 178mm (7") reel R = 330mm (13") reel B = Bulk pack - tubs or trays</p>	<p>M01 = Open Mode capacitor</p>

Note: X7R (2R1) parts are available in J, K & M tolerances only.

Tandem Capacitors - X7R (2R1)



Tandem Capacitors have been designed as a fail safe range using a series section internal design, for use in any application where short circuits would be unacceptable.

When combined with FlexiCap™ termination, Tandem capacitors provide an ultra robust and reliable component, for use in the most demanding applications.

Non-standard voltages are available. For more information please consult the Sales Office.

Qualification included cracking the components by severe bend tests. Following the bend tests cracked components were subjected to endurance / humidity tests, with no failures evident due to short circuits.
Note: Depending on the severity of the crack, capacitance loss was between 0% and 50%.

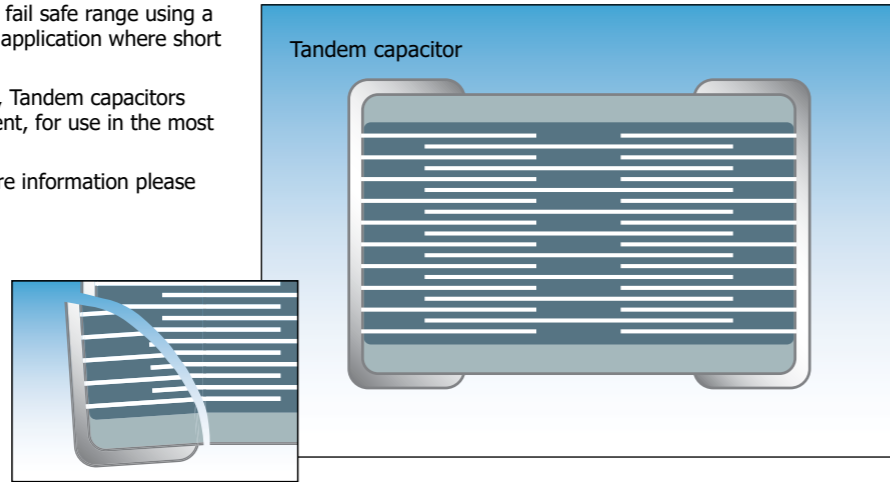

Tandem - X7R (2R1) - capacitance values

X7R (2R1)	0603	0805	1206	1210	1812	2220	2225
Max. Thickness	0.8mm	1.39mm	1.7mm	2.0mm	2.0mm	2.5mm	2.5mm
Min cap	100pF	100pF	100pF	100pF	150pF	220pF	330pF
16V	12nF	47nF	150nF	270nF	560nF	1.2µF	1.5µF
25V	10nF	39nF	120nF	220nF	470nF	1µF	1.2µF
50/63V	6.8nF	33nF	100nF	180nF	390nF	680nF	1µF
100V	2.2nF	10nF	47nF	82nF	220nF	470nF	680nF
200/250V	1nF	4.7nF	22nF	47nF	100nF	220nF	330nF

Note: ■ = AEC-Q200.

Ordering information - Tandem Capacitors

1206	Y	050	0224	K	X	T	---
Chip size	Termination	Voltage	Capacitance in picofarads (pF)	Capacitance tolerance	Dielectric codes	Packaging	Suffix code
0603 0805 1206 1210 1812 2220 2225	Y = FlexiCap™ termination base with nickel barrier (100% matte tin plating). RoHS compliant.	050 = 50V 063 = 63V 100 = 100V 200 = 200V 250 = 250V	First digit is 0. Second and third digits are significant figures of capacitance code. The fourth digit is number of zeros following. Example: 0224 = 220000pF	J = ±5% K = ±10% M = ±20%	E = X7R (2R1) to AEC-Q200 - original S = X7R (2R1) to AEC-Q200 - recommended X = X7R (2R1)	T = 178mm (7") reel R = 330mm (13") reel B = Bulk pack - tubs or trays	T01 = Tandem capacitor

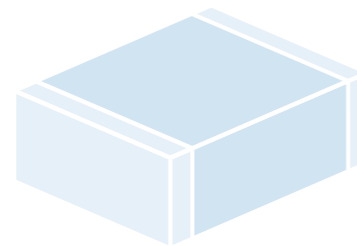
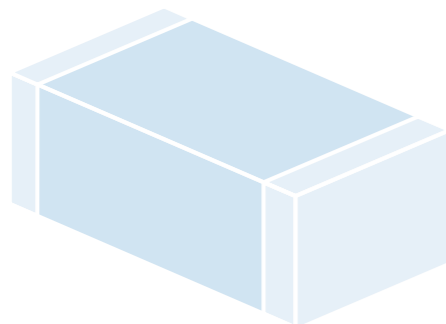

X8R High Temperature Caps - up to 150°C



The X8R dielectric will operate from -55°C to +150°C, with a maximum capacitance change ±15% (without applied voltage).

The devices are available in sizes 0805 to 2225, with voltage ranges from 25V to 3kV and capacitance values from 100pF to 2.2µF.

The capacitors have been developed by Knowles Precision Devices to meet demand from various applications in the automotive and industrial markets and in other electronic equipment exposed to high temperatures. The increased use of electronics in automotive "under the hood" applications has created demand for this product range.

The X8R range incorporates a specially formulated termination with a nickel barrier finish that has been designed to enhance the mechanical performance of these SMD chip capacitors in harsh environments typically present in automotive applications.



Capacitance Range

100pF to 2.2µF (0805 to 2225)

Temperature Coefficient of Capacitance (TCC)

±15% from -55°C to +150°C

Dissipation Factor (DF)

≤ 0.025

Termination

Nickel Barrier Tin Plated

Insulation Resistance (IR)

100G Ω or 1000secs (whichever is the less).

Dielectric Withstand Voltage (DWV)

2.5 x rated voltage for 5±1 seconds,
50mA charging current maximum.

Ageing Rate

1% per decade (typical)

X8R High Temperature Capacitors - capacitance values

X8R	0805	1206	1210	1808	1812	2220	2225
Max. Thickness	1.37mm	1.7mm	2.0mm	2.0mm	2.5mm	2.5mm	2.5mm
Min cap	100pF	100pF	100pF	100pF	150pF	220pF	330pF
50V	47nF	150nF	330nF	330nF	680nF	1.2µF	2.2µF
100V	33nF	100nF	220nF	220nF	470nF	1µF	1.5µF
200/250V	15nF	68nF	150nF	150nF	330nF	680nF	1µF
500V	4.7nF	22nF	47nF	47nF	120nF	330nF	470nF
630V	2.2nF	10nF	33nF	33nF	68nF	180nF	220nF
1kV	1.5nF	3.3nF	6.8nF	6.8nF	27nF	68nF	82nF
1.2kV	-	2.2nF	5.6nF	5.6nF	15nF	47nF	56nF
1.5kV	-	1.5nF	3.3nF	3.3nF	10nF	27nF	33nF
2kV	-	680pF	1.5nF	1.5nF	5.6nF	15nF	22nF
2.5kV	-	-	-	1.2nF	3.3nF	10nF	12nF
3kV	-	-	-	820pF	2.7nF	5.6nF	6.8nF

Note: ■ = AEC-Q200.

Ordering information - X8R High Temperature Capacitors

1206	Y	100	0473	K	N	T
Chip size	Termination	Voltage d.c.	Capacitance in picofarads (pF)	Capacitance tolerance	Dielectric codes	Packaging
0805 1206 1210 1808 1812 2220 2225	Y = FlexiCap™ termination base with nickel barrier (100% matte tin plating).	050 = 50V 100 = 100V 200 = 200V 250 = 250V 500 = 500V 630 = 630V 1K0 = 1kV 1K2 = 1.2kV 1K5 = 1.5kV 2K0 = 2kV 2K5 = 2.5kV 3K0 = 3kV	First digit is 0. Second and third digits are significant figures of capacitance code. The fourth digit is number of zeros following. Example: 0473 = 47000pF = 47nF	J = ±5% K = ±10% M = ±20%	N = X8R T = X8R AEC-Q200	T = 178mm (7") reel R = 330mm (13") reel B = Bulk pack - tubs or trays

Ultra-low ESR HiQ MLCCs - X8G range



The Ultra-low ESR HiQ X8G range offers a very stable, High Q material system that provides excellent low loss performance. Optimised for lowest possible ESR, the electrode system provides low metal losses resulting in flatter performance curves and reduced losses at higher frequencies. An extended operating temperature range of -55°C to +150°C accommodates modern high density micro electronics requirements. This range of high frequency capacitors is suitable for many applications where economical, high performance is required.



- Operating Temperature**
-55°C to +150°C (EIA X8G)
- Temperature Coefficient (Typical)**
0 ± 30 ppm/°C (EIA X8G)
- Insulation resistance**
Time constant (Ri xCr) (whichever is the least)
100GΩ or 1000s
- Q Factor**
>2000 @ 1MHz

Ultra-low ESR HiQ capacitors - X8G range - capacitance values

Chip Size	0402	0505	0603	0805	1111
Max. thickness	0.6mm	1.27mm	0.8mm	1.0mm	2.2mm
Min cap	0.2pF	0.5pF	0.2pF	0.2pF	0.5pF
Min cap	0.3pF	0.5pF	0.3pF	0.3pF	0.5pF
50V	100pF	1nF	470pF	1.5nF	5.1nF
100V	100pF	-	150pF	820pF	1.0nF
250V	30pF	33pF	150pF	430pF	820pF
500V	33pF	-	150pF	240pF	430pF
1kV	-	-	-	-	1.3nF
Tape quantities	7" reel - 10,000	7" reel - 2,500	7" reel - 4,000	7" reel - 3,000	7" reel - 1,000
	13" reel - 15,000	13" reel - 10,000	13" reel - 16,000	13" reel - 12,000	13" reel - 5,000

Notes: = AEC-Q200.
Below 1pF capacitance values are available in 0.1pF steps. Above 1pF capacitance values are available in E24 series values.

Ordering information - Ultra-low ESR HiQ capacitors - X8G range

0805	J	250	0101	J	H	T
Chip size	Termination	Voltage	Capacitance in picofarads (pF)	Capacitance tolerance	Dielectric	Packaging
0402 0505 0603 0805 1111	J = Nickel barrier (100% matte tin plating). RoHS compliant. Lead free.	050 = 50V 100 = 100V 250 = 250V 500 = 500V 1K0 = 1kV	<1.0pF: Insert a P for the decimal point as the first character. eg. P300 = 0.3pF Values in 0.1pF steps >1.0pF & <10pF: Insert a P for the decimal point as the second character. eg. 8P20 = 8.2pF Values are E24 series >10pF: First digit is 0. Second and third digits are significant figures of capacitance code. Fourth digit is number of zeros. eg. 0101 = 100pF Values are E24 series	<4.7pF H = ±0.05pF B = ±0.1pF C = ±0.25pF D = ±0.5pF <10pF B = ±0.1pF C = ±0.25pF D = ±0.5pF >10pF F = ±1% G = ±2% J = ±5% K = ±10%	V = Ultra-low ESR High Frequency X8G to AEC-Q200 H = Ultra-low ESR High Frequency X8G	T = 178mm (7") reel R = 330mm (13") reel B = Bulk pack - tubs or trays

Ultra-low ESR HiQ MLCCs - X8G range



Typical performance - 0603 chip size

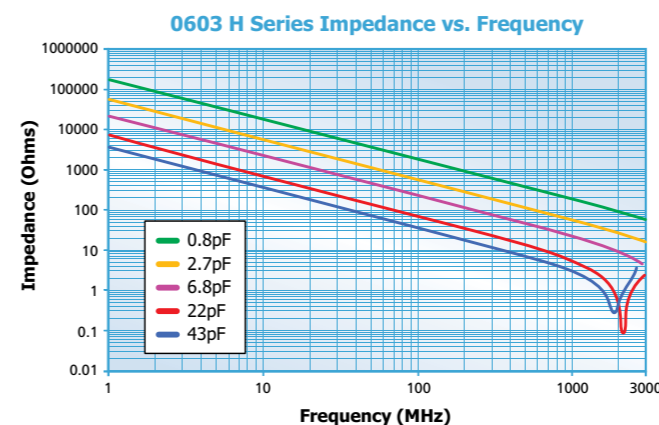

Typical performance - 0805 chip size

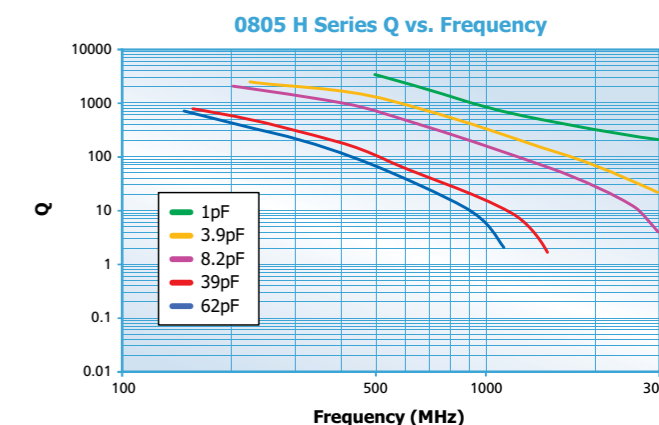
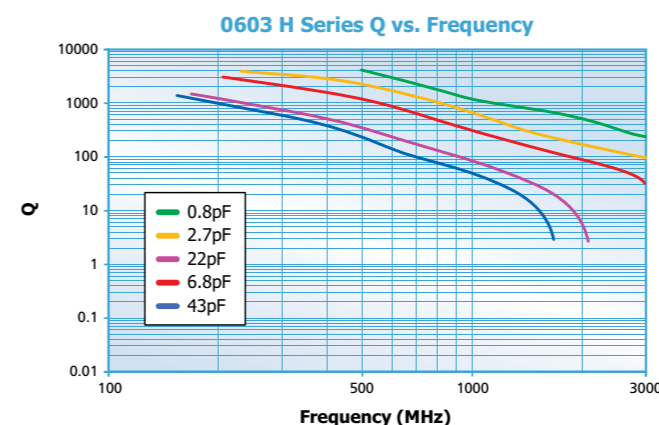
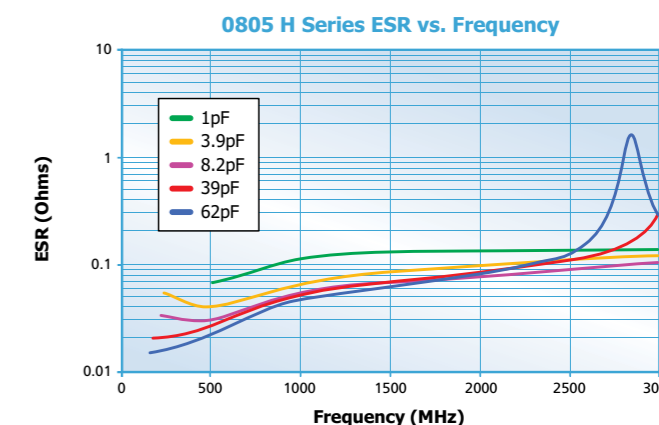
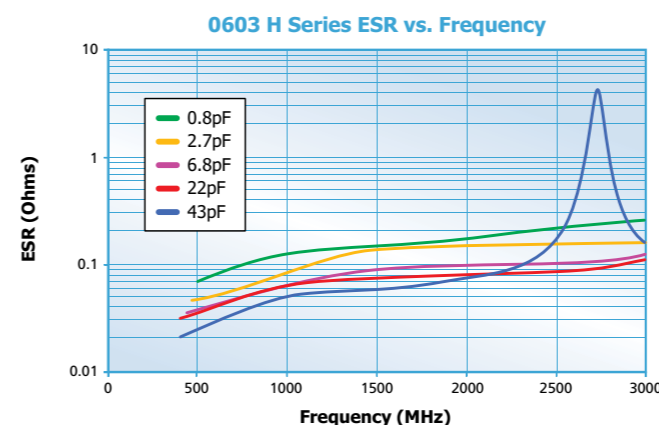
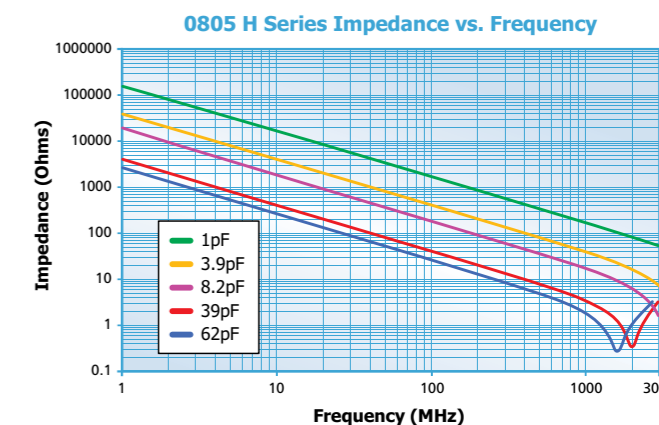

The E01 and E07 ranges of feedthrough MLCC chip 'C' filters are 3 terminal chip devices designed to offer reduced inductance compared to conventional MLCCs when used in signal line filtering.

The filtered signal passes through the chip internal electrodes and the noise is filtered to the grounded side contacts, resulting in reduced length noise transmission paths.

Available in COG/NP0 (1B) and X7R (2R1) dielectrics, with current ratings of 300mA, 1A, 2A, 3A and voltage ratings of 25Vdc to 200Vdc. Also available with FlexiCap™ termination which is strongly recommended for new designs.

Commonly used in automotive applications, a range qualified to AEC-Q200 is also available.



E01 300mA, E07 1A/2A/3A

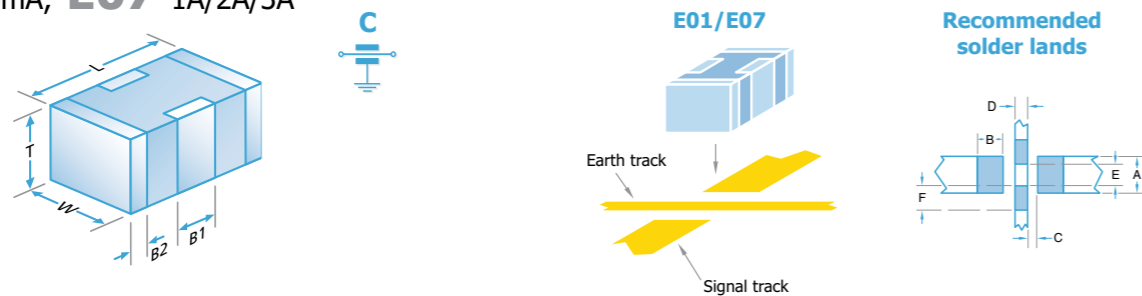

Dimensions

	0805	1206	1806	1812		0805	1206	1806	1812
L	2.0 ± 0.3 (0.079 ± 0.012)	3.2 ± 0.3 (0.126 ± 0.012)	4.5 ± 0.35 (0.177 ± 0.014)	4.5 ± 0.35 (0.177 ± 0.014)	A	0.95 (0.037)	1.20 (0.047)	1.2 (0.047)	2.65 (0.104)
W	1.25 ± 0.2 (0.049 ± 0.008)	1.6 ± 0.2 (0.063 ± 0.008)	1.6 ± 0.2 (0.063 ± 0.008)	3.2 ± 0.3 (0.126 ± 0.012)	B	0.90 (0.035)	0.90 (0.035)	1.40 (0.055)	1.40 (0.055)
T	1.0 ± 0.15 (0.039 ± 0.006)	1.1 ± 0.2 (0.043 ± 0.008)	1.1 ± 0.2 (0.043 ± 0.008)	2.0 ± 0.3 (0.079 ± 0.012)	C	0.30 (0.012)	0.60 (0.024)	0.80 (0.031)	0.80 (0.031)
B1	0.60 ± 0.2 (0.024 ± 0.008)	0.95 ± 0.3 (0.037 ± 0.012)	1.4 ± 0.3 (0.055 ± 0.012)	1.45 ± 0.35 (0.055 ± 0.012)	D	0.40 (0.016)	0.80 (0.031)	1.40 (0.055)	1.40 (0.055)
B2	0.3 ± 0.15 (0.012 ± 0.006)	0.5 ± 0.25 (0.02 ± 0.01)	0.5 ± 0.25 (0.02 ± 0.01)	0.75 ± 0.25 (0.02 ± 0.01)	E	0.75 (0.030)	1.0 (0.039)	1.0 (0.039)	2.05 (0.080)

- Notes: 1) All dimensions mm (inches).
 2) Pad widths less than chip width gives improved mechanical performance.
 3) The solder stencil should place 4 discrete solder pads. The unprinted distance between ground pads is shown as dim E.
 4) Insulating the earth track underneath the filters is acceptable and can help avoid displacement of filter during soldering but can result in residue entrapment under the chip.

Standard Range - E01 & E07 Feedthrough Capacitors

Type	E01			E07			
Chip Size	0805	1206	1806	0805	1206	1806	1812
Max Current	300mA	300mA	300mA	1A	2A	2A	3A
Rated Voltage	Dielectric						
Minimum and maximum capacitance values							
25Vdc	COG/NP0 (1B)	180pF - 1.5nF	560pF - 3.9nF	820pF - 4.7nF	180pF - 1.5nF	560pF-3.9nF	820pF-4.7nF
	X7R (2R1)	470pF - 100nF	5.6nF - 330nF	3.9nF - 560nF	820pF - 100nF	10nF - 330nF	22nF - 560nF
50Vdc	COG/NP0 (1B)	22pF - 820pF	22pF - 3.3nF	22pF - 3.9nF	10pF - 220pF	22pF - 1nF	100pF - 1.5nF
	X7R (2R1)	560pF - 68nF	4.7nF - 220nF	3.3nF - 330nF	1nF - 68nF	10nF - 220nF	22nF - 330nF
100Vdc	COG/NP0 (1B)	22pF - 560pF	22pF - 2.2nF	22pF - 3.3nF	10pF - 120pF	22pF - 560pF	100pF - 680pF
	X7R (2R1)	560pF - 27nF	1.8nF - 100nF	3.3nF - 180nF	1nF - 27nF	10nF - 100nF	22nF - 180nF
200Vdc	COG/NP0 (1B)	-	560pF - 1.2nF	56pF - 1nF	-	15pF - 180pF	56pF - 470pF
	X7R (2R1)	-	2.7nF - 56nF	3.9nF - 100nF	-	12nF - 56nF	22nF - 100nF

Note: E07 25Vdc COG/NP0 (1B) 1206 and 1806 ranges in green, have maximum current of 1A.

AEC-Q200 Qualified Range - E01 & E07 Feedthrough Capacitors - capacitance values

Type	E01			E07		
Chip Size	0805	1206	1806	0805	1206	1806
50V	COG/NP0 (1B)	22pF - 820pF	22pF - 1nF	22pF - 2.2nF	10pF - 220pF	22pF - 1nF
	X7R (2R1)	560pF - 47nF	4.7nF - 100nF	3.3nF - 200nF	1nF - 47nF	10nF - 100nF
100V	COG/NP0 (1B)	22pF - 560pF	22pF - 1nF	22pF - 2.2nF	10pF - 120pF	22pF - 560pF
	X7R (2R1)	560pF - 15nF	1.8nF - 15nF	3.3nF - 68nF	1nF - 15nF	10nF - 15nF

Notes: ■ = AEC-Q200. For some lower capacitance parts, higher voltage rated parts may be supplied.

Open board insertion loss performance in 50Ω system

Capacitance	Open Board Performance					Resonance Freq (MHz) approx.
	0.1MHz	1MHz	10MHz	100MHz	1GHz	
10pF	0	0	0	0	7.5	2200
22pF	0	0	0	0	16	1600
33pF	0	0	0	1	22	1350
47pF	0	0	0	2	28	1150
68pF	0	0	0	3	41	900
100pF	0	0	0	5	28	800
150pF	0	0	0	8	24	700
220pF	0	0	0	12	20	600
330pF	0	0	1	15	20	500
470pF	0	0	2	18	20	425
560pF	0	0	3	20	20	350
680pF	0	0	4	22	20	300
820pF	0	0	5	24	20	260
1nF	0	0	7	27	20	220
1.5nF	0	0	9	31	20	200
2.2nF	0	0	12	34	20	170
3.3nF	0	1	14	39	20	135
4.7nF	0	2	18	46	20	110
6.8nF	0	3	21	50	20	90
10nF	0	5	24	48	20	80
15nF	0	8	27	45	20	65
22nF	0	12	31	43	20	56
33nF	1	14	34	40	20	40
47nF	2	17	38	40	20	34
68nF	4	20	41	40	20	30
100nF	6	24	45	40	20	28
150nF	8	26	48	40	20	24
220nF	10	30	52	40	20	17
330nF	13	33	55	40	20	15.5
470nF	16	36	60	40	20	14
560nF	18	39	65	40	20	12

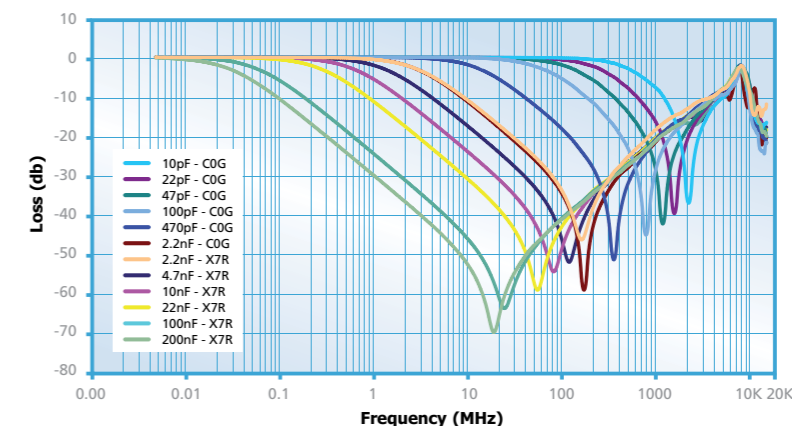

Ordering Information - E01 & E07 feedthrough capacitors

1206	Y	100	0103	M	X	T	E07
Chip size	Termination	Voltage	Capacitance in picofarads (pF)	Tolerance	Dielectric	Packaging	Type
0805 1206 1806 1812	J = Nickel Barrier (Tin) *Y = FlexiCap™ (Tin - X7R (2R1) only) *A = (Tin/Lead) Not RoHS compliant. *H = FlexiCap™ (Tin/Lead) Not RoHS compliant.	025 = 25V 050 = 50V 100 = 100V 200 = 200V	First digit is 0. Second and third digits are significant figures of capacitance code. The fourth digit is number of zeros following Example: 0103 = 10000pF.	M = ±20%	A = COG/NP0 (1B) to AEC-Q200 E = X7R (2R1) to AEC-Q200 C = COG/NP0 (1B) X = X7R (2R1)	T = 178mm (7") reel R = 330mm (13") reel B = Bulk	E01 E07

Notes: A, Y and H terminations are not available for dielectric codes A and C.
 J and A terminations are not available for dielectric code E.
 Please contact our Sales Office for any special requirements.

Reeled quantities	178mm (7") reel	0805	1206	1806	1812	330mm (13") reel	0805	1206	1806	1812
		3000	2500	2500	500		12000	10000	10000	2000



The X2Y Integrated Passive Component is a 3 terminal EMI chip device.

When used in balanced line applications, the revolutionary design provides simultaneous line-to-line and line-to-ground filtering, using a single ceramic chip. In this way, differential and common mode filtering are provided in one device.

For unbalanced applications, it provides ultra low ESL (equivalent series inductance). Capable of replacing 2 or more conventional devices, it is ideal for balanced and unbalanced lines, twisted pairs and dc motors, in automotive, audio, sensor and other applications.

Available in sizes from 0805 to 1812, these filters can prove invaluable in meeting stringent EMC demands.

Manufactured by Knowles Capacitors under licence from X2Y Attenuators LLC.



Dielectric
X7R (2R1) or COG/NPO (1B)
Electrical configuration
Multiple capacitance

Capacitance measurement
At 1000hr point
Typical capacitance matching
Better than 5%
(down to 1% available on request)

Temperature rating
-55°C to 125°C
Insulation resistance
100Gohms or 1000s (whichever is the less)

Dielectric withstand voltage
≤200V 2.5 times rated Volts for 5 secs
500V 1.5 times rated Volts for 5 secs
Charging current limited to 50mA Max.

Type		E03			
Chip size		0805	1206	1410	1812
Rated voltage	Dielectric				
25Vdc	COG/NPO (1B)	560pF - 820pF	1.8nF - 3.3nF	6.8nF - 8.2nF	12nF - 15nF
	X7R (2R1)	56nF - 68nF	-	470nF - 470nF	820nF - 820nF
50Vdc	COG/NPO (1B)	390pF - 470pF	1.2nF - 1.5nF	4.7nF - 5.6nF	8.2nF - 10nF
	X7R (2R1)	18nF - 47nF	56nF - 220nF	180nF - 400nF	390nF - 680nF
100Vdc	COG/NPO (1B)	10pF - 330pF	22pF - 1nF	100pF - 3.9nF	820pF - 6.8nF
	X7R (2R1)	470pF - 15nF	1.5nF - 47nF	4.7nF - 150nF	8.2nF - 330nF
200Vdc	COG/NPO (1B)	-	22pF - 1nF	100pF - 3.3nF	820pF - 5.6nF
	X7R (2R1)	-	820pF - 33nF	1.2nF - 120nF	2.7nF - 180nF
500Vdc	COG/NPO (1B)	-	-	-	820pF - 3.9nF
	X7R (2R1)	-	-	-	2.7nF - 100nF

Note: For some lower capacitance parts, higher voltage rated parts may be supplied.

AEC-Q200 range (E03) - capacitance values

Chip size		0805	1206	1410	1812
50Vdc	COG/NPO (1B)	390pF - 470pF	1.2nF - 1.5nF	4.7nF - 5.6nF	8.2nF - 10nF
	X7R (2R1)	18nF - 33nF	56nF - 150nF	180nF - 330nF	390nF - 560nF
100Vdc	COG/NPO (1B)	10pF - 330pF	22pF - 1nF	100pF - 3.9nF	820pF - 6.8nF
	X7R (2R1)	470pF - 15nF	1.5nF - 47nF	4.7nF - 150nF	8.2nF - 330nF

Note: = AEC-Q200.

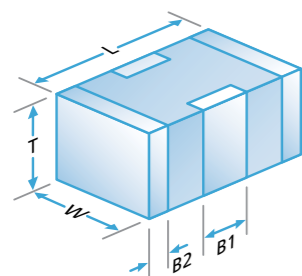

	0805	1206	1410	1812
L	2.0±0.3 (0.08±0.012)	3.2±0.3 (0.126±0.012)	3.6±0.3 (0.14±0.012)	4.5±0.35 (0.18±0.014)
W	1.25±0.2 (0.05±0.008)	1.60±0.2 (0.063±0.008)	2.5±0.3 (0.1±0.012)	3.2±0.3 (0.126±0.012)
T	1.0±0.15 (0.04±0.006)	1.1±0.2 (0.043±0.008)	2.0 max. (0.08 max.)	2.1 max. (0.08 max.)
B1	0.5±0.25 (0.02±0.01)	0.95±0.3 (0.037±0.012)	1.20±0.3 (0.047±0.012)	1.4±0.35 (0.06±0.014)
B2	0.3±0.15 (0.012±0.006)	0.5±0.25 (0.02±0.01)	0.5±0.25 (0.02±0.01)	0.75±0.25 (0.03±0.01)

- Notes:
- All dimensions mm (inches).
 - Pad widths less than chip width gives improved mechanical performance.
 - The solder stencil should place 4 discrete solder pads. The un-printed distance between ground pads is shown as dim E.
 - Insulating the earth track underneath the filters is acceptable and can help avoid displacement of filter during soldering but can result in residue entrapment under the chip.

Recommended solder lands

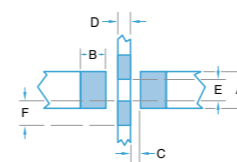

	0805	1206	1410	1812
A	0.95 (0.037)	1.2 (0.047)	2.05 (0.08)	2.65 (0.104)
B	0.9 (0.035)	0.9 (0.035)	1.0 (0.040)	1.4 (0.055)
C	0.3 (0.012)	0.6 (0.024)	0.7 (0.028)	0.8 (0.031)
D	0.4 (0.016)	0.8 (0.031)	0.9 (0.035)	1.4 (0.055)
E	0.75 (0.030)	1.0 (0.039)	1.85 (0.071)	2.05 (0.080)

Component	Advantages	Disadvantages	Applications
Chip capacitor	Industry standard	Requires 1 per line High inductance Capacitance matching problems	By-pass Low frequency
3 terminal feedthrough	Feedthrough Lower inductance	Current limited	Feedthrough Unbalanced lines High frequency
Syfer X2Y Integrated Passive Component	Very low inductance Replaces 2 (or 3) components Negates the effects of temperature, voltage and ageing Provides both common mode and differential mode attenuation Can be used on balanced & unbalanced lines	Care must be taken to optimise circuit design	By-pass Balanced lines High frequency dc electric motors Unbalanced lines Audio amplifiers CANBUS

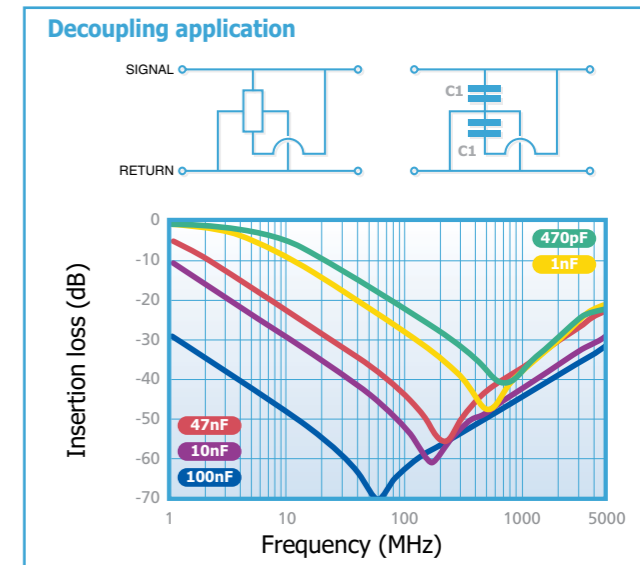
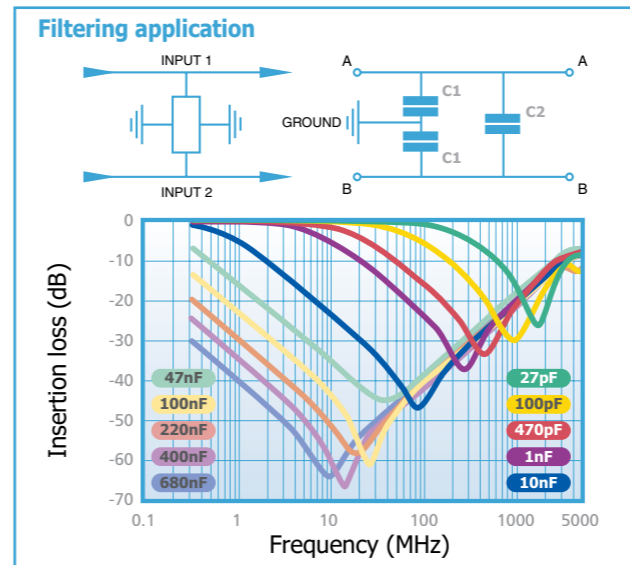

Ordering Information - X2Y IPC range

1812	Y	100	0334	M	X	T	E03
Chip Size	Termination	Voltage	Capacitance in picofarads (pF) C1	Tolerance	Dielectric	Packaging	Type
0805 1206 1410 1812	J = Nickel Barrier (Tin) *Y = FlexiCap™ (Tin - X7R (2R1) only) *A = (Tin/Lead) Not RoHS compliant. *H = FlexiCap™ (Tin/Lead) Not RoHS compliant.	025 = 25V 050 = 50V 100 = 100V 200 = 200V 500 = 500V	First digit is 0. Second and third digits are significant figures of capacitance code. The fourth digit is number of zeros following Example: 0334=330nF. Note: C ₁ = 2C ₂	M = ±20% (Tighter tolerances may be available on request).	A = COG/NPO (1B) to AEC-Q200 E = X7R (2R1) to AEC-Q200 C = COG/NPO (1B) X = X7R (2R1)	T = 178mm (7") reel R = 330mm (13") reel B = Bulk	X2Y Integrated Passive Component

Notes: A, Y and H terminations are not available for dielectric codes A and C.
J and A terminations are not available for dielectric code E.
Please contact our Sales Office for any special requirements.

Reeled quantities	178mm (7") reel	0805	1206	1410	1812	330mm (13") reel	0805	1206	1410	1812
		3000	2500	2000	500		12000	10000	8000	2000



Other products available from

that may interest you that are not **AEC-Q200** qualified.

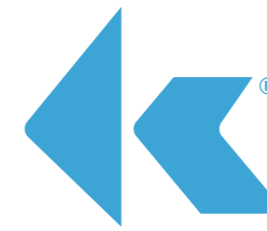

knowles
PRECISION DEVICES

VC1 Residual Capacitors - X7R (2R1)

The VC1 residual capacitance range MLCCs provide a more stable capacitance value with voltage - not to drop below 50% of the 1Vrms 1kHz value, up to full rated DC voltage, at room temperature.

They can be operated continuously at full rated voltage, but if derated will maintain a larger percentage of their original capacitance value, e.g. at 80% RV capacitance value equals 60% approx - see graph.

Defined capacitance value in case sizes from 0805 to 3640, with voltage rating up to 3kV. Ideal for Power supplies, capacitance critical circuits, smoothing circuits and EMI suppression.

Operating Temperature

-55°C to +125°C

Temperature Coefficient (Typical)

± 15%

Insulation Resistance at +25°C

Time constant (Ri xCr) (whichever is the least) 100GΩ or 1000s

Ageing Rate

Typical 1% per time decade

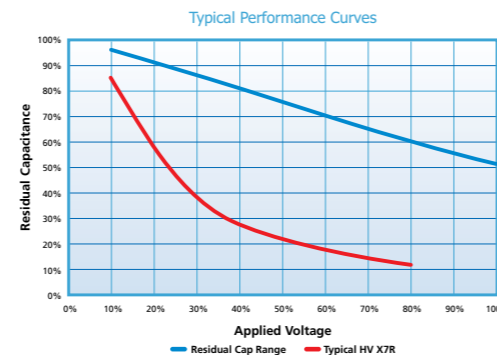

Minimum/maximum capacitance values - VC1 Capacitors

Chip Size	0805	1206	1210	1808	1812	2220	2225	3640
Min Cap	100pF	150pF	220pF	220pF	470pF	1nF	1nF	2.2nF
250V	12nF	39nF	82nF	82nF	220nF	680nF	1µF	1.8µF
500V	2.2nF	6.8nF	15nF	15nF	56nF	150nF	220nF	560nF
630V	1.5nF	4.7nF	8.2nF	8.2nF	39nF	100nF	120nF	470nF
1000V	390pF	1.5nF	2.7nF	2.7nF	15nF	39nF	56nF	180nF
1200V	-	1nF	2.2nF	2.2nF	10nF	27nF	39nF	120nF
1500V	-	560pF	1.2nF	1.2nF	5.6nF	15nF	22nF	68nF
2000V	-	270pF	560pF	560pF	3.3nF	10nF	12nF	39nF
2500V	-	-	-	-	1.8nF	5.6nF	8.2nF	22nF
3000V	-	-	-	-	-	3.9nF	5.6nF	12nF
7" reel qty	3,000	2,500	2,000	500	500	500	500	n/a
13" reel qty	12,000	10,000	8,000	2,000	2,000	2,000	2,000	500

Note: Other capacitance values may become available, please contact the Sales Office if you need values other than those shown in the above table. For dimensions and soldering information, please go to our website www.knowlescapacitors.com

High Temp. HiT range - 200°C - COG/NP0 (1B) & X7R (2R1)

The HiT range of multilayer ceramic capacitors is suitable for a variety of high temperature applications including: oil exploration, geothermal, military, automotive under-hood and avionics.

This range is manufactured to exacting standards using our unique screen printing process. This provides a high quality component suitable for demanding applications.

- 200°C operating temperature
- 0603 to 2220 chip sizes
- COG/NP0 (1B) and X7R dielectric options
- Capacitance range COG/NP0 (1B) from 4.7pF up to 47nF
- Capacitance range X7R (2R1) from 100pF up to 4.7µF
- Voltage ratings from 10V to 630V
- RoHS compliant / Pb Free
- Sn over Ni termination
- Sample kits available

Insulation Resistance (IR)

25°C >100GΩ or 1000secs (whichever is the less).
200°C >1GΩ or 10secs (whichever is the less).

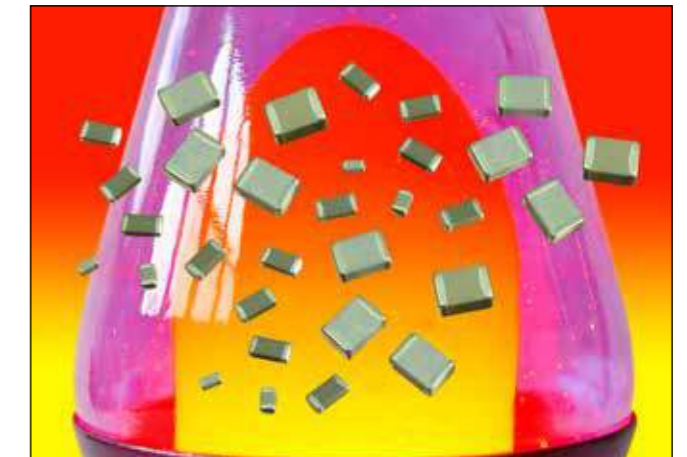

Temperature Coefficient of Capacitance (TCC)

COG/NP0 (1B) 30ppm/°C to +125°C.

X7R (2R1) ±15% to +125°C

Ageing Rate

COG/NP0 (1B) Zero.

X7R (2R1) typically less than 2% per time decade.

High Temp. HiT250 range - 250°C - COG/NP0 (1B) & X7R (2R1)

The HiT250 range of multilayer ceramic capacitors is suitable for a variety of high temperature applications including: oil exploration, geothermal, military, automotive under-hood and avionics.

This range is manufactured to exacting standards using our unique screen printing process. This provides a high quality component suitable for demanding applications.

- 250°C operating temperature
- 0603 to 2220 chip sizes
- COG/NP0 (1B) and X7R dielectric options
- Capacitance range COG/NP0 (1B) from 3.9pF up to 39nF
- Capacitance range X7R (2R1) from 1nF up to 2.2µF
- Voltage ratings from 10V to 630V
- RoHS compliant / Pb Free
- Sn over Ni termination
- Sample kits available



Insulation Resistance (IR)

25°C >100GΩ or 1000secs (whichever is the less).

250°C >100MΩ or 1secs (whichever is the less).

Temperature Coefficient of Capacitance (TCC)

COG/NP0 (1B) 30ppm/°C to +125°C

X7R (2R1) ±15% to +125°C

Ageing Rate

COG/NP0 (1B) Zero.

X7R (2R1) typically less than 2% per time decade.

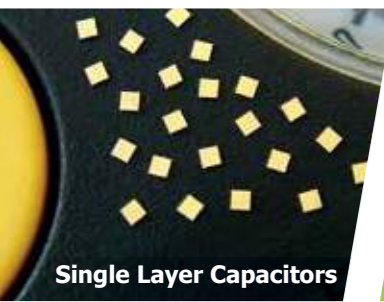

Single Layer Capacitors



Pulse Capacitors



StackiCap™ Capacitors



Hi-Rel Products

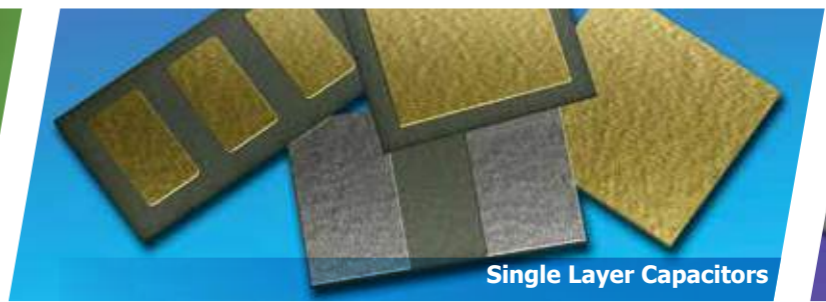

Single Layer Capacitors

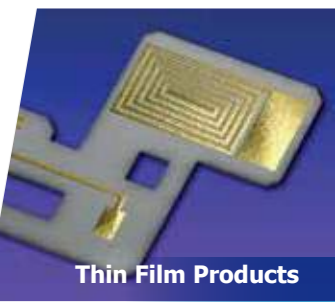

Thin Film Products



Power Dividers

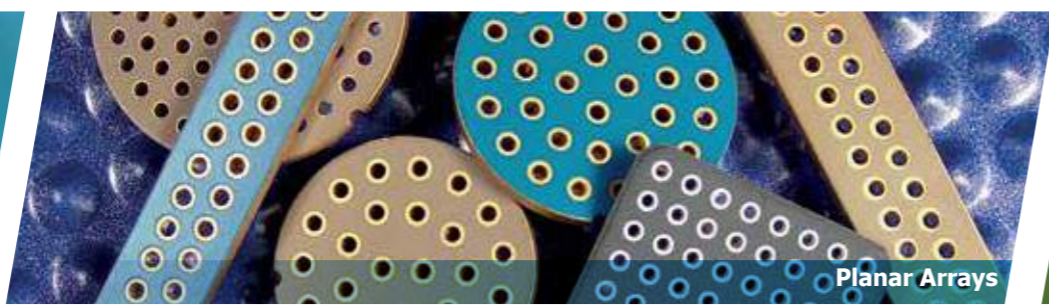

Planar Arrays



Ultra Low ESR Capacitors

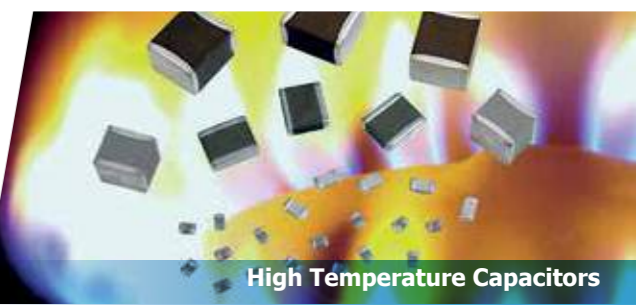

High Temperature Capacitors

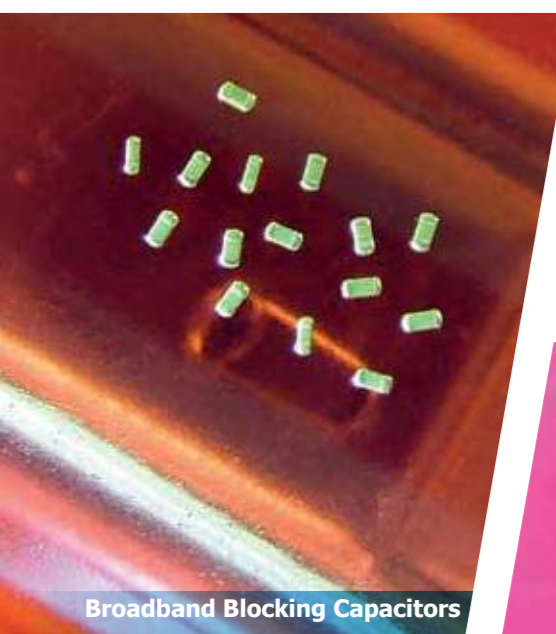

Broadband Blocking Capacitors



Feedthrough EMI Filters

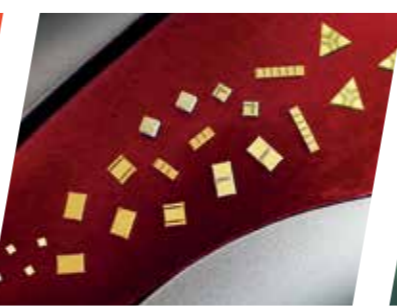

Opti-Cap Capacitors

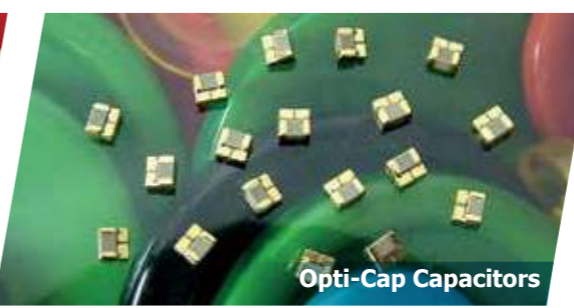

Safety Certified Capacitors



EMI Filters

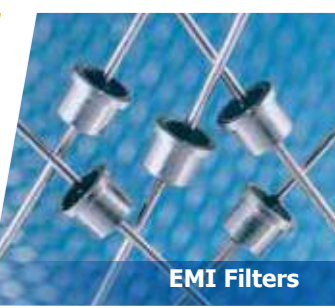

Gain Equalizers



Specialty Products



HIT Capacitors



X2Y 3 terminal EMI chips



Solder in EMI Filters

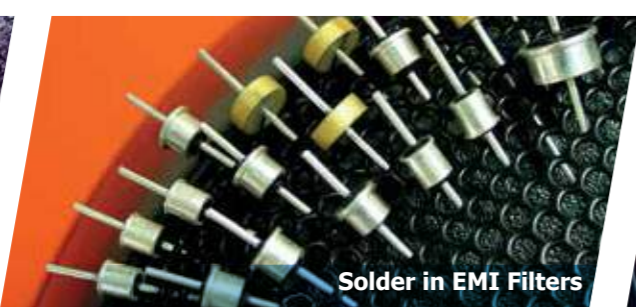

Pulse Power Capacitors



Radial Leaded Capacitors



High capacitance value chips

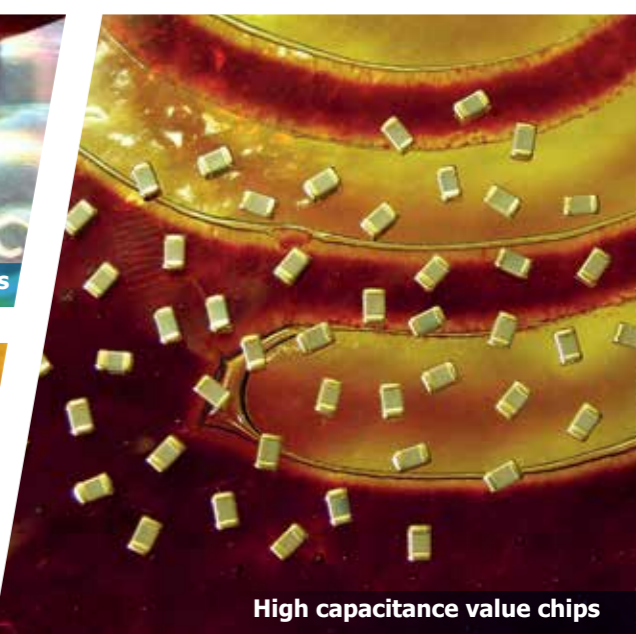

Other products available from





PRECISION DEVICES
knowles

**COMPEX • DLI • JOHANSON MFG
NOVACAP • SYFER • VOLTRONICS**

Asian Sales Office

O: +86 512 62588258

F: +86 512 62589258

KPD-Asia-sales@knowles.com

European Sales Office

O: +44 1603 723300

F: +44 1603 723301

KPD-Europe-sales@knowles.com

North American Sales Office

O: +1 661 295 5920

F: +1 661 295 5928

O: +1 315 655 8710

F: +1 315 655 0445

KPD-NA-sales@knowles.com

11069/Automotive/20/v2

X-ON Electronics

Largest Supplier of Electrical and Electronic Components

Click to view similar products for [Multilayer Ceramic Capacitors MLCC - SMD/SMT](#) category:

Click to view products by [Knowles](#) manufacturer:

Other Similar products are found below :

[M39014/02-1225V](#) [M39014/22-0631](#) [D55342E07B523DR-T/R](#) [NCA1206X7R103K50TRPF](#) [NCA1206X7R104K16TRPF](#) [NIN-FC2R7JTRF](#)
[NMC0402NPO220J50TRPF](#) [NMC0402X5R105K6.3TRPF](#) [NMC0402X5R224K6.3TRPF](#) [NMC0402X7R103J25TRPF](#)
[NMC0402X7R392K50TRPF](#) [NMC0603NPO201J50TRPF](#) [NMC0603X5R475M6.3TRPF](#) [NMC0603X7R333K16TRPF](#)
[NMC0805NPO820J50TRPF](#) [NMC0805X7R224K16TRPLPF](#) [NMC1206X7R102K50TRPF](#) [NMC1206X7R106K10TRPLPF](#)
[NMC1206X7R475K10TRPLPF](#) [C1608C0G2A221J](#) [C1608X7R1E334K](#) [C2012C0G2A472J](#) [2220J2K00562KXT](#) [CDR33BX104AKUR](#)
[CDR33BX683AKUS](#) [CGA3E1X7R1C684K](#) [CL10C0R8BB8ANNC](#) [C1005X5R0G225M](#) [C2012X7R2E223K](#) [C3216C0G2J272J](#)
[D55342E07B35E7R-T/R](#) [NMC0402NPO150G50TRPF](#) [NMC0402NPO560F50TRPF](#) [NMC0402X7R562J25TRPF](#)
[NMC0603NPO102J25TRPF](#) [NMC1206X7R332K50TRPF](#) [726632-1](#) [CGA6M3X7R1H225K](#) [CGA5L2X7R2A105K](#) [CGA3E2X8R1H223K](#)
[CDR33BX823AKUR\M500](#) [CDR35BX474AKUR\M500](#) [CDR35BX104BKUR\M500](#) [69995D](#) [NMC0201X5R473K6.3TRPF](#)
[NMC0201X7R221K25TRPF](#) [NMC0402X5R105K10TRPF](#) [NMC0402X5R224K10TRPF](#) [NMC0603X7R104J25TRPF](#)
[NMC0603X7R223K25TRPF](#)