

# Microwave Products Catalog

Knowles Precision Devices DLI brand microwave and mmWave products integrate two core competencies that have been honed for more than 40 years; ceramic expertise and thin film manufacturing. From a suite of catalog filters to custom build-to-print and design services, Knowles Precision Devices has a solution for even the most challenging applications.

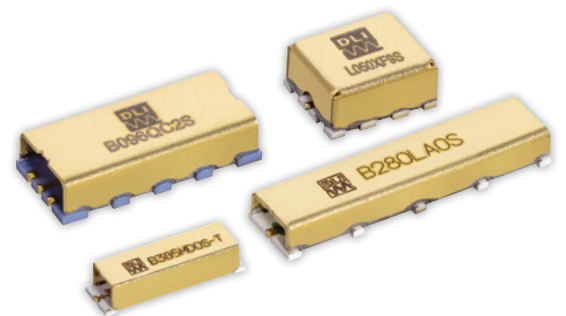
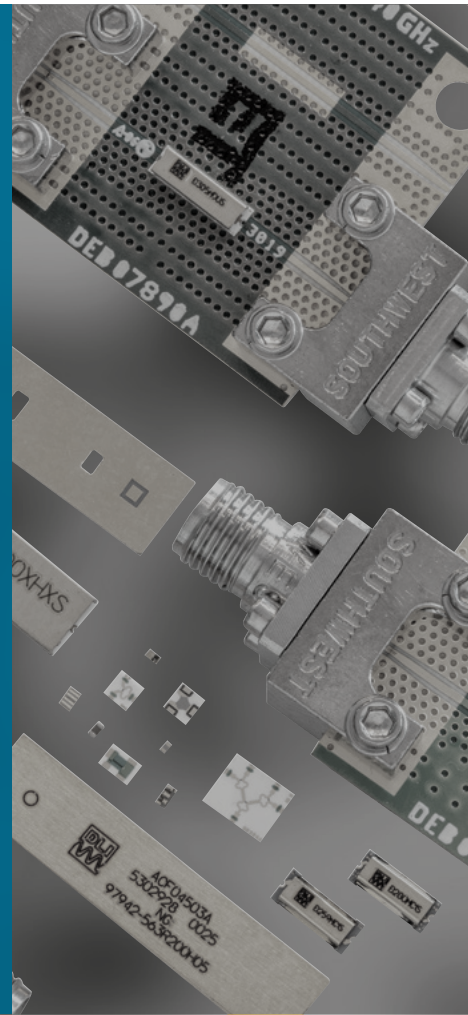

# Table of Contents

Who We Are .....	3
Mircowave Products .....	4
Mircostrip Filter Overview.....	6
Filter Catalog Part Number Structure.....	7
Bandpass Filter Ordering Information .....	8
Lowpass Filter Ordering Information .....	16
Highpass Filter Ordering Information .....	16
How to Specify a Filter.....	17
Cavity Filters .....	18
Resonators .....	19
Notch Filters .....	19
Custom and Build-to-Print.....	20
Integrated R-C Networks.....	22
Power Dividers.....	24
Couplers .....	26
Gain Equalizers .....	28
mmWave Filters.....	30
Speciality Kits .....	31
SatCom Offerings.....	32
User Guidelines: Chip and Wire or Hybrid Assembly.....	33
User Guidelines: Surface Mount .....	34
Recommend Reflow for Surface Mount.....	35

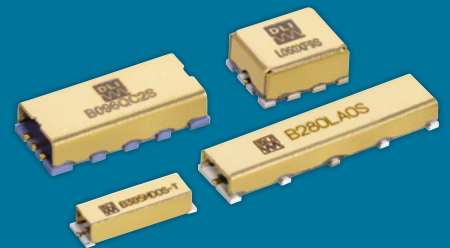

# Who We Are

**Knowles Precision Devices, a division of Knowles Corporation, focuses on production of a wide variety of highly engineered capacitors and microwave to mmWave components for use in critical applications in the military, medical, electric vehicle and 5G market segments.** The company was formed by combining Dielectric Laboratories, Johanson Manufacturing, Novacap, Syfer and Voltronics, each well-established specialty capacitor makers with a combined history of over 200 years, into a single organization.

As a specialty components manufacturer, Knowles Precision Devices chooses to take on the complex challenges that come with high-reliability, high-temperature, high-performance, and high-frequency solutions. The Knowles Precision Devices DLI brand of technologies addresses the complex challenges of implementing high-performance mmWave filters across the following range of specifications.

## DLI Microwave Product Evolution Timeline

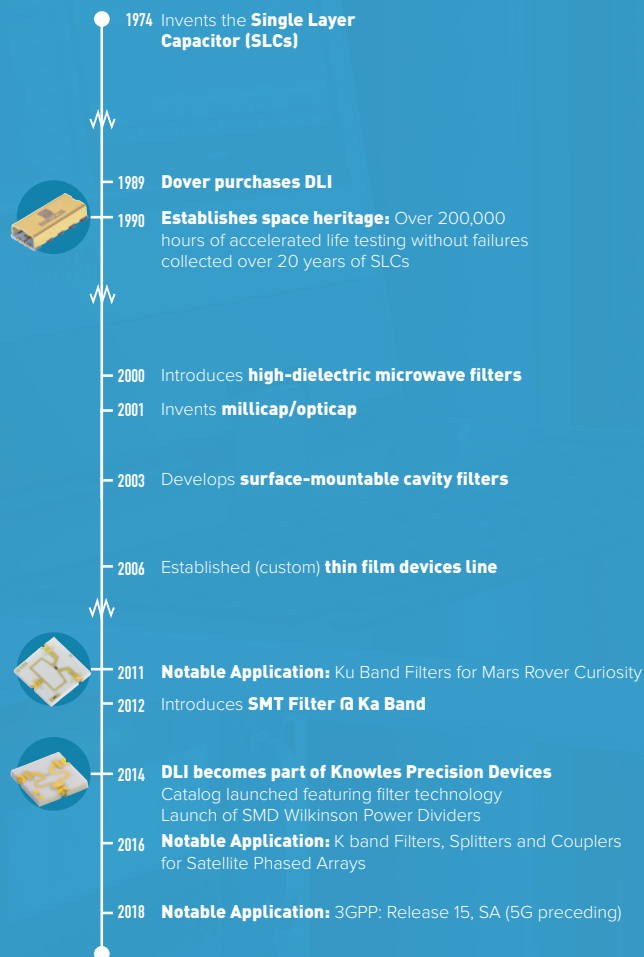

# Microwave Products

## FREQUENCY 800MHZ TO 60+ GHZ

### PRODUCT TYPES

Microstrip Filters  
Cavity Filters  
Bias Filters  
Notch Filters  
Resonators  
Gain Equalizers  
Power Dividers  
Couplers  
Integrated R-C Networks  
Self-Bias Networks  
CRC Decoupling Networks

### APPLICATIONS

Microwave Radar  
Test Equipment  
Switch Filter Banks  
Satellite Communications  
Telecom  
Radio Communications  
Synthesizers  
5G Infrastructure  
3GPP & mmWave

### KEY FEATURES AND BENEFITS OF ALL OUR MICROWAVE PRODUCTS



Small Size



Frequency Stable  
Over Temperature



Operating  
Temperature:  
-55°C to +125°C



Excellent  
Repeatability



Solder Surface  
Mount Package

# Microwave Products

## Why do DLI brand parts have exceptional performance?

The specialized attributes of our ceramic substrate materials:

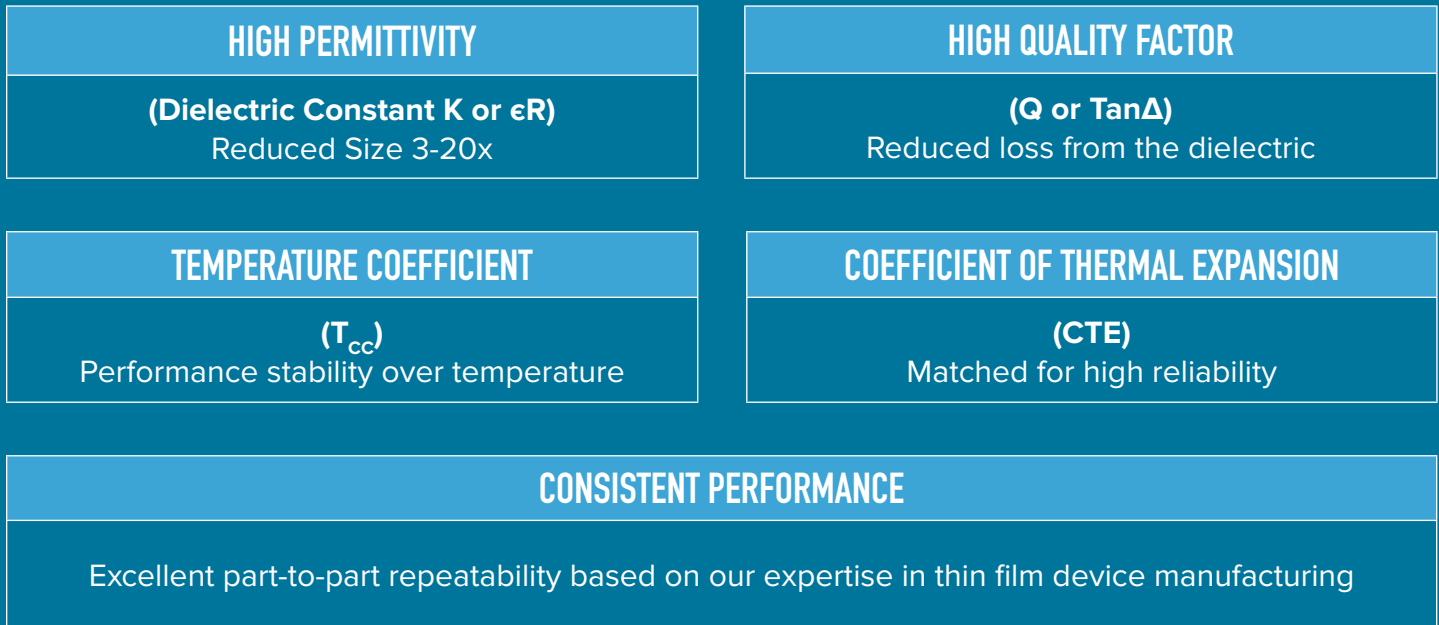

## CUSTOM IS STANDARD FOR US! CHOOSE YOUR PATH TO SUCCESS ...

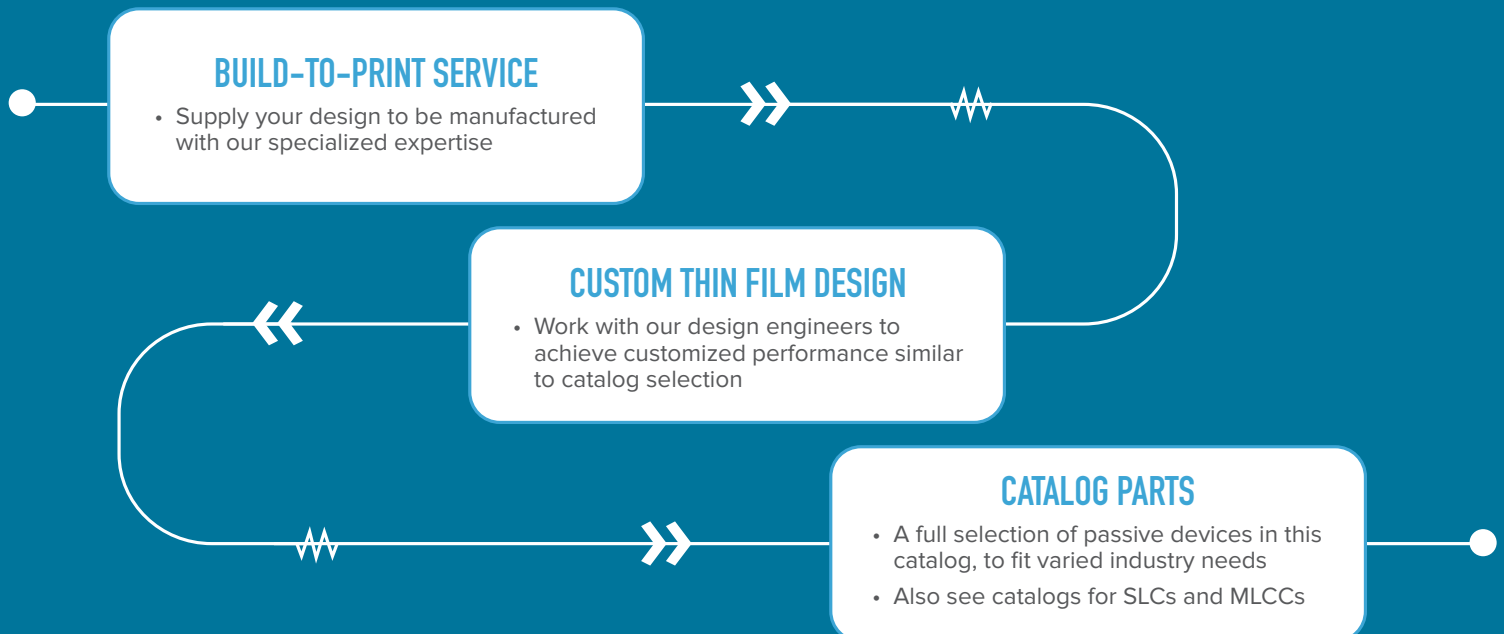

For more info on customizing a solution, see pages #20-21

# Microstrip Filter Overview

## BANDPASS

DLI bandpass filters are designed for high-performance microwave applications in a surface mountable package. Using temperature-stable, high-permittivity dielectrics and thin-film processing, these designs offer high selectivity without sacrificing in-band performance.

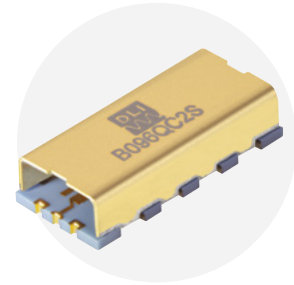
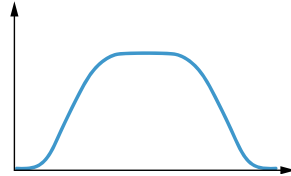

## LOWPASS

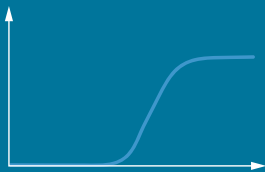

DLI's selection of lowpass and highpass filters aims to provide a drop-in solution for high-frequency attenuation. These filters have extreme repeatability, therefore multiple filters can be placed in series for increased rejection.

## HIGHPASS



### DESIGN ADVANTAGES:

- Miniaturization enabled by specialty high-Q ceramics
- Fully shielded component
- Surface mount device configuration available
- Consistent performance
- 100% testing before ship



### APPLICATIONS:

- 5G
- Aerospace
- Military
- Telecom
- Satellite communications



### KEY CHARACTERISTICS:

- Low variation over a wide temperature range
- Integrated RF shielding
- Characteristic impedance: 50Ω
- Moisture sensitivity level: MSL1
- No ESD sensitivity Ω

### ADDITIONAL FILTER TYPES:

<b>Cavity filters</b>	Page 18
<b>Notch filters</b>	Page 19
<b>Custom filters</b>	Page 20

### CERTIFICATION:



# Filter Catalog

## Part Number Structure

<b>L</b>	<b>0</b>	<b>6</b>	<b>0</b>	<b>X</b>	<b>D</b>	<b>9</b>	<b>S</b>
Filter type code	10GHz Place Value	1GHz Place Value	0.1 GHz Place Value	% BW Code	30 dB Rejection Level Code	Re-entrance Code	Package Code

FILTER TYPE CODE	
CODE	FILTER TYPE
B	BANDPASS
L	LOWPASS
H	HIGHPASS
C	CAVITY
N	NOTCH

PACKAGE CODE	
CODE	FILTER TYPE
W	WIRE-BOND
S	SMT

% BW CODE	
CODE	3DB% BW
J	0 - 1%
K	> 1 - 5%
L	> 5 - 10%
M	> 10 - 20%
N	> 30 - 40%
O	> 40 - 50%
P	> 50 - 60%
Q	> 50 - 60%
R	> 60%
X	LPF & HPF

30 DB REJECTION LEVEL CODE	
CODE	% OFF 3 DB CORNER
A	0 - 2%
B	> 2 - 4%
C	> 4 - 6%
D	> 6 - 8%
E	> 8 - 10%
F	> 10 - 15%
G	> 15 - 20%
H	> 20%

**Notes:**  
 LPF & HPF: Percentage off of 3db corner  
 BPF: Average percentage off 3dB BW  
 Notch: Average percentage 3dB BW to 10dB BW

RE-ENTRANCE CODE	
CODE	RE-ENTRANT MULTIPLIED
0	1.2 - 1.4
1	> 1.4 - 1.6
2	> 1.6 - 1.8
3	> 1.8 - 2.0
4	> 2.0 - 2.2
5	> 2.2 - 2.4
6	> 2.4 - 2.6
7	> 2.6 - 3.8
8	> 2.8 - 3.0
9	> 3.0
X	HPF

**Notes:**  
 Re-entrance is multiplier past the highside 30dB rejection level.  
 Notch: Multiplier from corner of first notch to center or second notch

# Bandpass Filter Ordering Information

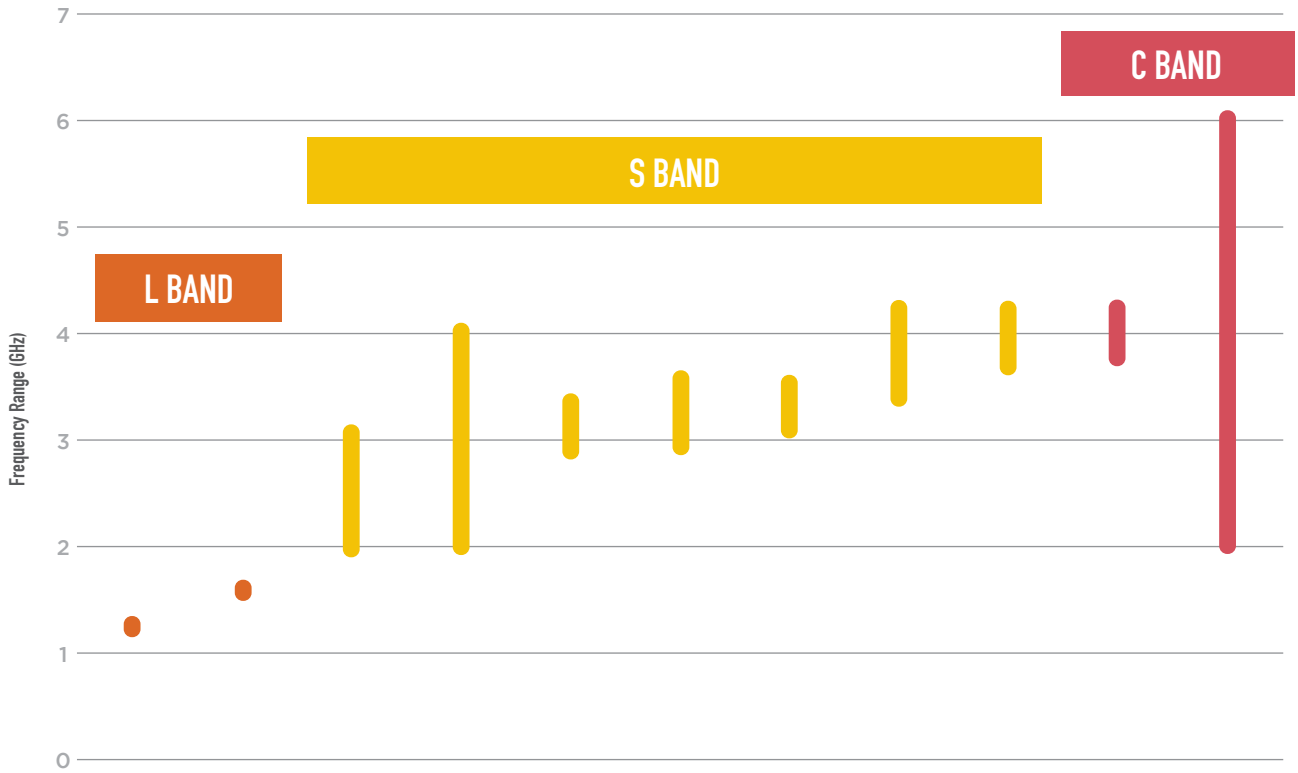

Part Number	B012MD5S	B016MD6S	B024RF2S	B028RF2S	B031ND5S	B032ND5S	B033ND5S	B038NC4S	B039NC5S	B040MB5S	B040RG9S
Center Frequency (GHz)	1.227	1.575	2.4	2.8	3.1	3.24	3.3	3.8	3.95	4	4
Bandwidth (GHz)	0.01	0.01	1.08	2	0.43	0.6	0.4	0.8	0.5	0.44	4
<b>Insertion Loss</b>											
@ 25°C (dB)	3.5	3.5	3	2	3	3	2	2.25	2.5	2.5	2.75
-40°C to +85°C (dB)	4.2	4.2	3.5	3	3.5	3.5	3.2	2.5	2.75	2.75	3.25
VSWR (Ω)	2.0:1	2.0:1	2.0:1	1.63:1	2.0:1	1.67:1	2.0:1	2.0:1	2.0:1	2.0:7	2.0:1
<b>Rejection</b>											
Amplitude (dB)	40	40	40	40	40	40	40	40	40	40	40
LS Range (GHz)	DC - 0.925	DC - 1.175	DC - 1.25	DC - 1.25	DC - 2.4	DC - 2.3	DC - 2.25	DC - 2.8	DC - 3.0	DC - 3.4	DC - 0.75
HS Range (GHz)	1.45 - 2.5	1.875 - 3.0	3.8 - 4.75	4.85 - 6.0	3.85 - 7.0	4.1 - 7.0	4.0 - 6.0	4.7 - 8.9	4.8 - 8.0	4.6 - 10.0	7.25 - 18.75
<b>Dimensions (inches)</b>											
Length	0.460	0.460	0.500	0.450	0.500	0.500	0.393	0.550	0.500	0.500	0.590
Width	0.460	0.460	0.250	0.400	0.250	0.250	0.353	0.220	0.250	0.250	0.280
Height	0.113	0.113	0.110	0.113	0.100	0.110	0.128	0.098	0.110	0.100	0.093
<b>Dimensions (mm)</b>											
Length	11.684	11.684	12.700	11.430	12.700	12.700	9.982	13.970	12.700	12.700	14.986
Width	11.684	11.684	6.350	10.160	6.350	6.350	8.966	5.588	6.350	6.350	7.112
Height	2.870	2.870	2.794	2.870	2.540	2.794	3.251	2.489	2.794	2.540	2.362





## Bandpass Filter Ordering Information

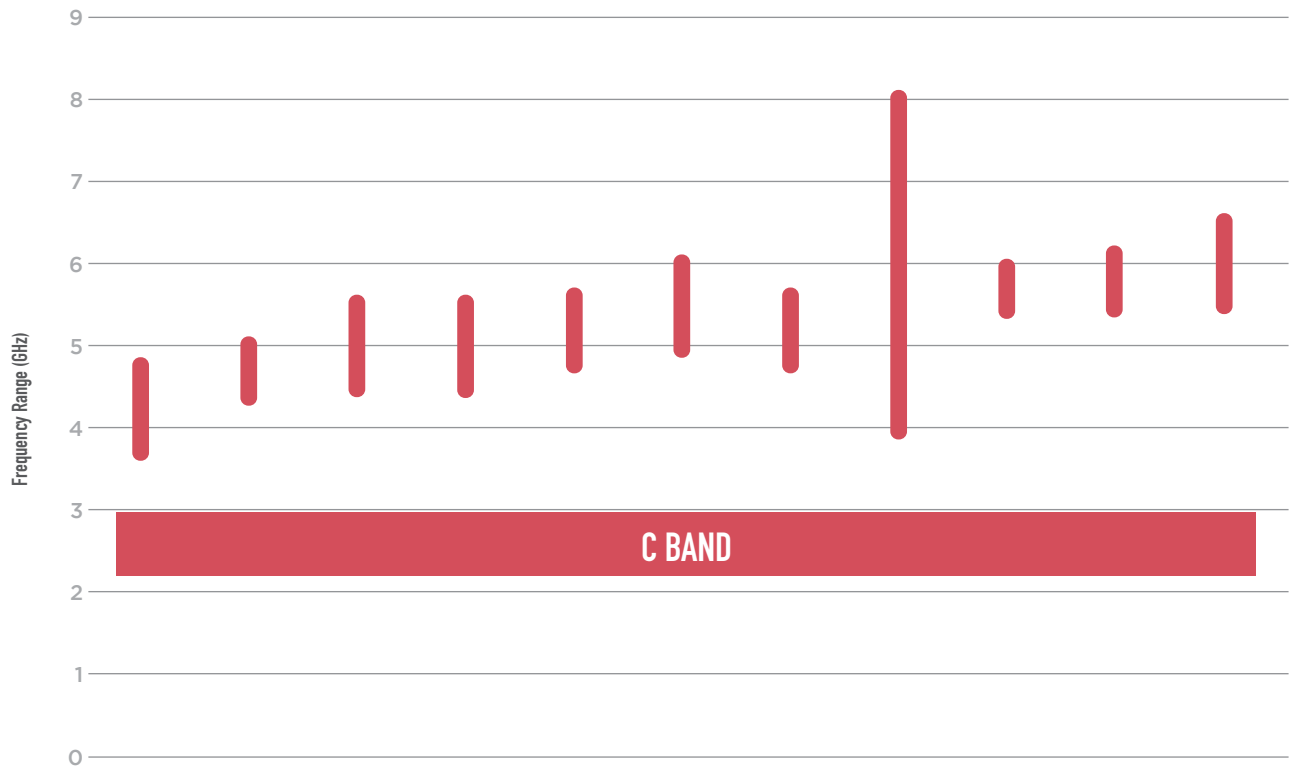

Part Number	B0420D4S	B047MC5S	B050NC4S	B050ND4S	B052NC5S	B055NC5S	B056MB5S	B056RC4S	B057MC5S	B058MD7S	B060NC5S
Center Frequency (GHz)	4.2	4.7	5	5	5.2	5.5	5.6	5.6	5.7	5.8	6
Bandwidth (GHz)	1	0.6	1	1	0.8	1	0.05	4	0.5	0.6	1
<b>Insertion Loss</b>											
@ 25°C (dB)	3	2	2	2	2.25	2	2	3	2	2.3	2
-40°C to +85°C (dB)	3.5	2.5	2.5	2.5	2.75	2.5	2.5	3.5	2.5	2.8	3
VSWR (Ω)	1.67:1	2.0:1	1.67:1	1.58:1	1.67:1	2.0:12	2.0:13	1.5:1	1.67:1	1.67:1	1.29:1
<b>Rejection</b>											
Amplitude (dB)	40	40	40	40	40	40	40	40	40	40	40
LS Range (GHz)	DC - 3.0	DC - 3.8	DC - 3.65	DC - 3.65	DC - 3.5	DC - 4.2	DC - 4.8	DC - 3.0	DC - 4.7	DC - 4.65	DC - 4.9
HS Range (GHz)	5.6 - 10.0	5.5 - 11.0	6.15 - 12.0	6.15 - 12.0	6.2 - 12.5	6.75 - 12.0	6.75 - 14.0	9.5 - 12.0	6.6 - 14.25	7.0 - 16.0	7.1 - 14.0
<b>Dimensions (inches)</b>											
Length	0.500	0.500	0.350	0.350	0.350	0.350	0.440	0.450	0.350	0.048	0.500
Width	0.250	0.250	0.200	0.200	0.200	0.200	0.240	0.230	0.200	0.275	0.200
Height	0.110	0.100	0.095	0.098	0.095	0.095	0.098	0.100	0.110	0.103	0.088
<b>Dimensions (mm)</b>											
Length	12.700	12.700	8.890	8.890	8.890	8.890	11.176	11.430	8.890	1.207	12.700
Width	6.350	6.350	5.080	5.080	5.080	5.080	6.096	5.842	5.080	6.985	5.080
Height	2.794	2.540	2.413	2.489	2.413	2.413	2.489	2.540	2.794	2.616	2.235



# Bandpass Filter Ordering Information

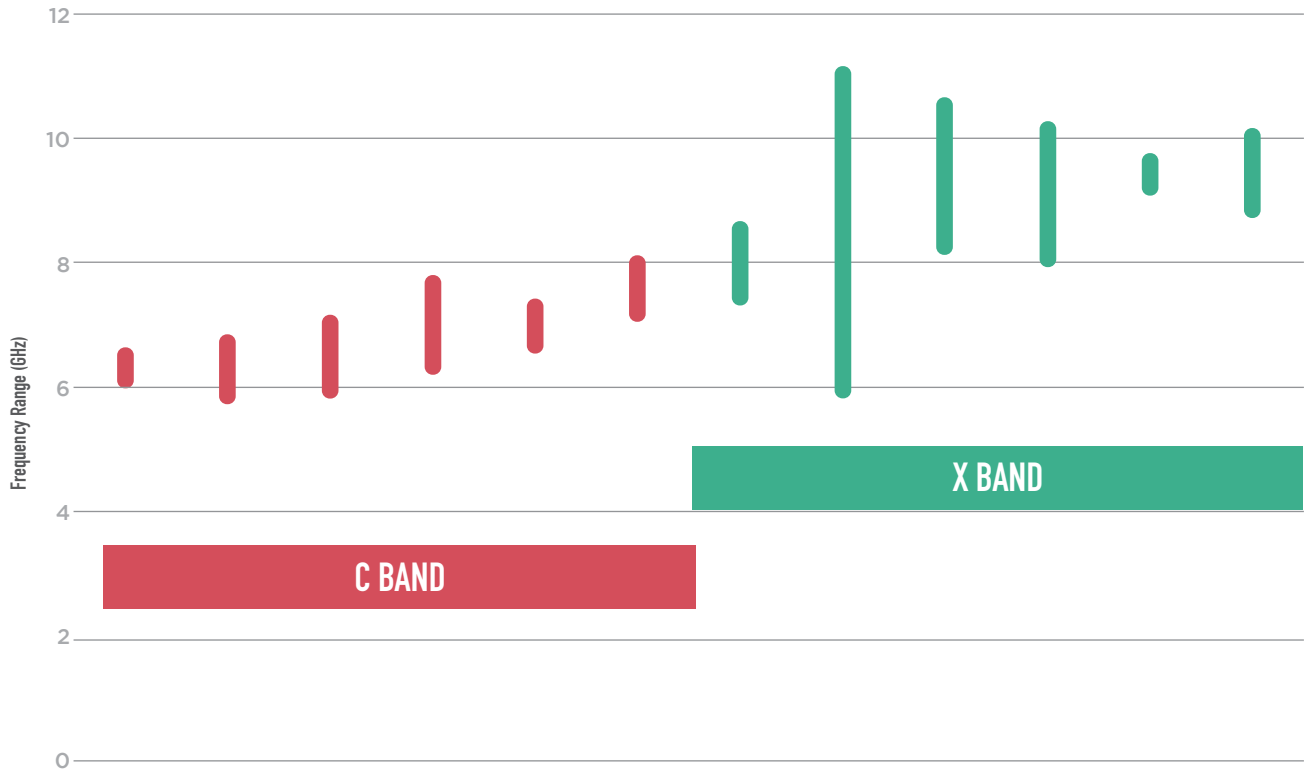

Part Number	B061MB6S	B062MC5S	B065NC5S	B070NC5S	B070MB6S	B076MB6S	B080MB5S	B081RC0S	B083LB6S	B089NC4S	B094LA2S	B095MB1S
Center Frequency (GHz)	6.1	6.3	6.5	7	7.1	7.6	8	8.1	8.3	8.9	9.4	9.5
Bandwidth (GHz)	0.5	0.8	1	1.26	0.55	0.72	1	5	0.5	2	0.35	1.1
<b>Insertion Loss</b>												
@ 25°C (dB)	3	2.5	3	2	2.5	2.5	2	3.4	2.5	2.5	2.75	1.75
-40°C to +85°C (dB)	3.5	2.75	3.5	2.5	2.75	2.75	3	3.9	2.75	2.75	3	2
VSWR (Ω)	2.0:1	1.67:1	1.67:1	2.0:1	2.0:1	2.2:1	1.29:1	2.0:1	1.92:1	1.92:1	1.58:1	1.92:1
<b>Rejection</b>												
Amplitude (dB)	40	40	40	40	40	40	40	40	40	40	40	40
LS Range (GHz)	DC - 5.25	DC - 5.2	DC - 5.2	DC - 5.8	DC - 6.2	DC - 6.69	DC - 6.8	DC - 3.5	DC - 8.825	DC - 6.8	DC - 8.6	DC - 8.0
HS Range (GHz)	7.25 - 16.0	7.5 - 15.0	7.75 - 15.0	8.5 - 17.5	7.8 - 15.0	8.52 - 18.25	9.25 - 17.0	14.0 - 19.0	11.35 - 16.5	11.25 - 20.0	10.25 - 15.0	11.5 - 20.0
<b>Dimensions (inches)</b>												
Length	0.450	0.500	0.500	0.500	0.500	0.500	0.500	0.190	0.450	0.400	0.450	0.400
Width	0.200	0.250	0.250	0.200	0.200	0.200	0.180	0.100	0.200	0.150	0.200	0.150
Height	0.098	0.095	0.095	0.100	0.100	0.100	0.100	0.090	0.103	0.103	0.098	0.103
<b>Dimensions (mm)</b>												
Length	11.430	12.700	12.700	12.700	12.700	12.700	12.700	4.826	11.430	10.160	11.430	10.160
Width	5.080	6.350	6.350	5.080	5.080	5.080	4.572	2.540	5.080	3.810	5.080	3.810
Height	2.489	2.413	2.413	2.540	2.540	2.540	2.540	2.286	2.616	2.616	2.489	2.616



## Bandpass Filter Ordering Information

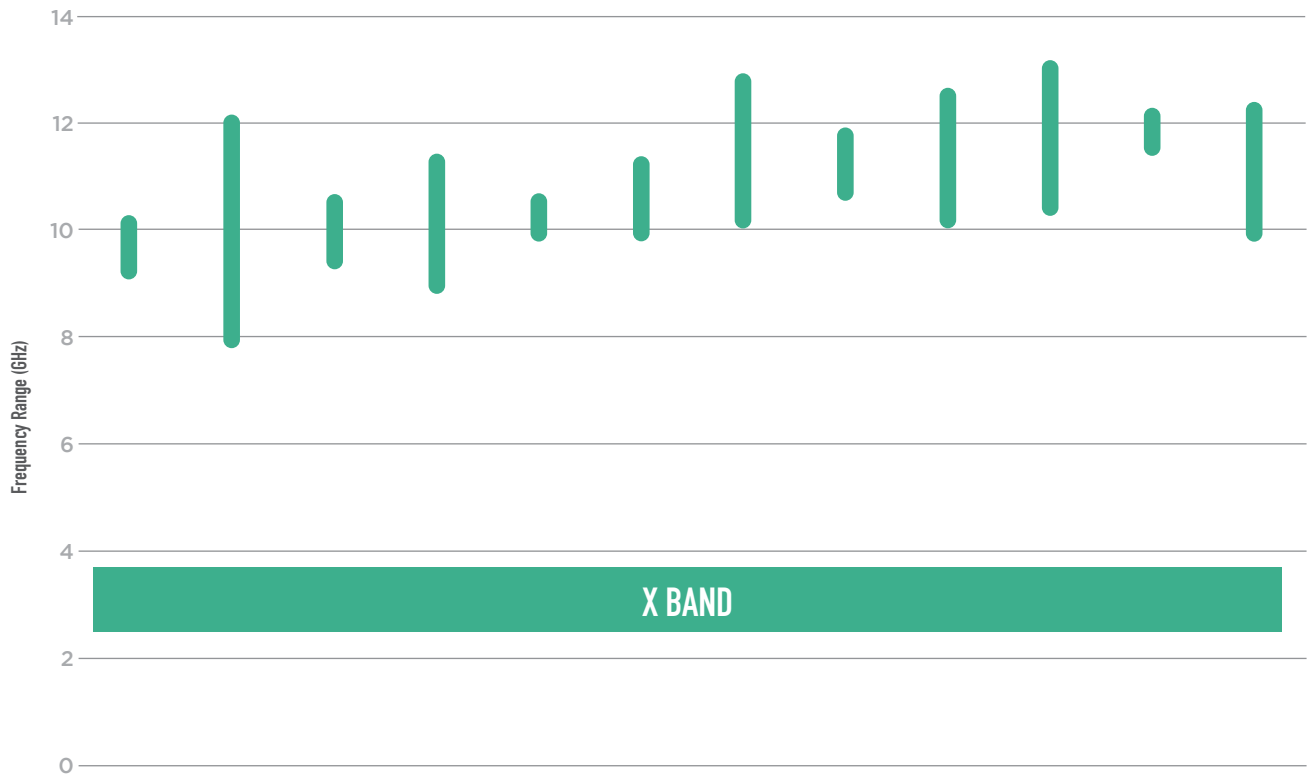

Part Number      B097MB0S   B096QC2S   B100MC5S   B099NC4S   B102MC1S   B105MB5S   B111NC4S   B112MB1S   B116NC5S   B115NB4S   B118LB4S   B119LB1S

Center Frequency (GHz)	9.7	10	10	10.25	10.25	10.6	11.2	11.2	11.4	11.6	11.8	11.9
Bandwidth (GHz)	0.8	4	1	2.25	0.5	1.2	2.5	1	2.25	2.5	0.5	2.2
<b>Insertion Loss</b>												
@ 25°C (dB)	2.5	2.5	2	2.25	2.25	1.75	2.25	2.25	2.25	2.5	2.5	3.25
-40°C to +85°C (dB)	2.75	3	2.5	2.25	2.25	2	2.25	2.75	2.5	2.75	2.75	3.75
VSWR (Ω)	1.92:1	2.0:1	1.92:1	1.58:1	1.92:1	1.92:1	1.92:1	1.92:1	1.92:1	1.92:1	1.58:1	2.0:1
<b>Rejection</b>												
Amplitude (dB)	40	40	40	40	40	40	40	40	40	40	40	40
LS Range (GHz)	DC - 8.1	DC - 6.0	DC - 8.5	DC - 7.5	DC - 9.0	DC - 8.0	DC - 8.75	DC - 9.4	DC - 9.0	DC - 9.5	DC - 10.25	DC - 10.75
HS Range (GHz)	11.35 - 23.0	14.0 - 18.0	11.75 - 20.0	13.0 - 23.0	11.35 - 16.5	13.0 - 23.5	14.5 - 25.0	13.25 - 20.0	14.25 - 23.5	14.5 - 23.0	13.25 - 18.0	13 - 19.5
<b>Dimensions (inches)</b>												
Length	0.400	0.400	0.400	0.400	0.450	0.450	0.400	0.400	0.400	0.575	0.450	0.450
Width	0.150	0.180	0.150	0.150	0.200	0.200	0.150	0.150	0.150	0.200	0.200	0.200
Height	0.103	0.100	0.098	0.090	0.090	0.103	0.090	0.103	0.090	0.093	0.103	0.098
<b>Dimensions (mm)</b>												
Length	10.160	10.160	10.160	10.160	11.430	11.430	10.160	10.160	10.160	14.605	11.430	11.430
Width	3.810	4.572	3.810	3.810	5.080	5.080	3.810	3.810	3.810	5.080	5.080	5.080
Height	2.616	2.540	2.489	2.286	2.286	2.616	2.286	2.616	2.286	2.362	2.616	2.489

## Bandpass Filter Ordering Information

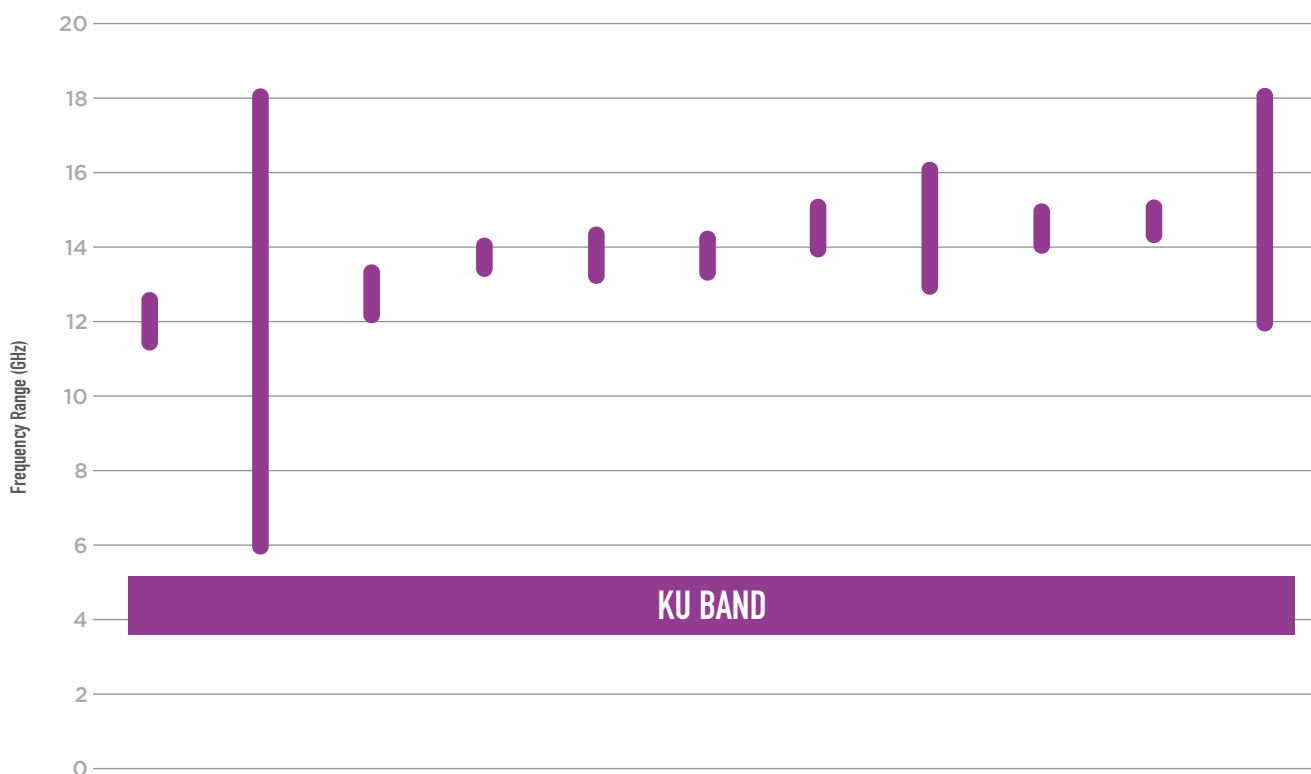

Part Number	B120MB1S	B120RF0S	B127MB2S	B138LA2S	B138MB1S	B142IA2S	B144MB1S	B1500G0S	B145LB1S	B148LA2S	B148QF0S
Center Frequency (GHz)	12	12	12.75	13.75	13.75	14.2	14.5	14.5	14.5	14.75	15
Bandwidth (GHz)	1	12	1	0.5	1	-0.6	1	3	0.8	0.5	6
<b>Insertion Loss</b>											
@ 25°C (dB)	2	2.5	2.75	2.75	2.75	4.5	2.4	2.25	3.5	3.25	3.6
-40°C to +85°C (dB)	3	3	3	3.25	3	5	2.5	2.5	3.75	3.5	4.2
VSWR (Ω)	1.29:1	2.0:1	1.58:1	1.58:1	1.58:1	2.0:1	1.58:1	1.58:1	2.0:1	1.58:1	1.63:1
<b>Rejection</b>											
Amplitude (dB)	40	40	40	40	40	40	40	40	40	40	40
LS Range (GHz)	DC - 10.6	DC - 3.3	DC - 10.75	DC - 12.5	DC - 11.75	DC - 13.25	DC - 12.25	DC - 10.5	DC - 12.5	DC - 13.25	DC - 7.6
HS Range (GHz)	13.2 - 19.5	19.8 - 22.0	14.25 - 19.75	14.75 - 22.00	15.25 - 21.00	15.25 - 25.0	16.25 - 22.0	18.0 - 25.0	16 - 22.25	16.0 - 20.0	23.0 - 25.0
<b>Dimensions (inches)</b>											
Length	0.525	0.450	0.400	0.450	0.400	0.575	0.400	0.375	0.550	0.450	0.550
Width	0.225	0.200	0.200	0.180	0.200	0.200	0.200	0.140	0.230	0.180	0.150
Height	0.090	0.103	0.098	0.098	0.098	0.093	0.098	0.093	0.093	0.098	0.098
<b>Dimensions (mm)</b>											
Length	13.335	11.430	10.160	11.430	10.160	14.605	10.160	9.525	13.970	11.430	13.970
Width	5.715	5.080	5.080	4.572	5.080	5.080	5.080	3.556	5.842	4.572	3.810
Height	2.286	2.616	2.489	2.489	2.489	2.362	2.489	2.362	2.362	2.489	2.489

## Bandpass Filter Ordering Information

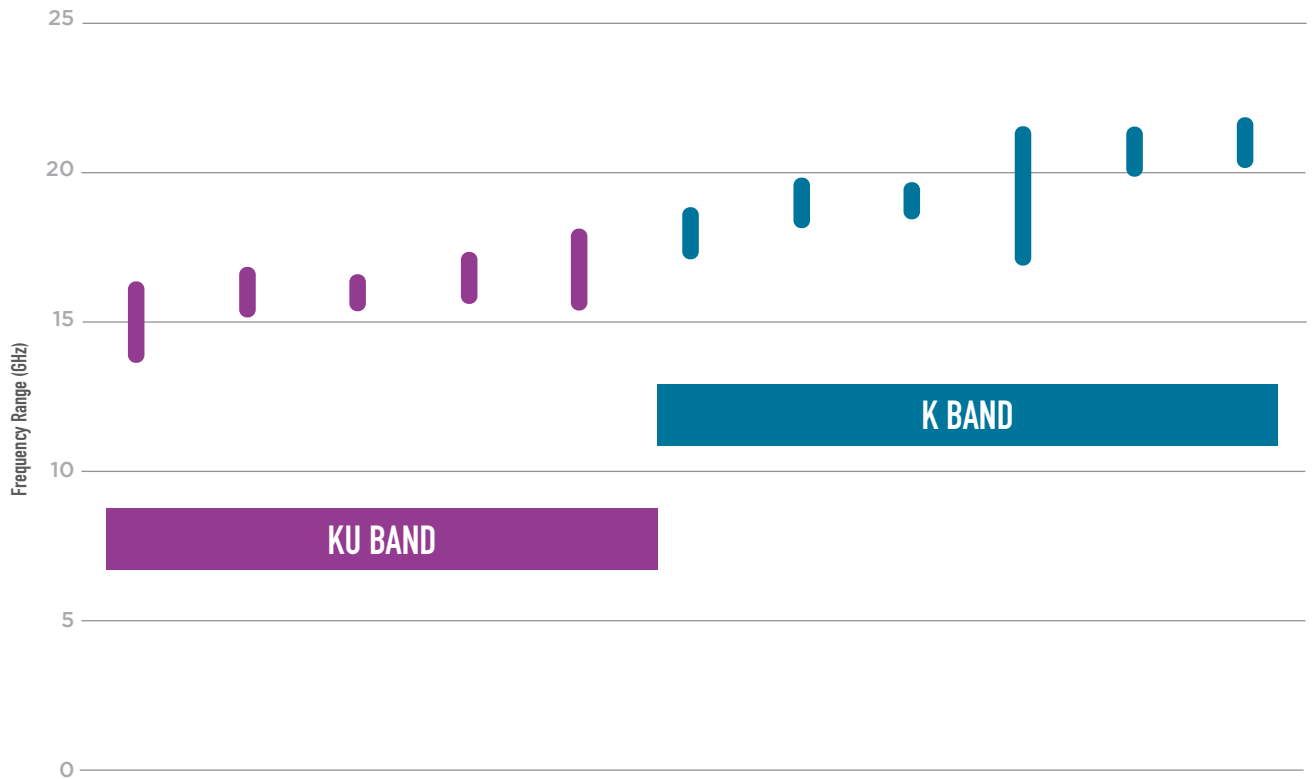

Part Number	B149MC1S	B161LA0S	B160KA1S	B165LA1S	B168MB1S	B180MA1S	B190MB1S	B191KA1S	B192NB2S	B207LA0S	B210LA0S
Center Frequency (GHz)	15	16	16	16.5	16.75	18	19	19.1	19.2	20.7	21
Bandwidth (GHz)	2	1	0.5	1	2	1	1	0.5	4	1	1
<b>Insertion Loss</b>											
@ 25°C (dB)	2.25	4	2.75	2.75	2.5	3	3	4.5	3.75	3.75	3.25
-40°C to +85°C (dB)	2.5	6	3	3	2.75	3.25	3.25	5	4.25	4.25	3.75
VSWR (Ω)	1.58:1	1.67:1	1.58:1	1.58:1	1.58:1	2.0:1	2.0:1	2.0:1	1.92:1	2.0:1	2.0:1
<b>Rejection</b>											
Amplitude (dB)	40	40	40	40	40	40	40	40	40	40	40
LS Range (GHz)	DC - 11.0	DC - 14.75	DC - 14.25	DC - 14.5	DC - 13.4	DC - 16.25	DC - 17.0	DC - 18.0	DC - 15.0	DC - 18.7	DC - 19.25
HS Range (GHz)	18.5 - 23.0	17.3 - 22.00	17.75 - 20.5	18.0 - 25.0	19.25 - 24.00	19.5 - 27.5	20.75 - 27.0	20.0 - 26.0	23.25 - 35.0	22.4 - 27.0	22.75 - 26.75
<b>Dimensions (inches)</b>											
Length	0.350	0.695	0.400	0.400	0.350	0.450	0.450	0.575	0.450	0.450	0.450
Width	0.200	0.250	0.200	0.200	0.200	0.175	0.175	0.200	0.140	0.175	0.175
Height	0.098	0.093	0.098	0.098	0.098	0.093	0.093	0.093	0.088	0.093	0.093
<b>Dimensions (mm)</b>											
Length	8.890	17.653	10.160	10.160	8.890	11.430	11.430	14.605	11.430	11.430	11.430
Width	5.080	6.350	5.080	5.080	5.080	4.445	4.445	5.080	3.556	4.445	4.445
Height	2.489	2.362	2.489	2.489	2.489	2.362	2.362	2.362	2.235	2.362	2.362

## Bandpass Filter Ordering Information

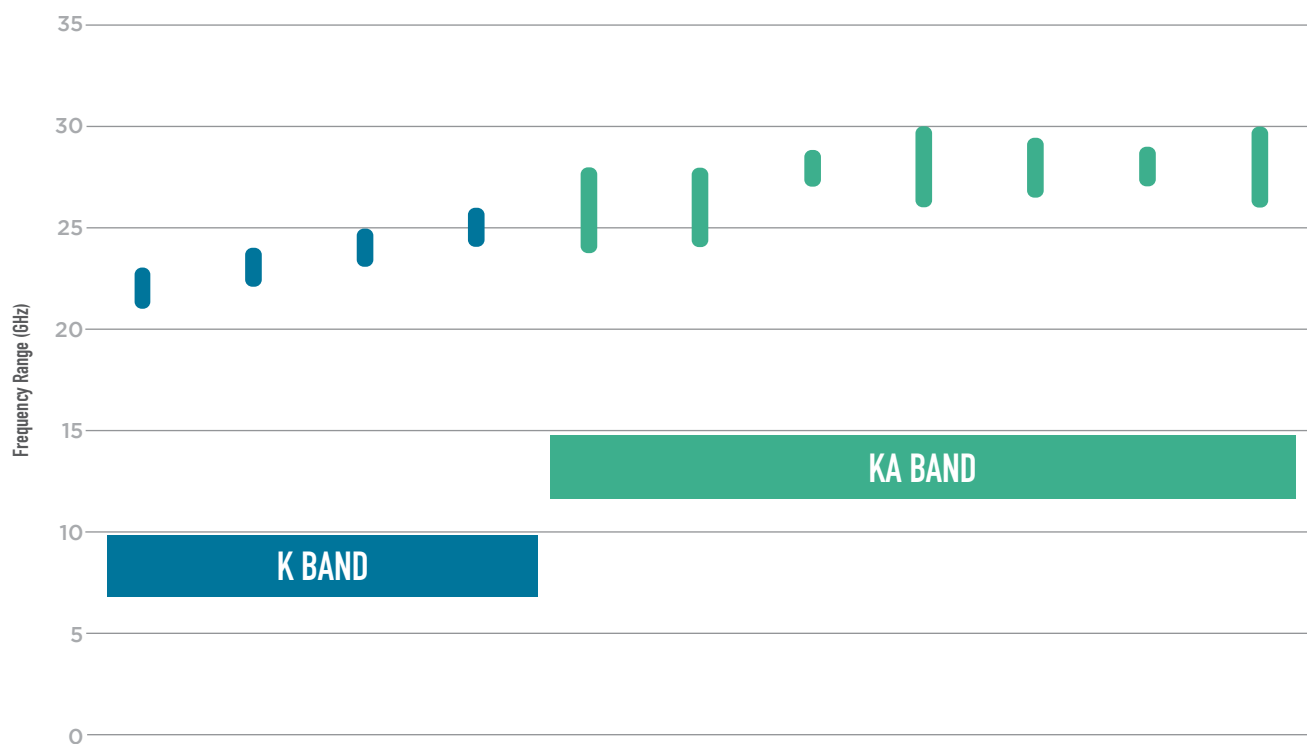

Part Number	B220LAOS	B230LAOS	B240LAOS	B250LAOS	B259MC1S	B260MB2S	B279KB1S	B274MB1S	B280LBOS	B280LAOS	B280MC1S
Center Frequency (GHz)	22	23	24	25	26	26	27.9	28	28	28	28
Bandwidth (GHz)	1	1	1	1	3.25	3	0.85	3	2	1	3
<b>Insertion Loss</b>											
@ 25°C (dB)	4	4	4	4	4	5	3.75	3.5	2	4.5	3.5
-40°C to +85°C (dB)	4.25	4.5	4.5	4.5	4.25	5.25	4.25	3.75	2.5	4.75	4
VSWR (Ω)	2.0:1	2.0:1	2.0:1	2.0:1	1.58:1	1.58:1	1.58:1	1.58:1	1.58:1	1.92:1	1.58:1
<b>Rejection</b>											
Amplitude (dB)	40	40	40	40	30	40	40	40	40	30	30
LS Range (GHz)	DC - 20.25	DC - 21.25	DC - 22.0	DC - 23.0	DC - 23.0	DC - 22.6	DC - 25.9	DC - 24.0	DC - 25.0	DC - 26.0	DC - 24.5
HS Range (GHz)	23.75 - 28.6	25.0 - 31.5	25.7 - 30.0	26.75 - 30.0	29.5 - 41.0	28.6 - 35.0	30.0 - 40.0	31.0 - 39.0	30.75 - 34.25	30.0 - 38.0	31.0 - 41.0
<b>Dimensions (inches)</b>											
Length	0.450	0.450	0.450	0.450	0.217	0.260	0.290	0.450	0.350	0.550	0.217
Width	0.140	0.140	0.140	0.140	0.090	0.120	0.080	0.110	0.120	0.140	0.090
Height	0.088	0.088	0.088	0.088	0.070	0.079	0.070	0.089	0.098	0.083	0.070
<b>Dimensions (mm)</b>											
Length	11.430	11.430	11.430	11.430	5.499	6.604	7.366	11.430	8.890	13.970	5.499
Width	3.556	3.556	3.556	3.556	2.286	3.048	2.032	2.794	3.048	3.556	2.286
Height	2.235	2.235	2.235	2.235	1.778	2.007	1.778	2.261	2.489	2.108	1.778

## Bandpass Filter Ordering Information

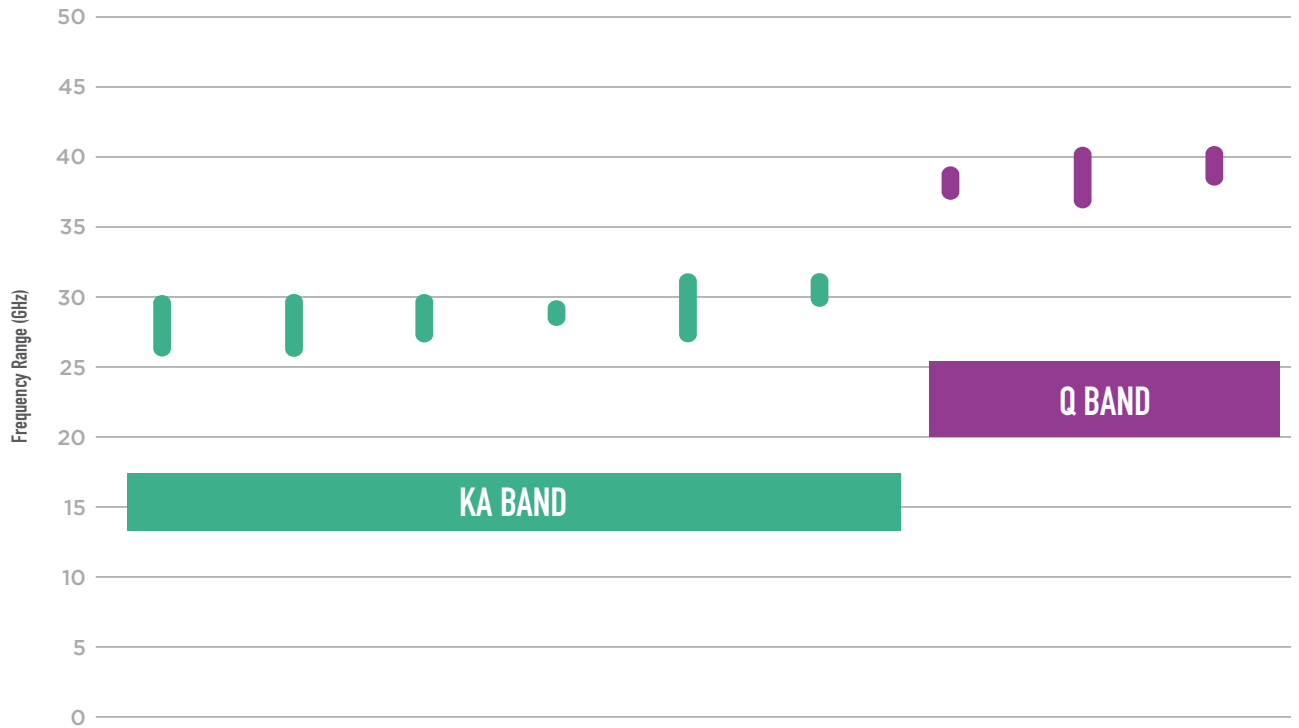

Part Number	B280MD1S	B280MF1S	B285LB2S	B289KA0S	B291MB0S	B305LA0S	B381KD0S	B385MD0S	B393KD0S
Center Frequency (GHz)	28	28	28.5	28.9	29.25	30.5	38.1	38.5	39.3
Bandwidth (GHz)	3	3	2	0.5	3.5	1	1	3	1.4
<b>Insertion Loss</b>									
@ 25°C (dB)	3	3	3.25	4.3	3	4	2.5	2.5	2.5
-40°C to +85°C (dB)	3.5	3.25	3.75	4.8	3.5	4.5	2.75	2.75	2.75
VSWR (Ω)	1.58:1	1.58:1	1.58:1	2.0:1	2.0:1	2.0:1	1.92:1	1.92:1	1.92:1
<b>Rejection</b>									
Amplitude (dB)	35	30	40	40	40	40	40	40	40
LS Range (GHz)	DC - 23.5	DC - 23.0	DC - 25.7	DC - 27.2	DC - 25.25	DC - 28.25	DC - 35	DC - 34.0	DC - 36
HS Range (GHz)	31.75 - 42.0	32.0 - 42.0	31.0 - 40.0	30.6 - 34.0	32.5 - 35.0	32.7 - 38.0	43.0 - 53.0	44.0 - 56.0	45.0 - 53.0
<b>Dimensions (inches)</b>									
Length	0.158	0.158	0.330	0.550	0.450	0.550	0.275	0.275	0.275
Width	0.090	0.090	0.120	0.140	0.140	0.140	0.080	0.080	0.080
Height	0.070	0.070	0.079	0.078	0.088	0.078	0.070	0.070	0.070
<b>Dimensions (mm)</b>									
Length	4.013	4.013	8.382	13.970	11.430	13.970	6.985	6.985	6.985
Width	2.286	2.286	3.048	3.556	3.556	3.556	2.032	2.032	2.032
Height	1.778	1.778	2.007	1.981	2.235	1.981	1.778	1.778	1.778

## Lowpass Filter Selection

Part Number	L157XF3W	L185XF4S	L185XF4W	L204XF4S	L220XH5S	L254XF3S	L288XC3S	L157XG3S
<b>Passband Frequency (GHz)</b>								
3dB Cutoff Frequency	17	18.5	18.5	20.4	22	25.4	28.6	15.7
Low	DC	DC	DC	DC	DC	DC	DC	DC
High	16.5	18	18	20	22.4	25	27.65	15
<b>Insertion Loss</b>								
Max @25°C (dB)	1.0	1.3	1.3	1.3	1.0	1.2	2.0	2.2
<b>Dimensions (inches)</b>								
Length	0.220	0.220	0.220	0.220	0.220	0.220	0.220	0.220
Width	0.180	0.140	0.180	0.140	0.140	0.140	0.140	0.140
Height	0.103	0.118	0.103	0.103	0.103	0.103	0.113	0.103
<b>Dimensions (mm)</b>								
Length	5.59	5.59	5.59	5.59	5.59	5.59	5.59	5.59
Width	4.57	3.56	4.57	3.56	3.56	3.56	3.56	3.56
Height	2.62	3.00	2.62	2.62	2.62	2.62	2.87	2.62

Part Number	L157XF3W	L185XF4S	L185XF4W	L204XF4S	L220XH5S	L254XF3S	L288XC3S
<b>Passband Frequency (GHz)</b>							
3dB Cutoff Frequency	17	18.5	18.5	20.4	22	25.4	28.6
Low	DC	DC	DC	DC	DC	DC	DC
High	16.5	18	18	20	22.4	25	27.65
<b>Insertion Loss</b>							
Max @25°C (dB)	2.0	2.2	2.0	1.8	2.5	1.4	2.0
<b>Dimensions (inches)</b>							
Length	0.220	0.220	0.220	0.220	0.220	0.220	0.220
Width	0.140	0.140	0.140	0.140	0.140	0.140	0.140
Height	0.108	0.098	0.113	0.098	0.118	0.098	0.098
<b>Dimensions (mm)</b>							
Length	5.59	5.59	5.59	5.59	5.59	5.59	5.59
Width	3.56	3.56	3.56	3.56	3.56	3.56	3.56
Height	2.74	2.49	2.87	2.49	3.00	2.49	2.49

## Highpass Filter Selection

Part Number	H060XHXS	H080XHXS	H100XHXS	H120XHXS	H140XHXS	H160XHXS	H168XHXS	H182XHXS
<b>Passband Frequency (GHz)</b>								
3dB Cutoff Frequency	17	18.5	18.5	20.4	22	25.4	28.6	15.7
Low	DC	DC	DC	DC	DC	DC	DC	DC
High	16.5	18	18	20	22.4	25	27.65	15
<b>Insertion Loss</b>								
Max @25°C (dB)	1	1	1	1	1	1	1	1
<b>Dimensions (inches)</b>								
Length	0.450	0.450	0.450	0.450	0.450	0.450	0.450	0.450
Width	0.200	0.200	0.175	0.175	0.175	0.175	0.175	0.175
Height	0.093	0.093	0.083	0.083	0.083	0.083	0.083	0.083
<b>Dimensions (mm)</b>								
Length	11.43	11.43	11.43	11.43	11.43	11.43	11.43	11.43
Width	5.08	5.08	4.45	4.45	4.45	4.45	4.45	4.45
Height	2.36	2.36	2.11	2.11	2.11	2.11	2.11	2.11





# How To Specify a Filter

Type – Bandpass (BP), Lowpass (LP), Highpass (HP) \_\_\_\_\_

Center Frequency, Fc (GHz) Fc = \_\_\_\_\_ GHz

3dB Bandwidth (MHz) 3dB BW = \_\_\_\_\_ MHz

Insertion Loss (IL) @ Fc (dB) IL = \_\_\_\_\_ (dB)

Return Loss (RL) @ Fc: dB Reference – 50 Ohms RL = \_\_\_\_\_ (dB)

Upper Frequency Rejection - \_\_\_\_\_ dB @ \_\_\_\_\_ MHz

Lower Frequency Rejection - \_\_\_\_\_ dB @ \_\_\_\_\_ MHz

Power Handling (Watts) Power (average) = \_\_\_\_\_ Watts,  
Power (peak) = \_\_\_\_\_ Watts

Operating Temperature Range T min = \_\_\_\_\_ °C, T max = \_\_\_\_\_ °C

Mounting Technique: Surface Mount (S) or Chip and Wire Circle one Surface Mount (S) or Chip and Wire  
Note: Microstrip = Chip and Wire

Size (limits) Length \_\_\_\_\_, Width \_\_\_\_\_,  
Thickness \_\_\_\_\_  
Circle one inches or mm

## RF GURU CUSTOM DESIGN FORM, ONLINE

After submitting this form DLI Applications Engineering will contact you. From these discussions, DLI will provide you with further information about possible topologies and predicted filter performance. Then you can decide if a filter on a high-k dielectric is the right option for you.

**Please note:** This is not an order form. There is no obligation until you are confident in our capabilities and actually decide to place an order.



**FILL OUT THE FORM TODAY**

[dliextra.net/DLIFilterGuru/RFGuru.aspx](http://dliextra.net/DLIFilterGuru/RFGuru.aspx)

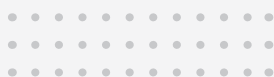
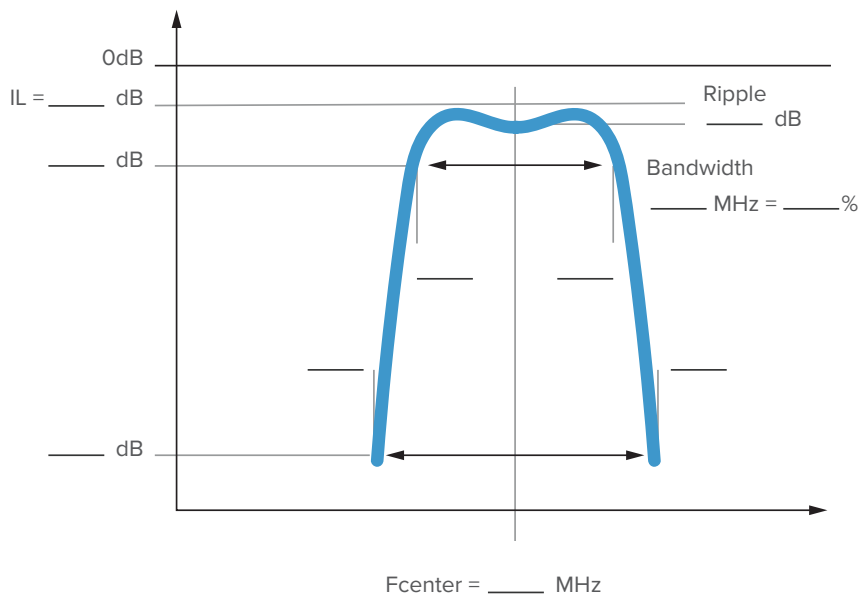

# Cavity Filters

DLI brand cavity filters utilize proprietary high-Q ceramics to enable miniaturized, highly selective low-loss SMD filters. This design dramatically reduces the part's size, compared to traditional air-filled cavity filters, which makes them a perfect choice for applications with SWAP constraints. These cavity filters enable integration with their small size, shielding and surface mount configuration, achieving repeatable performance without the need for mechanical tuning.



## DESIGN ADVANTAGES:

- High quality factor
- 5x Smaller than typical air filled cavities
- True SMD with integrated shielding
- Excellent repeatability without mechanical tuning
- 100% tested and inspected
- Custom designs available
- Narrow bandwidths featured



## APPLICATIONS:

- 5G
- Aerospace
- Military
- Telecom
- SatCom



## KEY CHARACTERISTICS:

- Low loss in passband: 1-3dB typical
- Devices scalable from C to Ku band
- Bandwidth 0.5-3%

Part Number	C079KB1S	C142KB0S
Center Frequency (GHz)	7.85	14.25
Bandwidth (GHz)	0.15	0.5
<b>Insertion Loss</b>		
@ 25°C (dB)	1.74	1.8
-40°C to +85°C (dB)	2.25	2.5
<b>Return Loss</b>		
@ 25°C (dB)	12	12
-40°C to +85°C (dB)	10	10
<b>Rejection</b>		
Amplitude (dB)	50	50
LS Range (GHz)	DC-7.3	DC-13
HS Range (GHz)	8.7-11.0	16-19
<b>Dimensions (inches)</b>		
Length	0.91	0.635
Width	0.24	0.194
Height	0.06	0.06
<b>Dimensions (mm)</b>		
Length	23.12	16.13
Width	6.1	4.93
Height	1.53	1.53

## TYPICAL CAVITY FILTER TRANSMISSION COEFFICIENT

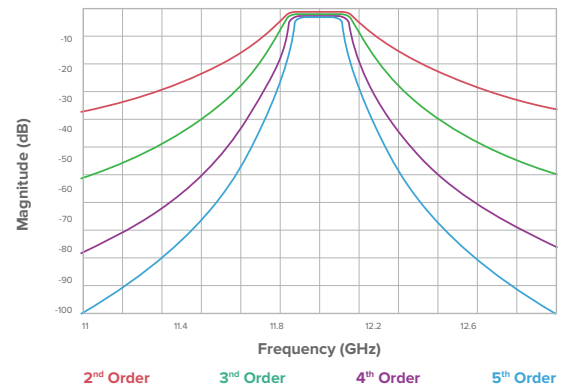

## CERTIFICATION:



# Resonators

DLI brand's ceramic cavity resonators leverage our high-Q, temperature-stable dielectric materials and precision photolithography to realize new capabilities for oscillator applications. One or two port resonator configurations allow the resonator designer a unique opportunity to tightly control all of the important resonator characteristics, such as resonance frequency, Q and coupling coefficient. This makes our cavity resonators an ideal solution for implementation in high-performance, low-cost microwave or mmWave oscillators.

Frequencies of resonator designs range from 1.0 to 67 GHz and can be customized for either solder-surface mount or chip and wire implementation. Contact [KCCSales@knowles.com](mailto:KCCSales@knowles.com) to discuss your resonator needs.



## DESIGN ADVANTAGES:

- Miniature size: .020 x .034 (.5mm x .86mm)
- Simplifies assembly with 1 component



## APPLICATIONS:

- 5G
- Aerospace
- Military
- Telecom



## KEY CHARACTERISTICS:

- Eliminate large, expensive housings
- Measured using RF coplanar probes – no fixtures necessary
- Unloaded Q factor of up to 2000

# Notch Filters

DLI brand notch filters offer attenuation of signals in a specific band, with a compact footprint and extreme repeatability. These are often used in conjunction with a bandpass filter to further attenuate certain frequencies. Contact us for a custom solution for the frequency range you need.

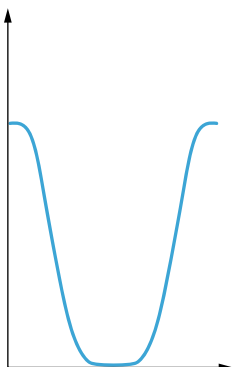

Part Number	N012ME9S	N016MD9S
Notch Frequency (MHz)	1227	1575
Passbands (MHz)	500-1000 and 1500-2000	DC-1300 and 1800-3000
Passband Insertion Loss (dB)	1.5	1.5
Rejection for 1222-1233 MHz (dB)	20	20
Length (in)	0.350	0.250
Width (in)	0.300	0.250
Height (in)	0.103	0.100



# Custom is Standard for Us: Collaboration Is the Key to Top Performance

You choose your path to success. Working with our team of designers and engineers can improve your device in many ways, depending on where you are in your implementation process.



## APPLICATIONS:

- Heat sinks and standoff
- Integrated passive components
- Custom resistor capacitor networks
- Lange couplers, power combiners
- EMI filters
- High-frequency filters
- Microwave-integrated circuits (MIC)
- Bias decoupling and filtering
- Lumped element impedance matching network
- PA stabilization
- Impedance matching and power combining network

### Custom Thin Film Process

### Build-to-Print Service

### Build-to-Spec Service

	Custom Thin Film Process	Build-to-Print Service	Build-to-Spec Service
<b>Part Design</b>	Modified performance of a catalog part	User supplied design	Designed by our team based on your specifications
<b>Performance Goals</b>	Similar to a catalog part	User supplied, design support to achieve as needed	User-defined performance
<b>Preferred Specs</b>	Collaborate to define	On request	User to provide
<b>Material Choices</b>	DLI proprietary ceramics	Varied options, user specified	Varied options, chosen to meet performance goals
<b>100% RF Testing</b>	Standard	On request	Standard



# Engage With Us to Enhance the Outcomes

- Early in the design process to achieve your performance in the smallest footprint, with highest reproducibility and lowest cost of implementation
- Midway in the design process, we can provide material and design insights to improve performance and temperature stability
- Late in the design process, we can assist with design modification and apply our manufacturing expertise to reduce cost

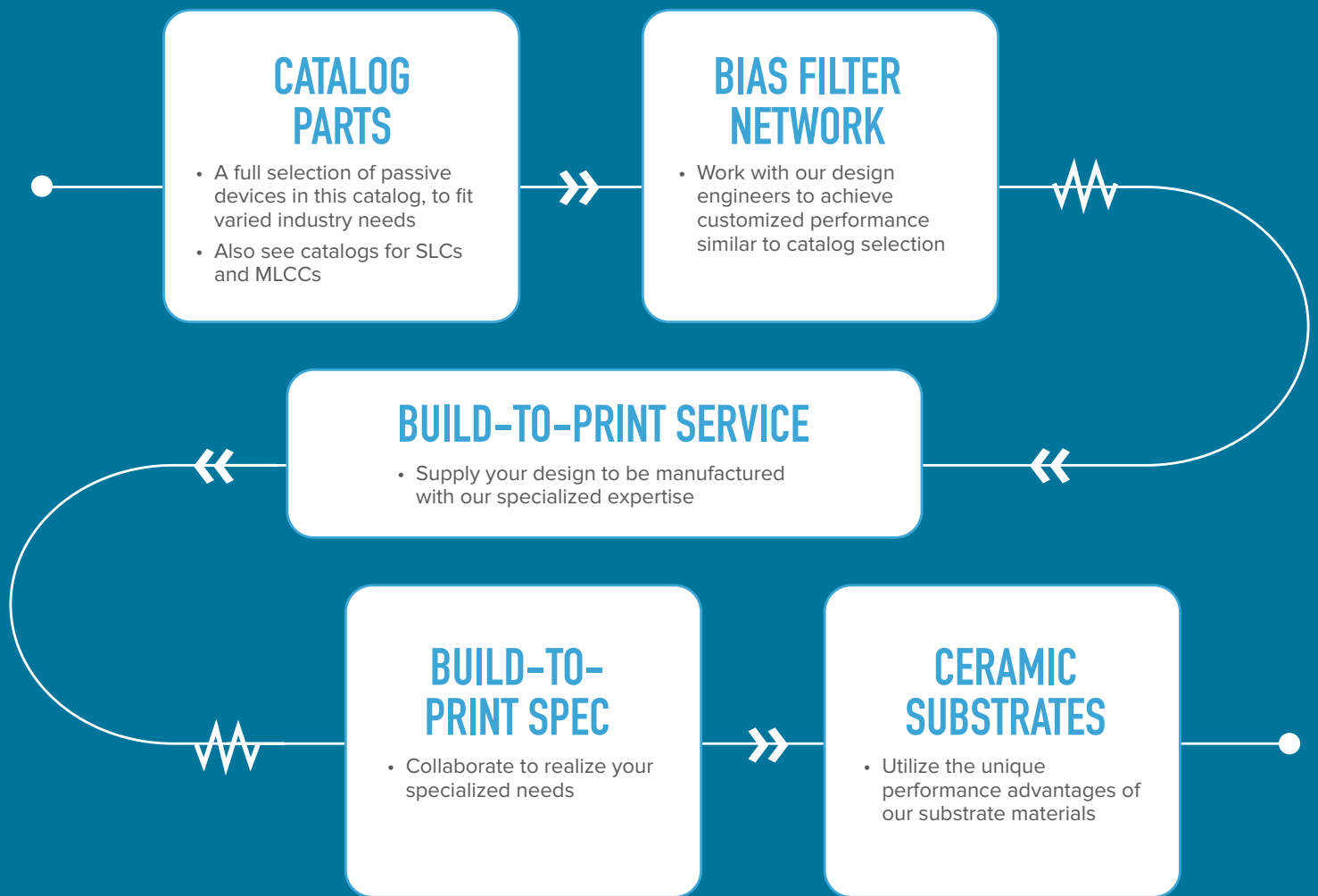

# Integrated R-C Networks

## BIAS FILTER NETWORK

DLI bandpass filters are designed for high-performance microwave applications in a surface mountable package. Using temperature-stable, high-permittivity dielectrics and thin-film processing, these designs offer high selectivity without sacrificing in-band performance.

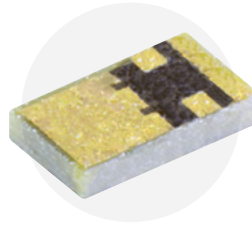

### EQUIVALENT SCHEMATIC REPRESENTATION:

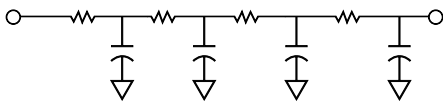

Part Number	Cap Range	Resist	Width	Length	Thickness
B20BHSBN01	40 to 90pF	100 ± 20%	.020 ± .001	.034 ± .001	.006 ± .001
B20BLSBN01	40 to 90pF	100 ± 20%	.020 ± .001	.034 ± .001	.006 ± .001
B28BHBFN01	76 to 171pF	600 ± 20%	.028 ± .001	.053 ± .001	.007 ± .001

## SELF BIAS NETWORK

Knowles Precision Devices takes advantage of the high-permittivity ceramics offered by the DLI brand combined with thin film resistors to provide a device that integrates source decoupling and user-selectable bias resistance.

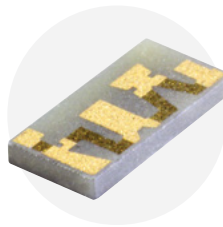

The technique is commonly referred to as a self-bias GaAs FET amplifier – this enables the use of a single DC supply voltage. The gate is at DC ground potential and a negative  $V_{gs}$  is provided by the voltage drop across the selected wire-bond resistors from source to ground – thus setting the desired drain bias current ( $I_{DS}$ ).

The chip network is designed for epoxy attachment to a ground Ridge, one on either side of an FET chip transistor. This provides symmetric, minimum reactance to ground source bypassing for optimum FET gain. By selectively wire bonding from resistor pads to ground, the pair of networks used for each FET provides a wide range of Resistance combinations. The Self Bias Networks, used as a pair, replace 2 standard Parallel plate capacitors and a separate set of bias resistors, reducing parts count, assembly and size.

### EQUIVALENT SCHEMATIC REPRESENTATION:

User wire bond to Ground to select resistance.

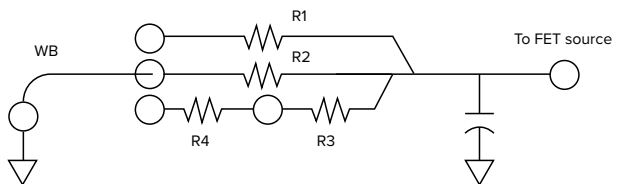

#### Resistor Values:

R1 - 200Ω R3 - 50Ω  
R2 - 100Ω R4 - 20Ω

#### Nominal Capacitance:

50pF

Part Number	Cap Range	Resist	Width	Length	Thickness
B28BJBFN01	76 to 171pF	600 ± 20%	.028 ± .001	.053 ± .001	.007 ± .001
B28BTBFN01	112 to 168pF	600 ± 20%	.028 ± .001	.053 ± .001	.007 ± .001

## TYPICAL APPLICATIONS

- Wireless communication modules
- Ideal varactor decoupling element
- High gain RF/Microwave modules
- Ideal GaAs FET gate biasing device
- MMIC multichip modules
- MIC broadband high gain RF/Microwave modules
- Bias line voltage divider and integrated decoupling capacitor

## CERTIFICATION:



# Integrated R-C Networks

## C-R-C DECOUPLING NETWORKS (aka. RF Blocking Networks)

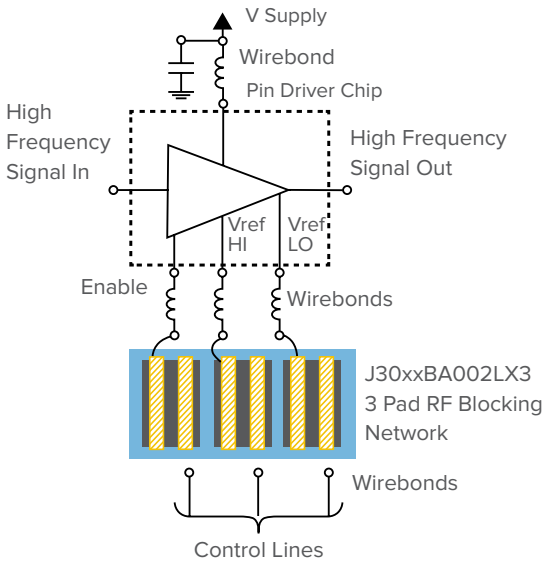

## SEGMENT EQUIVALENT SCHEMATIC REPRESENTATION

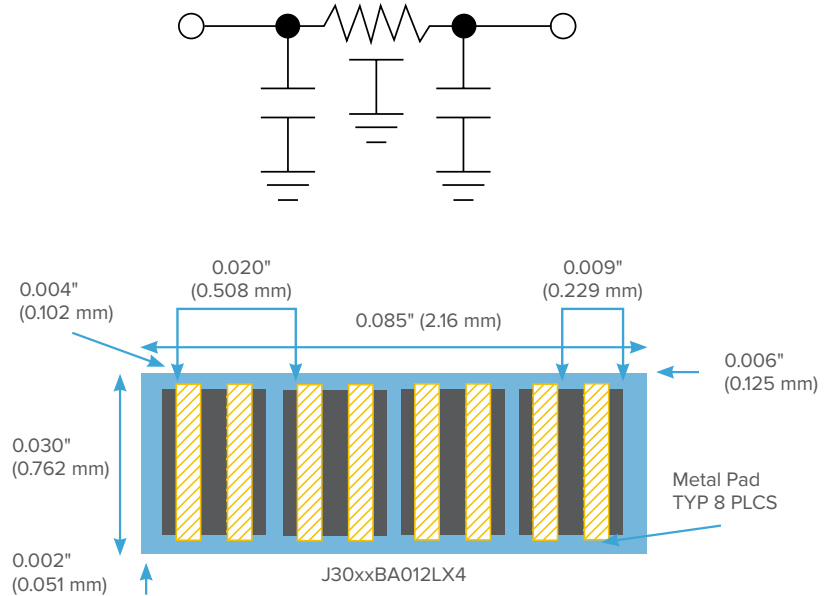

## APPLICATIONS:

- Heatsinks and standoffs
- Integrated passive components
- Custom resistor capacitor networks
- Lange couplers, power combiners
- EMI filters
- High-frequency filters
- Microwave-integrated circuits (MIC)
- Bias decoupling and filtering
- Lumped element impedance matching network
- PA stabilization
- Impedance matching and power combining network

Part Number	J30BLBA032LX1	J30BLBA022LX2	J30BLBA002LX3	J30BLBA012LX4	J30BJBA032LX1	J30BJBA022LX2	J30BJBA002LX3	J30BJBA012LX4
Number of RC Segments	1	2	3	4	1	2	3	4
Nominal Resistance (pad to pad) ( $\Omega$ )	10	10	10	10	10	10	10	10
Capacitance (typical) (pF)	30	30	30	30	45	45	45	45
Maximum DF	3.00%	3.00%	3.00%	3.00%	3.00%	3.00%	3.00%	3.00%
TCC	X7R	X7R	X7R	X7R	X7R	X7R	X7R	X7R
Rated Voltage (Vdc)	25	25	25	25	25	25	25	25
Attachment Method	All are configured for Chip & Wire attachment							
Termination Finish	100 $\mu$ inches Au, minimum							
<b>Dimensions (inches)</b>								
Length	0.025	0.045	0.065	0.085	0.250	0.045	0.065	0.085
Width	0.030	0.030	0.030	0.030	0.030	0.030	0.030	0.030
<b>Dimensions (mm)</b>								
Length	0.64	1.14	1.65	2.16	6.35	1.14	1.65	2.16
Width	0.76	0.76	0.76	0.76	0.76	0.76	0.76	0.76

# Couplers

The high-frequency directional couplers incorporate DLI's high-permittivity ceramic materials to provide small size and minimal performance variation over temperature.

These couplers offer a turnkey solution in SMD or chip and wire format for high-frequency power monitoring, with the SMD series covering up to 40 GHz.

While custom coupling values are achievable, 3, 10 and 20 dB offerings are available with common footprints for maximum flexibility.

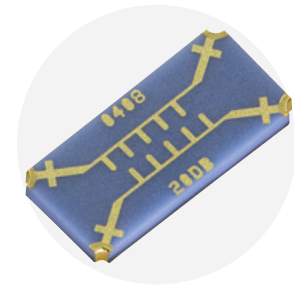

Part Number	Fl (GHz)	Fh (GHz)	Coupling (dB)	Passband Coupling Variation Typ. (dB)	Excess Insertion Loss Typ. (dB)	Retun Loss Typ. (dB)	Isolation Typ. (dB)	Directivity Typ. (dB)	Mounting Type	Length (in)	Width (in)	Height (in)	Length (mm)	Width (mm)	Height (mm)
FPC06700	5.9	6.5	3	±1	0.75	17	20	17	SMD	0.425	0.250	0.020	10.80	6.35	0.51
FPC06630	9	11	3	±1	0.5	20	18	15	SMD	0.286	0.180	0.015	7.26	4.57	0.38
FPC06701	10.7	12.75	3	±1	0.5	12	15	12	SMD	0.255	0.155	0.015	6.48	3.94	0.38
FPC07183	24	33	3	±1	1	12	15	12	SMD	0.180	0.110	0.010	4.57	2.79	0.25
FPC07234	2	18	10	±1.5	0.8	12	20	10	SMD	0.500	0.150	0.030	12.70	3.81	0.76
FPC09291	2	18	10	±1.5	0.8	12	20	10	Chip and Wire	0.500	0.150	0.030	12.70	3.81	0.76
FPC06073	4	8	10	±0.75	0.3	20	32	22	SMD	0.170	0.080	0.015	4.32	2.03	0.38
FPC06149	4	8	10	±0.75	0.5	15	30	20	Chip and Wire	0.180	0.080	0.015	4.57	2.03	0.38
FPC06719	6	18	10	±1.0	0.5	15	23	13	SMD	0.255	0.100	0.015	6.48	2.54	0.38
FPC07643	6	18	10	±1.0	0.5	15	23	13	Chip and Wire	0.255	0.100	0.015	6.48	2.54	0.38
FPC06074	8	12	10	±0.2	0.5	20	30	20	SMD	0.120	0.080	0.015	3.05	2.03	0.38
FPC06150	8	12	10	±1.5	1	12	24	14	Chip and Wire	0.130	0.090	0.015	3.30	2.29	0.38
FPC06075	12	18	10	±1.25	0.3	15	25	14	SMD	0.100	0.080	0.015	2.54	2.03	0.38
FPC06151	12	18	10	±0.75	0.75	15	20	10	Chip and Wire	0.100	0.080	0.015	2.54	2.03	0.38
FPC07182	20	40	10	±1.5	0.3	10	23	13	SMD	0.065	0.050	0.010	1.65	1.27	0.25
FPC07180	2	18	20	±1.0	1	15	25	5	SMD	0.500	0.150	0.015	12.70	3.81	0.38
FPC06076	4	8	20	±2.5	0.75	20	35	15	SMD	0.170	0.080	0.015	4.32	2.03	0.38
FPC06152	4	8	20	±1.5	0.25	25	40	20	Chip and Wire	0.180	0.080	0.015	4.57	2.03	0.38
FPC06913	6	18	20	±1.0	0.3	18	30	10	SMD	0.180	0.110	0.015	4.57	2.79	0.38
FPC07337	6	18	20	±1	0.7	15	25	5	Chip and Wire	0.180	0.100	0.015	4.57	2.54	0.38
FPC06153	8	12	20	±1.25	0.2	20	35	15	Chip and Wire	0.130	0.090	0.015	3.30	2.29	0.38
FPC06302	8	12	20	±1.25	1	20	35	15	SMD	0.120	0.080	0.015	3.05	2.03	0.38
FPC06078	12	18	20	±0.75	0.3	23	35	15	SMD	0.100	0.080	0.015	2.54	2.03	0.38
FPC06154	12	18	20	±1.5	0.3	10	30	10	Chip and Wire	0.100	0.080	0.015	2.54	2.03	0.38
FPC07181	20	40	20	±1.5	0.3	12	30	10	SMD	0.065	0.050	0.010	1.65	1.27	0.25
FPC06077	8	12	25	±1.0	0.3	18	35	10	SMD	0.120	0.080	0.015	3.05	2.03	0.38
FPC06881	0	25	20	±1.5	2.85	12			SMD	0.060	0.088	0.010	1.52	2.24	0.25
FPC07803	0	40	20	±2	3	12			SMD	0.060	0.088	0.010	1.52	2.24	0.25
FPC06882	0	25	30	±3	2	12			SMD	0.060	0.088	0.010	1.52	2.24	0.25
FPC07802	0	40	30	±2	2.5	12			SMD	0.060	0.088	0.010	1.52	2.24	0.25



# Power Dividers

DLI brand power dividers incorporate low-loss, high-permittivity ceramics, providing miniaturized dimensions and temperature-stable RF performance. The integrated thin film resistors improve phase and amplitude balance over broadband devices. There are two styles: Wilkinson and resistive power dividers, and these designs are configured for attachment with either solder or conductive adhesive. Due to their compact size and proven performance, DLI brand power dividers are a superior option over integration in a soft board material with discrete resistors.

## CERTIFICATION:

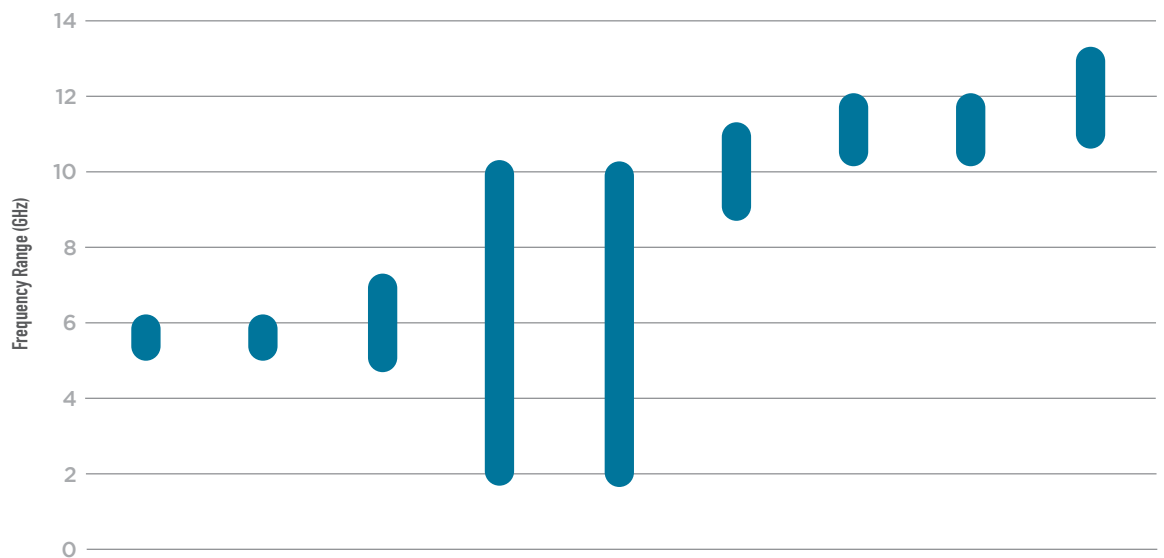

Part Number	PDW08606	PDW08607	PDW06398	PDW06038	PDW06041	PDW06399	PDW08604	PDW08605	PDW06400
Configuration	2:1	4:1	2:1	2:1	2:1	2:1	2:1	4:1	2:1
Nominal Power Splitting	3dB	6dB	3dB	3dB	3dB	3dB	3dB	6dB	3dB
Freq. Low (GHz)	5.3	5.3	5	2	2	9	10.6	10.6	11
Freq. High (GHz)	5.9	5.9	7	10	10	11	11.8	11.8	13
Max. Amplitude Balance (dB)	±0.15	±0.25	±0.20	±0.25	±0.25	±0.1	±0.25	±0.25	±0.25
Max. Phase Balance (degrees)	±2.5	±2.5	±3.0	±5.0	±5.0	±1.0	±1.75	±5.0	±4.0
Typical Excess Insertion Loss (dB)	0.3	0.5	0.25	1.25	1.25	0.4	0.4	0.4	0.5
Typical Return Loss (dB)	20	16	20	20	20	20	15	20	25
Typical Isolation (dB)	20	20	18	20	20	18	15.5	20	20
Mounting	SMD	SMD	SMD	SMD	Chip & Wire	SMD	SMD	SMD	SMD
Length (inches)	0.115	0.260	0.120	0.400	0.400	0.150	0.085	0.190	0.130
Width (inches)	0.115	0.175	0.240	0.250	0.250	0.100	0.085	0.125	0.130
Height (inches)	0.030	0.030	0.015	0.020	0.020	0.015	0.020	0.020	0.015
Length (mm)	2.921	6.604	3.048	10.16	10.16	3.81	2.159	4.826	3.302
Width (mm)	2.921	4.445	6.096	6.35	6.35	2.54	2.159	3.175	3.302
Height (mm)	0.762	0.762	0.381	0.508	0.508	0.381	0.508	0.508	0.381



# Power Dividers Continued



## DESIGN ADVANTAGES:

- Small size
- Solder surface mountable
- Excellent repeatability
- Versions available



## APPLICATIONS:

- 5G
- Aerospace
- Military
- Telecom



## KEY CHARACTERISTICS:

- Low excess insertion loss
- High isolation
- Excellent phase and amplitude balance for Wilkinson Power Dividers only
- Well-matched on all ports

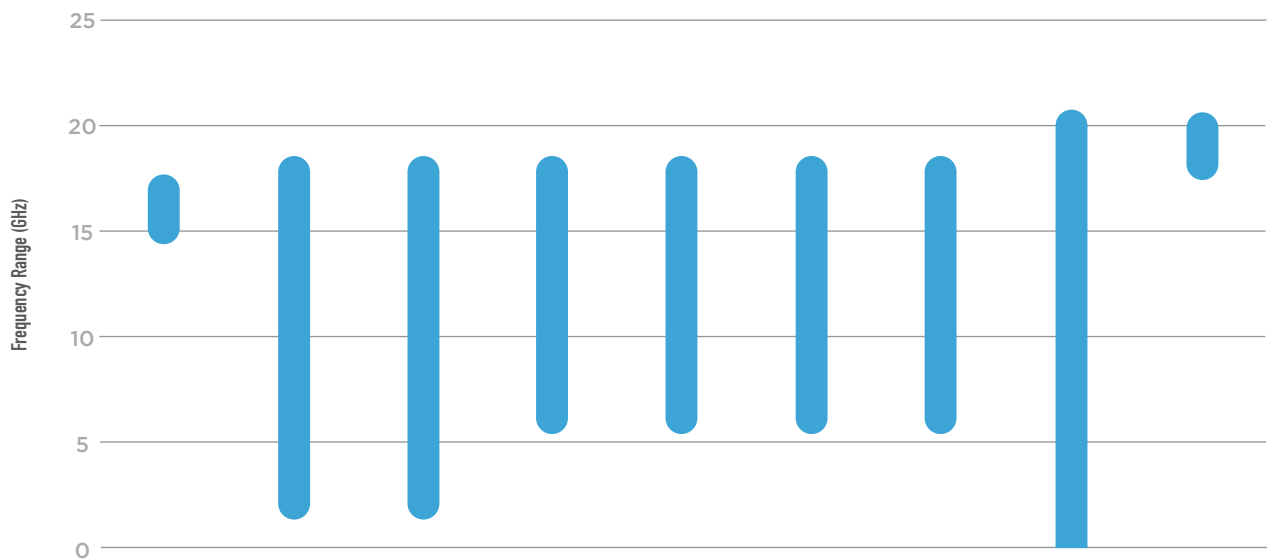

Part Number

PDW06401

PDW06407

PDW06933

PDW05758

PDW06011

PDW06089

PDW07948

PDR06390

PDW07691

Configuration	2:1	2:1	2:1	2:1	2:1	4:1	4:1	2:1	2:1
Nominal Power Splitting	3dB	3dB	3dB	3dB	3dB	6dB	6dB	6dB	3dB
Freq. Low (GHz)	15	2	2	6	6	6	6	0	18
Freq. High (GHz)	17	18	18	18	18	18	18	20	20
Max. Amplitude Balance (dB)	±0.1	±0.6	±0.6	±0.5	±0.5	±0.75	±0.75	±0.6	±0.25
Max. Phase Balance (degrees)	±2.0	±8.0	±8.0	±1.25	±1.25	±9.0	±9.0	±3.0	±1.25
Typical Excess Insertion Loss (dB)	0.25	2.5	2.5	2.35	0.9	0.8	0.8	0.25	0.25
Typical Return Loss (dB)	20	18	18	20	16	15	15	20	20
Typical Isolation (dB)	20	20	20	25	25	20	20	6	20
Mounting	SMD	SMD	Chip & Wire	SMD	Chip & Wire	SMD	Chip & Wire	SMD	SMD
Length (inches)	0.120	0.600	0.600	0.185	0.185	0.250	0.250	0.075	0.100
Width (inches)	0.120	0.180	0.180	0.160	0.160	0.300	0.300	0.070	0.100
Height (inches)	0.015	0.020	0.020	0.020	0.020	0.020	0.020	0.010	0.015
Length (mm)	3.048	15.24	15.24	4.699	4.699	6.35	6.35	1.905	2.54
Width (mm)	3.048	4.572	4.572	4.064	4.064	7.62	7.62	1.778	2.54
Height (mm)	0.381	0.508	0.508	0.508	0.508	0.508	0.508	0.254	0.381



# Power Dividers Continued



**Left:** Example of a Wilkinson Power Divider PDW  
**Right:** Example of a Resistive Power Divider PDR (note: shows mounting configuration on bottom side of the part)

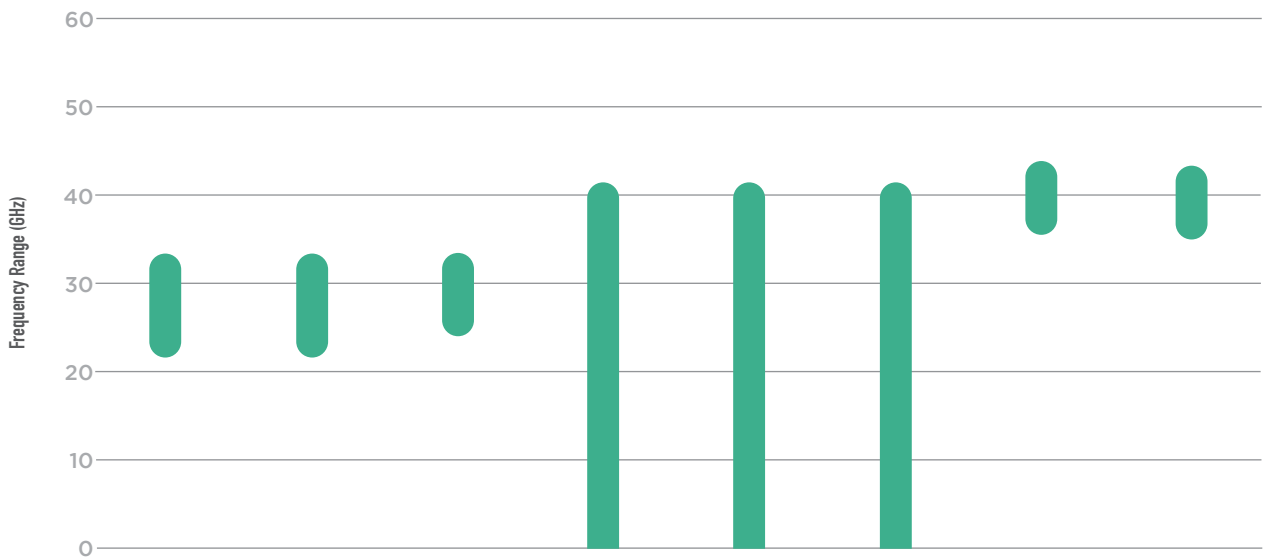
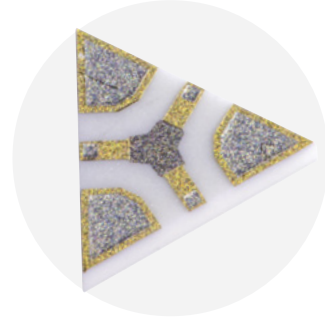

Part Number	PDW07069	PDW06984	PDW07630	PDR05848	PDR06120	PDR06380	PDW08323	PDW08324
Configuration	4:1	2:1	2:1	2:1	2:1	2:1	2:1	4:1
Nominal Power Splitting	6dB	3dB	3dB	6dB	6dB	6dB	3dB	6dB
Freq. Low (GHz)	24	25	25	0	0	0	37	37
Freq. High (GHz)	32	32	32	40	40	40	42	42
Max. Amplitude Balance (dB)	±0.25	±0.25	±0.25	±0.6	±0.6	±0.6	±0.5	±0.75
Max. Phase Balance (degrees)	±5.0	±2.5	±5.0	±3.0	±3.0	±3.0	±5.75	±5.0
Typical Excess Insertion Loss (dB)	1	0.6	0.25	0.5	0.5	0.5	0.75	0.75
Typical Return Loss (dB)	15	15	17	20	20	20	15	15
Typical Isolation (dB)	20	15	15	6	6	6	20	25
Mounting	SMD	SMD	SMD	SMD (AuSn)	Epoxy	SMD	SMD	SMD
Length (inches)	0.140	0.085	0.070	0.075	0.075	0.075	0.070	0.140
Width (inches)	0.170	0.095	0.070	0.065	0.065	0.065	0.070	0.170
Height (inches)	0.010	0.010	0.010	0.010	0.010	0.010	0.010	0.010
Length (mm)	3.556	2.159	1.778	1.905	1.905	1.905	1.778	3.556
Width (mm)	4.318	2.413	1.778	1.651	1.651	1.651	1.778	4.318
Height (mm)	0.254	0.254	0.254	0.254	0.254	0.254	0.254	0.254



# Gain Equalizers

The DLI brand of gain equalizers are designed to compensate for module gain slope. Excellent repeatable microwave performance is achieved by application of precision thin-film fabrication and high-permittivity ceramic materials. This unique design solution provides near ideal R-C frequency response that is far superior to “stacked R-C chip” assemblies.



## DESIGN ADVANTAGES:

- Many designs smaller than 0402 case size
- Ease of integration
- Customization available



## APPLICATIONS:

- Broadband Microwave modules: EW, ECM, ECCM
- Equalizer is utilized as a compensation circuit to correct for loss slope created by other circuit elements such as amplifiers



## KEY CHARACTERISTICS:

- Superior microwave performance
- Reduced cost
- Flatten amplifier gain response
- Positive gain slope

## CERTIFICATION:

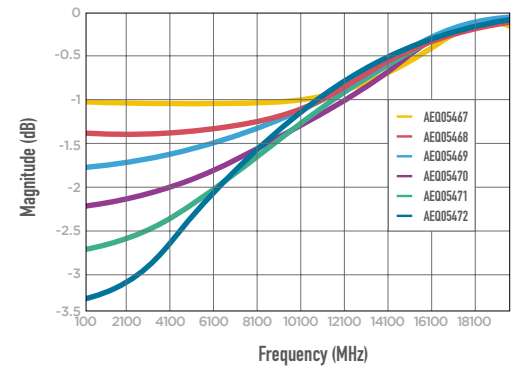
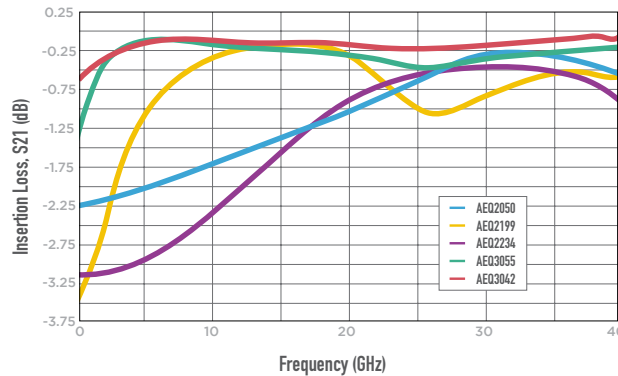

## ORDERING INFORMATION:

Epoxy	Solderable	Lp	Wp	G	Nominal Slope	Length	Width	Thickness
AEQ2050	AEQ05510	9 ± 1	14 ± 1	8 ± 1	2.25 dB	30 ± 2	18 ± 2	5 ± 1
AEQ2199	AEQ05246	7 ± 1		12 ± 1	3.5 dB	28 ± 2	16 ± 2	7 ± 1
AEQ2234	AEQ06042	8 ± 1		12 ± 1	3.25 dB	32 ± 1		5 ± 1
AEQ3042	AEQ3042	17.5 ± 1	17.5 ± 1	3 ± 1	0.6 dB	40 ± 2	20 ± 2	6 ± 1
AEQ3055	AEQ3055	15.4 ± 1	18.4 ± 1	7.2 ± 1	1.5 dB			
AEQ05467	AEQ05467	7 min	14 ± 1	10	1.0 dB	28 ± 1	16 ± 1	7 ± 1
AEQ05468	AEQ05468				1.5 dB			
AEQ05469	AEQ05469				2.0 dB			
AEQ05470	AEQ05470				2.5 dB			
AEQ05471	AEQ05471				3.0 dB			
AEQ05472	AEQ05472				3.5 dB			



## GAIN EQUALIZER KIT

Our Gain Equalizers offer gain slope compensation in a single component.

Benefits include:

- Superior microwave performance
- Excellent repeatability
- Ease of assembly
- Custom designs
- Small size (0402 or smaller)
- Products up through 40GHz



	AEQ02050	AEQ02199	AEQ02234	AEQ03055	AEQ03042
Low Freq. Loss	2.2dB	3.0dB	3.5dB	1.6dB	0.8dB
Min. Loss Freq.	31.0GHz	15.0GHz	27.0GHz	5.0GHz	5.0GHz
Mounting Method	Epoxy	Epoxy	Epoxy	Solder	Solder

## EW GAIN EQUALIZER KIT

Benefits include:

- Superior microwave performance
- Excellent repeatability
- Ease of assembly
- Custom designs
- Small size (0302)
- Designed for 2-18GHZ application



	AEQ05467	AEQ05468	AEQ05469	AEQ05470	AEQ05471	AEQ05472
Low Freq. Loss	1.0dB	1.35dB	1.75dB	2.25dB	2.75dB	3.25dB
Min. Loss Freq.	18GHz	18GHz	18GHz	18GHz	18GHz	18GHz
Mounting Method	Solder/ Epoxy	Solder/ Epoxy	Solder/ Epoxy	Solder/ Epoxy	Solder/ Epoxy	Solder/ Epoxy



## MMWAVE FILTERS:

# Addressing the Challenges Presented by 5G

Based on decades of experience working with mmWave filtering solutions, Knowles Precision Devices has a product line of **mmWave filter solutions** based on DLI filter technology that addresses the challenges outlined below of working with 5G technology.

### SHRINKING WAVELENGTHS

At 700MHz, the wavelength in free space is about 430mm, and at 2.6GHz, wavelengths are 115mm. Yet at 39GHz, wavelengths are only 7.7mm.

### REDUCED SIZE OF THE RF FRONT END

As wavelength shrinks so do antenna sizes, and for arrays to avoid diffraction effects, antenna spacing needs to be similarly shrunk. Filters in RF front ends need to be compact.

### INCREASE IN NUMBER OF RF PATHS RF FRONT END

The enabling technologies for mmWave, beam steering and MIMO rely on arrays of antennas, which, in turn, rely on arrays of RF paths — further necessitating compact filtering components.

### INCREASED TEMPERATURE

In dense board environments temperatures rise, and front ends need to operate at increased temperature and with inherent temperature stability.

### INCREASED NEED FOR PERFORMANCE REPEATABILITY

High-frequency circuits are sensitive to variations in performance from part to part. Repeatability in filter component performance is key to avoid costly "set-at-test" scenarios.

### EVER-PRESENT NEED TO PERFORM

Filter components for the mmWave RF front end need to encompass all these factors, and they still need to perform to ensure the best spectral efficiency and ejection possible.

Using specialized topologies and material formulations, Knowles Precision Devices created off-the-shelf catalog designs available up to 42 GHz that are 20 times smaller than the current alternatives.



### MMWAVE FILTER KEY FEATURES & BENEFITS:

- Filter size reduction of up to 20x
- Stable operation from -55C to +125C
- Precise manufacturing means no tuning
- Performance—very broad band, high rejection and low insertion loss

# Specialty Kits

## 5G KIT

Knowles Precision Devices meet the 5G mmWave filter challenge through our DLI filter technology:

- Shrinking wavelengths
- Reduce size of the RF front end
- Increase in number of RF paths RF front end
- Increased temperature
- Increased need for performance repeatability

### 5G Kit 26GHz - B259MC1S

PART NUMBER	TYPE	FC (GHz)	FL	FH	INSERTION LOSS (@FC, dB 25°C)	L, INCHES (mm)	W, INCHES (mm)	H, INCHES (mm)
B259MC1S	26GHz Bandpass	25.9	24.25	27.5	3.5	0.2165 (5.4991)	0.090 (2.286)	0.070 (1.778)
DEB-B259MC1S	26GHz Bandpass, mounted on eval board	25.9	24.25	27.5	3.5			
B274MB1S	28GHz Bandpass	28	25	29.5	3.25	0.450 (11.43)	0.110 (2.794)	0.089 (2.2606)
B280LB0S	28GHz Bandpass	28	27	29	1.5	0.350 (8.89)	0.120 (3.048)	0.098 (2.4892)
B280LA0S	28GHz Bandpass	28	27.5	28.5	4	0.550 (13.97)	0.140 (3.556)	0.083 (2.1082)
FPC07182	20dB Coupler		20	40	0.3	0.065 (1.651)	0.050 (1.27)	0.010 (0.254)
FPC07181	10dB Coupler		20	40	0.6	0.065 (1.651)	0.050 (1.27)	0.010 (0.254)
PDW07069	4-way Power Divider		25	32	1	0.140 (3.556)	0.170 (4.318)	0.010 (0.254)
PDW07630	2-way Power Divider		25	32	0.25	0.070 (1.778)	0.070 (1.778)	0.010 (0.254)

### 5G Kit 28GHz - B274MB1S

PART NUMBER	TYPE	FC (GHz)	FL	FH	INSERTION LOSS (@FC, dB 25°C)	L, INCHES (mm)	W, INCHES (mm)	H, INCHES (mm)
B274MB1S	28GHz Bandpass	28	26.5	29.5	3.25	0.450 (11.43)	0.110 (2.794)	0.089 (2.2606)
DEB-B274MB1S	28GHz Bandpass, mounted on eval board	28	26.5	29.5	3.25			
B280LB0S	28GHz Bandpass	28	27	29	1.5	0.350 (8.89)	0.120 (3.048)	0.098 (2.4892)
B280LA0S	28GHz Bandpass	28	27.5	28.5	4	0.550 (13.97)	0.140 (3.556)	0.083 (2.1082)
PDW07069	4-way Power Divider		25	32	1	0.140 (3.556)	0.170 (4.318)	0.010 (0.254)
PDW07630	2-way Power Divider		25	32	0.25	0.070 (1.778)	0.070 (1.778)	0.010 (0.254)
FPC07182	20dB Coupler		20	40	0.3	0.065 (1.651)	0.050 (1.27)	0.010 (0.254)
FPC07181	10dB Coupler		20	40	0.6	0.065 (1.651)	0.050 (1.27)	0.010 (0.254)

### 5G Kit 39GHz - B385MDOS

PART NUMBER	TYPE	FC (GHz)	FL	FH	INSERTION LOSS (@FC, dB 25°C)	L, INCHES (mm)	W, INCHES (mm)	H, INCHES (mm)
B385MDOS	39GHz Bandpass	38.5	37	40	2.5	0.275 (6.985)	0.080 (2.032)	0.075 (1.905)
DEB-B385MDOS	39GHz Bandpass, mounted on eval board	38.5	37	40	2.5			
PDW08323	2-way Power Divider		37	42	0.5	0.070 (1.778)	0.070 (1.778)	0.010 (0.254)
PDW08324	4-way Power Divider		37	42	0.7	0.170 (4.318)	0.140 (3.556)	0.010 (0.254)
FPC07182	20dB Coupler		20	40	0.3	0.065 (1.651)	0.050 (1.27)	0.010 (0.254)
FPC07181	10dB Coupler		20	40	0.6	0.065 (1.651)	0.050 (1.27)	0.010 (0.254)



# SatCom Offerings

## C BAND

PART NUMBER	TYPE	FREQUENCY RANGE, GHz	SIZE L X W X H, INCHES (mm)
B056RC4S	Bandpass Filter Octave	4.0-8.0	0.450 (11.43) x 0.230 (5.842) x 0.100 (2.54)
B038NC4S	Bandpass Filter Downlink	3.4-4.2	0.550 (13.97) x 0.220 (5.588) x 0.108 (2.743)
B040RG9S	Bandpass Filter Downlink	2.0-6.0	0.620 (15.75) x 0.280 (7.11) x 0.093 (2.36)
B061MB6S	Bandpass Filter Downlink	5.85-6.425	0.450 (11.43) x 0.200 (5.08) x 0.098 (2.48)
PDW06398	Power Divider 2:1 Splitter	5.0-7.0	0.120 (3.048) x 0.240 (6.096) x 0.015 (0.381)
FPC06700	Directional Coupler 3 dB	5.9-6.5	0.425 (10.80) x 0.250 (6.35) x 0.020 (0.508)
FPC06073	Directional Coupler 10 dB	4.0-8.0	0.170 (4.318) x 0.080 (2.032) x 0.015 (0.381)
FPC06149	Directional Coupler 10 dB	4.0-8.0	0.180 (4.572) x 0.080 (2.032) x 0.015 (0.381)
FPC06076	Directional Coupler 20 dB	4.0-8.0	0.170 (4.318) x 0.080 (2.032) x 0.015 (0.381)
FPC06152	Directional Coupler 20 dB	4.0-8.0	0.180 (4.572) x 0.080 (2.032) x 0.015 (0.381)

## X BAND

PART NUMBER	TYPE	FREQUENCY RANGE, GHz	SIZE L X W X H, INCHES (mm)
B096QC2S	Bandpass Filter Octave	8.0-12.0	0.400 (10.16) x 0.180 (4.572) x 0.100 (2.54)
PDW06399	Power Divider 2:1 Splitter	9.0-11.0	0.150 (3.81) x 0.100 (2.54) x 0.015 (0.381)
FPC06630	Directional Coupler 3 dB	9.0-11.0	0.286 (7.264) x 0.180 (4.572) x 0.015 (0.381)
FPC06074	Directional Coupler 10 dB	8.0-12.0	0.120 (3.048) x 0.080 (2.032) x 0.015 (0.381)
FPC06150	Directional Coupler 10 dB	8.0-12.0	0.130 (3.302) x 0.090 (2.286) x 0.015 (0.381)
FPC06153	Directional Coupler 20 dB	8.0-12.0	0.130 (3.302) x 0.090 (2.286) x 0.015 (0.381)
FPC06302	Directional Coupler 20 dB	8.0-12.0	0.120 (3.048) x 0.080 (2.032) x 0.015 (0.381)
FPC06701	Directional Coupler 3 dB	10.7-12.75	0.255 (6.48) x 0.155 (3.94) x 0.015 (0.381)

## KU BAND

PART NUMBER	TYPE	FREQUENCY RANGE, GHz	SIZE L X W X H, INCHES (mm)
B119LB1S	Bandpass Filter Downlink	11.7-12.2	0.450 (11.43) x 0.200 (5.08) x 0.098 (2.488)
B119MB1S	Bandpass Filter Downlink	4.0-10.0	0.450 (11.43) x 0.200 (5.08) x 0.098 (2.488)
B142LA2S	Bandpass Filter Downlink	14.0-14.5	0.575 (14.60) x 0.200 (5.08) x 0.093 (2.36)
PDW06400	Power Divider 2:1 Splitter	11.0-13.0	0.130 (3.302) x 0.130 (3.302) x 0.015 (0.381)
PDW06401	Power Divider 2:1 Splitter	15.0-17.0	0.120 (3.048) x 0.120 (3.048) x 0.015 (0.381)
FPC06075	Directional Coupler 10 dB	12.0-18.0	0.100 (2.54) x 0.080 (2.032) x 0.015 (0.381)
FPC06151	Directional Coupler 10 dB	12.0-18.0	0.100 (2.54) x 0.080 (2.032) x 0.015 (0.381)
FPC06078	Directional Coupler 20 dB	12.0-18.0	0.100 (2.54) x 0.080 (2.032) x 0.015 (0.381)
FPC06164	Directional Coupler 20 dB	12.0-18.0	0.100 (2.54) x 0.080 (2.032) x 0.015 (0.381)

## KA BAND

PART NUMBER	TYPE	FREQUENCY RANGE, GHz	SIZE L X W X H, INCHES (mm)
B289KA0S	Bandpass Filter Uplink	28.6-29.1	0.550 (13.97) x 0.140 (3.556) x 0.088 (2.235)
B291MB0S	Bandpass Filter Uplink	3.0-10.0	0.450 (11.43) x 0.140 (3.556) x 0.088 (2.235)
B305LA0S	Bandpass Filter Uplink	3.5-10.0	0.550 (13.97) x 0.140 (3.556) x 0.078 (1.981)
PDW06984	Power Divider 2:1 Splitter	25.0-32.0	0.085 (2.159) x 0.095 (2.413) x 0.010 (0.254)
PDW07069	Power Divider 4:1 Splitter	24.0-32.0	0.140 (3.556) x 0.170 (4.318) x 0.010 (0.254)
PDW07630	Power Divider 2:1 Splitter	25.0-32.0	0.070 (1.778) x 0.070 (1.778) x 0.010 (0.254)
FPC07182	Directional Coupler 10 dB	20.0-40.0	0.065 (1.651) x 0.050 (1.27) x 0.010 (0.254)
FPC07181	Directional Coupler 20 dB	20.0-40.0	0.065 (1.651) x 0.050 (1.27) x 0.010 (0.254)

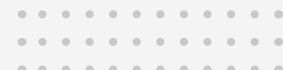



# User Guidelines: Chip and Wire or Hybrid Assembly

Some DLI brand parts are configured for chip and wire or hybrid assembly. This design enables a channelized assembly for parts recessed into boards. These filters will have a product code ending in “W”.

## TYPICAL IMPLEMENTATION (REFER TO FIGURES)

- PCB design includes a cavity to allow the filter to be recessed
- Filter is attached to system ground plane using conductive epoxy
- Wire or ribbon bonds form RF connection from filter to PCB
- An optimal design will include a cover to protect RF performance
- CTE mismatch between the ceramic circuit and housing should be minimized

## TERMINATION FINISH

Gold (100-200  $\mu$  inches)

## SHIELDING

Recommended to protect RF performance, especially above 18GHz.

Covers can be requested, DLI engineering will make recommendations based on layout

## MATERIAL RECOMMENDATIONS

- Conductive adhesive for the ground plane
- Wire or ribbon bonds for the I/Os

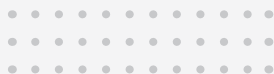
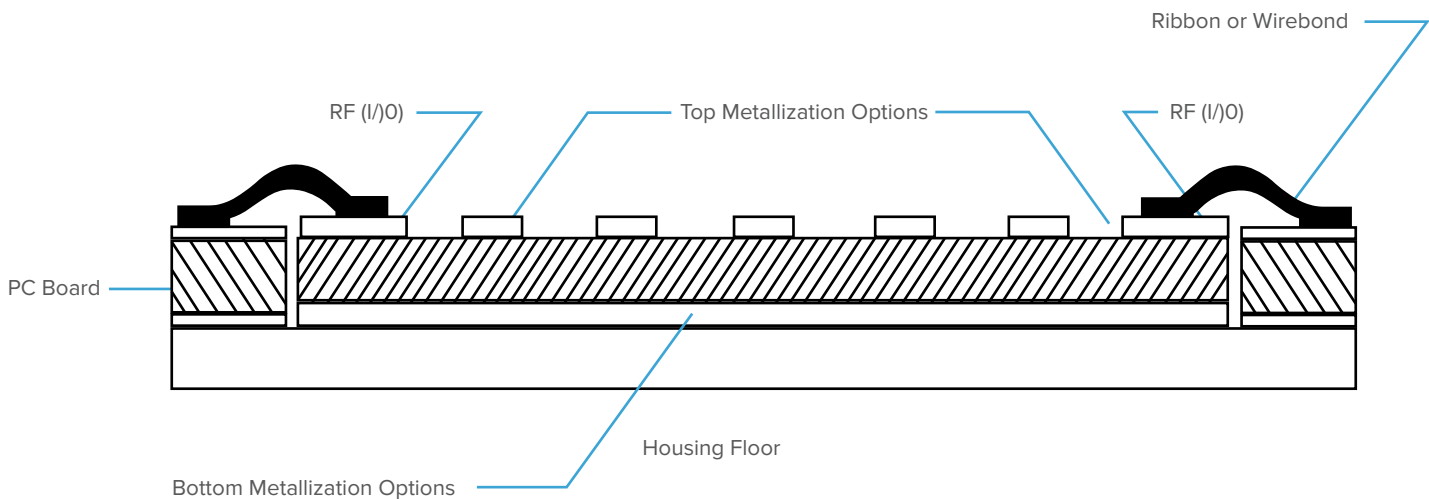

# User Guidelines: Surface Mount

## SURFACE MOUNT DEVICES (SMD) FOR SOLDER ATTACH

Many DLI brand parts are designed for solder attachment. This enables high volume production environments to assemble these parts just like any others in an automated surface mount line, with flexibility for low volume assembly as well. SMD filters will have a product code ending in “S”.

- Termination finish: ENIG, a solderable Ni layer covered with 3-6  $\mu$  inches of Gold unless otherwise stated
- Shielding: All SMD filters have an integrated RF shielded cover
- PCB layout recommendations are shown in this Figure

## ASSEMBLY RECOMMENDATIONS

- Performance is designed considering 2-3 mils finished solder standoff between the board and part once assembled
- Excess solder risks flowing up vias to invade the inside of the part, which will impact RF performance
- Stencil apertures should be designed with reduced area
- Preferred patterns avoid depositing solder paste over vias
- Solder is not intended to fill the castellation. Solder wetting will form a fillet; around 70% of the height of the castellation is acceptable
- It is recommended to use a profile as recommended by your solder material supplier

## SOLDER MATERIAL RECOMMENDATIONS

Solder may be applied as a stencil printing paste, dispensed paste or hand soldered with cored wire. Contacting the ceramic substrate with a hot soldering iron may thermal shock the component, resulting in cracks. Reflow profiling should be conducted with a thermocouple nearby to ensure parts don't see excessively high temperatures.

Note: These parts may be reworked, but only at the risk of altering the intended RF performance.

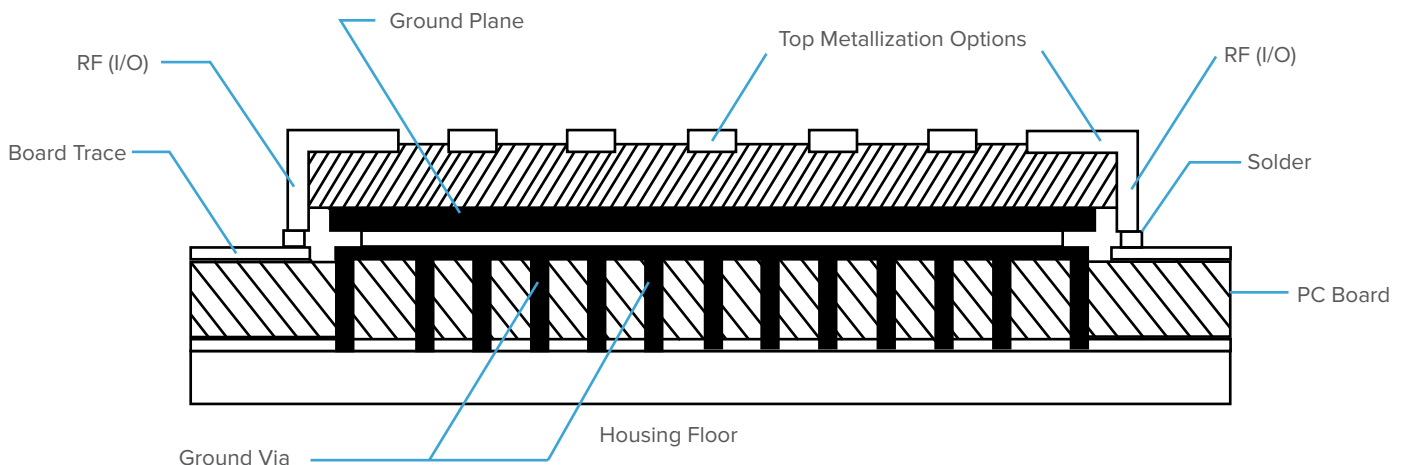

# Recommend Reflow for Surface Mount

## GENERAL REFLOW PROFILE RECOMMENDATIONS

Alloy Composition	Liquidus (°C)	Typical Peak Temp (°C)	Typical TAL (sec)	Typical Reflow Cycles
<b>Eutectic Tin-Lead</b>				
63Sn/37Pb	183	210 (max 230)	40-60 (max 90)	2
<b>Near-Eutectic Tin-Lead</b>				
62Sn/36Pb/2Ag	181	210 (max 230)	40-60 (max 90)	2
62.6Sn/37Pb/0.4Ag	182	210 (max 230)	40-60 (max 90)	2
60Sn/40Pb	191	220 (max 240)	40-60 (max 90)	2
<b>Near-Eutectic Pb-free</b>				
95.5Sn/3.8Ag/0.7Cu	220	240 (max 250)	30-60 (max 100)	2
96.5Sn/3Ag/0.5Cu	220	240 (max 250)	30-60 (max 100)	2
95.5Sn/4Ag/0.5Cu	225	245 (max 255)	30-60 (max 100)	2
98.5Sn/1Ag/0.5Cu	227	245 (max 255)	30-60 (max 100)	2

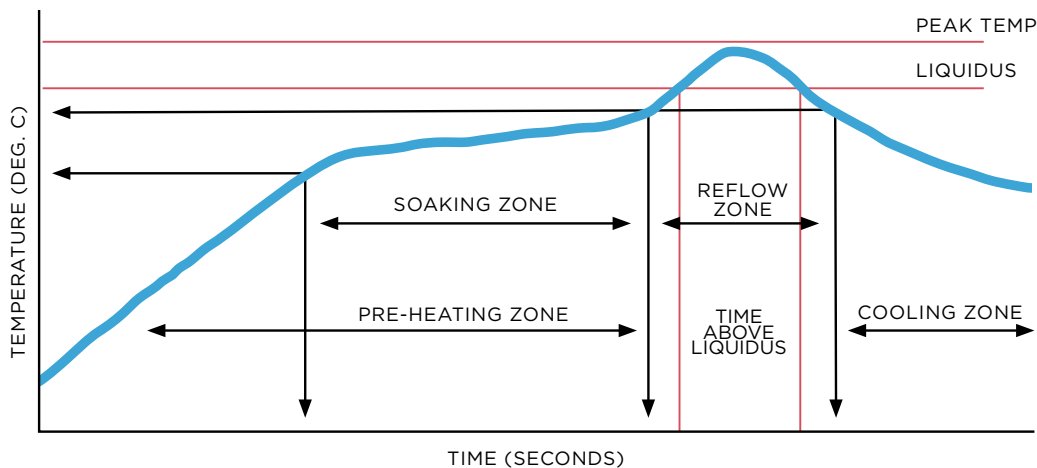

## COMMENTS ON SOLDER ATTACH AND COMPONENT HANDLING:

1. Contact of a soldering iron directly to the ceramic filter may crack component due to thermal shock.
2. If using a hot plate for reflow, do not place board and filter directly on plate. The use of an alumina or stainless-steel slab directly on the hot plate will slow the rate of heat hitting the mounting assembly.
3. Plastic tipped tweezers or a vacuum pick-up tool are recommended for handling the components. Extra care should be taken not to scratch the filter or metal pattern.
4. Solder paste is typically applied by stencil. Typical solder joint thickness of 2-3 mils is recommended. Plugged ground vias in the PWB will improve attachment consistency.
5. Thin, unmounted circuit boards are prone to warpage during reflow. This can cause solder attach defects and cracking of filters during handling or subsequent housing installation.



# RoHS Compliance Statement

Knowles Precision Devices is a leading supplier to the electronic components market and is fully committed to offering products supporting Restriction of Hazardous Substances (RoHS) directives. All our dielectric formulations are RoHS compliant along with a broad range of capacitors with RoHS compliant terminations. Knowles Precision Devices complies with the requirements of the individual customer and will maintain product offerings that meet industry demands.

## Quality and Environmental Policy

Knowles Precision Devices' reputation for quality and environmental responsibility is based on a commitment not only to meet customer requirements, but to exceed their expectations. The entire organization, beginning with top management, strives to achieve excellence in designing, manufacturing and delivering High Q capacitors and proprietary thin film components for niche high-frequency applications, while maintaining safe and healthy working conditions.

Furthermore, Knowles Precision Devices is committed to achieving these goals in an environmentally responsible manner through a commitment to comply with environmental regulations and pollution prevention initiatives. Knowles Precision Devices strives to continually improve the effectiveness of its quality and environmental management system through the establishment and monitoring of objectives and targets.



For more information, visit us online at [www.knowlescapacitors.com](http://www.knowlescapacitors.com)

051821/R10

## X-ON Electronics

Largest Supplier of Electrical and Electronic Components

*Click to view similar products for [Signal Conditioning](#) category:*

*Click to view products by [Knowles](#) manufacturer:*

Other Similar products are found below :

[MAPDCC0001](#) [MAPDCC0004](#) [PD0409J5050S2HF](#) [880157](#) [HHS-109-PIN](#) [DC1417J5005AHF](#) [AFS14A30-2185.00-T3](#) [AFS14A35-1591.50-T3](#) [DS-323-PIN](#) [B39321R801H210](#) [1A0220-3](#) [JP510S](#) [LFB212G45SG8C341](#) [LFB322G45SN1A504](#) [LFL182G45TC3B746](#) [SF2159E](#) [30057](#) [FM-104-PIN](#) [CER0813B](#) [MAPDCC0005](#) [3A325](#) [40287](#) [41180](#) [ATB3225-75032NCT](#) [BD0810N50100AHF](#) [BD2425J50200AHF](#) [C5060J5003AHF](#) [JHS-115-PIN](#) [JP503AS](#) [DC0710J5005AHF](#) [DC2327J5005AHF](#) [DC3338J5005AHF](#) [43020](#) [LFB2H2G60BB1C106](#) [LFL15869MTC1B787](#) [X3C19F1-20S](#) [XC3500P-20S](#) [10013-20](#) [SF2194E](#) [CDBLB455KCAX39-B0](#) [TGL2208-SM, EVAL](#) [RF1353C](#) [1E1305-3](#) [1F1304-3S](#) [1G1304-30](#) [B0922J7575AHF](#) [2020-6622-20](#) [TP-102-PIN](#) [TP-103-PIN](#) [BD1222J50200AHF](#)