

SLC Capacitors

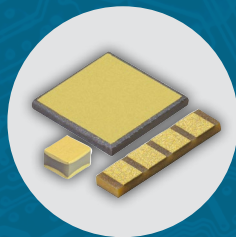

Introduction to Knowles Precision Devices

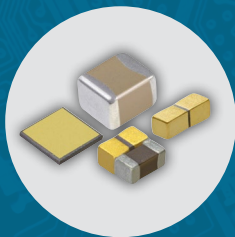
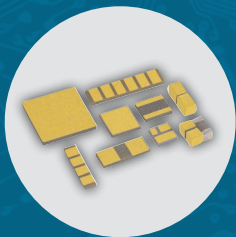
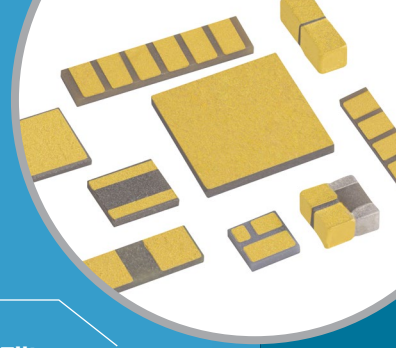

Knowles Precision Devices is a premier global source for Capacitors, RF Filters, EMI Filters, Resonators, non-magnetic components and advanced dielectric materials.

An umbrella for the brands of Compex, DLI, Johanson MFG, Novacap, Syfer and Voltronics, Knowles Precision Devices serves a variety of markets including: military, aerospace/avionics, medical equipment, implantable devices, EMI and connector filtering, oil exploration, instrumentation, industrial electronics, automotive, telecoms and data networks.

	Trimmer	Multilayer	High Reliability Capacitors	Single Layer Capacitors	RF & Microwave Products
Capacitors: AEC-Q200		●	●		
Capacitors: Broadband Blocks		●	●		
Capacitors: Cap Assemblies		●	●		
Capacitors: Detonation Pulse		●	●		
Capacitors: High Power		●	●		
Capacitors: High Q		●	●		
Capacitors: High Temperature		●	●		
Capacitors: High Voltage		●	●		
Capacitors: MLC - Leaded		●			
Capacitors: MLC - SMD		●	●		
Capacitors: Non-Magnetic	●	●	●		
Capacitors: Non-Magnetic Leaded	●	●			
Capacitors: Non-Magnetic Trimmers	●	●	●		
Capacitors: Planars and Discoidals			●		
Capacitors: Safety Certified		●	●		
Capacitors: Single Layer			●	●	
Capacitors: Trimmers	●	●			
Dielectric Substrates				●	
EMI Filters		●	●		
Non-Magnetic Hardware	●				
Non-Magnetic Inductors	●				
Microwave Couplers					●
Microwave Filters					●
Microwave Power Dividers					●
Microwave Resonators					●
Microwave Tuning Elements	●				●
RF: Gain Equalizers					●
RF: Bias Filter Networks					●
RF: Self Bias Networks					●
Thin Film: Build To Print					●
Heatsink/Standoff				●	
Mounting Shorts				●	

Table of Contents

INTRODUCTION

Simplified Frequency & Product Application Chart	4
--	---

SINGLE LAYER CAPACITORS DLI

SLC — Dielectric Information	5-6
SLC — Specifications	7
Packaging	8
V Series	9-10
Border Cap®	11-13
T-Cap®	14
Di-Cap®	15-17
Bar Cap®	18-19
Gap Cap®	20-22
Bi-Cap®	23-24

SINGLE LAYER CAPACITORS COMPLEX

Materials and Metallization	25
Typical Temperature Characteristics	26
CSA Series	27-29
CSM Series	30-32
CSB Series	33-34
CR/CM Series	35-37

SUBSTRATES & HEATSINKS DLI

High-K Ceramic Substrates & Plates	38-39
SLC — Heatsinks, Standoffs & Submounts	40-41

Substrates & Heatsinks Complex

SBT Series — Submounts	42
MST Series — Mounting Shorts	43

BROADBAND DEVICES DLI

Milli-Cap®	44-45
Opti-Cap®	46-47
PX Series	48-49
MLC — Broadband Blocks	50

RF COMPONENTS DLI

SLC — Gain Equalizers	51-52
Custom Thin Film: Integrated R-C Networks	53-54
Our Other Products	55

Simplified Frequency & Product Application Chart

■ DC Blocking
 ■ Low Noise Amplifiers
 ■ Power Amplifiers, High Power Amplifiers
 ■ Oscillators
 ■ Filters

SLC AND THIN FILM

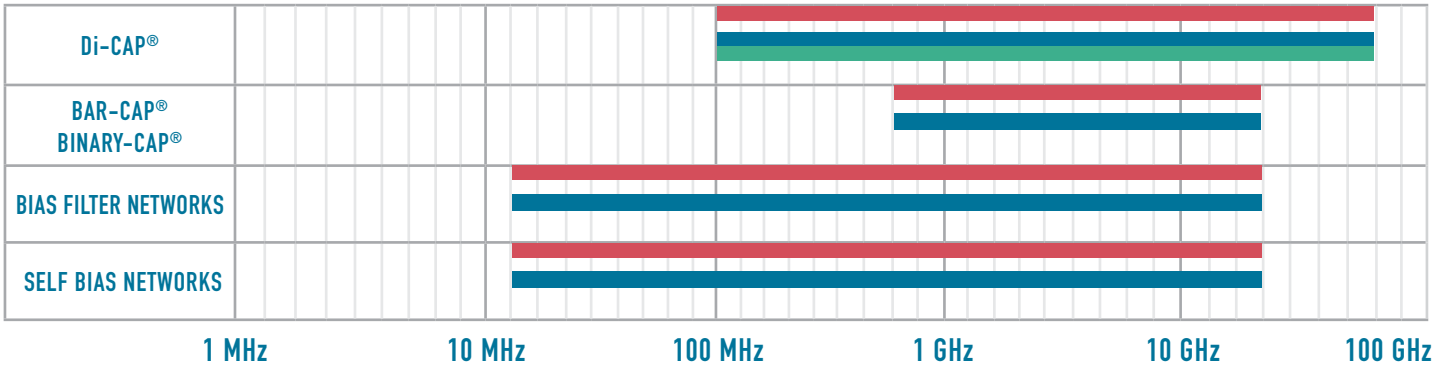

BROADBAND AND DC BLOCKS

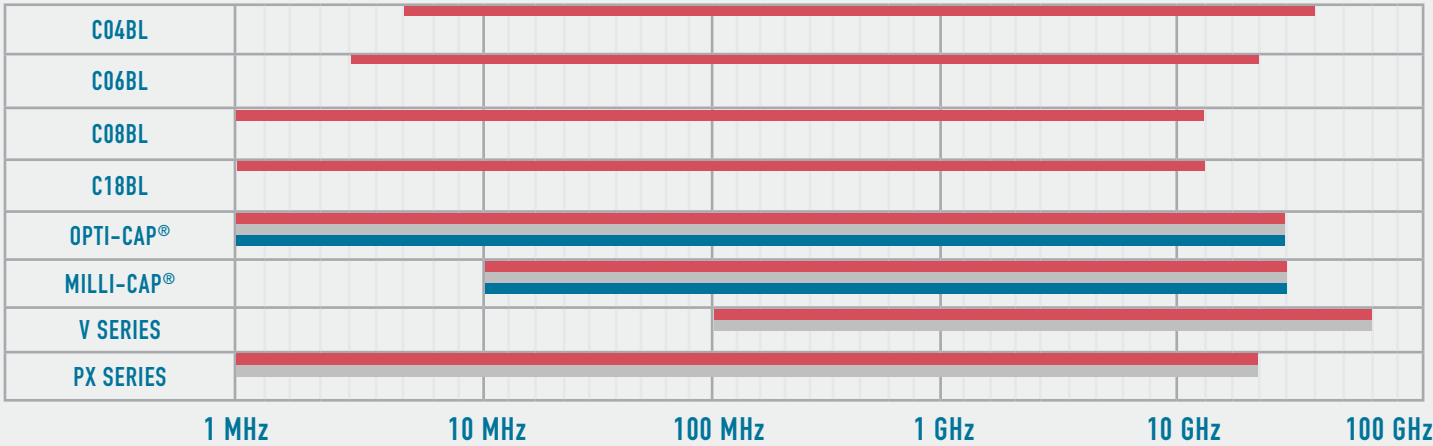

SLC — Dielectric Information

Single Layer Capacitors are available with any of our proprietary dielectric materials in the following configurations:

BORDER CAP®
Di-CAP®

BAR CAP®
Bi-CAP®

GAP CAP®
T-CAP®

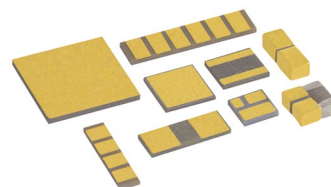

Please consult the following pages for part number identification

DLI CLASS I DIELECTRIC MATERIALS

Dielectric Code	Relative ϵ_r @ 1 MHz	Temperature Coefficient -55°C to 125°C (ppm/°C Max)	1 MHz Dissipation Factor (% Maximum)	25°C Insulation Resistance (M Ω)	125°C Insulation Resistance (M Ω)
PI	9.9	P105 \pm 20	0.15	>10 ⁶	>10 ⁵
PG	13	P22 \pm 30	0.15	>10 ⁶	>10 ⁵
AH	20	P90 \pm 20	0.15	>10 ⁶	>10 ⁵
CF	24	0 \pm 15	0.60	>10 ⁶	>10 ⁵
NA	22	N30 \pm 15	0.15	>10 ⁶	>10 ⁵
CD	37	N20 \pm 15	0.15	>10 ⁶	>10 ⁵
NG	43	N220 \pm 60	0.25	>10 ⁶	>10 ⁵
CG	70	0 \pm 30	0.70	>10 ⁶	>10 ⁵
DB	72	N50 \pm 30	0.15	>10 ⁶	>10 ⁵
NP	85	N750 \pm 200	0.50	>10 ⁴	>10 ³
NR	160	N1500 \pm 500	0.25	>10 ⁶	>10 ⁵
NS	300	N2400 \pm 500	0.70	>10 ⁶	>10 ⁵
NU	600	N3700 \pm 1000	1.50	>10 ⁶	>10 ⁵
NV	900	N4700 \pm 1000	1.20	>10 ⁶	>10 ⁵

DLI CLASS II DIELECTRIC MATERIALS

Dielectric Code	Relative ϵ_r @ 1 MHz	Temperature Coefficient -55°C to 125°C (ppm/°C Max)		1 MHz Dissipation Factor (% Maximum)	25°C Insulation Resistance (M Ω)	125°C Insulation Resistance (M Ω)
		No Bias, Pre Voltage Conditioning	No Bias, Pre Voltage Conditioning			
BF*	445	\pm 7.5	\pm 10	2.5	>10 ⁴	>10 ²
BD	700	\pm 10	\pm 15	2.5	>10 ⁴	>10 ³
BG*	900	\pm 10	\pm 15	2.5	>10 ⁴	>10 ³
BC	1300	\pm 10	\pm 15	2.5	>10 ⁴	>10 ³
BE	1250	\pm 10	\pm 15	2.5	>10 ⁴	>10 ³
BL	2000	\pm 15	\pm 25	2.5	>10 ⁵	>10 ⁴
BJ	3300	\pm 10	\pm 15	3.0	>10 ⁵	>10 ⁴
BN	4500	\pm 15	\pm 25	3.0	>10 ⁵	>10 ⁴
UX	25,000 - 35,000	\pm 15%	\pm 25%	2.5	>10 ³	>10 ²

DLI CLASS III DIELECTRIC MATERIALS

BT*	4200	+22, -56% (-55°C to 105°C)	+22, -56% (-55°C to 105°C)	3.0	>10 ⁵	>10 ²
BU	8500	+22, -82% (10°C to 85°C)	+22, -82% (10°C to 85°C)	3.0	>10 ⁵	>10 ⁴
BV	13,500	+22, -82% (10°C to 85°C)	+22, -82% (10°C to 85°C)	3.0	>10 ⁵	>10 ⁴

Note: * Recommended for commercial use only. Please contact an inside sales representative for additional information.



SLC — Dielectric Information

DIELECTRIC TEMPERATURE CHARACTERISTICS

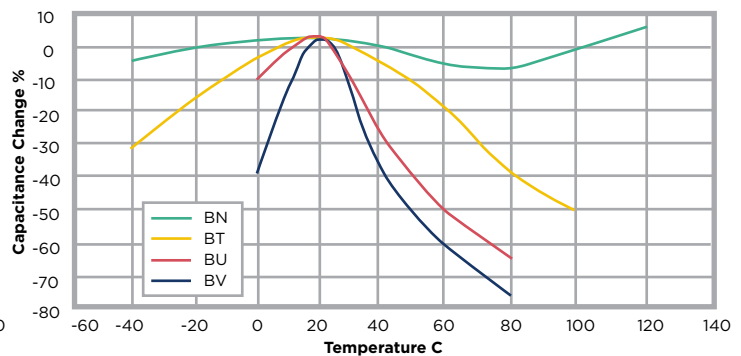
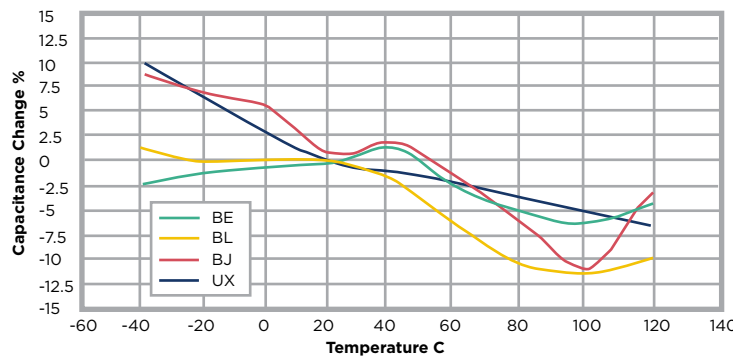
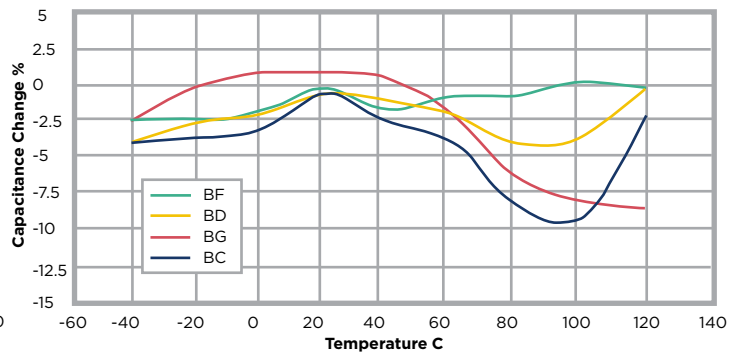
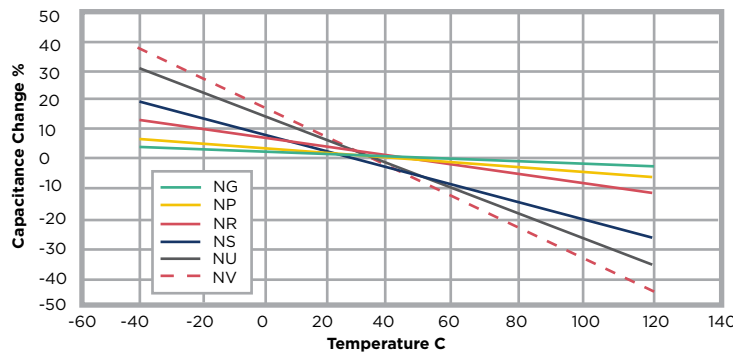
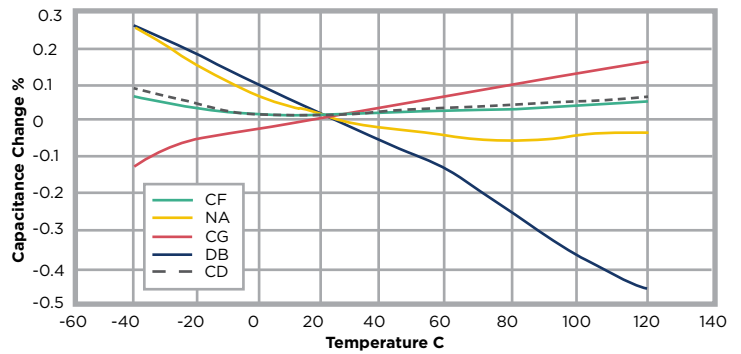
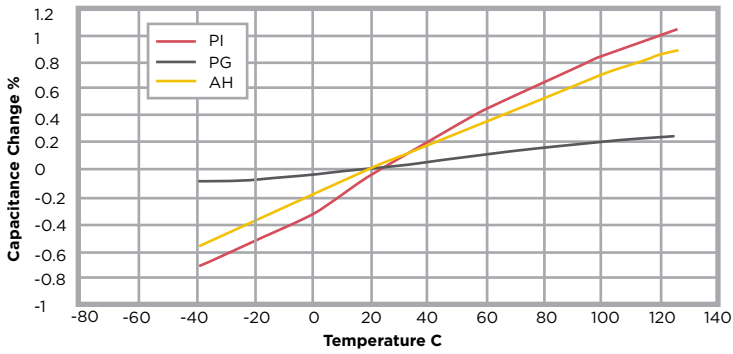

DIELECTRIC AGING CHARACTERISTICS

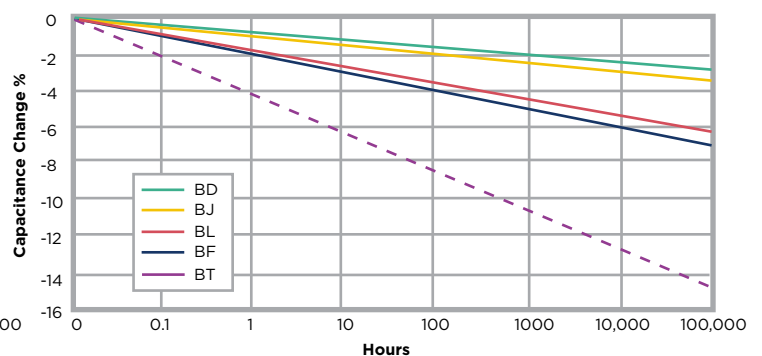
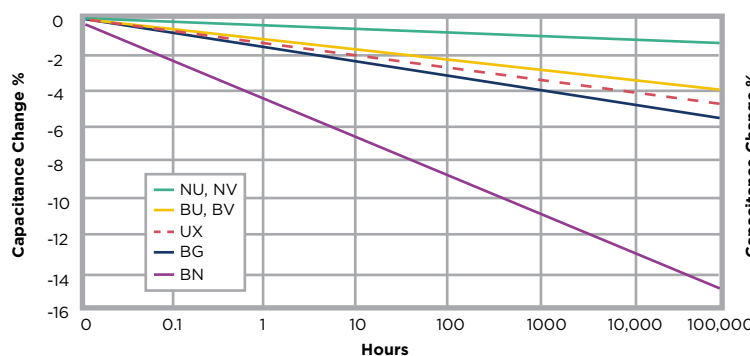

SLC — Specifications

TERMINATION CODES

Code	Description (Layers in order from dielectric material to outermost)	Capacitor Types	
 P	S1 (Sputter Plated) 1. 300 Angstroms Titanium-Tungsten 2. 50μ Inches min. Nickel-Vanadium 3. 100μ Inches min. Gold	AU-100 (Wet Plated) 1. 75μ Inches min. Nickel 2. 100μ Inches min. Gold	Di-Cap®, T-Cap®, Bar Cap®, Cinary Cap® and Gap Cap
 T	S2 1. 300 Angstroms Titanium-Tungsten 2. 50μ Inches min. Nickel-Vanadium 3. 100μ Inches min. Gold-Tin		Di-Cap® and T-Cap®
 M	S5 1. 300 Angstroms Titanium-Tungsten 2. 100μ Inches min. Gold		Di-Cap®, T-Cap®, Bar Cap®, Cinary Cap® and Gap Cap
 B	S1	AU-100	Single Border Cap
 E	S1	AU-100	Double Border Cap
 L	Standard lead material is silver (Ag) .002" thick. Optional Gold (Au)		Di-Cap®
 A	Standard lead material is Silver (Ag) .002" thick. Optional Gold (Au)		Di-Cap®
 Z	Standard lead material is Tin-Copper (Ag,Cu) .002" thick. Optional Gold (Au)		
 S	Standard lead material is silver (Ag) .002" thick. Optional Gold (Au)		Di-Cap®

Consult with engineering for solderable metal stacks

TEST LEVEL CODES

Code	Description
Industrial/Commercial Options	
X	<ul style="list-style-type: none"> 100% 4 Side Visual Screening 1% AQL for the electrical parameters Capacitance, Dissipation Factor, Insulation Resistance and Dielectric Withstanding Voltage
Industrial/Commercial Options	
A	MIL-PRF-49464 Group A <ul style="list-style-type: none"> 100% Thermal Shock 100%, 100 +0/-4 Hours Voltage Conditioning 100% Electrical Screening <ul style="list-style-type: none"> 100% 6 Side Visual Screening Bond Strength Die Shear Strength Temperature Coefficient Limits
B	MIL-PRF-49464 Group B <ul style="list-style-type: none"> MIL-PRF-49464, Group A Low Voltage Humidity <ul style="list-style-type: none"> Immersion Life
D	Special agreed upon testing to customers' formal specification. Customer Drawing Required! (May include, but is not limited to, one or more of the following common requests.) <ul style="list-style-type: none"> MIL-PRF-38534 Class H Element Evaluation. MIL-PRF-38534 Class K Element Evaluation. 10(0) Destructive Bond Pull per MIL-STD-883, Method 2011. 10(0) Die Shear per MIL-STD-883, Method 2019. Consult factory for other alternatives or assistance in specifying custom testing.
E	6 Side Visual Screening per MIL-STD-883, Method 2032.

CAPACITANCE TOLERANCE TABLE

Tolerance Code	Tolerance
A	±.05pF
B	±.010pF
C	±.25pF
D	±.50pF
E	±.5%
F	± 1%
G	± 2%
H	± 3%
I	± 4%
J	± 5%
K	± 10%
L	± 15%
M	± 20%
X	GMV
V	+100%, -0%
Z	+80%, -20%
S	Special

ENVIRONMENTAL & PHYSICAL TESTING PROCEDURES

Parameter	Method	MIL-STD-202 Condition
Thermal Shock	107	A, (modified), -55°C to +125°C
Immersion	104	B
Moisture Resistance	106	-
Resistance to Solder Heat	210	C, 260°C for 20 seconds
Life	108	A, 96 Hours @ +125°C.
Barometric Pressure	105	B
Shock, (Specified Pulse)	213	I, 100g's, 6ms.
Vibration, High Frequency	204	G, 30g's peak, 10Hz to 2kHz.

Parameter	Method	MIL-STD-202 Condition
Bond Strength	2011	D, 3 grams min. with .001 dia wire
Die Shear Strength	2019	Limit per MIL-STD-883, Figure 2019-4
Temperature Cycling	1010	C
Mechanical Shock	2002	B, Y1,
Constant Acceleration	2001	3,000g's Y1 direction

All Single Layer Capacitors are Lead Free (except Leaded Capacitors) and RoHS compliant.

SLC — Packaging

SLC WAFFLE PACKAGING

DLI offers a wide variety of standard design waffle packs in various materials depending on the application. Typical material offerings are antistatic and gel pack, which can contain up to 400 pieces depending on component dimension. Custom waffle packs are available; please consult the factory for details.

SLC TAPE AND REEL

DLI offers tape and reel packaging solutions for a variety of our single layer capacitor case sizes. Utilizing the latest technology and equipment to provide our customers the highest quality products, our standard SMD tape and reel packaging meets or exceeds EIA standards. Custom tape and reel packaging are available; consult the factory for options.

SLC ON TAPE RING

DLI offers single layer capacitors repopulated on blue membrane tape and photon ring assembly to maximize efficiency and minimize product cost. Used in high volume applications, the repopulated capacitors provide for more efficient component placement and fewer "pick and place" machine change-outs. The repopulated capacitors meet GMV capacitance value, are 100% visually acceptable and can be repopulated in custom shapes and sizes on a 6-inch photon tape ring.

SLC "BLACK DOTTED" ON TAPE RING

DLI offers "black dotted" capacitors on membrane tape and photon ring assembly. For high volume applications utilizing visual recognition, a less expensive alternative is the use of "black dotted" capacitors provided on saw dice membrane tape. The non- "black dotted" capacitors meet GMV capacitance value and a minimum of 75% visually acceptable product is guaranteed.

STORAGE

Single layer ceramic capacitors are solderable for a minimum of 1 year from date of shipment if properly stored in their original packaging. For extended periods, storage in a dry nitrogen environment is recommended. Product supplied on membrane tape and photon ring should be stored in the original container and in an environmentally controlled area where temperature and humidity are maintained. It is recommended not to store the product in direct light as this can negatively impact the adhesion properties of the tape.

HANDLING

Single layer ceramic capacitors should be handled carefully during component transfer or placement, preventing damage to the gold and ceramic surfaces. The capacitors should be handled with precision stainless steel tweezers or a vacuum wand. Contacting the capacitor with bare hands should be avoided as resulting contaminants will affect the performance of the component.

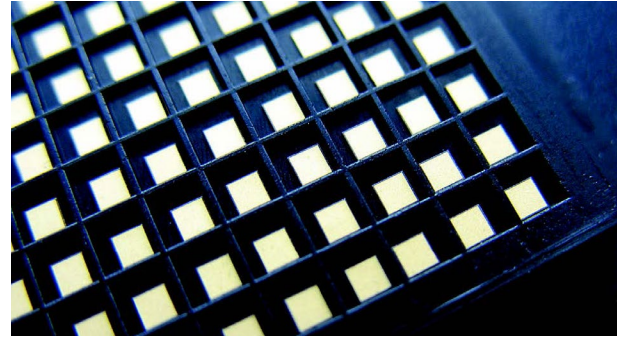

SLC Waffle Packaging

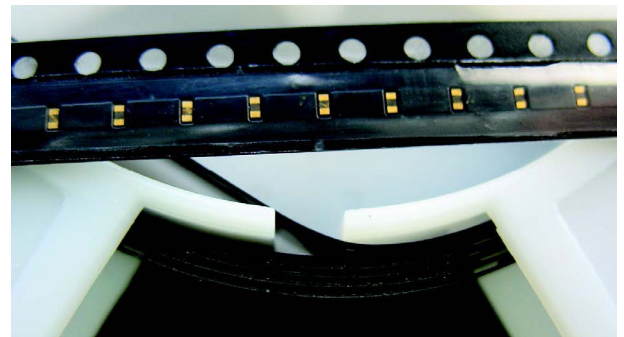

SLC Tape and Reel

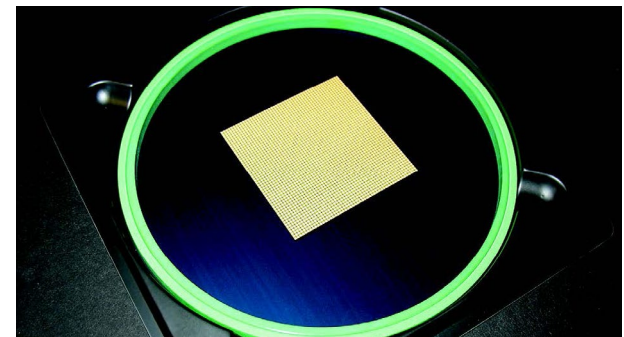

SLC on Tape Ring

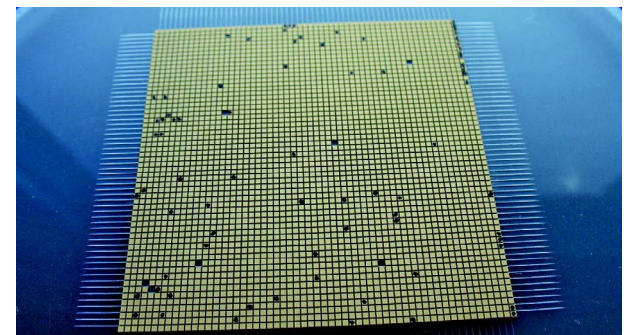

SLC — V Series

DESCRIPTION

Class II dielectric material with X7R characteristics for DC Blocking or RF Bypass applications in a broad frequency range.

These high frequency, wire bondable single layer capacitors are perfect for GaN and GaAs amplifier applications where small size and microwave performance is key to a well-performing circuit.

- X7R Temperature Stability
- Excellent High Frequency Response
- Wire Bondable
- RoHS Compliant
- High Capacitance in a Small Footprint
- MSL-1
- Rated Operating/Storage Temp. -55 to +125°C

FUNCTIONAL APPLICATIONS

- DC Blocking
- RF Bypassing
- Filtering
- Tuning and Coupling



Part Number	Capacitance	Voltage	Dissipation Factor @ 1MHz	Insulation Resistance @ +25C	Insulation Resistance @ +125C
V30BZ102M6SX	1nF ± 20%	200WVDC	2.5%	10 ³ MΩ	10 ² MΩ
V30BZ222M8SX	2.2nF ± 20%	150WVDC	2.5%	10 ³ MΩ	10 ² MΩ
V30BZ472M1SX	4.7nF ± 20%	100WVDC	2.5%	10 ³ MΩ	10 ² MΩ
V30BZ682M1SX	6.8nF ± 20%	100WVDC	2.5%	10 ³ MΩ	10 ² MΩ
V30BZ103M1SX	10nF ± 20%	100WVDC	2.5%	10 ³ MΩ	10 ² MΩ
V80BZ104M5SX	100nF ± 20%	50WVDC	2.5%	10 ³ MΩ	10 ² MΩ

Metal thickness is min. 100U" of Au over min. 50U" of Ni

Part Number	Length	Width	Thickness
V30BZ102M6SX	0.030" ± 0.003" (0.762mm ± 0.076mm)	0.030" ± 0.003" (0.762mm ± 0.076mm)	0.022" ± 0.003" (0.559mm ± 0.0762mm)
V30BZ222M8SX			
V30BZ472M1SX			
V30BZ682M1SX			
V30BZ103M1SX			
V80BZ104M5SX	0.084" ± 0.004" (2.134" mm ± 0.102")	0.042" ± 0.004" (1.067" mm ± 0.102")	0.024" ± 0.003" (0.610" mm ± 0.076")

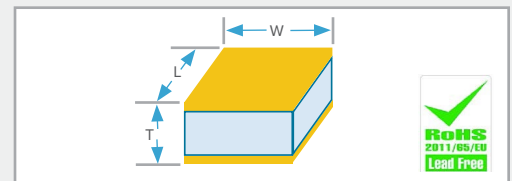

ORDERING INFORMATION — SLC — V SERIES CAPACITORS

V	30	BZ	102	M	5	S	X	
Product	Case Size	Material	Capacitance (pF)	Tolerance	Voltage	Termination	Test Level	Packaging
V = V Series	30 80	See material tables on Page 5.	102 = 1nF 222 = 2.2nF 472 = 4.7nF 682 = 6.8nF 103 = 10nF 104 = 100nF	M = ± 20%	5 = 50V 1 = 100V 6 = 200V 8 = 150V	S = Au / Ni	X = Commercial A = Group A B = Group B See test level definitions on page 7.	Available in Waffle Packs.



SLC — V Series

PERFORMANCE CHARACTERISTICS — V SERIES CAPACITORS

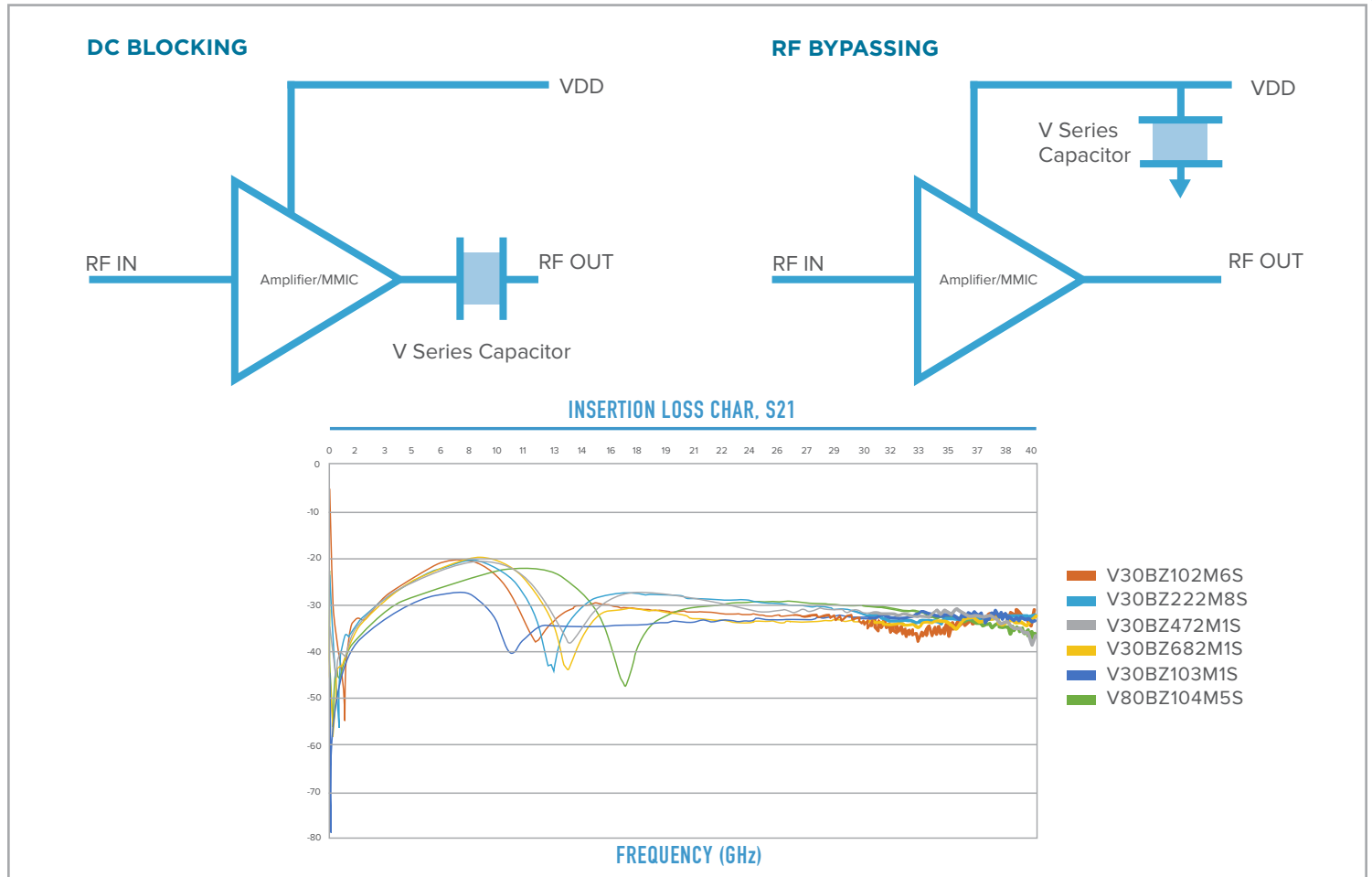

PERFORMANCE CHARACTERISTICS — V SERIES CAPACITORS

RECOMMENDED ATTACHMENT METHOD (CONDUCTIVE EPOXY) ALTERNATIVE ATTACHMENT METHOD (GOLD EUTECTIC)

Bonding can be done with either needle or automatic dispensers.

Epoxy curing defer to the epoxy manufacturer's preferred schedule but typically in the 125°C to 150°C range. Benefits of epoxy include easier repairs, cure doesn't need to be started immediately so multiple substrates may be processed at one time and epoxy is effective in higher frequencies.

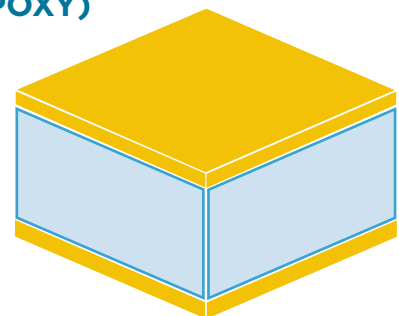

SLC — Border Cap®

DESCRIPTION

SLC with recessed metallization, available with borders on one or both sides.

Recessed metallization has been designed to minimize the potential of shorting during attachment (epoxy or solder).

- Available from 0.03pF to 2400pF
- Operating frequency up to 100GHz
- Wire Bondable
- 25, 50 and 100 Volt options
- Customized designs are available, please contact sales office

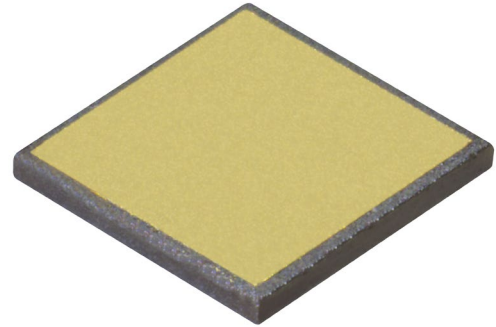

FUNCTIONAL APPLICATIONS

- DC Blocking
- RF Bypass
- Filtering
- Tuning and Coupling

TEST LEVEL CODES

Commercial Level	
X	100% 4-Side Visual 1% AQL Electrical (CAP/DF/IR & DWV)

HIGH RELIABILITY

A	MIL-PRF-49464 Group A	B	MIL-PRF-49464 Group B
	<ul style="list-style-type: none"> • 100% Thermal Shock • 100% Voltage Conditioning • 100% Electrical (CAP/DF/IR & DWV) • 100% 6-Side Visual • Bond Strength • Die Shear • Temperature Coefficient 		<ul style="list-style-type: none"> • MIL-PRF-49464 Group A • Immersion • Low Voltage Humidity • Life
		D	• Customer Defined
		E	• 6-Side Visual

VOLTAGE

Code	Voltage
2	25 Volts
5	50 Volts
1	100 Volts

CONFIGURATION

Code	Description
B	Single-Sided
E	Double-Sided

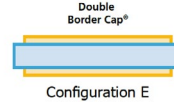
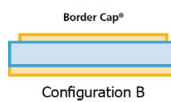

TOLERANCE

Code	Description
P	± 0.01pF
A	± 0.05pF
B	± 0.1pF
C	± 0.25pF
D	± 0.50pF
K	± 10%
L	± 15%
M	± 20%
X	GMV (Guarantee Minimum Value)
Z	+80%, -20%

Border Caps need to have a tolerance that is effectively 10%.

ORDERING INFORMATION — SLC — BORDER CAP®

D	10	BN	100	K	1	E	X	
Product	Case Size	Material	Capacitance (pF)	Tolerance	Voltage	Termination	Test Level	Packaging
D = Border Cap®	10 12 15 20 25 30 35 40 50	See material tables on Page 5.	R02 = 0.02 pF OR5 = 0.5 pF 1R0 = 1.0 pF 5R1 = 51 pF 100 = 10 pF 101 = 100 pF 152 = 1500 pF	A = ± 0.05pF B = ± 0.10pF C = ± 0.25pF D = ± 0.5pF F = ± 1% G = ± 2% J = ± 5% K = ± 10% L = ± 15% M = ± 20% Z = +80% -20%	2 = 25V* 5 = 50V *For Capacitors with UX material only	B = Single Border E = Double Border	X A B D E See test level definitions on page 7.	B = Black Dotted E = Repopulated T = Tape and Reel Leave blank for generic waffle pack. See packaging definitions on Page 8.
			Refer to Capacitance range tables for available values. Consult an inside sales rep for custom solutions.					

SLC — Border Cap®

DIMENSIONS

STYLE	LENGTH/WIDTH	PAD SIZE	BORDER	THICKNESS
D10	0.010" ± 0.001" (0.254mm ± 0.025mm)	0.008" (0.203mm)	0.001" (0.025mm)	0.006" ± 0.0025" (0.152mm ± 0.064mm)
D12	0.012" ± 0.001" (0.305mm ± 0.025mm)	0.010" (0.254mm)	0.001" (0.025mm)	0.006" ± 0.0025" (0.152mm ± 0.064mm)
D15	0.015" ± 0.001" (0.381mm ± 0.025mm)	0.011" (0.279mm)	0.002" (0.051mm)	0.006" ± 0.0025" (0.152mm ± 0.064mm)
D20	0.020" ± 0.001" (0.508mm ± 0.025mm)	0.016" (0.406mm)	0.002" (0.051mm)	0.006" ± 0.0025" (0.152mm ± 0.064mm)
D25	0.025" ± 0.001" (0.635mm ± 0.025mm)	0.021" (0.533mm)	0.002" (0.051mm)	0.006" ± 0.0025" (0.152mm ± 0.064mm)
D30	0.030" ± 0.001" (0.762mm ± 0.025mm)	0.026" (0.660mm)	0.002" (0.051mm)	0.006" ± 0.0025" (0.152mm ± 0.064mm)
D35	0.035" ± 0.001" (0.889mm ± 0.025mm)	0.031" (0.787mm)	0.002" (0.051mm)	0.006" ± 0.0025" (0.152mm ± 0.064mm)
D40	0.040" ± 0.001" (1.016mm ± 0.025mm)	0.036" (0.914mm)	0.002" (0.051mm)	0.006" ± 0.0025" (0.152mm ± 0.064mm)
D50	0.050" ± 0.001" (1.27mm ± 0.025mm)	0.046" (1.168mm)	0.002" (0.051mm)	0.006" ± 0.0025" (0.152mm ± 0.064mm)

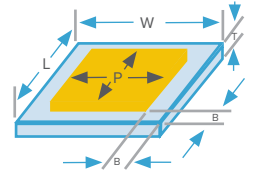

*UX material available in 25V (0.006" Thick) and 50V (0.010" Thick)

CAPACITANCE VALUES — SINGLE-SIDED

STYLE	D10		D12		D15		D20		D25		D30		D35		D40		D50										
CAPACITANCE (pF)																											
MATERIAL	MIN.	MAX.	TOL.	MIN.	MAX.	TOL.	MIN.	MAX.	TOL.	MIN.	MAX.	TOL.	MIN.	MAX.	TOL.	MIN.	MAX.	TOL.									
PI	0.03	0.05	P,K	0.05	0.07	P,K	0.06	0.09	P,K	0.15	0.15	A,K	0.2	0.3	A,K	0.3	0.45	A,K	0.35	0.6	A,B,K	0.5	0.7	A,B,K	0.8	1.1	B,K
PG	0.04	0.06	P,K	0.06	0.09	P,K	0.08	0.1	P,K	0.15	0.2	A,K	0.25	0.4	A,K	0.35	0.55	A,K	0.5	0.8	A,B,K	0.65	0.95	B,K	1	1.5	B,K
AH	0.06	0.1	P,K	0.09	0.1	P,K	0.15	0.2	A,K	0.25	0.35	A,K	0.4	0.6	A,K	0.55	0.9	B,K	0.75	1.2	B,K	1	1.4	B,K	1.5	2.2	K
CF	0.07	0.1	P,K	0.1	0.15	P,K	0.15	0.2	A,K	0.25	0.45	A,K	0.45	0.7	B,K	0.65	1	B,K	0.8	1.3	B,K	1.1	1.6	K	1.7	2.4	K
NA	0.07	0.1	P,K	0.15	0.15	A,K	0.15	0.2	A,K	0.25	0.45	A,K	0.45	0.7	B,K	0.65	1	B,K	0.85	1.5	B,K	1.2	1.7	K	1.8	2.7	K
CD	0.15	0.15	A,K	0.2	0.25	A,K	0.25	0.35	A,K	0.45	0.7	B,K	0.7	1.1	B,K	0.95	1.6	C,K	1.4	2.2	C,K	1.8	2.7	K	2.7	4.3	K
CG	0.25	0.35	A,K	0.3	0.5	A,K	0.45	0.7	B,K	0.8	1.3	C,K	1.3	2	C,K	1.8	3	D,K	2.7	4.3	D,K	3.3	5.1	K	5.1	8.2	K
DB	0.25	0.35	A,K	0.35	0.5	A,K	0.45	0.7	B,K	0.8	1.3	C,K	1.3	2.2	C,K	1.9	3	D,K	2.7	4.3	D,K	3.6	5.1	K	5.6	8.2	K
NP	0.25	0.4	A,K	0.4	0.6	B,K	0.55	0.85	B,K	0.95	1.6	C,K	1.5	2.4	C,K	2.2	3.6	D,K	3	5.1	D,K	4.3	6.2	K	6.2	10	K
NR	0.5	0.8	B,K	0.7	1.1	B,K	1	1.6	C,K	1.8	3	D,K	3	4.7	D,K	4.3	6.8	K	6.2	10	K	7.5	11	K	12	18	K
NS	0.9	1.5	C,K	1.3	2.2	C,K	1.9	3	D,K	3.6	5.6	D,K	5.6	9.1	K	8.2	13	K	11	18	K	15	22	K	22	33	K
NU	1.8	3	D,K	2.7	4.3	D,K	3.9	5.6	K	6.8	11	K	11	18	K	16	27	K	22	36	K	30	43	K	47	68	K
NV	2.7	4.3	D,K	3.9	6.2	K	5.6	8.2	D,K	10	16	K	16	27	K	24	39	K	33	56	K	43	62	K	68	100	K
BD	2.2	3.3	K	3	5.1	K	4.3	6.8	K	8.2	13	K	13	20	K	18	30	K	27	43	K	33	51	K	51	82	K
BC	3.9	6.2	K	5.6	9.1	K	8.2	13	K	15	24	K	24	39	K	36	56	K	47	75	K	62	91	K	100	150	K
BE	3.6	6.2	K	5.6	9.1	K	8.2	12	K	15	22	K	24	36	K	33	56	K	47	75	K	62	91	K	91	130	K
BL	6.2	10	K,M	9.1	13	K,M	13	20	K,M	24	36	K,M	36	56	K,M	56	91	K,M	75	120	K,M	100	130	K,M	150	220	K,M
BJ	10	16	K	15	24	K	20	33	K	39	62	K	62	100	K	91	150	K	120	200	K	160	240	K	270	390	K
BN	13	22	K,M	20	33	K,M	30	43	K,M	51	82	K,M	82	130	K,M	120	200	K,M	160	270	K,M	220	330	K,M	330	510	K,M
BU	27	43	M	36	62	M	56	82	M	100	160	M	150	240	M	220	360	M	300	510	M	430	620	M	620	1000	M
BV	39	68	M	62	100	M	82	130	M	150	240	M	240	390	M	360	560	M	510	820	M	680	1000	M	1000	1500	M

UX MATERIAL CAPCITANCE TABLE (ALL VALUES M TOLERANCE ± 20%)

VOLTAGE	MIN.	MAX.	MIN.	MAX.	MIN.	MAX.	MIN.	MAX.	MIN.	MAX.	MIN.	MAX.	MIN.	MAX.	MIN.	MAX.	MIN.	MAX.
25V	82	100	120	140	160	200	300	370	490	590	710	860	1000	1200	1300	1600	2000	2400
50V	-	-	-	-	100	140	200	240	300	370	450	540	600	750	800	950	1300	1500



SLC — Border Cap®

CAPACITANCE VALUES — DOUBLE-SIDED

STYLE	D10			D12			D15			D20			D25			D30			D35			D40			D50		
MATERIAL	MIN.	MAX.	TOL.	MIN.	MAX.	TOL.	MIN.	MAX.	TOL.	MIN.	MAX.	TOL.	MIN.	MAX.	TOL.	MIN.	MAX.	TOL.	MIN.	MAX.	TOL.	MIN.	MAX.	TOL.	MIN.	MAX.	TOL.
PI	0.03	0.04	P,K	0.04	0.06	P,K	0.06	0.08	P,K	0.1	0.15	A,K	0.2	0.25	A,K	0.25	0.4	A,K	0.35	0.55	A,B,K	0.45	0.65	A,B,K	0.7	1.1	B,K
PG	0.04	0.06	P,K	0.06	0.08	P,K	0.07	0.1	P,K	0.15	0.2	A,K	0.25	0.35	A,K	0.35	0.5	A,K	0.45	0.7	A,B,K	0.6	0.9	B,K	0.95	1.4	B,K
AH	0.06	0.09	P,K	0.09	0.1	P,K	0.15	0.15	A,K	0.2	0.3	A,K	0.35	0.5	A,K	0.5	0.8	A,B,K	0.7	1.1	B,K	0.9	1.3	B,K	1.54	2.2	K
CF	0.07	0.1	P,K	0.1	0.15	A,K	0.15	0.15	A,K	0.25	0.35	A,K	0.4	0.65	B,K	0.6	0.95	B,K	0.8	1.3	B,K	1.1	1.6	K	1.7	2.4	K
NA	0.07	0.1	P,K	0.09	0.15	A,K	0.15	0.15	A,K	0.25	0.35	A,K	0.4	0.6	B,K	0.55	0.9	B,K	0.75	1.2	B,K	1	1.5	K	1.6	2.4	K
CD	0.15	0.15	A,K	0.15	0.25	A,K	0.2	0.3	A,K	0.4	0.6	B,K	0.6	1	B,K	0.9	1.5	C,K	1.3	2	C,K	1.7	2.4	K	2.7	3.9	K
CG	0.2	0.3	A,K	0.3	0.45	A,K	0.4	0.55	A,K	0.7	1.1	B,K	1.2	1.9	C,K	1.7	2.7	C,K	2.4	3.9	D,K	3.3	4.7	K	5.1	7.5	K
DB	0.25	0.35	A,K	0.35	0.5	A,K	0.5	0.7	B,K	0.9	1.3	C,K	1.4	2.1	C,K	2	3.1	D,K	2.8	4.3	D,K	3.6	5.6	K	5.6	9.1	K
NP	0.25	0.4	A,K	0.4	0.6	B,K	0.55	0.8	B,K	1	1.5	C,K	1.7	2.5	C,K	2.4	3.7	D,K	3.3	5.1	D,K	4.3	6.8	K	6.8	10	K
NR	0.45	0.7	B,K	0.65	1.1	B,K	0.85	1.3	C,K	1.6	2.4	C,K	2.7	4.3	D,K	3.9	6.2	D,K	5.6	9.1	K	7.5	11	K	12	16	K
NS	0.85	1.3	C,K	1.3	2	C,K	1.6	2.4	D,K	3	4.7	D,K	5.1	8.2	K	7.5	12	K	10	16	K	15	20	K	22	33	K
NU	1.7	2.7	D,K	2.7	3.9	D,K	3.3	4.7	K	6.2	9.1	K	10	16	K	15	24	K	20	33	K	27	39	K	43	62	K
NV	2.7	3.9	D,K	3.9	6.2	K	5.1	6.8	K	9.1	13	K	15	24	K	22	36	K	30	51	K	43	62	K	68	100	K
BD	2	3	K	3	4.7	K	3.9	5.6	K	7.5	11	K	12	18	K	18	27	K	24	39	K	33	47	K	51	75	K
BC	3.6	5.6	K	5.6	8.2	K	6.8	10	K	13	20	K	22	33	K	33	51	K	43	68	K	62	82	K	91	130	K
BE	3.6	6.2	K	5.1	8.2	K	6.8	10	K	13	20	K	22	33	K	30	51	K	43	68	K	56	82	K	91	130	K
BL	5.6	9.1	K,M	8.2	13	K,M	11	16	K,M	20	30	K,M	33	51	K,M	51	82	K,M	68	110	K,M	91	130	K,M	150	220	K,M
BJ	9.1	15	K	15	22	K	18	27	K	33	51	K	56	82	K	82	130	K	110	180	K	150	220	K	240	360	K
BN	13	20	K,M	20	30	K,M	24	36	K,M	47	68	K,M	75	120	K,M	110	180	K,M	150	240	K,M	200	300	K,M	330	470	K,M
BU	24	39	M	36	56	M	47	68	M	91	130	M	150	220	M	220	330	M	300	470	M	390	560	M	620	910	M
BV	39	62	M	56	91	M	75	110	M	150	220	M	220	360	M	330	510	M	470	750	M	620	910	M	1000	1500	M

UX MATERIAL CAPACITANCE TABLE (ALL VALUES M TOLERANCE ± 20%)

VOLTAGE	MIN.	MAX.	MIN.	MAX.	MIN.	MAX.	MIN.	MAX.	MIN.	MAX.	MIN.	MAX.	MIN.	MAX.	MIN.	MAX.	MIN.	MAX.
25V	75	91	110	130	140	170	270	320	440	540	650	800	900	1100	1200	1500	2000	2400
50V	-	-	-	-	91	110	170	210	280	340	410	500	560	700	750	900	1200	1500



SLC — T-Cap®

DESCRIPTION

High Performance Single Layer Capacitors for RF, Microwave and Millimeter Wave Applications.

- Wire Bondable: 100μ" Au with a Ni Barrier Layer
- Customized solutions available, please contact sales office

FUNCTIONAL APPLICATIONS

- DC Blocking
- RF Bypassing
- Filtering
- Tuning
- Insulation
- Submounts
- Stand-Offs

BENEFITS

- Dimensional consistency
- Gold metallization for wire bonding
- Rugged construction



TEST LEVEL CODES

Commercial Level

X	100% 4-Side Visual 1% AQL Electrical (CAP/DF/IR & DWV)
---	---

HIGH RELIABILITY

A	MIL-PRF-49464 Group A	B	MIL-PRF-49464 Group B
	<ul style="list-style-type: none"> • 100% Thermal Shock • 100% Voltage Conditioning • 100% Electrical (CAP/DF/IR & DWV) • 100% 6-Side Visual • Bond Strength • Die Shear • Temperature Coefficient 		<ul style="list-style-type: none"> • MIL-PRF-49464 Group A • Immersion • Low Voltage Humidity • Life
		D	• Customer Defined
		E	• 6-Side Visual

TEST LEVEL CODES

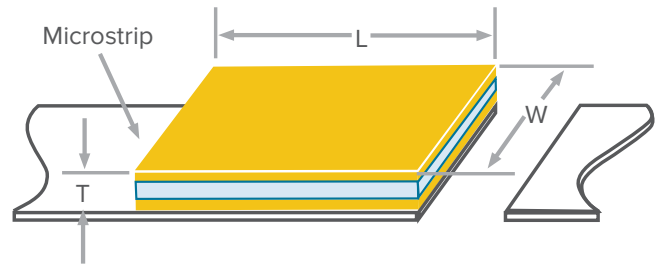

ORDERING INFORMATION — SLC — T-CAP®

T	30	BV	30	X	45	P	X	
Product	Width	Material	Length	Tolerance	Thickness	Termination	Test Level	Packaging
T = T-Cap®	Two digit number representing the Width in .001" For Widths >.099", Consult an inside sales rep.	See material tables on Page 5.	Two digit number representing the Length in .001" For Lengths >.099", Consult an inside sales rep.	X = Length & Width: ±.001", Thickness: -.0005" S = Special	35 – 99 Represents thickness in .0001" K0 = .010" M0 = .020" Examples: 55 = .0055" K2 = .012" M5 = .025"	P = Ni / Au T = Ni / AuSn M = Au	X See test level definitions on page 7.	T = Tape and Reel Leave blank for generic waffle pack. See packaging definitions on Page 8.



SLC — Di-Cap[®]

DESCRIPTION

High Performance Single Layer Capacitors for RF, Microwave and Millimeter Wave Applications.

- Available from 0.03pF to 10,000pF
- Operating frequency up to 100GHz
- Wire Bondable:
- Customized solutions are available, please contact sales office

FUNCTIONAL APPLICATIONS

- DC Blocking
- RF Bypassing
- Filtering
- Tuning and Coupling

BENEFITS

- ESD Proof
- Gold metallization for wire bonding
- Rugged construction

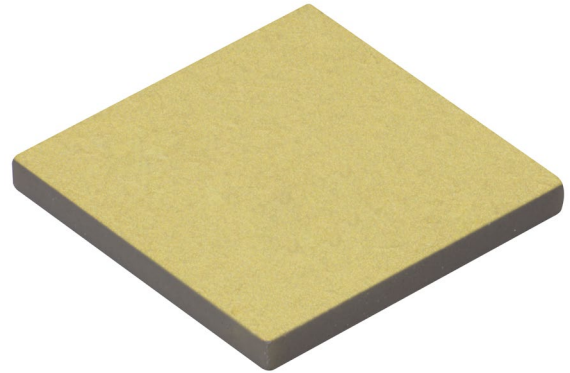

TEST LEVEL CODES

Commercial Level

X	100% 4-Side Visual 1% AQL Electrical (CAP/DF/IR & DWV)
---	---

VOLTAGE

Code	Voltage
2	25 Volts
5	50 Volts
1	100 Volts

TOLERANCE

Code	Description
P	± 0.01pF
A	± 0.05pF
B	± 0.1pF
C	± 0.25pF
D	± 0.50pF
K	± 10%
L	± 15%
M	± 20%
X	GMV (Guarantee Minimum Value)
Z	+80%, -20%

HIGH RELIABILITY

	MIL-PRF-49464 Group A	MIL-PRF-49464 Group B
A	<ul style="list-style-type: none"> • 100% Thermal Shock • 100% Voltage Conditioning • 100% Electrical (CAP/DF/IR & DWV) 	<ul style="list-style-type: none"> • 100% 6-Side Visual • Bond Strength • Die Shear • Temperature Coefficient
B	<ul style="list-style-type: none"> • MIL-PRF-49464 Group A • Immersion 	<ul style="list-style-type: none"> • Low Voltage Humidity • Life
D	<ul style="list-style-type: none"> • Customer Defined 	
E	<ul style="list-style-type: none"> • 6-Side Visual 	

ORDERING INFORMATION — SLC — Di-CAP[®]

D	10	CF	OR1	B	5	P	X	
Product	Case Size	Material	Capacitance (pF)	Tolerance	Voltage	Termination	Test Level	Packaging
D = Di-Cap [®]	10 12 15 20 25 30 35 50 70 90	See material tables on Page 5.	R02 = 0.02 pF OR5 = 0.5 pF 1R0 = 1.0 pF 5R1 = 5.1 pF 100 = 10 pF 101 = 100 pF 432 = 4,300 pF Refer to Capacitance range tables for available values. Consult an inside sales rep. for custom solutions.	A = ± 0.05pF B = ± 0.10pF C = ± 0.25pF D = ± 0.5pF F = ± 1% G = ± 2% J = ± 5% K = ± 10% L = ± 15% M = ± 20% Z = +80% -20%	2 = 25V 5 = 50V 1 = 100V	P = Ni/Au or TiW/NiV/Au T = TiW/NiV/Au-Sn M = TiW/Au L = Single Beam Lead A = Axial Beam Lead S = Standing Axial Beam Lead D = Special Z = Tin Copper Ribbon	X A B D E See test level definitions on page 7.	T = Tape and Reel Leave blank for generic waffle pack. See packaging definitions on Page 8.

Border Caps need to have a tolerance that is effectively 10%.

SLC — Di-Cap[®]

STYLE	LENGTH	WIDTH	THICKNESS	
			50 Volt	100 Volt
D10	0.010" MAX. (0.254mm MAX.)	0.010" + 0/-0.003" (0.254mm + 0/-0.076mm)	0.004" ± 0.001" (0.102mm ± 0.025mm)	-
D12	0.015" MAX. (0.381mm MAX.)	0.012" + 0.002"/-0.003" (0.305mm + 0.051mm/-0.076mm)	0.004" ± 0.001" (0.102mm ± 0.025mm)	-
D15	0.020" MAX. (0.508mm MAX.)	0.015" + 0/-0.003" (0.381mm + 0/-0.076mm)	0.004" ± 0.001" (0.102mm ± 0.025mm)	0.006" ± 0.001" (0.152mm ± 0.025mm)
D20	0.020" MAX. (0.508mm MAX.)	0.020" + 0/-0.003" (0.508mm + 0/-0.076mm)	0.004" ± 0.001" (0.102mm ± 0.025mm)	0.006" ± 0.001" (0.152mm ± 0.025mm)
D25	0.030" MAX. (0.762mm MAX.)	0.025" + 0/-0.003" (0.635mm + 0/-0.076mm)	0.004" ± 0.001" (0.102mm ± 0.025mm)	0.006" ± 0.001" (0.152mm ± 0.025mm)
D30	0.030" MAX. (0.762mm MAX.)	0.030" + 0/-0.003" (0.762mm + 0/-0.076mm)	0.004" ± 0.001" (0.102mm ± 0.025mm)	0.006" ± 0.001" (0.152mm ± 0.025mm)
D35	0.040" MAX. (1.016mm MAX.)	0.035" ± 0.005" (0.889mm ± 0.127mm)	0.004" ± 0.001" (0.102mm ± 0.025mm)	0.007" ± 0.002" (0.178mm ± 0.051mm)
D50	0.060" MAX. (1.524mm MAX.)	0.050" ± 0.010" (1.270mm ± 0.254mm)	-	0.007" ± 0.002" (0.178mm ± 0.051mm)
D70	0.080" MAX. (1.778mm MAX.)	0.070" ± 0.010" (1.778mm ± 0.254mm)	-	0.007" ± 0.002" (0.178mm ± 0.051mm)
D90	0.100" MAX. (2.54mm MAX.)	0.090" ± 0.010" (2.286mm ± 0.254mm)	-	0.007" ± 0.002" (0.178mm ± 0.051mm)

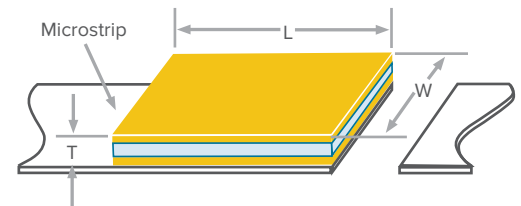

*UX material available in 25V (0.006" Thick) and 50V (0.010" Thick)

CAPACITANCE VALUES — 50 VOLT RATED Di-CAP[®]

STYLE	D10		D12		D15		D20		D25		D30		D35								
CAPACITANCE (pF)																					
MATERIAL	MIN.	MAX.	TOL.	MIN.	MAX.	TOL.	MIN.	MAX.	TOL.	MIN.	MAX.	TOL.	MIN.	MAX.	TOL.	MIN.	MAX.	TOL.	MIN.	MAX.	TOL.
PI	0.03	0.05	P	0.04	0.1	P	0.06	0.15	P,K	0.09	0.2	P,A	0.2	0.4	A,B	0.25	0.45	A,B	0.35	0.85	A,B
PG	0.04	0.06	P	0.06	0.1	P	0.08	0.2	P,A	0.15	0.25	P,A	0.25	0.5	A,B	0.3	0.6	A,B	0.5	1.1	A,B
AH	0.06	0.1	P	0.08	0.2	P,A	0.15	0.3	P,A	0.2	0.4	A,B	0.35	0.8	A,B	0.45	0.95	A,B	0.7	1.8	A,B,C
CF	0.07	0.1	P	0.1	0.25	P,A	0.15	0.35	P,A	0.2	0.5	P,A,B	0.45	0.95	A,B	0.55	1.1	A,B	0.85	2	A,B,C
NA	0.06	0.1	P	0.09	0.2	P,A	0.15	0.3	P,A	0.2	0.45	A,B	0.4	0.9	A,B	0.5	1	A,B	0.8	1.9	B,C
CD	0.1	0.15	P	0.15	0.35	P,A	0.25	0.55	A,B	0.35	0.75	A,B	0.65	1.5	A,B,C	0.85	1.8	B,C	1.3	3.3	B,C
CG	0.2	0.35	P,A	0.3	0.75	A,B	0.45	1.1	A,B	0.65	1.4	A,B,C	1.2	2.7	B,C	1.6	3.3	B,C	2.7	6.2	C,D
NP	0.25	0.4	A	0.35	0.9	A,B	0.5	1.3	A,B,C	0.75	1.8	B,C	1.5	3.3	C,D	1.9	3.9	C,D	3	7.5	C,D
NR	0.45	0.8	A,B	0.65	1.7	B,C	1	2.4	B,C	1.5	3.3	C,D	2.7	6.2	C,D,K	3.6	7.5	D	5.6	13	D,J,K
NS	0.8	1.5	B,C	1.2	3	B,C	1.8	4.7	C,D	2.7	6.2	C,D	5.1	12	K	6.8	13	K	11	27	K
NU	1.6	3	B,C	2.4	6.2	C,D	3.6	9.1	D,K	5.6	12	D,K	11	24	K	15	27	K	22	51	K
NV	2.4	4.3	C,D	3.6	9.1	D,K	5.6	13	D,K	8.2	18	K	16	36	K	20	43	K	33	75	K
BD	1.8	3.6	K	3	7.5	K	4.3	11	K	6.2	13	K	12	27	K	16	33	K	27	62	K
BC	3.6	6.2	K	5.1	13	K	7.5	20	K	12	27	K	22	51	K	30	62	K	47	110	K
BE	3.3	6.2	K	5.1	13	K	7.5	18	K	12	24	K	22	51	K	30	62	K	47	110	K
BL	5.6	10	K,M	8.2	20	K,M	12	30	K,M	24	39	K,M	36	82	K,M	47	91	K,M	75	180	K,M
BJ	9.1	16	K	13	33	K	20	51	K	30	68	K	56	130	K	75	160	K	120	270	K
BN	12	22	K,M	18	47	K,M	27	68	K,M	43	91	K,M	82	180	K,M	100	220	K,M	160	390	K,M
BU	22	43	M	36	91	M	51	130	M	75	180	M	150	330	M	200	390	M	300	750	M
BV	36	68	M	56	130	M	82	200	M	120	270	M	240	510	M	300	620	M	510	1200	M



SLC — Di-Cap®

CAPACITANCE VALUES — 100 VOLT RATED Di-CAP®

STYLE	D15			D20			D25			D30			D35			D50			D70			D90		
CAPACITANCE (pF)																								
MATERIAL	MIN.	MAX.	TOL.	MIN.	MAX.	TOL.	MIN.	MAX.	TOL.	MIN.	MAX.	TOL.	MIN.	MAX.	TOL.	MIN.	MAX.	TOL.	MIN.	MAX.	TOL.	MIN.	MAX.	TOL.
PI	0.04	0.1	P	0.06	0.1	P	0.15	0.25	P,A	0.15	0.3	P,A	0.2	0.55	A,B	0.5	1.3	A,B	0.95	2	B,C	1.2	3	B,C
PG	0.06	0.1	P	0.08	0.15	P	0.2	0.35	A	0.2	0.4	A,B	0.25	0.75	A,B	0.6	1.7	B,C	1.2	2.7	B,C	1.5	3.9	B,C
AH	0.08	0.2	P,A	0.15	0.25	P,A	0.25	0.5	A,B	0.35	0.65	A,B	0.4	1.2	A,B,C	0.95	2.7	B,C	1.9	3.9	B,C	2.4	6.2	C,D
CF	0.1	0.25	P,A	0.15	0.3	P,A	0.3	0.65	A,B	0.4	0.75	A,B	0.45	1.4	A,B,C	1.1	3	B,C	2.4	4.7	C,D	3	7.5	C,D
NA	0.09	0.2	P,A	0.15	0.3	P,A	0.3	0.5	A,B	0.35	0.7	A,B	0.45	1.3	A,B,C	1.1	3	B,C	2.2	4.3	C,D	2.7	6.8	C,D
CD	0.15	0.35	P,A	0.25	0.5	A,B	0.5	1	A,B	0.6	1.2	A,B,C	0.7	2.2	B,C	1.7	4.7	C,D	3.6	7.5	C,D	4.3	12	D,J,K
CG	0.3	0.7	A,B	0.45	0.95	A,B	0.95	1.9	A,B,C	1.1	2.2	B,C	1.3	3.9	B,C,D	3.3	9.1	C,D,K	6.8	13	D,K	8.2	22	J,K
DB	0.3	0.75	A,B	0.45	1	A,B	1	1.9	B,C	1.1	2.2	B,C	1.4	4.3	C,D	3.3	9.1	C,D,K	6.8	15	D,K	8.2	22	J,K
NP	0.35	0.85	A,B	0.55	1.2	B,C	1.2	2.2	B,C	1.3	2.7	B,C,D	1.6	5.1	C,D	3.9	11	C,D,K	8	16	J,K	10	27	J,K
NR	0.65	1.6	B,C	1	2.2	B,C	2.2	4.3	C,D	2.7	5.1	C,D	3	9.1	D,K	7.5	20	J,K	15	33	J,K	20	51	J,K
NS	1.2	3	C,D	1.9	3.9	C,D	3.9	8.2	D,K	4.7	9.1	D,K	5.6	18	K	15	39	K	30	62	K	36	91	K
NU	2.4	6.2	C,D	3.9	8.2	C,D,k	8.2	16	D,J,K	9.1	18	J,K	12	36	J,K	30	82	J,K	56	120	K	68	180	K
NV	3.6	9.1	D,K	5.6	12	D,K	12	24	K	15	27	K	18	51	K	43	120	K	91	180	K	100	270	K
BD	3	6.8	K	4.3	9	K	8	18	K	11	22	K	13	39	K	33	91	K	68	130	K	82	220	K
BC	5.6	13	K	8	18	K	16	33	K	20	43	K	24	160	K	62	160	K	120	270	K	150	390	K
BE	5.1	13	K	8	16	K	15	33	K	20	39	K	24	160	K	62	160	K	120	240	K	150	390	K
BL	8.2	20	K,M	13	27	K,M	24	51	K,M	33	62	K,M	39	270	K,M	100	270	K,M	200	390	K,M	240	620	K,M
BJ	13	33	K	20	47	K	38	82	K	51	100	K	62	430	K	160	430	K	330	680	K	390	1000	K
BN	18	47	K,M	30	62	K,M	56	120	K,M	68	130	K,M	91	560	K,M	220	560	K,M	430	910	K,M	510	1300	K,M
BU	36	82	M	56	120	M	100	220	M	130	270	M	160	1100	M	390	1100	M	820	1600	M	1000	2700	M
BV	56	130	M	82	180	M	160	360	M	220	430	M	270	1800	M	620	1800	M	1300	2700	M	1600	4300	M

UX MATERIAL CAPCITANCE TABLE

STYLE	D10		D12		D15		D20		D25		D30		D35		D50		D70		D90	
CAPACITANCE (pF)																				
MATERIAL	MIN.	MAX.	MIN.	MAX.	MIN.	MAX.	MIN.	MAX.	MIN.	MAX.	MIN.	MAX.	MIN.	MAX.	MIN.	MAX.	MIN.	MAX.	MIN.	MAX.
25V	51	75	75	180	110	250	170	340	280	650	390	800	620	1400	1600	3200	3500	5900	6200	10,000
50V	-	-	-	-	-	-	100	200	170	390	240	470	360	850	940	2000	2100	3500	3700	5500

SLC — Bar Cap®

DESCRIPTION

Multiple Decoupling/Blocking Capacitors in a Single Array.

- Operating frequency up to 30GHz
- Wire Bondable: 100μ" Au with a Ni Barrier Layer
- Customized solutions available, please contact sales office

FUNCTIONAL APPLICATIONS

- DC Blocking
- RF Bypassing
- Decoupling
- GaAs ICs

BENEFITS

- Single insertion reduces complexity and cost
- Gold metallization for wire bonding
- Reduce bond wires for improved performance

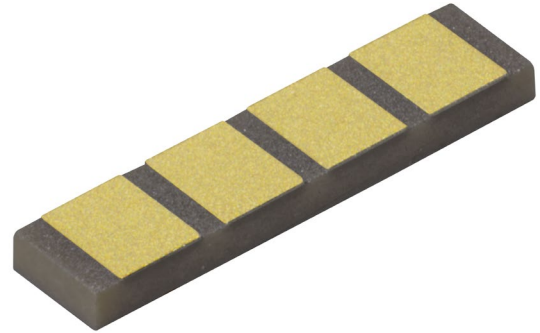

TEST LEVEL CODES

Commercial Level

X	100% 4-Side Visual 1% AQL Electrical (CAP/DF/IR & DWV)
---	---

HIGH RELIABILITY

A	MIL-PRF-49464 Group A	B	MIL-PRF-49464 Group B
	<ul style="list-style-type: none"> • 100% Thermal Shock • 100% Voltage Conditioning • 100% Electrical (CAP/DF/IR & DWV) • 100% 6-Side Visual • Bond Strength • Die Shear • Temperature Coefficient 		<ul style="list-style-type: none"> • MIL-PRF-49464 Group A • Immersion • Low Voltage Humidity • Life
		D	• Customer Defined
		E	• 6-Side Visual

TOLERANCE

Code	Description
Z	+80%, -20%

VOLTAGE

Code	Voltage
2	25 Volts
5	50 Volts
1	100 Volts

ORDERING INFORMATION — SLC — BAR CAP®

E	40	BU	151	Z	1	P	X	4	
Product	Case Size	Material	Capacitance (pF)	Tolerance	Voltage	Termination	Test Level	Capacitor Quantity (mils)	Packaging
E = Bar Cap®	20 25 30 40	See material tables on Page 5.	800 = 80 pF 101 = 101 pF 121 = 120 pF 151 = 150 pF Consult an inside sales rep for custom solutions.	Z = +80% -20%	2 = 25V 5 = 50V	P = Ni / Au M = Au	X See test level definitions on page 7.	3 4 6 Etc.	T = Tape and Reel Leave blank for generic waffle pack. See packaging definitions on Page 8.

*Custom Solutions are available; however, additional tooling costs may apply. Please contact the sales office for more information.

SLC — Bar Cap®

DIMENSIONS

Case Style	No. of Caps	Width	Length	Thickness	Pad Size
E20	3	0.020" ±0.003" (0.508mm ±0.076mm)	0.065" ±0.005" (1.651mm ±0.127mm)	See below	0.020" ±0.015" (0.508mm ±0.381mm)
	4		0.085" ±0.005" (2.159mm ±0.127mm)		
	6		0.125" ±0.005" (3.175mm ±0.127mm)		
E25	3	0.025" ±0.003" (0.635mm ±0.076mm)	0.065" ±0.005" (1.651mm ±0.127mm)	See below	0.025" ±0.015" (0.635mm ±0.381mm)
	4		0.085" ±0.005" (2.159mm ±0.127mm)		
	6		0.125" ±0.005" (3.175mm ±0.127mm)		
E30	3	0.030" ±0.003" (0.762mm ±0.076mm)	0.065" ±0.005" (1.651mm ±0.127mm)	See below	0.030" ±0.015" (0.762mm ±0.381mm)
	4		0.085" ±0.005" (2.159mm ±0.127mm)		
	6		0.125" ±0.005" (3.175mm ±0.127mm)		
E40	3	0.040" ±0.003" (1.016mm ±0.076mm)	0.065" ±0.005" (1.651mm ±0.127mm)	See below	0.040" ±0.015" 4 (1.016mm ±0.381mm)
	4		0.085" ±0.005" (2.159mm ±0.127mm)		
	6		0.125" ±0.005" (3.175mm ±0.127mm)		

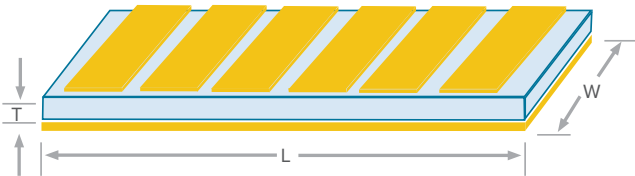

Voltage	Thickness
100 V	0.007" ± 0.001" (0.178mm ± 0.025mm)
25 V	0.006" ± 0.001" (0.152mm ± 0.025mm)
50 V	0.010" ± 0.001" (0.254mm ± 0.025mm)

CAPACITANCE VALUES — BAR GAP®

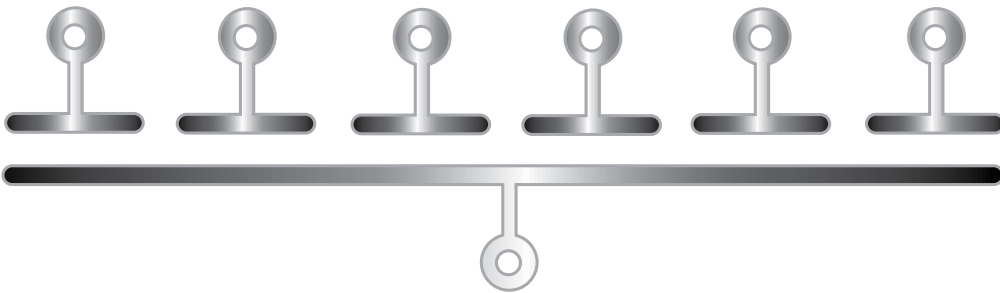

SLC — Gap Cap®

DESCRIPTION

Series Configured Capacitor for Microwave Applications. Recessed metallization has been designed to minimize the potential of shorting during attachment (epoxy or solder).

- Available from 0.2pF to 800pF
- Operating frequency up to 30GHz
- Customized solutions

FUNCTIONAL APPLICATIONS

- DC Blocking
- RF Bypassing
- Filtering
- Tuning
- Coupling

BENEFITS

- Eliminates wire bonding
- Coplanar waveguide
- Low insertion loss

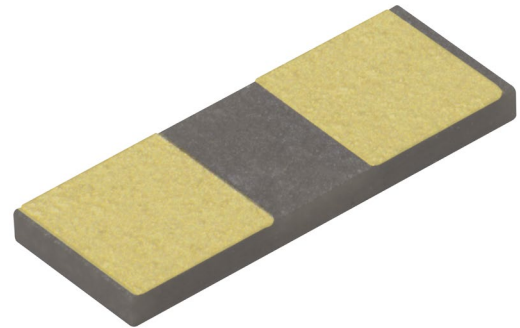

TEST LEVEL CODES

Commercial Level	
X	100% 4-Side Visual 1% AQL Electrical (CAP/DF/IR & DWV)

HIGH RELIABILITY

A	MIL-PRF-49464 Group A	B	MIL-PRF-49464 Group B
	<ul style="list-style-type: none"> • 100% Thermal Shock • 100% Voltage Conditioning • 100% Electrical (CAP/DF/IR & DWV) • 100% 6-Side Visual • Bond Strength • Die Shear • Temperature Coefficient 		<ul style="list-style-type: none"> • MIL-PRF-49464 Group A • Immersion • Low Voltage Humidity • Life
		D	• Customer Defined
		E	• 6-Side Visual

TOLERANCE

Code	Description
A	± 0.05pF
B	± 0.1pF
C	± 0.25pF
D	± 0.50pF
K	± 10%
L	± 15%
M	± 20%
X	GMV (Guarantee Minimum Value)
Z	+80%, -20%

VOLTAGE

Code	Voltage
2	25 Volts
5	50 Volts

ORDERING INFORMATION — SLC — GAP CAP®

G	10	BU	100	K	5	P	X	10	
Product	Case Size	Material	Capacitance (pF)	Tolerance	Voltage	Termination	Test Level	Gap Width (mils)	Packaging
G = Gap-Cap®	10 15 20 25 30 35 50	See material tables on Page 5.	R01 = 0.01 pF OR5 = 0.5 pF 1R0 = 1.0 pF 5R1 = 5.1 pF 100 = 10 pF 511 = 510 pF Refer to Capacitance range tables for available values. Consult an inside sales rep for custom solutions.	A = ±0.05pF B = ±0.10pF C = ±0.25pF D = ±0.5pF F = ±1% G = ±2% J = ±5% K = ±10% L = ±15% M = ±20% Z = +80% -20%	2 = 25V 5 = 50V	P = Ni / Au M = Au	Y X A B D E See test level definitions on page 7.	05 08 10 15	T = Tape and Reel Leave blank for generic waffle pack. See packaging definitions on Page 8.

SLC — Gap Cap[®]

DIMENSIONS — 25 VOLT GAP CAP[®]

Style	Gap (Nominal)	Width	Length	Thickness
G10	0.005" (0.127mm)	0.010" + 0/-0.003" (0.254mm + 0/-0.076mm)	0.030" MAX. (0.762mm MAX.)	0.004" ± 0.001" (0.102mm ± 0.025mm)
G15	0.008" (0.203mm)	0.015" + 0/-0.003" (0.381mm + 0/-0.076mm)	0.040" MAX. (1.016mm MAX.)	
G20	0.010" (0.254mm)	0.020" + 0/-0.003" (0.508mm + 0/-0.076mm)	0.050" MAX. (1.270mm MAX.)	
G25	0.020" (0.508mm)	0.025" + 0/-0.003" (0.635mm + 0/-0.076mm)	0.060" MAX. (1.524mm MAX.)	
G30		0.030" + 0/-0.003" (0.762mm + 0/-0.076mm)		
G35		0.035" ± 0.005" (0.889mm ± 0.127mm)		
G50		0.050" ± 0.010" (1.27mm ± 0.254mm)	0.080" MAX. (2.032mm MAX.)	0.006" ± 0.001" (0.102mm ± 0.064mm)

*UX thickness 0.006" (0.152mm)

DIMENSIONS — 50 VOLT GAP CAP[®]

Style	Gap (Nominal)	Width	Length	Thickness
G10	0.005" (0.127mm)	0.010" + 0/-0.003" (0.254mm + 0/-0.076mm)	0.030" MAX. (0.762mm MAX.)	0.006" ± 0.001" (0.102mm ± 0.064mm)
G15	0.008" (0.203mm)	0.015" + 0/-0.003" (0.381mm + 0/-0.076mm)	0.040" MAX. (1.016mm MAX.)	
G20	0.010" (0.254mm)	0.020" + 0/-0.003" (0.508mm + 0/-0.076mm)	0.050" MAX. (1.270mm MAX.)	
G25	0.020" (0.508mm)	0.025" + 0/-0.003" (0.635mm + 0/-0.076mm)	0.080" MAX. (2.032mm MAX.)	
G30		0.030" + 0/-0.003" (0.762mm + 0/-0.076mm)		
G35		0.035" ± 0.005" (0.889mm ± 0.127mm)		
G50		0.050" ± 0.010" (1.27mm ± 0.254mm)		0.006" ± 0.001" (0.102mm ± 0.064mm)

*UX thickness 0.010" (0.254mm)

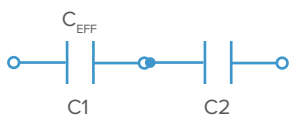

$$C_{EFF} = \text{SERIES EQUIVALENT}$$

$$C1 = C2 \quad C_{EFF} = C1 \div 2$$

ALL GAP CAP VALUES ARE LISTED AS C_{EFF}

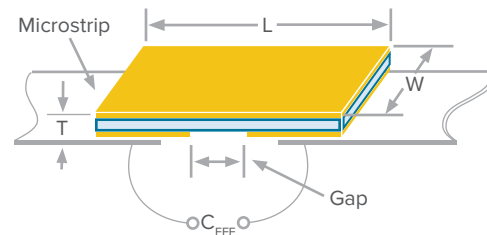
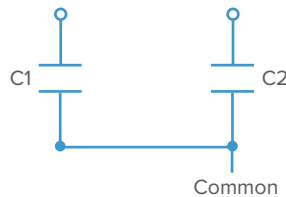

SLC — Gap Cap®

CAPACITANCE VALUES — 25 VOLT RATED GAP CAP®

STYLE	G10			G15			G20			G25			G30			G35			G50		
CAPACITANCE (pF)																					
MATERIAL	MIN.	MAX.	TOL.	MIN.	MAX.	TOL.	MIN.	MAX.	TOL.	MIN.	MAX.	TOL.	MIN.	MAX.	TOL.	MIN.	MAX.	TOL.	MIN.	MAX.	TOL.
PI	0.02	0.03	A	0.03	0.07	A	0.04	0.10	A	0.05	0.15	A	0.06	0.15	A	0.07	0.20	A	-	-	-
PG	0.02	0.05	A	0.04	0.10	A	0.05	0.15	A	0.07	0.20	A	0.08	0.25	A	0.09	0.25	A	-	-	-
AH	0.04	0.08	A	0.06	0.15	A	0.08	0.25	A	0.10	0.30	A	0.15	0.35	A	0.15	0.45	A	-	-	-
CF	0.04	0.09	A	0.08	0.15	A	0.10	0.30	A	0.15	0.35	A	0.15	0.45	A	0.20	0.50	A	-	-	-
NA	0.04	0.08	A	0.07	0.15	A	0.09	0.25	A	0.15	0.35	A	0.15	0.40	A	0.15	0.50	A	-	-	-
CD	0.06	0.10	A	0.15	0.25	A	0.15	0.45	A	0.20	0.60	B	0.25	0.70	B	0.30	0.80	B	-	-	-
CG	0.15	0.25	A	0.25	0.50	A	0.30	0.90	B	0.35	1.1	B	0.45	1.3	C	0.50	1.6	C	-	-	-
DB	0.15	0.25	A	0.25	0.55	B	0.30	0.90	B	0.35	1.1	B	0.45	1.4	C	0.50	1.6	C	-	-	-
NP	0.15	0.30	A	0.30	0.65	B	0.35	1.1	C	0.40	1.3	C	0.55	1.6	C	0.60	1.9	C	-	-	-
NR	0.25	0.60	A,B	0.50	1.2	B	0.65	2.0	C	0.75	2.4	C	0.95	3.0	D	1.1	3.6	D	-	-	-
NS	0.50	1.2	B	0.90	2.2	C,K	1.2	3.9	D,K	1.4	4.7	D,K	1.8	5.6	D,K	2.2	6.8	K	-	-	-
NU	0.95	2.4	C,K	1.8	4.3	C,K	2.4	7.5	D,K	3.0	9.1	D,K	3.6	11	K	4.3	13	K	-	-	-
NV	1.4	3.6	C,K	2.7	6.8	D,K	3.6	11	D,K	4.3	13	K	5.6	16	K	6.2	20	K	-	-	-
BD	1.1	2.7	K	2.2	5.1	K	2.7	9.1	K	3.3	11	K	4.3	13	K	5.1	16	K	-	-	-
BC	2.0	5.1	K	3.9	10	K	5.1	16	K	6.2	20	K	8.2	24	K	9.1	27	K	-	-	-
BE	2.0	4.7	K	3.9	9.1	K	5.1	16	K	6.2	20	K	7.5	24	K	9.1	27	K	-	-	-
BL	3.3	7.5	K	6.2	15	K	8.2	24	K	10	30	K	12	39	K	15	43	K	-	-	-
BJ	5.1	13	K	10	24	K	13	43	K	16	51	K	20	62	K	24	75	K	-	-	-
BN	7.5	18	K	15	33	K	18	56	K	22	68	K	27	82	K	33	100	K	-	-	-
BU	15	33	K,M	27	62	K,M	33	110	K,M	43	130	K,M	51	160	K,M	62	180	K,M	-	-	-
BV	22	51	M	43	100	M	51	160	M	68	200	M	82	240	M	100	300	M	-	-	-
UX	40	60	M	90	120	M	150	200	M	190	250	M	265	300	M	310	350	M	500	800	M

CAPACITANCE VALUES — 50 VOLT RATED GAP CAP®

STYLE	G10			G15			G20			G25			G30			G35			G50		
CAPACITANCE (pF)																					
MATERIAL	MIN.	MAX.	TOL.	MIN.	MAX.	TOL.	MIN.	MAX.	TOL.	MIN.	MAX.	TOL.	MIN.	MAX.	TOL.	MIN.	MAX.	TOL.	MIN.	MAX.	TOL.
PI	0.02	0.02	A	0.03	0.05	A	0.03	0.08	A	0.04	0.15	A	0.05	0.15	A	0.06	0.20	A	0.07	0.35	A
PG	0.02	0.03	A	0.03	0.06	A	0.04	0.10	A	0.05	0.20	A	0.07	0.25	A	0.07	0.25	A	0.09	0.50	A
AH	0.03	0.05	A	0.05	0.10	A	0.06	0.15	A	0.08	0.30	A	0.10	0.35	A	0.15	0.45	A	0.15	0.75	A,B
CF	0.03	0.06	A	0.06	0.10	A	0.07	0.20	A	0.09	0.35	A	0.15	0.45	A	0.15	0.50	A	0.20	0.90	A,B
NA	0.03	0.05	A	0.05	0.10	A	0.07	0.15	A	0.08	0.35	A	0.15	0.40	A	0.15	0.45	A	0.20	0.85	A,B
CD	0.04	0.09	A	0.08	0.15	A	0.15	0.30	A	0.15	0.55	A	0.20	0.70	A,B	0.20	0.80	A,B	0.30	1.4	A,B
CG	0.08	0.15	A	0.15	0.35	A	0.20	0.60	A	0.30	1.1	A	0.35	1.3	A,B	0.40	1.5	A,B	0.50	2.7	A,B
DB	0.08	0.15	A	0.20	0.35	A	0.25	0.60	A	0.30	1.1	A,B	0.35	1.3	B,C	0.40	1.6	B,C	0.50	2.7	B,C
NP	0.09	0.20	A	0.20	0.40	A	0.25	0.70	B	0.35	1.3	B	0.40	1.6	B,C	0.50	1.9	B,C	0.60	3.3	B,C
NR	0.20	0.40	A	0.35	0.80	B	0.45	1.3	B,C	0.60	2.4	B,C	0.75	3.0	D	0.90	3.6	D	1.2	6.2	D,K
NS	0.35	0.8	C,K	0.65	1.5	C,K	0.85	2.4	C,K	1.1	4.7	C	1.4	5.6	D,K	1.6	6.2	D,K	2.2	11	D,K
NU	0.65	1.6	C,K	1.3	3.0	C,K	1.7	5.1	D,K	2.2	9.1	D,K	3.0	11	K	3.3	13	K	4.3	22	K
NV	0.95	2.4	C,K	2.0	4.7	C,K	2.7	7.5	D,K	3.3	13	D,K	4.3	16	K	5.1	20	K	6.2	33	K
BD	0.75	1.8	K	1.5	3.6	K	2.0	5.6	K	2.7	11	K	3.3	13	K	3.9	15	K	5.1	27	K
BC	1.4	3.3	K	3.0	3.8	K	3.9	11	K	4.7	20	K	6.2	24	K	7.5	27	K	9.1	51	K
BE	1.4	3.3	K	2.7	6.2	K	3.6	10	K	4.7	20	K	6.2	24	K	6.8	27	K	9.1	4.7	K
BL	2.2	5.1	K	4.3	10	K	6.2	16	K	7.5	30	K	10	36	K	11	43	K	15	75	K
BJ	3.6	8.2	K	7.5	16	K	10	27	K	12	51	K	16	62	K	18	68	K	24	120	K
BN	5.1	12	K	10	22	K	13	39	K	18	68	K	22	82	K	24	100	K	33	160	K
BU	9.1	22	M	20	43	M	24	68	M	33	130	M	43	160	M	47	180	M	62	330	M
BV	15	36	M	30	68	M	39	110	M	51	200	M	68	240	M	75	300	M	100	510	M
UX	60	70	M	90	120	M	140	160	M	180	190	M	200	250	M	380	550	M	600	1,000	M



SLC — Bi-Cap[®]

Binary Tunable Caps for Single-Layer Hybrids.

FUNCTIONAL APPLICATIONS

- Matching Networks
- Tank Circuits
- Tuning
- Coupling

BENEFITS

- Small size compatible with microwave geometries
- Hybrid Circuits — engineering designs
- Operating frequency up to 30GHz
- Customized solutions

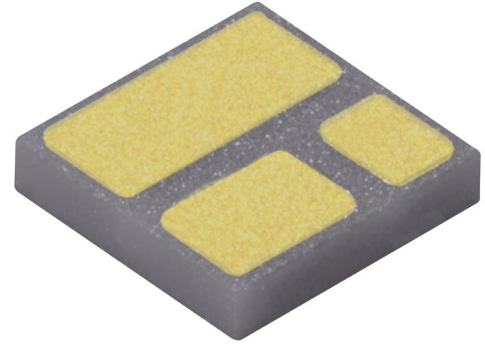

TEST LEVEL CODES

Commercial Level

X	100% 4-Side Visual 1% AQL Electrical (CAP/DF/IR & DWV)
---	---

HIGH RELIABILITY

A	MIL-PRF-49464 Group A	B	MIL-PRF-49464 Group B
	<ul style="list-style-type: none"> • 100% Thermal Shock • 100% Voltage Conditioning • 100% Electrical (CAP/DF/IR & DWV) • 100% 6-Side Visual • Bond Strength • Die Shear • Temperature Coefficient 		<ul style="list-style-type: none"> • MIL-PRF-49464 Group A • Immersion • Low Voltage Humidity • Life
		D	• Customer Defined
		E	• 6-Side Visual

TOLERANCE

Code	Description
A	± 0.05pF
B	± 0.1pF
C	± 0.25pF
D	± 0.50pF
K	± 10%
L	± 15%
M	± 20%
X	GMV (Guarantee Minimum Value)
Z	+80%, -20%

VOLTAGE

Code	Voltage
2	25 Volts
5	50 Volts
1	100 Volts

ORDERING INFORMATION — SLC — Bi-CAP[®]

F	15	NR	OR1	M	1	P	X	3	
Product	Case Size	Material	Capacitance (pF)	Tolerance	Voltage	Termination	Test Level	Pad Quantity	Packaging
F = Binary Capacitors	15 20 25 35 40	See material tables on Page 5.	Lowest Value in Series is Part Number R08 = .080 pF OR1 = .1 pF OR2 = .2 pF OR4 = .4 pF OR5 = .5 pF Consult an inside sales rep for custom solutions.	M = ± 20%	2 = 25V 5 = 50V 1 = 100V	P = Ni / Au M = Au	X See test level definitions on page 7.	3 4	T = Tape and Reel Leave blank for generic waffle pack. See packaging definitions on Page 8.



SLC — Bi-Cap[®]

Part Number	No. of Caps	Values (pF)	Voltage (WVDC)	Length	Width	Thickness	Border
F15CGR08M5PX3	3	0.08, 0.15, 0.3	50	0.015" ± 0.001" (0.381mm ± 0.025mm)	0.015" ± 0.001" (0.381mm ± 0.025mm)	0.004" ± 0.001" (0.102mm ± 0.025mm)	0.002" (0.051mm)
F15NR0R1M1PX3	3	0.1, 0.2, 0.4	100	0.015" ± 0.001" (0.381mm ± 0.025mm)	0.015" ± 0.001" (0.381mm ± 0.025mm)	0.006" ± 0.001" (0.152mm ± 0.025mm)	
F20CG0R1M1PX3	3	0.1, 0.2, 0.4	100	0.020" ± 0.001" (0.508mm ± 0.025mm)	0.020" ± 0.001" (0.508mm ± 0.025mm)	0.006" ± 0.001" (0.152mm ± 0.025mm)	
F20NR0R2M1PX3	3	0.2, 0.4, 0.8	100	0.020" ± 0.001" (0.508mm ± 0.025mm)	0.020" ± 0.001" (0.508mm ± 0.025mm)	0.006" ± 0.001" (0.152mm ± 0.025mm)	
F25CFR08M5PX3	3	0.08, 0.15, 0.3	50	0.025" ± 0.001" (0.635mm ± 0.025mm)	0.025" ± 0.001" (0.635mm ± 0.025mm)	0.004" ± 0.001" (0.102mm ± 0.025mm)	
F25CG0R2M1PX3	3	0.2, 0.4, 0.8	100	0.025" ± 0.001" (0.635mm ± 0.025mm)	0.025" ± 0.001" (0.635mm ± 0.025mm)	0.006" ± 0.001" (0.152mm ± 0.025mm)	
F25NR0R4M1PX3	3	0.4, 0.8, 1.6	100	0.025" ± 0.001" (0.635mm ± 0.025mm)	0.025" ± 0.001" (0.635mm ± 0.025mm)	0.006" ± 0.001" (0.152mm ± 0.025mm)	
F35CF0R1M1PX3	3	0.1, 0.2, 0.4	100	0.035" ± 0.001" (0.889mm ± 0.025mm)	0.035" ± 0.001" (0.889mm ± 0.025mm)	0.006" ± 0.001" (0.152mm ± 0.025mm)	
F35CG0R4M1PX3	3	0.4, 0.8, 1.6	100	0.035" ± 0.001" (0.889mm ± 0.025mm)	0.035" ± 0.001" (0.889mm ± 0.025mm)	0.006" ± 0.001" (0.152mm ± 0.025mm)	
F40NR0R5M1PX4	4	0.5, 1, 2, 4	100	0.040" ± 0.001" (1.016mm ± 0.025mm)	0.040" ± 0.001" (1.016mm ± 0.025mm)	0.0075" ± 0.001" (0.191mm ± 0.025mm)	

DIMENSIONS — Bi-CAP[®]

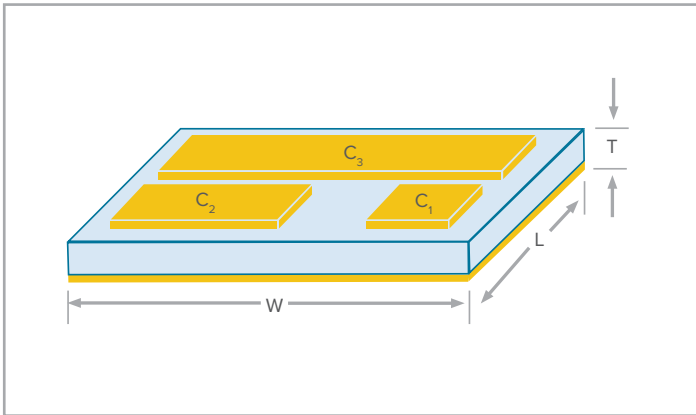

CIRCUIT DIAGRAM — Bi-CAP[®]

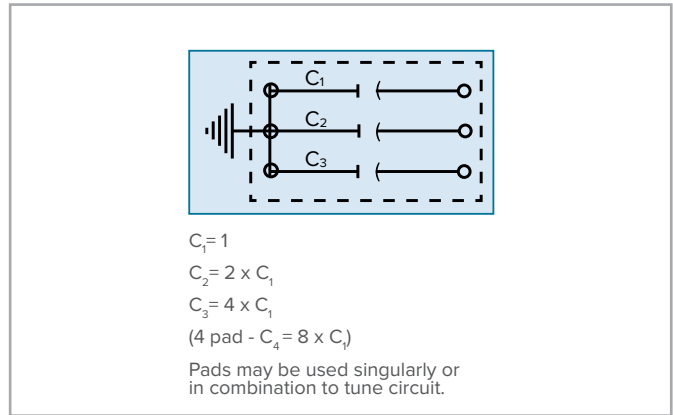

Materials and Metallization

Compex utilizes an extensive variety of materials in both Class I and Class II categories with dielectric constants ranging from 3.8 to 35,000 to fabricate our components. Other dielectric materials are available; please consult the sales office.

CLASS I DIELECTRIC MATERIALS:

This class of dielectrics consists of material exhibiting very low losses, extremely low or closely controlled temperature coefficients, negligible voltage and frequency coefficients, negligible aging effects and high insulation and dielectric breakdown.

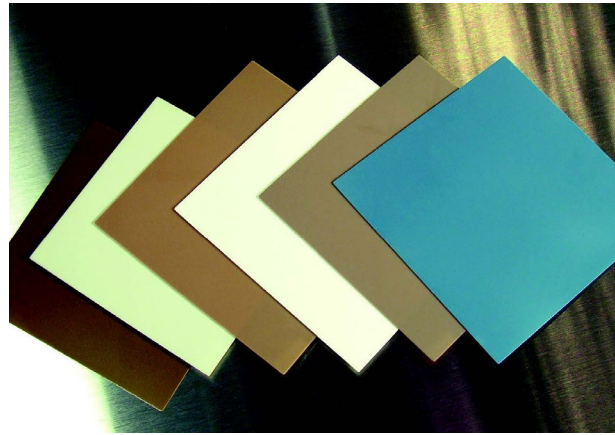

CLASS I DIELECTRIC MATERIALS

Type	Ins. Res (MEG-OHMS 100VDC @ 25°)	Temperature Coefficient PPM°C -55 to 125°C	Dissipation Factor (@ 10GHz)	Dielectric Constant (K)	Material
C-20	10 ⁶	Negligible	0.0001	3.8	Quartz
C-28		P120 ± 25	0.0001	8.7	AlN
C-30		P180 ± 50	0.0006	9.6	Alumina 96
C-35		P180 ± 50	0.0006	9.8	Alumina 99.6
C-37		NPO 0 ± 30	0.0001	12.6	Titanate
C-40		0 ± 30	0.0010	20	Titanate
C-50		0 ± 30	0.0020	40	Titanate
C-55		0 ± 30	0.0050	50	Titanate
C-58		0 ± 30	0.0050	93	Titanate
NR		N1500 ± 500	0.0025	150	Titanate

Typically used for submounts and substrates only.

CLASS II DIELECTRIC MATERIALS:

This class of material is characterized by high dielectric constants, increased losses, and higher temperature coefficients. These properties are inherent with this class of material, but the high dielectric constants permit the use of smaller size to achieve low series inductance and meet dimensional requirements. Capacitors made with these materials are often used for coupling of microstrip line circuits where the small chip size is necessary. Used as bypass capacitors, the small size provides low series inductance and dielectric losses are typically of little concern.

CLASS II DIELECTRIC MATERIALS

Type	Ins. Res (MEG-OHMS 100VDC @ 25°)	Temperature Coefficient (%) -55 to 125°C	Dissipation Factor (@ 1MHz)	Aging (%) HR/ Decade	Dielectric Constant (K)
C-80	10 ⁵	5 to -10	0.010	2.0	300
BD	10 ⁴	-10 to 10	0.025	3.0	800
C-BE	10 ⁴	-10 to 10	0.025	3.0	1,250
C-100	10 ⁵	3 to -10	0.015	3.5	2,200
C-120	10 ⁵	0 to -35	0.020	3.0	3,500
C-BN	10 ⁵	-15 to 15	0.030	3.0	4,400
C-140	10 ⁵	0 to -80	0.025	3.0	11,000
C-200	*	-15 to 15	0.035	3.0	25,000
C-400	*	-15 to 15	0.035	3.0	35,000

* Please consult the factory for specific ratings to meet your application requirements.

Note: MHz @1V <100pF, 1KHz @1V >100pF Voltage Rating: ≤5 mils thick-50 WVDC (25 WVDC for 200 material), >5 mils thick-100 WVDC (50 WVDC for 200 material). Insulation Resistance tested at 50 volts for all materials except C-200. C-200 tested at WVDC that is 16-25V for ≤6 mils thick and 25-50V for >6 mils.

NEW MATERIAL

C-400: Ultra High K X7R material.
Capacitance change ± 15% from -55 to 125°C.
200pF in a 10 x 10 size.
1,000pF in a 25 x 25 size.

SUBSTRATES CAN BE SUPPLIED AS FOLLOWS:

- Metallized
 - gold over platinum, palladium or nickel
 - silver over platinum
 - custom schemes and patterns to customer specifications
- Thickness range: mils and up
- Length and Width: up to 4" depending on material

STANDARD ELECTRODE METALLIZATIONS

GOLD (G): This metallization consists of a minimum of 70 micro-inches of gold over non-magnetic leach-resistant nickel or platinum, which is ideal for all wire bonding methodologies. Please consult our factory for optimum metallization options for solder applications.

SILVER (S): This metallization consists of 20 micro-inches of silver over platinum, which is ideal for all solder applications whenever the use of gold is unacceptable.

Typical Temperature Characteristics

C-30/C-37/C-40/C-50/C-55/C-58

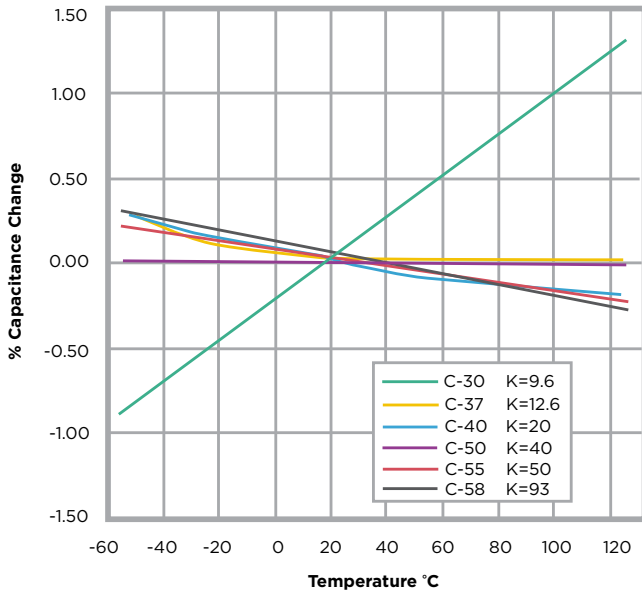

C-NR/C-80/C-BD (C-BE)/C-100

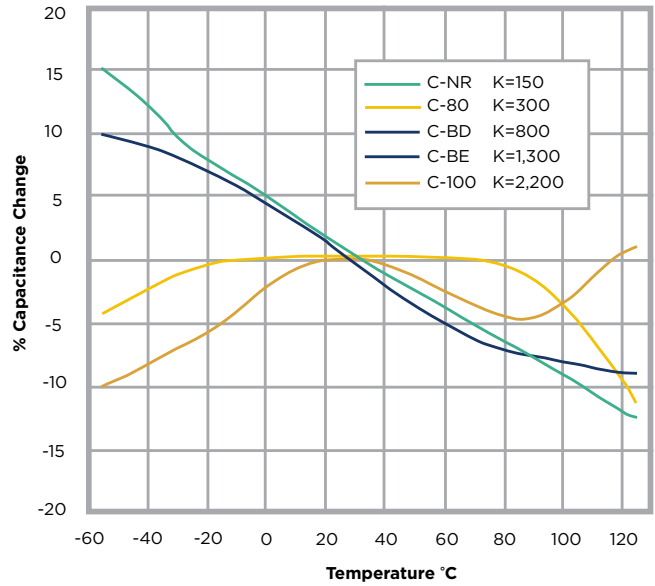

C-120/C-BN/C-140

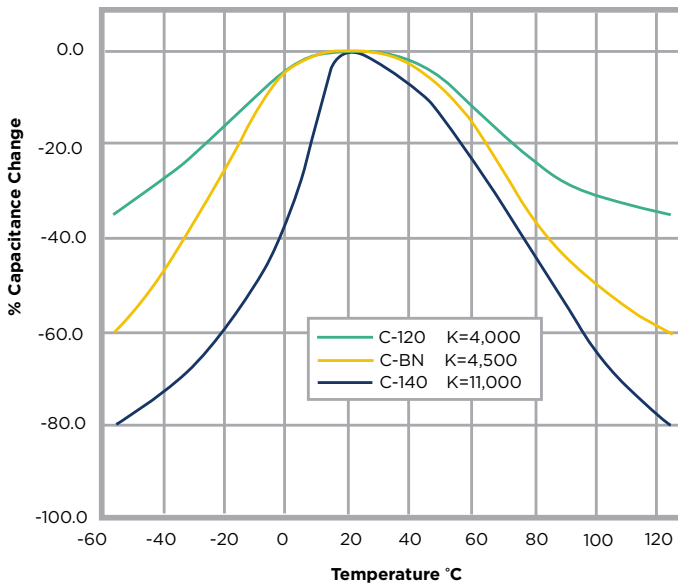

C-200/C-400

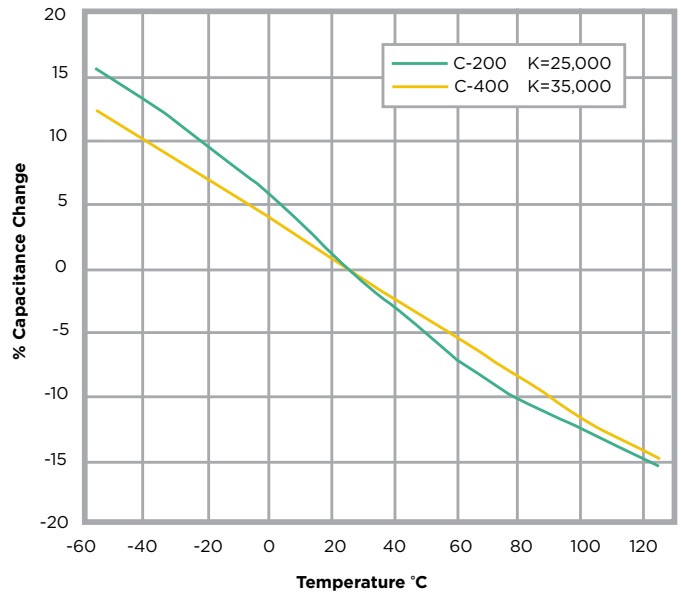

CSA Series — Edge-to-Edge Capacitors

This classic two-electrode design is the simplest and most widely used. The chip size, shape and electrical properties may be determined from the dielectric material data and the CSA Selection Chart. Complex is the leader in supplying the LC filter market with custom value parallel plate capacitors. We manufacture tight tolerance, custom filter capacitors to the required size, shape and value for minimization of post build tuning requirements. Thicknesses of up to 25+ mils are available, utilizing temperature-stable low-loss materials and special terminations to improve the all solder process.



DESCRIPTION

- Capacitance: 0.04 to 10,000 picofarads and beyond
- Square or rectangle, length or width .005" and up

CSA STANDARD CAPACITANCE TOLERANCE CODES

Class I Dielectrics: C-20 thru C-NR				Class II Dielectrics: C-80 thru C-400			
Tolerance	Code	Tolerance	Code	Tolerance	Code	Tolerance	Code
±.50pF	D	± 20%	M	-20% thru +80%	Z	± 20%	M
±.25pF	C	± 15%	L	-10% thru +40%	Y	± 15%	L
±.10pF	B	± 10%	K	-0% thru +100%	V	± 10%	K
±.05pF	A	± 5%	J	Guaranteed Min. Value	GMV	± 5%	J
±.01pF	P	± 3%	H	-	-	-	-
-	-	± 2%	G	-	-	-	-

CSA CHIP DIMENSIONS

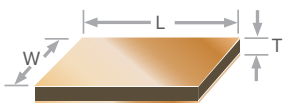

To determine rectangular chip dimensions, divide the total chip area by the required length or width to obtain the remaining dimension.

CSA STANDARD DIMENSIONAL TOLERANCES

Material	L or W Dimension	Tolerance
C-20 through C-140	< 20 mils	± 15%
	≥ 20 mils	± 10%
C-200 and C-400	≤ 15 mils	± 2 mils
	>15 mils; ≤ 30 mils	± 3 mils
	> 30 mils	± 5 mils

CSA ELECTRODE CONFIGURATION

Two electrodes



ORDERING INFORMATION — CSA SERIES — EDGE-TO-EDGE CAPACITORS

CSA Cap Style	200 Dielectric Type	10 x 10 Length x Width (mils)	x 6 Thickness (mils)	G Metallization	101 Capacitance (pF)	M Capacitance Tolerance
-	See Class I and Class II tables (page 26)	See CSA Chip Dimensions (at right)	See CSA Selection Chart (at right)	G = Gold S = Silver Custom	First two digits represent significant figures and the last, the number of zeros to follow. When required, the letter "R" is used as a decimal point and the succeeding digits represent significant figures only. e.g.: 101 = 100pF, 1R6 = 1.6pF	See CSA Standard Capacitance Tolerance Codes (below)

Note: Standard dimensional tolerance for length and width is ±15% up to 20 mils. For dimensions greater than 20 mils, standard tolerance is ±10%. For C-200 and C-400 material, see table on right. In cases where dimensions cannot be exceeded, insert "M" to signify a Maximum dimension. The thickness tolerance is ±1.5 mils.

Example shown: Complex Series CSM, dielectric type C-BD/BE, .010" x .010" x .005", gold, 2.7pF, ±20% tolerance

Please contact factory to request free samples.

CSA Series — Edge-to-Edge Capacitors

CSA SELECTION CHART

Note: Selection Chart is for guidance only. All Compex parts are built to specific customer requirements.

Capacitor Size in Mils (mm)

Cap. (pF)	10x10 (.254x.254)		12x12 (.305x.305)		15x15 (.381x.381)		20x20 (.508x.508)		25x25 (.635x.635)		30x30 (.762x.762)		35x35 (.889x.889)		40x40 (1.016x1.016)		50x50 (1.27x1.27)	
	Diel.	Thick.	Diel.	Thick.	Diel.	Thick.	Diel.	Thick.	Diel.	Thick.	Diel.	Thick.	Diel.	Thick.	Diel.	Thick.	Diel.	Thick.
0.04	C-30	5	C-30	6	C-30	10												
0.06	C-30	4	C-30	5	C-30	8	C-20	5	C-20	10								
0.08	C-50	10	C-30	4	C-30	6	C-30	10	C-20	7	C-20	9						
0.1	C-50	8	C-50	11	C-30	5	C-30	9	C-20	5	C-20	7	C-20	10				
0.2	C-50	5	C-50	7	C-50	10	C-30	4	C-30	7	C-30	10	C-20	5	C-20	7	C-20	10
0.3	C-58	6	C-50	4	C-50	6	C-50	11	C-30	4	C-30	7	C-30	9	C-20	5	C-20	7
0.4	C-58	5	C-58	7	C-50	5	C-50	9	C-50	15	C-30	5	C-30	7	C-30	9	C-20	5
0.5	C-58	4	C-58	5	C-50	4	C-50	7	C-50	11	C-30	5	C-30	5	C-30	7	C-20	4
0.6	C-NR	6	C-58	5	C-58	7	C-50	6	C-50	10	C-50	15	C-30	4	C-30	6	C-30	9
0.8	C-80	8	C-NR	6	C-58	5	C-50	5	C-50	7	C-50	10	C-50	15	C-30	4	C-30	7
1	C-80	7	C-NR	5	C-58	4	C-58	7	C-50	6	C-50	8	C-50	10	C-30	4	C-30	5
1.2	C-80	6	C-NR	4	C-58	4	C-58	6	C-50	5	C-50	7	C-50	9	C-30	3	C-30	5
1.5	C-80	5	C-80	7	C-NR	5	C-58	5	C-50	4	C-50	6	C-50	7	C-50	10	C-30	4
1.8	C-80	4	C-80	5	C-NR	4	C-58	4	C-58	6	C-50	5	C-50	6	C-50	8	C-50	11
2	C-80	4	C-80	5	C-NR	4	C-NR	7	C-58	6	C-50	4	C-50	5	C-50	7	C-50	11
2.2	C-BD/ BE	4	C-80	5	C-NR	4	C-NR	6	C-58	5	C-58	7	C-50	5	C-50	7	C-50	10
2.7	C-BD/ BE	8	C-80	4	C-80	6	C-NR	5	C-58	4	C-58	6	C-50	4	C-50	5	C-50	8
3.3	C-BD/ BE	7	C-BD/ BE	10	C-80	5	C-NR	4	C-NR	6	C-58	5	C-58	7	C-50	4	C-50	7
3.9	C-BD/ BE	6	C-BD/ BE	9	C-80	4	C-80	7	C-NR	5	C-58	4	C-58	6	C-58	8	C-50	6
4.7	C-BD/ BE	5	C-BD/ BE	7	C-BD/ BE	11	C-80	6	C-NR	4	C-NR	6	C-58	5	C-58	6	C-50	5
5.6	C-BD/ BE	4	C-BD/ BE	6	C-BD/ BE	10	C-80	4	C-80	7	C-NR	5	C-58	4	C-58	5	C-50	4
6.8	C-BD/ BE	4	C-BD/ BE	5	C-BD/ BE	8	C-80	4	C-80	6	C-NR	5	C-NR	6	C-58	4	C-58	7
8.2	C-100	6	C-BD/ BE	4	C-BD/ BE	7	C-80	4	C-80	5	C-NR	4	C-NR	5	C-NR	7	C-NR	10
10	C-100	5	C-BD/ BE	4	C-BD/ BE	5	C-BD/ BE	9	C-80	4	C-80	6	C-NR	4	C-NR	5	C-NR	8
12	C-100	4	C-100	6	C-BD/ BE	5	C-BD/ BE	8	C-BD/ BE	11	C-80	5	C-80	7	C-NR	4	C-NR	7
15	C-120	6	C-100	5	C-BD/ BE	4	C-BD/ BE	6	C-BD/ BE	10	C-80	4	C-80	6	C-80	7	C-NR	6
18	C-120	5	C-100	4	C-100	6	C-BD/ BE	5	C-BD/ BE	8	C-BD/ BE	11	C-80	4	C-80	6	C-NR	5
20	C-120	5	C-100	4	C-100	6	C-BD/ BE	5	C-BD/ BE	8	C-BD/ BE	11	C-80	4	C-80	5	C-NR	4



CSA Series — Edge-to-Edge Capacitors

CONTINUED

Capacitor Size in Mils (mm)

Cap. (pF)	10x10 (.254x.254)		12x12 (.305x.305)		15x15 (.381x.381)		20x20 (.508x.508)		25x25 (.635x.635)		30x30 (.762x.762)		35x35 (.889x.889)		40x40 (1.016x1.016)		50x50 (1.27x1.27)				
	Diel.	Thick.	Diel.	Thick.	Diel.	Thick.	Diel.	Thick.	Diel.	Thick.	Diel.	Thick.	Diel.	Thick.	Diel.	Thick.	Diel.	Thick.			
22	C-120	4	C-120	6	C-100	5	C-BD/BE	4	C-BD/BE	7	C-BD/BE	9	C-80	4	C-80	5	C-NR	4			
27	C-120	4	C-120	5	C-100	4	C-BD/BE	4	C-BD/BE	6	C-BD/BE	8	C-80	3	C-80	4	C-80	6			
33	C-BN	4	C-120	4	C-120	6	C-100	6	C-BD/BE	5	C-BD/BE	6	C-BD/BE	11	C-80	4	C-80	5			
39	C-140	6	C-120	4	C-120	5	C-100	5	C-BD/BE	4	C-BD/BE	5	C-BD/BE	7	C-BD/BE	10	C-80	4			
47	C-140	5	C-140	7	C-120	5	C-100	4	C-100	6	C-BD/BE	5	C-BD/BE	6	C-BD/BE	8	C-80	4			
56	C-140	4	C-140	6	C-BN	5	C-120	7	C-100	5	C-BD/BE	4	C-BD/BE	5	C-BD/BE	7	C-BD/BE	10			
68	C-140	4	C-140	5	C-BN	4	C-120	6	C-100	5	C-100	6	C-BD/BE	4	C-BD/BE	6	C-BD/BE	9			
82	C-200	7	C-140	4	C-140	7	C-BN	6	C-100	4	C-100	5	C-100	7	C-100	10	C-BD/BE	7			
100	C-200	6	C-200	8	C-140	6	C-BN	5	C-120	6	C-100	5	C-100	6	C-100	8	C-BD/BE	6			
120	C-200	5	C-200	7	C-140	5	C-140	8	C-BN	6	C-100	4	C-100	5	C-100	7	C-BD/BE	5			
150	C-200	4	C-200	5	C-140	4	C-140	7	C-BN	5	C-BN	7	C-100	4	C-100	5	C-BD/BE	4			
180	C-400	4	C-200	5	C-200	7	C-140	6	C-BN	4	C-BN	6	C-BN	8	C-120	8	C-100	7			
200	C-400	4	C-200	4	C-200	6	C-140	5	C-140	8	C-BN	5	C-BN	7	C-120	7	C-100	6			
220	C-400	4	C-400	5	C-200	6	C-140	4	C-140	7	C-BN	5	C-BN	6	C-120	6	C-100	6			
270			C-400	4	C-200	5	C-200	8	C-140	6	C-BN	4	C-BN	5	C-120	5	C-100	5			
330					C-200	4	C-200	7	C-140	5	C-140	7	C-BN	4	C-120	4	C-120	7			
390					C-400	5	C-200	6	C-140	4	C-140	6	C-140	7	C-140	10	C-120	6			
470					C-400	4	C-200	5	C-200	7	C-140	5	C-140	6	C-140	8	C-120	5			
560							C-200	4	C-200	6	C-140	4	C-140	5	C-140	7	C-120	4			
680							C-400	5	C-200	5	C-200	8	C-140	5	C-140	6	C-BN	4			
820							C-400	4	C-400	6	C-200	6	C-140	4	C-140	5	C-140	7			
1000									C-400	5	C-200	5	C-200	7	C-140	4	C-140	6			
1200									C-400	4	C-200	4	C-200	6	C-200	7	C-140	5			
1500	Class II Dielectrics										C-400	5	C-200	5	C-200	6	C-140	4			
1800														C-400	4	C-400	6	C-200	5	C-200	8
2200																C-400	5	C-200	4	C-200	6
2700																C-400	4	C-400	5	C-200	5
3300																				C-400	6



CSM Series — Margin Capacitors

Margin caps have the topside electrode withdrawn from the edges in order to increase the distance between electrodes and dramatically decrease the possibilities of shorting when epoxy die-mounting. This style is also widely used for optical recognition-based assembly.

Increased margin sizes and special terminations are available for high power LC filter applications.

DESCRIPTION

- Margin capacitors can be customized to any sized square or rectangle

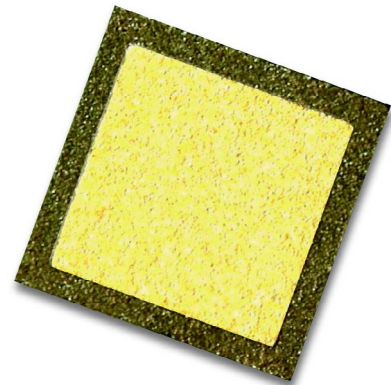

CSA STANDARD CAPACITANCE TOLERANCE CODES

Class I Dielectrics: C-20 thru C-NR

Tolerance	Code	Tolerance	Code
± .50pF	D	± 20%	M
± .25pF	C	± 15%	L
± .10pF	B	± 10%	K
± .05pF	A	± 5%	J
± .01pF	P	± 3%	H
-	-	± 2%	G

Class II Dielectrics: C-80 thru C-400

Tolerance	Code	Tolerance	Code
-20% thru +80%	Z	± 20%	M
-10% thru +40%	Y	± 15%	L
-0% thru +100%	V	± 10%	K
Guaranteed Min. Value	GMV	± 5%	J
-	-	-	-
-	-	-	-

CSM CHIP DIMENSIONS

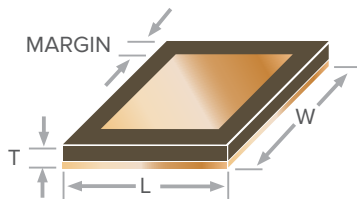

CSM STANDARD DIMENSIONAL TOLERANCES

Length & Width	L or W Tolerance	Margin Nominal	Thickness
≤.010	± .002	.001	± .0015
.011 thru .029	± .002	.002	
≥.030	± .003	.002	
All dimensions given are inches			

CSM ELECTRODE CONFIGURATION

Two electrodes



ORDERING INFORMATION — CSA SERIES — MARGIN CAPACITORS

CSM Style	90 Dielectric Type	10 x 10 Length x Width (mils)	x 5 Thickness (mils)	G Metallization	2R7 Capacitance (pF)	M Capacitance Tolerance
-	See Class I and Class II tables (page 26)	See CSA Chip Dimensions (at right)	See CSA Selection Chart (at right)	G = Gold	First two digits represent significant figures and the last, the number of zeros to follow. When required, the letter "R" is used as a decimal point and the succeeding digits represent significant figures only. e.g.: 101 = 100pF, 1R6 = 1.6pF	See CSM Standard Capacitance Tolerance Codes (below)

Example shown: Complex Series CSM, dielectric type C-BD/BE, .010" x .010" x .005", gold, 2.7pF, ±20% tolerance

Please contact factory to request free samples.



CSM Series — Margin Capacitors

CSM SELECTION CHART

Note: Selection Chart is for guidance only. All Compex parts are built to specific customer requirements.

Capacitor Size in Mils (mm)

Cap. (pF)	10x10 (.254x.254)		12x12 (.305x.305)		15x15 (.381x.381)		20x20 (.508x.508)		25x25 (.635x.635)		30x30 (.762x.762)		35x35 (.889x.889)		40x40 (1.016x1.016)		50x50 (1.27x1.27)	
	Diel.	Thick.	Diel.	Thick.	Diel.	Thick.	Diel.	Thick.	Diel.	Thick.	Diel.	Thick.	Diel.	Thick.	Diel.	Thick.	Diel.	Thick.
0.04	C-30	4	C-30	4	C-30	5	C-20	5							Class I Dielectrics			
0.06	C-50	10	C-30	4	C-30	6	C-20	5	C-20	8	C-20	10						
0.08	C-50	7	C-50	10	C-30	5	C-30	10	C-20	6	C-20	8	C-20	11				
0.1	C-50	6	C-50	9	C-50	4	C-30	7	C-20	5	C-20	7	C-20	10				
0.2	C-58	4	C-50	4	C-50	5	C-30	4	C-30	5	C-30	7	C-20	4	C-20	5	C-20	10
0.3	C-NR	6	C-58	5	C-58	4	C-50	8	C-30	4	C-30	5	C-30	7	C-20	4	C-20	6
0.4	C-NR	4	C-58	4	C-58	6	C-50	6	C-50	10	C-30	4	C-30	5	C-30	7	C-20	5
0.5	C-80	5	C-NR	4	C-58	5	C-50	4	C-50	7	C-50	10	C-30	4	C-30	6	C-30	10
0.6	C-80	5	C-NR	5	C-NR	4	C-50	4	C-50	6	C-50	10	C-30	4	C-30	5	C-30	7
0.8	C-80	5	C-80	5	C-NR	5	C-58	6	C-50	5	C-50	7	C-50	10	C-30	4	C-30	6
1	C-80	4	C-80	5	C-NR	4	C-58	5	C-50	4	C-50	6	C-50	8	C-50	10	C-30	5
1.2	C-BD/ BE	6	C-80	5	C-80	7	C-58	4	C-58	7	C-50	5	C-50	7	C-50	10	C-30	4
1.5	C-BD/ BE	7	C-80	4	C-80	6	C-NR	6	C-58	6	C-58	8	C-50	6	C-50	7	C-50	15
1.8	C-BD/ BE	6	C-80	4	C-80	5	C-NR	5	C-58	5	C-58	7	C-50	5	C-50	7	C-50	10
2	C-BD/ BE	6	C-BD/ BE	8	C-80	4	C-NR	5	C-58	5	C-58	6	C-50	4	C-50	6	C-50	10
2.2	C-BD/ BE	5	C-BD/ BE	7	C-80	4	C-80	7	C-NR	7	C-58	6	C-50	4	C-50	5	C-50	10
2.7	C-BD/ BE	5	C-BD/ BE	6	C-80	4	C-80	6	C-NR	6	C-58	6	C-58	8	C-50	5	C-50	8
3.3	C-100	6	C-BD/ BE	6	C-BD/ BE	8	C-80	5	C-NR	5	C-58	4	C-58	6	C-58	7	C-50	6
3.9	C-100	5	C-BD/ BE	5	C-BD/ BE	7	C-80	4	C-NR	4	C-NR	6	C-58	5	C-58	6	C-50	5
4.7	C-100	5	C-BD/ BE	5	C-BD/ BE	7	C-80	4	C-80	6	C-NR	5	C-58	4	C-58	5	C-58	8
5.6	C-100	5	C-100	6	C-BD/ BE	5	C-80	4	C-80	5	C-NR	4	C-NR	6	C-58	5	C-58	7
6.8	C-120	5	C-100	6	C-BD/ BE	5	C-BD/ BE	8	C-80	5	C-80	7	C-NR	5	C-NR	7	C-58	6
8.2	C-120	4	C-100	5	C-BD/ BE	4	C-BD/ BE	7	C-80	4	C-80	6	C-NR	4	C-NR	5	C-58	5
10	C-120	5	C-100	4	C-100	6	C-BD/ BE	6	C-80	4	C-80	5	C-80	6	C-NR	5	C-58	4
12	C-120	5	C-120	6	C-100	5	C-BD/ BE	5	C-BD/ BE	8	C-80	4	C-80	6	C-NR	4	C-NR	6
15	C-120	4	C-120	5	C-100	5	C-BD/ BE	5	C-BD/ BE	7	C-80	4	C-80	5	C-80	6	C-NR	5
18	C-BN	4	C-BN	6	C-120	7	C-100	7	C-BD/ BE	5	C-BD/ BE	9	C-80	4	C-80	5	C-NR	4
20	C-140	5	C-BN	5	C-120	6	C-100	6	C-BD/ BE	5	C-BD/ BE	8	C-80	4	C-80	5	C-NR	4



CSM Series — Margin Capacitors

CONTINUED

Capacitor Size in Mils (mm)

Cap. (pF)	10x10 (.254x.254)		12x12 (.305x.305)		15x15 (.381x.381)		20x20 (.508x.508)		25x25 (.635x.635)		30x30 (.762x.762)		35x35 (.889x.889)		40x40 (1.016x1.016)		50x50 (1.27x1.27)	
	Diel.	Thick.	Diel.	Thick.	Diel.	Thick.	Diel.	Thick.	Diel.	Thick.	Diel.	Thick.	Diel.	Thick.	Diel.	Thick.	Diel.	Thick.
22	C-140	7	C-BN	4	C-120	5	C-100	6	C-BD/BE	5	C-BD/BE	7	C-BD/BE	10	C-80	4	C-80	6
27	C-140	6	C-BN	4	C-BN	5	C-100	5	C-BD/BE	4	C-BD/BE	6	C-BD/BE	8	C-80	4	C-80	5
33	C-140	5	C-140	6	C-BN	4	C-100	4	C-100	6	C-BD/BE	5	C-BD/BE	7	C-BD/BE	9	C-80	5
39	C-140	4	C-140	5	C-BN	4	C-120	6	C-100	6	C-BD/BE	4	C-BD/BE	6	C-BD/BE	8	C-80	4
47	C-200	8	C-140	5	C-140	6	C-120	5	C-100	5	C-100	7	C-BD/BE	5	C-BD/BE	7	C-BD/BE	11
56	C-200	6	C-140	4	C-140	5	C-BN	5	C-100	4	C-100	6	C-BD/BE	4	C-BD/BE	6	C-BD/BE	9
68	C-200	5	C-200	8	C-140	5	C-BN	4	C-120	6	C-100	5	C-BD/BE	4	C-BD/BE	5	C-BD/BE	7
82	C-400	6	C-200	6	C-140	4	C-BN	4	C-120	5	C-100	4	C-100	6	C-BD/BE	4	C-BD/BE	6
100	C-400	5	C-200	6	C-140	4	C-140	6	C-BN	5	C-120	6	C-100	5	C-100	7	C-BD/BE	5
120			C-200	5	C-200	6	C-140	5	C-BN	4	C-BN	6	C-100	4	C-100	5	C-BD/BE	4
150			C-200	6	C-200	6	C-140	4	C-140	7	C-BN	5	C-BN	7	C-100	4	C-100	7
180			C-400	5	C-200	5	C-140	4	C-140	6	C-BN	4	C-BN	6	C-100	4	C-100	6
200					C-400	5	C-140	4	C-140	6	C-BN	4	C-BN	5	C-120	6	C-100	5
220					C-400	5	C-200	8	C-140	5	C-BN	4	C-BN	5	C-120	5	C-100	5
270					C-400	5	C-200	6	C-140	4	C-140	7	C-BN	4	C-BN	6	C-100	4
330							C-200	5	C-140	4	C-140	5	C-140	7	C-BN	5	C-120	6
390							C-200	5	C-200	6	C-140	5	C-140	6	C-BN	4	C-120	5
470							C-200	4	C-200	6	C-140	4	C-140	5	C-140	7	C-BN	5
560							C-400	5	C-400	6	C-140	4	C-140	5	C-140	6	C-BN	4
680									C-400	6	C-200	6	C-140	4	C-140	5	C-140	8
820									C-400	5	C-200	5	C-200	8	C-140	4	C-140	7
1000											C-400	6	C-200	6	C-200	8	C-140	6
1200											C-400	5	C-200	5	C-200	7	C-140	5
1500													C-400	6	C-400	5	C-140	4
1800													C-400	5	C-400	6	C-200	7
2200															C-400	5	C-200	6
2700																5	C-200	5
3300																	C-400	5



CSB Series — Dual-Pad Capacitors

A single full electrode is provided on one side of the capacitor and split electrodes on the other side. This is a three-terminal capacitor that can be used as two capacitors with a common electrode, or as serially connected capacitors so that connections may be made on one side of the chip only (surface-mount). This design is often used in microstrip coupling to eliminate lead inductance and raise the self resonance frequency.

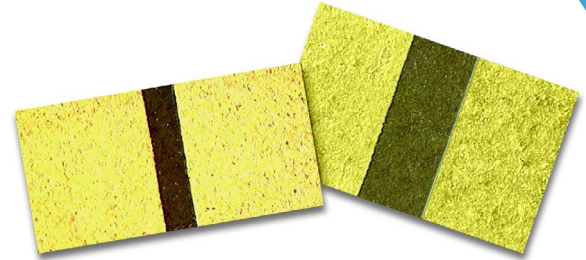

DESCRIPTION

- Capacitance: 0.06 picofarads and up
- Chip shapes: dual pads with gap
- Gap widths: 5, 10, 15, 20 mil or custom

CSA STANDARD CAPACITANCE TOLERANCE CODES

Class I Dielectrics: C-20 thru C-NR

Tolerance	Code	Tolerance
± 20pF	M	-10% thru +40%
± 15pF	L	-20% thru +80%
± 10pF	K	-0% thru +100%
± 5pF	J	Guaranteed Min. Value

Class II Dielectrics: C-80 thru C-400

Code	Tolerance	Code
Y	± 20%	M
Z	± 15%	L
V	± 10%	K
GMV		

CSB CHIP DIMENSIONS

This component functions as two capacitors operating in series, each of which is twice the desired equivalent capacitance. Allow us to custom design for your application.

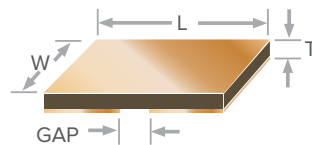

CSB ELECTRODE CONFIGURATION

Split electrodes

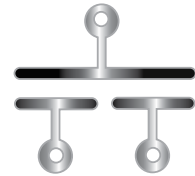

ORDERING INFORMATION — CSA SERIES — EDGE-TO-EDGE CAPACITORS

CSB Style	100 Dielectric Type	50 x 20 Length x Width (mils)	x 7 Thickness (mils)	10 Gap (mils)	G Metallization	120 Capacitance (pF)	M Capacitance Tolerance
-	See Class I and Class II tables (page 26)	See CSA Chip Dimensions (at right)	See CSA Selection Chart (at right)	5 or higher	G = Gold S = Silver Custom	First two digits represent significant figures and the last, the number of zeros to follow. When required, the letter "R" is used as a decimal point and the succeeding digits represent significant figures only. e.g.: 101 = 100pF, 1R6 = 1.6pF	See CSB Standard Capacitance Tolerance Codes (below)

Note: Standard dimensional tolerance for length and width is ±15% up to 20 mils. For dimensions greater than 20 mils, standard tolerance is ±10%. In cases where dimension cannot be exceeded, insert "M" to signify a Maximum dimension. The thickness tolerance is ±1.5 mils.

Example shown: Compex Series CSB, dielectric type C-100, .050" x .020" x .007", .01" gap, gold, 12pF, ±20% tolerance

Please contact factory to request free samples.

CSB Series — Dual-Pad Capacitors

CSB SELECTION CHART

Note: Selection Chart is for guidance only. All Compex parts are built to specific customer requirements.

Capacitor Size in Mils (mm)

Cap. (pF)	20x10 (.508x.508)		40x20 (1,016x.508)		60x30 (1,524x.762)		80x40 (2,032x1,016)	
	Diel.	Thick.	Diel.	Thick.	Diel.	Thick.	Diel.	Thick.
0.06	C-50	6	C-30	6	C-20	6	C-20	8
0.08	C-50	4	C-30	4	C-20	4	C-20	7
0.1	C-58	7	C-50	15	C-30	8	C-20	5
0.2	C-NR	6	C-50	7	C-30	4	C-30	7
0.3	C-80	8	C-50	5	C-50	10	C-30	4
0.4	C-80	6	C-58	7	C-50	8	C-50	15
0.5	C-80	5	C-58	6	C-50	7	C-50	10
0.6	C-80	4	C-58	5	C-50	6	C-50	9
0.8	C-BD/BE	11	C-NR	6	C-50	4	C-50	7
1	C-BD/BE	9	C-NR	5	C-58	7	C-50	6
1.2	C-BD/BE	7	C-NR	4	C-58	6	C-50	5
1.5	C-BD/BE	6	C-80	7	C-58	5	C-58	8
1.8	C-BD/BE	5	C-80	6	C-58	4	C-58	6
2	C-BD/BE	4	C-80	5	C-58	4	C-58	6
2.2	C-BD/BE	4	C-80	5	C-NR	6	C-58	5
2.7	C-100	7	C-80	4	C-NR	5	C-58	4
3.3	C-100	6	C-BD/BE	11	C-NR	4	C-NR	6
3.9	C-100	5	C-BD/BE	9	C-80	7	C-NR	5
4.7	C-100	4	C-BD/BE	8	C-80	5	C-NR	4
5.6	C-120	6	C-BD/BE	6	C-80	5	C-80	7
6.8	C-120	5	C-80	5	C-80	4	C-80	6
8.2	C-BN	5	C-BD/BE	4	C-BD/BE	11	C-80	5
10	C-BN	4	C-100	7	C-BD/BE	9	C-80	4
12	C-140	8	C-100	6	C-BD/BE	7	C-BD/BE	11
15	C-140	6	C-100	5	C-BD/BE	6	C-BD/BE	9

Capacitor Size in Mils (mm)

Cap. (pF)	20x10 (.508x.508)		40x20 (1,016x.508)		60x30 (1,524x.762)		80x40 (2,032x1,016)	
	Diel.	Thick.	Diel.	Thick.	Diel.	Thick.	Diel.	Thick.
18	C-140	5	C-100	4	C-BD/BE	5	C-BD/BE	8
20	C-140	5	C-120	7	C-BD/BE	4	C-BD/BE	7
22	C-140	4	C-120	6	C-BD/BE	4	C-BD/BE	6
27	C-200	8	C-120	5	C-100	7	C-BD/BE	5
33	C-200	6	C-BN	5	C-100	6	C-100	9
39	C-200	5	C-BN	4	C-100	5	C-100	8
47	C-400	6	C-140	8	C-100	4	C-100	6
56	C-400	5	C-140	7	C-120	6	C-100	5
68	C-400	4	C-140	5	C-120	5	C-120	8
82			C-140	4	C-BN	5	C-BN	8
100			C-200	8	C-BN	4	C-BN	7
120			C-200	7	C-140	8	C-BN	6
150			C-200	5	C-140	6	C-BN	5
180			C-200	5	C-140	5	C-140	8
200			C-400	6	C-140	5	C-140	7
220			C-400	5	C-200	9	C-140	7
270			C-400	4	C-200	8	C-140	6
330					C-200	6	C-140	5
390					C-200	5	C-200	9
470					C-400	6	C-200	7
560					C-400	5	C-200	6
680					C-400	4	C-200	5
820							C-400	6
1000							C-400	5
1200							C-400	4

□ Class I Dielectrics ■ Class II Dielectrics



CR/CM Series — Row Capacitors

Row capacitors are used where arrays of capacitors (not necessarily identical) are needed, usually for decoupling/bypass of GaAs integrated circuits. Standard arrays can contain up to 10 capacitors from 0.04pF on up. Typical overall dimensions range from 20 x 10 mils on up. Parts can be fully customized to meet the requirements of your application to provide the shortest lead length possible.

DESCRIPTION

Row caps (CR) are also available with margins (CM) surrounding the edges to help prevent epoxy shorts and aid optical recognition systems.

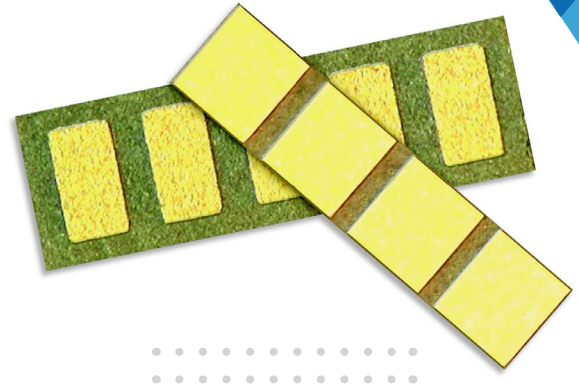

CR/CM STANDARD CAPACITANCE TOLERANCE CODES

Class I Dielectrics: C-20 thru C-NR

Tolerance	Code
± 20%	M
± 15%	L
± 10%	K

Class II Dielectrics: C-80 thru C-400

Tolerance	Code	Tolerance	Code
-10% thru +40%	Y	± 20%	M
-20% thru +80%	Z	± 15%	L
-0% thru +100%	V	± 10%	K
Guaranteed Min. Value	GMV		

CR6 CHIP DIMENSIONS

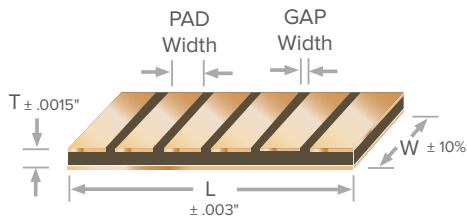

CR/CM ELECTRODE CONFIGURATION

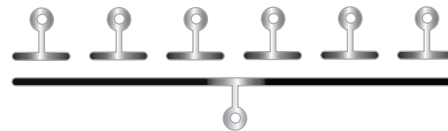

ORDERING INFORMATION — CR/CM SERIES — ROW CAPACITORS

CR	6	130	105 x 25	x 4	5	G	101	Z
Cap Style	No. of Caps	Dielectric Type	Length x Width (mils)	Thickness (mils)	Gap (mils)	Metallization	Capacitance (pF)	Capacitance Tolerance
CR = Row CM = Margin	-	See Class I and Class II tables (page 26)	See CR/CM Chip Dimensions (at right)	See CR/CM Chip Dimensions (at right)		G = Gold Custom	First two digits represent significant figures and the last, the number of zeros to follow. When required, the letter "R" is used as a decimal point and the succeeding digits represent significant figures only. e.g.: 101 = 100pF, 1R6 = 1.6pF	See CR/CM Standard Capacitance Tolerance Codes (below)

Note: Example shown: Complex Series CR, dielectric type C-BN, .105" x .025", gold, 100pF, +80 to -20% tolerance, 6 cap. chip

Please contact factory to request free samples.

CR/CM Series — Row Capacitors

CR/CM SELECTION CHART

Note: Selection Chart is for guidance only. The square area and capacitance parameters are for a single pad. All Compex parts are built to specific customer requirements.

Capacitor Size in Mils (mm)

Cap. (pF)	10x10 (.254x.254)		12x12 (.305x.305)		15x15 (.381x.381)		20x20 (.508x.508)		25x25 (.635x.635)		30x30 (.762x.762)		35x35 (.889x.889)		40x40 (1.016x1.016)		50x50 (1.27x1.27)					
	Diel.	Thick.	Diel.	Thick.	Diel.	Thick.	Diel.	Thick.	Diel.	Thick.	Diel.	Thick.	Diel.	Thick.	Diel.	Thick.	Diel.	Thick.				
0.04	C-30	5	C-30	6	C-30	10									Class I Dielectrics							
0.06	C-30	4	C-30	5	C-30	8	C-20	5	C-20	10												
0.08	C-50	10	C-30	4	C-30	6	C-30	10	C-20	7	C-20	9										
0.1	C-50	8	C-50	11	C-30	5	C-30	9	C-20	5	C-20	7	C-20	10								
0.2	C-50	5	C-50	7	C-50	10	C-30	4	C-30	7	C-30	10	C-20	5	C-20	7	C-20	10				
0.3	C-58	6	C-50	4	C-50	6	C-50	11	C-30	4	C-30	7	C-30	9	C-20	5	C-20	7				
0.4	C-58	5	C-58	7	C-50	5	C-50	9	C-50	15	C-30	5	C-30	7	C-30	9	C-20	5				
0.5	C-58	4	C-58	5	C-50	4	C-50	7	C-50	11	C-30	5	C-30	5	C-30	7	C-20	4				
0.6	C-NR	6	C-58	5	C-58	7	C-50	6	C-50	10	C-50	15	C-30	4	C-30	6	C-30	9				
0.8	C-80	8	C-NR	6	C-58	5	C-50	5	C-50	7	C-50	10	C-50	15	C-30	4	C-30	7				
1	C-80	7	C-NR	5	C-58	4	C-58	7	C-50	6	C-50	8	C-50	10	C-30	4	C-30	5				
1.2	C-80	6	C-NR	4	C-58	4	C-58	6	C-50	5	C-50	7	C-50	9	C-30	3	C-30	5				
1.5	C-80	5	C-80	7	C-NR	5	C-58	5	C-50	4	C-50	6	C-50	7	C-50	10	C-30	4				
1.8	C-80	4	C-80	5	C-NR	4	C-58	4	C-58	6	C-50	5	C-50	6	C-50	8	C-50	11				
2	C-80	4	C-80	5	C-NR	4	C-NR	7	C-58	6	C-50	4	C-50	5	C-50	7	C-50	11				
2.2	C-BD/ BE	4	C-80	5	C-NR	4	C-NR	6	C-58	5	C-58	7	C-50	5	C-50	7	C-50	10				
2.7	C-BD/ BE	8	C-80	4	C-80	6	C-NR	5	C-58	4	C-58	6	C-50	4	C-50	5	C-50	8				
3.3	C-BD/ BE	7	C-BD/ BE	10	C-80	5	C-NR	4	C-NR	6	C-58	5	C-58	7	C-50	4	C-50	7				
3.9	C-BD/ BE	6	C-BD/ BE	9	C-80	4	C-80	7	C-NR	5	C-58	4	C-58	6	C-58	8	C-50	6				
4.7	C-BD/ BE	5	C-BD/ BE	7	C-BD/ BE	11	C-80	6	C-NR	4	C-NR	6	C-58	5	C-58	6	C-50	5				
5.6	C-BD/ BE	4	C-BD/ BE	6	C-BD/ BE	10	C-80	5	C-80	7	C-NR	5	C-58	4	C-58	5	C-50	4				
6.8	C-BD/ BE	4	C-BD/ BE	5	C-BD/ BE	8	C-80	4	C-80	6	C-NR	5	C-NR	6	C-58	4	C-58	7				
8.2	C-100	6	C-BD/ BE	4	C-BD/ BE	7	C-80	4	C-80	5	C-NR	4	C-NR	5	C-NR	7	C-NR	10				
10	C-100	5	C-BD/ BE	4	C-BD/ BE	5	C-BD/ BE	9	C-80	4	C-80	6	C-NR	4	C-NR	5	C-NR	8				
12	C-100	4	C-100	6	C-BD/ BE	5	C-BD/ BE	8	C-BD/ BE	11	C-80	5	C-80	7	C-NR	4	C-NR	7				
15	C-120	6	C-100	5	C-BD/ BE	4	C-BD/ BE	6	C-BD/ BE	10	C-80	4	C-80	6	C-80	7	C-NR	6				
18	C-120	5	C-100	4	C-100	6	C-BD/ BE	5	C-BD/ BE	8	C-BD/ BE	11	C-80	4	C-80	6	C-NR	5				
20	C-120	5	C-100	4	C-100	6	C-BD/ BE	5	C-BD/ BE	8	C-BD/ BE	11	C-80	4	C-80	5	C-NR	4				



CR/CM Series — Row Capacitors

CONTINUED

Capacitor Size in Mils (mm)

Cap. (pF)	10x10 (.254x.254)		12x12 (.305x.305)		15x15 (.381x.381)		20x20 (.508x.508)		25x25 (.635x.635)		30x30 (.762x.762)		35x35 (.889x.889)		40x40 (1.016x1.016)		50x50 (1.27x1.27)					
	Diel.	Thick.	Diel.	Thick.	Diel.	Thick.	Diel.	Thick.	Diel.	Thick.	Diel.	Thick.	Diel.	Thick.	Diel.	Thick.	Diel.	Thick.				
22	C-120	4	C-120	6	C-100	5	C-BD/BE	4	C-BD/BE	7	C-BD/BE	9	C-80	4	C-80	5	C-NR	4				
27	C-120	4	C-120	5	C-100	4	C-BD/BE	4	C-BD/BE	6	C-BD/BE	8	C-80	3	C-80	4	C-80	6				
33	C-BN	4	C-120	4	C-120	6	C-100	6	C-BD/BE	5	C-BD/BE	6	C-BD/BE	11	C-80	4	C-80	5				
39	C-140	6	C-120	4	C-120	5	C-100	5	C-BD/BE	4	C-BD/BE	5	C-BD/BE	7	C-BD/BE	10	C-80	4				
47	C-140	5	C-140	7	C-120	5	C-100	4	C-100	6	C-BD/BE	5	C-BD/BE	6	C-BD/BE	8	C-80	4				
56	C-140	4	C-140	6	C-BN	5	C-120	7	C-100	5	C-BD/BE	4	C-BD/BE	5	C-BD/BE	7	C-BD/BE	10				
68	C-140	4	C-140	5	C-BN	4	C-120	6	C-100	5	C-100	6	C-BD/BE	4	C-BD/BE	6	C-BD/BE	9				
82	C-200	7	C-140	4	C-140	7	C-BN	6	C-100	4	C-100	5	C-100	7	C-100	10	C-BD/BE	7				
100	C-200	6	C-200	8	C-140	6	C-BN	5	C-120	6	C-100	5	C-100	6	C-100	8	C-BD/BE	6				
120	C-200	5	C-200	7	C-140	5	C-140	8	C-BN	6	C-100	4	C-100	5	C-100	7	C-BD/BE	5				
150	C-200	4	C-200	5	C-140	4	C-140	7	C-BN	5	C-BN	7	C-100	4	C-100	5	C-BD/BE	4				
180	C-400	4	C-200	5	C-200	7	C-140	6	C-BN	4	C-BN	6	C-BN	8	C-120	8	C-100	7				
200	C-400	4	C-200	4	C-200	6	C-140	5	C-140	8	C-BN	5	C-BN	7	C-120	7	C-100	6				
220	C-400	4	C-400	5	C-200	6	C-140	4	C-140	7	C-BN	5	C-BN	6	C-120	6	C-100	6				
270			C-400	4	C-200	5	C-200	8	C-140	6	C-BN	4	C-BN	5	C-120	5	C-100	5				
330					C-200	4	C-200	7	C-140	5	C-140	7	C-BN	4	C-120	4	C-120	7				
390					C-400	4	C-200	6	C-140	4	C-140	6	C-140	7	C-140	10	C-120	6				
470					C-400	4	C-200	5	C-200	7	C-140	5	C-140	6	C-140	8	C-120	5				
560							C-200	4	C-200	6	C-140	4	C-140	5	C-140	7	C-120	4				
680							C-400	5	C-200	5	C-200	8	C-140	5	C-140	6	C-BN	4				
820							C-400	4	C-400	6	C-200	6	C-140	4	C-140	5	C-140	7				
1000									C-400	5	C-200	5	C-200	7	C-140	4	C-140	6				
1200									C-400	4	C-200	4	C-200	6	C-200	7	C-140	5				
1500	Class II Dielectrics										C-400	5	C-200	5	C-200	6	C-140	4				
1800													C-400	4	C-400	6	C-200	5	C-200	8		
2200																C-400	5	C-200	4	C-200	6	
2700																	C-400	4	C-400	5	C-200	5
3300																					C-400	6



High-K Ceramic Substrates & Plates

High-K substrates are used for circuit miniaturization. DLI offers complete fabrication services.

CASE SIZES AND TOLERANCES

For custom sizes, please contact the sales office.

Case Size (Inches)	Length (Inches)	Width (Inches)	Plates (H) ±(Inches)	Substrates (S) ±(Inches)
10	1.000	1.000	Substrates Only	.002
15	1.000	1.500	.050	.002
20	2.000	2.000	.050	.002
25	2.500	2.500	.050	.002
30	3.000	3.000	.050	.002
40	4.000	4.000	.050	.002



MATERIAL SPECIFICATIONS

Material Code	Relative ϵ_R^* @ 5 GHz	TCC [†] Loss ppm/°C	Coefficient of Tangent* % Max	Thermal Expansion ppm/°K	Conductivity W/m-°K
QZ	3.82 (@ 1MHz)	Fused Quartz	0.0015 (@ 1MHz) 0.033 (@ 24 GHz)	0.55	1.28
AG	8.85 ± 0.35 (@ 1MHz)	Aluminum Nitride	0.10	4.6	140 - 180
PI	9.9 ± 0.15 (@ 1MHz)	Alumina 99.6%	0.01	6.5 - 7.5	27
PG	12.5 ± 0.5	P22 ± 30	0.02	7.6	-
AH	20 ± 0.5	P90 ± 20	0.02	9.6	1.56
NA	23 ± 1	N30 ± 15	0.03	10.1	1.56
CF	25 ± 2	0 ± 15	0.15	9.0	1.56
CD	38 ± 1	N20 ± 15	0.04	5.8	1.59
CG	67 ± 3	0 ± 30	0.10	9.0	1.59
NR	152 ± 5	N1500 ± 500	0.06	10.0	2.72

*Unless otherwise specified, K dielectric measurement at approximately 5 GHz. †For the temperature range -55 to 125°C.



High-K Ceramic Substrates & Plates

CONTINUED

METALLIZATION

Code	Description
X	No Metallization
M	300 Angstroms TiW, 100 μ in. min. Au
N	75 μ in. min. Nickel, 100 μ in. min. Au
P	300 Angstroms TiW, 50 μ in. min. NiV, 100 μ in. min. Au
L	Top 50 Ohms/sq. TaN, 300 Angstroms TiW, 100 μ in. min Au
	Bottom Side 300 Angstroms TiW, 100 μ in. min. Au
E	Metallized and etched per customer drawing
T	300 Angstroms min. TiW, 50 μ in. min. NiV, 300 μ in. min. Au-Sn
D	Special customer drawing required

SURFACE FINISH

Code	Roughness R	Material Process
X	>50μ in.	As-Fired
Y	20μ in.	Machined
Z	<5μ in.	Polished
S	Special customer drawing required	

SCREENING OPTIONS

Test Code	Test/Inspection	Sample Size	Description
X	Visual Mechanical	100%	Verify that the required area is available and continuous (Broken corners allowable).
K	Visual Mechanical	100%	Verify that the required area is available and continuous (Broken corners allowable).
	Kent Test	10% of hot	K and Loss.
D	Customer Defined	-	Special customer drawing required

ORDERING INFORMATION — THIN FILM — HIGH-K CERAMIC SUBSTRATES & PLATES

S	20	CG	250	D	Z	N	X
Product	Case Size	Material	Thickness	Thickness Tolerance	Surface Finish	Metallization	Test Level
S = Substrate H = Plate	10	See material table above.	100 = .010" 155 = .0155" 250 = .025"	D = ± .0005 E = ± .001 Thickness Tolerance Codes D = ± .0005 – Machined or Polished E = ± .001 – Standard	X Y Z S See table above.	See table above.	X K D See test level definitions on page 7.
	15		Thickness Code. A three-digit code representing the thickness in mils.				
	20		Examples:				
	25		Code 100 = .010",				
	30		Code 155 = .0155",				
	40		Code 250 = .025"				
		Please consult with an applications engineer for thicknesses < .010"					

SLC — Heatsinks, Standoffs & Submounts

HEATSINKS

- Heatsinks are fully metallized on all sides and are used to dissipate and absorb heat
- Heatsinks allow for high thermal conductivity and are electrically conductive (DC short)
- Typically used with LEDs or laser diodes

STANDOFFS

- A Standoff is much like a Heatsink; however it is typically metallized on only the top and bottom surfaces
- Each device is custom tailored to the customer's specifications and is typically used with LEDs or Photo Diodes (works as a photo detector, light is allowed in through fibers)

SUBMOUNTS

- Submounts are ceramic LED package bases that minimize thermal resistance between LED junctions and adjacent components
- By reducing junction temperatures, an LED will produce increased efficiency, brightness, color and reliability
- Each device is custom tailored to the customer's specifications

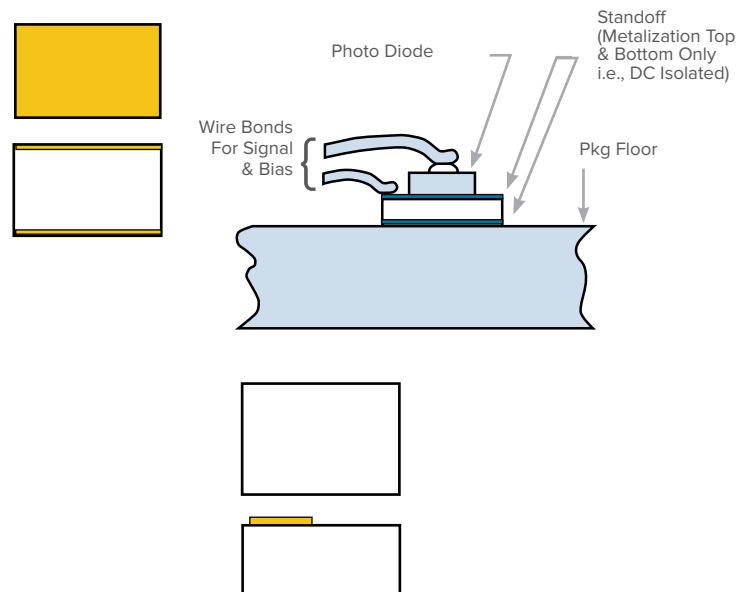
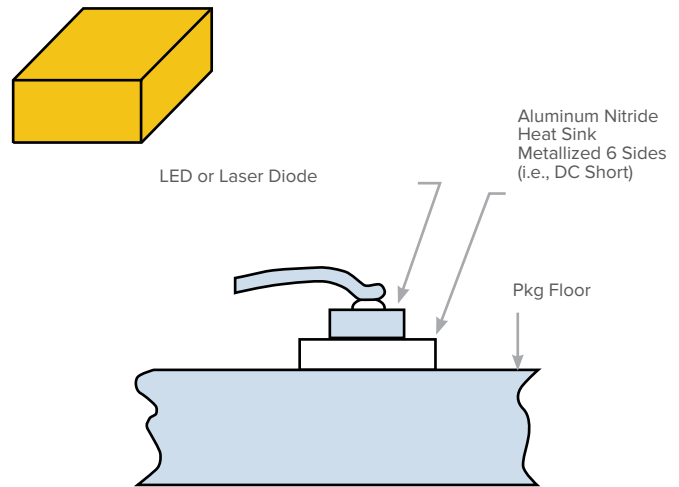

SLC — Heatsinks, Standoffs & Submounts

CONTINUED

MATERIAL SPECIFICATIONS

Material Code	Relative ϵ_R^* @ 5 GHz	TCC [†] Loss ppm/°C	Coefficient of Tangent* % Max	Thermal Expansion ppm/°K	Conductivity W/m-°K
AG	8.85 ± 0.35 (@ 1MHz)	Aluminum Nitride	0.10	4.6	140 - 180
PI	9.9 ± 0.15 (@ 1MHz)	Alumina 99.6%	0.01	6.5 - 7.5	27

*Unless otherwise specified, K dielectric measurement at approximately 5 GHz. †For the temperature range -55 to 125°C. **Material only provided metalized.

SURFACE FINISH

Code	Roughness R	Material Process
X	>50 μ in.	As-Fired
Y	20 μ in.	Machined
Z	<5 μ in.	Polished
S	Special customer drawing required	

METALLIZATION

Code	Description
M	300 Angstroms TiW, 100 μ in. min. Au
P	75 μ in. min. Nickel, 100 μ in. min. Au
E	Metallized and etched per customer drawing
T	300 Angstroms min. TiW, 50 μ in. min. NiV, 300 μ in. min. Au-Sn
D	Special customer drawing required



SBT Series — Submounts

Submount materials include quartz, alumina, aluminum nitride, kovar and beryllium oxide.

Applications include heat sinks, standoffs, height matching, bonding pads and jumpers.

Custom sizes, patterns and shapes are available to your design specifications in thicknesses from 3 to 100 mils and beyond.



SUBMOUNT MATERIAL PROPERTIES CHART

	Quartz	Alumina	AlN	Kovar	BeO	Si
Material Code	C-20	C-30/35	C-28	KVR	C-25	C-22
Coefficient of Thermal Expansion (ppm/°C)	6	6.7	4.6	5.86	7.5	0.56
Thermal Conductivity (W/m-k)	1.6	26	170	17.3	270	1.38 (SiO ₂)

ORDERING INFORMATION — SBT SERIES — SUBMOUNTS

SBT	28	20 x 20	x 6	G	S	5
Cap Style	Material	Length x Width (mils)	Thickness (mils)	Metallization	Cut to Size	Thickness Tolerance
SBT = Edge-to-edge plated or bare CSX = Custom patterned	See Submount Material Properties Chart above	-	3 to +100 mils	G = Gold B = Bare Custom	-	(only utilized if <.001"; figure represents tenths of a mil)

Note: Standard dimensional tolerance is .001" for length, width, and thickness. Tighter Thickness tolerances down to .0002" are available.

Example: Complex Series SBT, dielectric type C-28, .020" x .020" x .006", gold, cut to size, .0005" thickness tolerance

[Kits available for design development](#)



MST Series — Mounting Shorts

Alumina mounting shorts (or Aluminum Nitride for improved thermal properties), with metallization on the top, bottom and two of four sides, allow placement of a wirebond anywhere in the circuit, replacing the need for gold terminations on the substrate. They also can be used to raise the ground plane, reducing lead length for reduced inductance for high-speed/frequency applications, or to dissipate heat from under an IC or laser chip.

DESCRIPTION

- Instant bonding pads
- Fully conductive
- Height matching
- Replaces moly-tabs
- Any size available, as small as .00003" x .0003"

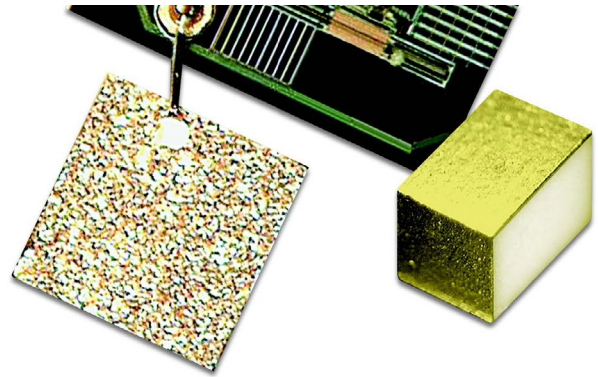

MST CHIP DIMENSIONS



Dimensional Tolerance: Standard is .001" for length, width and thickness. Tighter tolerances down to .0003" are available for thickness .0005" and greater.

For <.0005", consult factory for available tolerances.

WIREBOND

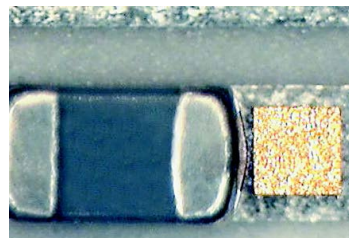

RAISED PLANE

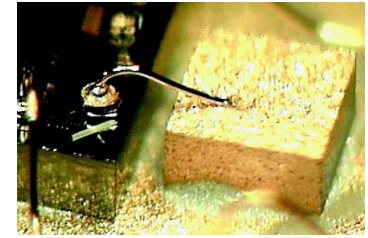

Our ceramic mounting shorts are excellent replacements for kovar and moly-tabs. These ceramic shorts have a much sharper edge and are flat stable bases for mounting semiconductors.

ORDERING INFORMATION — MST SERIES — MOUNTING SHORTS

MST	30	25	x 20	x 6	G	S	5
Cap Style	Material	Length (mils)	Width (unmetallized side) (mils)	Thickness (mils)	Metallization	Cut to Size	Thickness Tolerance
-	-	-	-	3 to +100 mils G = Gold	G = Gold Custom	-	(only utilized if <.001"; figure represents tenths of a mil)

Example Shown: Complex Series MST, dielectric type C-30, .025" x .020" x .006", gold, cut to size, .0005" thickness tolerance

[Kits available for design development](#)



Milli-Cap[®] — Ideal SMT Capacitor

FEATURES

- 0201, 0402 and 0602 Footprints
- Very Low Series Inductance
- Matches Typical 50Ω Line Widths
- Single-Piece Construction
- Low Loss High Q parts
- Ultra High Series Resonance
- Behaves Like an Ideal Capacitor
- Orientation Insensitive

FUNCTIONAL APPLICATIONS

- Test Equipment, Photonics, SONET, TOSA/ROSA, High-Speed Data
- Broadband Microwave/Millimeter Wave
- Transimpedance Amplifiers



SPECIFICATIONS — MILLI-CAP[®]

Electrical

Temperature Coefficient of Capacitance	Electrical Characteristics Table
Milli-Cap [®] Metallization	7.5μ" Au over 50μ" Ni
Capacitance Range	0.5pF to 82pF
Maximum Assembly Process Temperature	250°C

P21

Insertion Loss

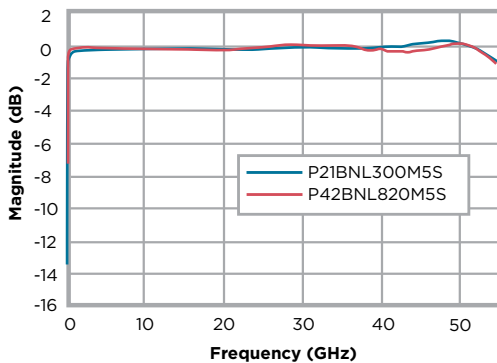

P62

Insertion Loss

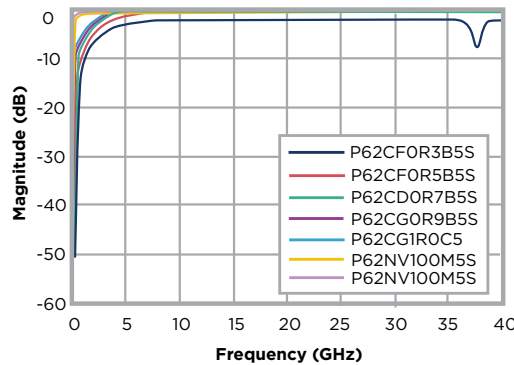

P42

Insertion Loss

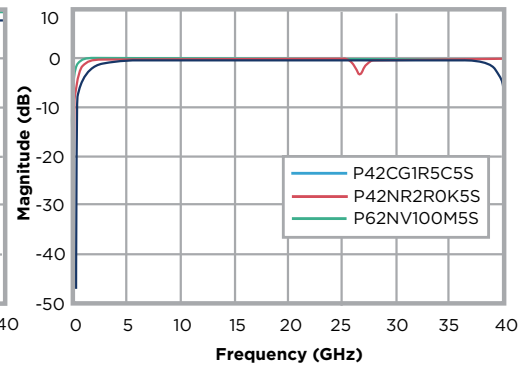

Milli-Cap® — Ideal SMT Capacitor

ELECTRICAL CHARACTERISTICS — MILLI-CAP®

Part Number	Value (pF)	Voltage Rating	TCC	Dissipation Factor (Max)	Insulation Resistance (Min)	Frequency Range
P21BNL300M5S	30	50	± 15%	3.5%	10 ⁵ MΩ	20MHz – 50GHz
P42BNL820M5S	82	50	± 15%	3.5%	10 ⁵ MΩ	20MHz – 50GHz
P42NR2R0K5S	2	50	N1500 ± 500ppm/°C	0.25%	10 ⁶ MΩ	4GHz – 20GHz
P42CG1R5C5S	1.5	50	0 ± 30ppm/°C	0.7%	10 ⁶ MΩ	8GHz – 32GHz
P62BNL820M5S	82	50	± 15%	3.5%	10 ⁵ MΩ	20MHz – 50GHz
P62NV100M5S	10	50	N4700 ± 1000ppm/°C	1.2%	10 ⁶ MΩ	4GHz – 20GHz
P62CG1R0C5S	1	50	0 ± 30ppm/°C	0.7%	10 ⁶ MΩ	18GHz – 40GHz
P62CD0R7B5S	0.7	50	N20 ± 15ppm/°C	0.15%	10 ⁶ MΩ	20GHz – 40GHz
P62CF0R5B5S	0.5	50	0 ± 15 ppm/°C	0.6%	10 ⁶ MΩ	28GHz – 40GHz

DIMENSIONAL SPECIFICATIONS — MILLI-CAP®

Case Size	Length	Milli-Cap® Width	Thickness
P21 (0201)	0.020" ± 0.004"	0.012" ± 0.002"	0.010" ± 0.002
P42 (0402)	0.038" ± 0.004"	0.020" ± 0.002"	0.020" ± 0.002"
P62 (0602)	0.058" ± 0.004"	0.020" ± 0.002"	0.020" ± 0.002"

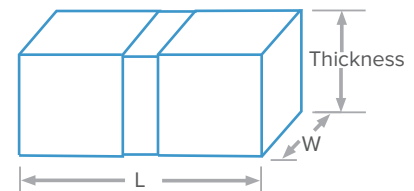

ATTACHMENT METHODS — MILLI-CAP®

Recommended attachment to soft or hard substrate using Conductive Epoxy

1. Place a single drop of conductive epoxy onto each microstrip as illustrated; the edge of the epoxy shall be at least .003"-.004" back from the edge of the trace to prevent filling the gap with epoxy.
2. Centering the termination gap of the capacitor within the gap in the microstrip, press with careful, even pressure onto the microstrip ensuring the terminations make good contact with the epoxy drops.
3. Cure according to the epoxy manufacturer's preferred schedule, typically 125°C to 150°C max.
4. After curing, inspect joint for epoxy shorts across the termination and microstrip gaps that would cause a short across the cap. Isopropanol and Methanol are both safe to use to pre-clean Milli-Caps®. Isopropanol and Methanol are not to be used after mounting with conductive epoxy as they act as a solvent.

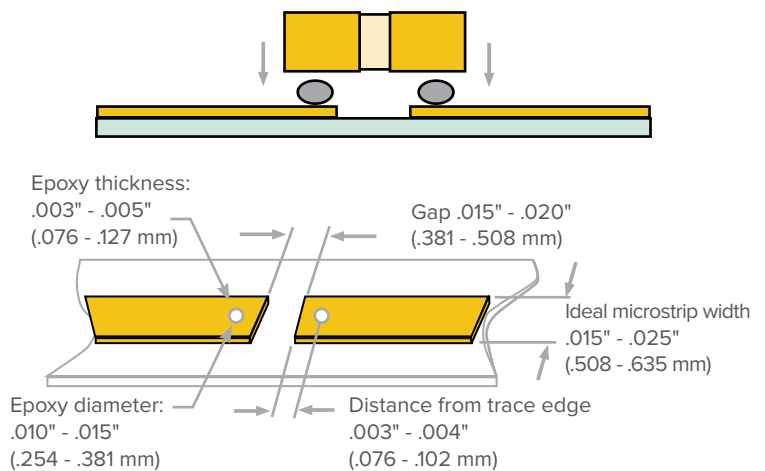

Recommended attachment to soft or hard substrate using Solder

1. Place a single drop of solder paste onto each micro strip as illustrated; the edge of the solder shall be at least .001"-.002" back from the edge of the trace to prevent filling the gap with solder.
2. Centering the termination gap of the capacitor within the gap in the microstrip, press with careful, even pressure onto the microstrip ensuring the terminations make good contact with the drops of solder paste.

3. Reflow according to the solder manufacturer's preferred profile, ensuring the reflow temperature does not exceed 250°C.
 4. After the reflow step is completed, inspect joint for voids or excess flux and non-reflowed solder balls that can degrade performance or cause shorts across the gaps. Proper cleaning after the reflow process is crucial to avoiding performance degradation and discovering poor solder joints.
- Isopropanol and Methanol are both safe to use with soldered Milli-Caps®.



Opti-Cap® — Ultra Broadband DC Blocking

FEATURES

- X7R temperature and voltage stability
- Resonance free DC blocking to >40GHz
- SMT by solder or epoxy bonding
- Low frequency stability over temperature
- Very low series inductance
- 0201, 0402 and 0602 footprints

FUNCTIONAL APPLICATIONS

- Test Equipment, Photonics, SONET, TOSA/ROSA, High-Speed Data
- Broadband Microwave/Millimeter Wave
- Transimpedance Amplifiers

BENEFITS

- Eliminates wire bonding
- Coplanar waveguide
- Low insertion loss



SPECIFICATIONS — OPTI-CAP®

Electrical	
Temperature Coefficient of Capacitance	X5R: -55°C to +85°C (TCC ± 15%) X7R: -55°C to +125°C (TCC ± 15%)
Capacitance Range	1.5nF to 220nF
Maximum Assembly Process Temperature	250°C

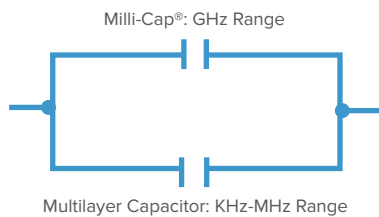

INSERTION LOSS

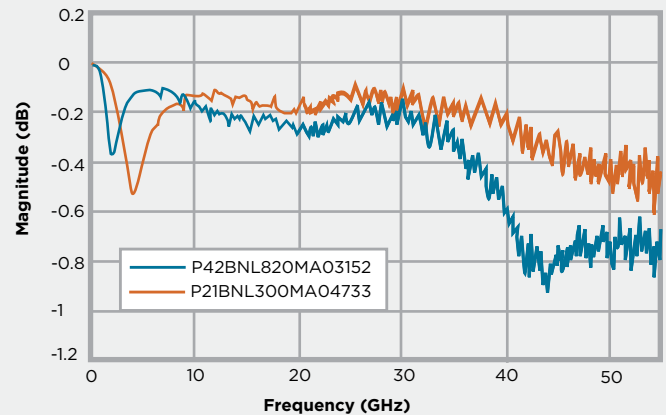

ELECTRICAL CHARACTERISTICS — OPTI-CAP®

Part Number	Capacitance		Voltage Rating	TCC	DF (MAX)	IR (MIN)	Frequency Range
	MLC	Milli-Cap®					
P21BNL300MA04733	100nF	30pF	10V	X5R	3.5%	>10 ² MΩ	16KHz - >40GHz
P21BNL300MA04282	22nF	30pF					
P21BNL300MA03976	10nF	30pF					
P21BNL300MA04678	1.5nF	30pF	25V	X7R			
P42BNL820MA03152	220nF	82pF	10V	X5R			
P42BNL820MA04679	22nF	82pF	50V	X7R			
P62BNL820MA02636	100nF	82pF	25V	X7R			



Opti-Cap[®] — Ultra Broadband DC Blocking

DIMENSIONAL SPECIFICATIONS — OPTI-CAP[®]

Case Size	Opti-Cap [®]			MLC		
	Length	Width	Thickness	Length	Width	Thickness
P21 (0201)	0.020" ± 0.004"	0.012" ± 0.002"	0.010" ± 0.002"	0.022" ± 0.002"	0.010" ± 0.001"	0.010" ± 0.002"
P42 (0402)	0.038" ± 0.004"	0.020" ± 0.002"	0.020" ± 0.002"	0.040" ± 0.002"	0.020" ± 0.002"	0.020" ± 0.002"
P62 (0602)	0.058" ± 0.004"	0.020" ± 0.002"	0.020" ± 0.002"	0.067" ± 0.004"	0.031" ± 0.004"	0.031" ± 0.005"

ATTACHMENT METHODS — OPTI-CAP[®]

Recommended attachment to soft or hard substrate using Conductive Epoxy

1. Place a single drop of conductive epoxy onto each microstrip as illustrated; the edge of the epoxy shall be at least .003"-.004" back from the edge of the trace to prevent filling the gap with epoxy.
2. Centering the termination gap of the capacitor within the gap in the microstrip, press with careful, even pressure onto the microstrip ensuring the terminations make good contact with the epoxy drops.
3. Cure according to the epoxy manufacturer's preferred schedule, typically 125°C to 150°C max.
4. After curing, inspect joint for epoxy shorts across the termination and microstrip gaps that would cause a short across the cap.

Isopropanol and Methanol are both safe to use to pre-clean Opti-Caps[®], Isopropanol, and Methanol are not to be used after mounting with conductive epoxy as they act as a solvent!

Recommended attachment to soft or hard substrate using Solder

1. Place a single drop of solder paste onto each microstrip as illustrated; the edge of the solder shall be at least .001"-.002" back from the edge of the trace to prevent filling the gap with solder.
2. Centering the termination gap of the capacitor within the gap in the microstrip, press with careful, even pressure onto the microstrip ensuring the terminations make good contact with the drops of solder paste.

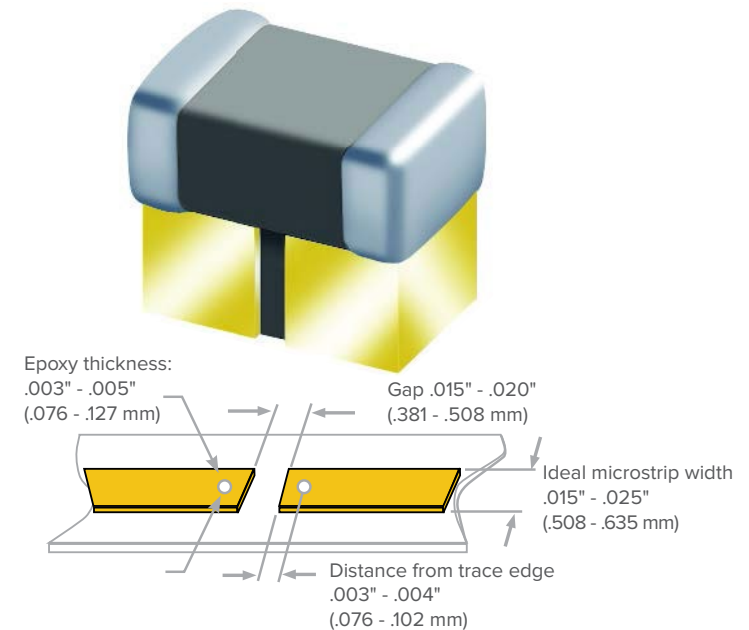

3. Reflow according to the solder manufacturer's preferred profile, ensuring the reflow temperature does not exceed 250°C.
4. After the reflow step is completed, inspect joint for voids or excess flux and non-reflowed solder balls that can degrade performance or cause shorts across the gaps. Proper cleaning after the reflow process is crucial to avoiding performance degradation and discovering poor solder joints.

Isopropanol and Methanol are both safe to use with soldered Opti-Caps[®].

PX Series — Broadband Blocking Device

FEATURES

- X7R temperature and voltage stability
- Low frequency stability
- Low insertion Loss
- Solder or epoxy attachment

FUNCTIONAL APPLICATIONS

- Broadband Microwave/Millimeter Wave
- Test Equipment
- ROSA/TOSA
- SONET



SPECIFICATIONS — PX SERIES

Electrical

Temperature Coefficient of Capacitance	SLC: 120pF Guaranteed Minimum Value (GMV) MLC: 100nF ±10%
Voltage	16WVDC
Dissipation Factor	3.0% @ 1MHz
Insulation Resistance	>103 MΩ
Assembly Process Temperature	250°C

Part Number	Metallization
PX42UX104KCZX	Sn (200μ") / Ni (150-250μ")
PX42UX104KCSX	Au (5-15μ") / Ni (150-250μ")
Packaging	(T) Tape & Reel - (W) Waffle Pack

Mechanical

Pressure force	>2.5N (min)
----------------	-------------

TYPICAL INSERTION LOSS (S11)

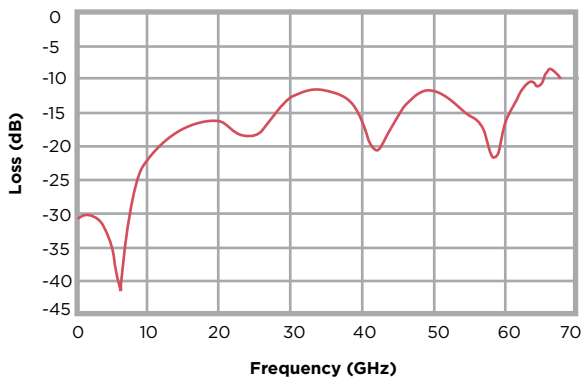

TYPICAL INSERTION LOSS (S21)

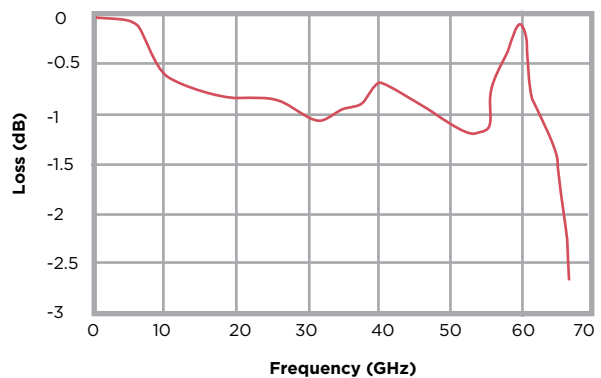

PX Series — Broadband Blocking Device

DIMENSIONS - PX SERIES BROADBAND BLOCKING DEVICE

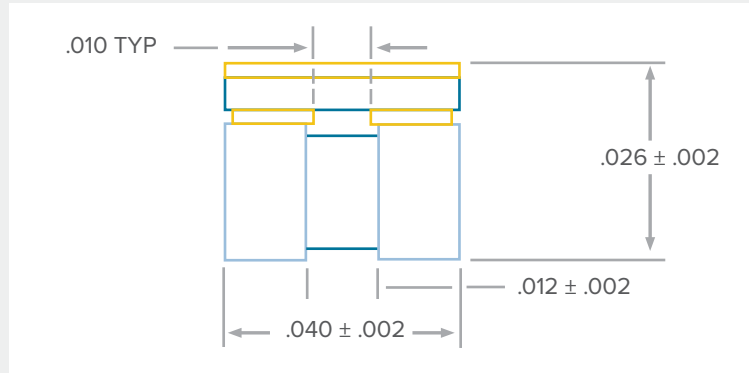

ATTACHMENT METHODS — PX SERIES — BROADBAND BLOCKING DEVICE

Recommended attachment to soft or hard substrate using Solder: Recommended Microstrip Layout:

1. Place a single drop of solder paste onto each microstrip as illustrated; the edge of the solder shall be at least $.001$ "- $.002$ " back from the edge of the trace to prevent filling the gap with solder.
2. Centering the termination gap of the capacitor within the gap in the microstrip, press with careful, even pressure onto the microstrip ensuring the terminations make good contact with the drops of solder paste.
3. Reflow according to the solder manufacturer's preferred profile, ensuring the reflow temperature does not exceed 260°C .
4. After the reflow step is completed, inspect joint for voids or excess flux and non-reflowed solder balls that can degrade performance or cause shorts across the gaps. Proper cleaning after the reflow process is crucial to avoiding performance degradation and discovering poor solder joints.

Isopropanol and Methanol are both safe to use with soldered units.

Mounting

The part is designed for surface mounting using conventional reflow soldering techniques. In accordance with normal recommendations for ceramic MLCCs, hand soldering should be avoided as soldering irons could cause thermal damage or disconnections within the device. If rework or manual placing is necessary, then the use of a hot air pencil is recommended. Preheating the board can assist with manual soldering. Pb free compatible.

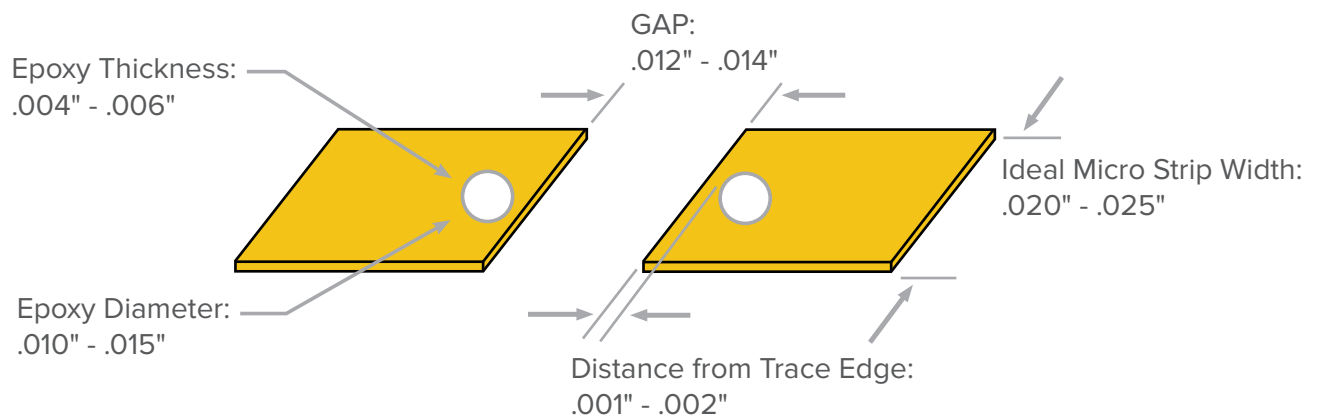

MLC — Broadband Blocks

DESCRIPTION

- Resonance free DC Blocking/Decoupling
- Less than 0.25 db loss @ 4 GHz (typical)
- Surface mountable

FUNCTIONAL APPLICATIONS

- Fiber Optic Links • High Isolation Decoupling • LANs, VCO Frequency Stabilization
- Diplexers • RF/Microwave Modules • Instruments • Test Equipments



MECHANICAL SPECIFICATIONS

Product Code	Lengths (L)	Body Dimensions		Band Dimensions	
		Width (W)	Thickness (T)	Min	Max
C04BL	0.040" ± 0.008"	0.020" ± 0.006"	0.028" Max	0.003"	0.019"
C06BL	0.060" ± 0.012"	0.031" ± 0.009"	0.036" Max	0.006"	0.03"
C08BL	0.081" ± 0.020"	0.051" ± 0.013"	0.061" Max	0.012"	0.0468"
C18BL	0.1200" ± 0.925"	0.1100" ± 0.010"	0.100" Max	0.008"	0.045"

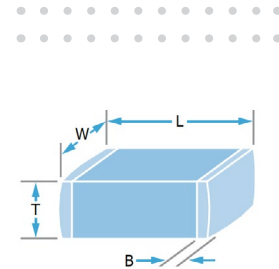

PART CHARACTERISTICS

Part Number	Capacitance Guaranteed Min Value	Voltage Rating	Temperature Coefficient -55°C to 125°C	Maximum Dissipation Factor	Insulation Resistance (MΩ Minimum)	Aging Rate	Frequency Range	Termination
C04BL121X-5UN-X0T	120pF @ 1KHz, 2Vrms	50 Vdc	± 15%	3.0% @ 1KHz, 2Vrms	10 ⁴	<=1.5%/decade hours	10MHz – 40GHz	"U" & "S"
C06BL851X-1UN-X0T	850pF @ 1KHz, 2Vrms	100 Vdc					2MHz – 30GHz	"U", "S" & "Z"
C08BL242X-5UN-X0T	2400pF @ 1KHz, 2Vrms	50 Vdc					1MHz – 20GHz	"U", "S" & "Z"
C08BL102X-1UN-X0T	1000pF @ 1KHz, 2Vrms	100 Vdc					1MHz – 20GHz "	"U", "S" & "Z"
C18BL103X-4UN-X0T	10,000pF @ 1KHz, 2Vrms	500 Vdc					1MHz – 6GHz "	"U", "S" & "Z"

PERFORMANCE

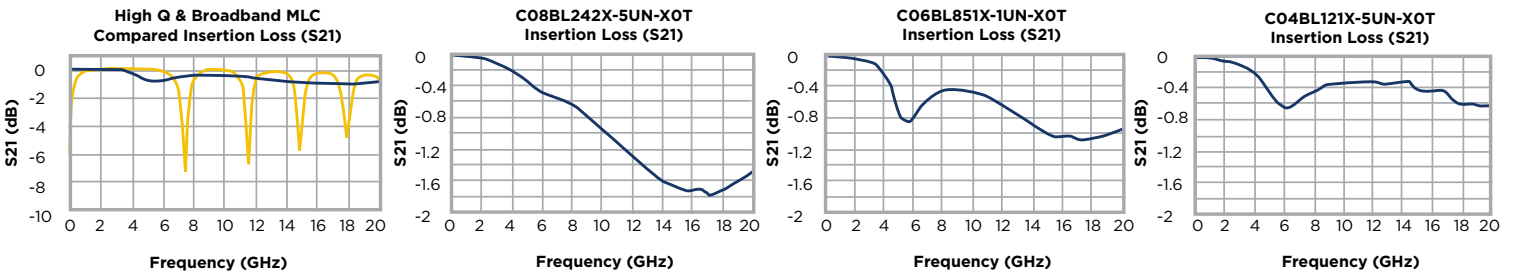

The information above represents typical device performance.

SLC — Gain Equalizers

SERIES OVERVIEW

The DLI brand of gain equalizers are designed to compensate for module gain slope. Excellent repeatable microwave performance is achieved by application of precision thin-film fabrication and high-permittivity ceramic materials. This unique design solution provides near ideal R-C frequency response that is far superior to "stacked R-C chip" assemblies.



DESIGN ADVANTAGES:

- Many designs smaller than 0402 case size
- Ease of integration
- Customization available

APPLICATIONS:

- Broadband Microwave modules: EW, ECM, ECCM
- Equalizer is utilized as a compensation circuit to correct for loss slope created by other circuit elements such as amplifiers

KEY CHARACTERISTICS:

- Superior microwave performance
- Reduced cost
- Flatten amplifier gain response
- Positive gain slope

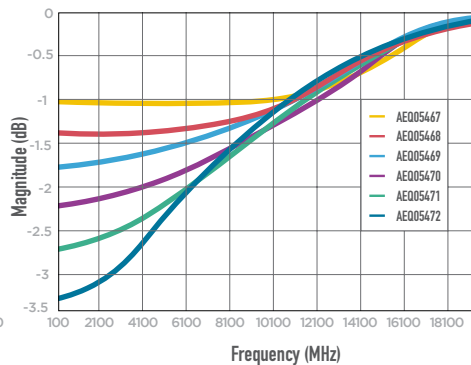
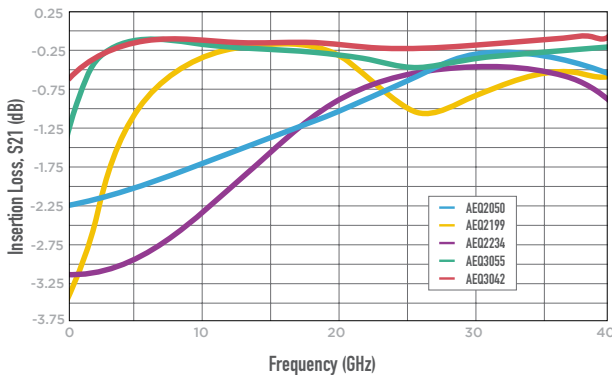

CERTIFICATION:



ORDERING INFORMATION:

Epoxy	Solderable	Lp	Wp	G	Nominal Slope	Length	Width	Thickness
AEQ2050	AEQ05510	9 ± 1	14 ± 1	8 ± 1	2.25 dB	30 ± 2	18 ± 2	5 ± 1
AEQ2199	AEQ05246	7 ± 1		12 ± 1	3.5 dB	28 ± 2	16 ± 2	7 ± 1
AEQ2234	AEQ06042	8 ± 1	12 ± 1	3 ± 1	3.25 dB	32 ± 1		20 ± 2
AEQ3042	AEQ3042	17.5 ± 1	17.5 ± 1		0.6 dB	40 ± 2	16 ± 1	
AEQ3055	AEQ3055	15.4 ± 1	18.4 ± 1	7.2 ± 1	1.5 dB			
AEQ05467	AEQ05467	7 min	14 ± 1	10	1.0 dB	28 ± 1	16 ± 1	7 ± 1
AEQ05468	AEQ05468				1.5 dB			
AEQ05469	AEQ05469				2.0 dB			
AEQ05470	AEQ05470				2.5 dB			
AEQ05471	AEQ05471				3.0 dB			
AEQ05472	AEQ05472				3.5 dB			



SLC — Gain Equalizers

GAIN EQUALIZER KIT

Knowles understands your needs for higher performance filters in smaller, lighter packages. Our Gain Equalizers offer gain slope compensation in a single component.

Benefits include:

- Superior microwave performance
- Excellent repeatability
- Ease of assembly
- Custom designs
- Small size (0402 or smaller)
- Products up through 40GHz



	AEQ02050	AEQ02199	AEQ02234	AEQ03055	AEQ03042
Low Freq. Loss	2.2dB	3.0dB	3.5dB	1.6dB	0.8dB
Min. Loss Freq.	31.0GHz	15.0GHz	27.0GHz	5.0GHz	5.0GHz
Mounting Method	Epoxy	Epoxy	Epoxy	Solder	Solder

EW GAIN EQUALIZER KIT

Knowles understands your needs for higher performance filters in smaller, lighter packages. Our Gain Equalizers offer gain slope compensation in a single component.

Benefits include:

- Superior microwave performance
- Excellent repeatability
- Ease of assembly
- Custom designs
- Small size (0402 or smaller)
- Products up through 40GHz



	AEQ05467	AEQ05468	AEQ05469	AEQ05470	AEQ05471	AEQ05472
Low Freq. Loss	1.0dB	1.35dB	1.75dB	2.25dB	2.75dB	3.25dB
Min. Loss Freq.	18GHz	18GHz	18GHz	18GHz	18GHz	18GHz
Mounting Method	Solder/Epoxy	Solder/Epoxy	Solder/Epoxy	Solder/Epoxy	Solder/Epoxy	Solder/Epoxy



Custom Thin Film: Integrated R-C Networks

C-R-C DECOUPLING NETWORKS (aka. RF Blocking Networks)

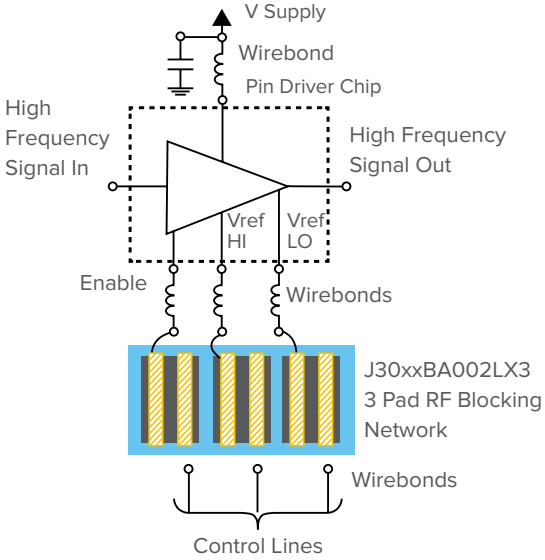

Segment Equivalent Schematic Representation

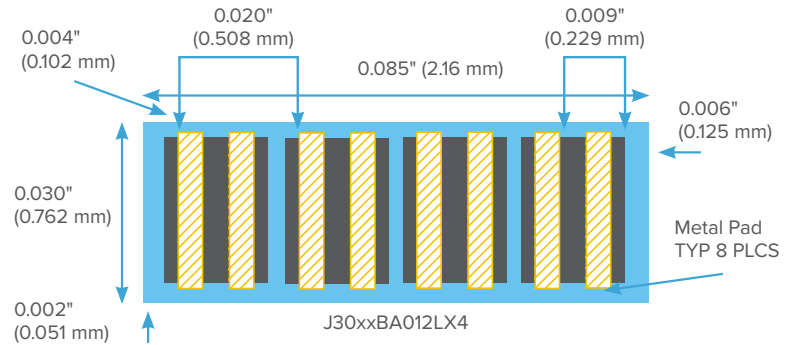
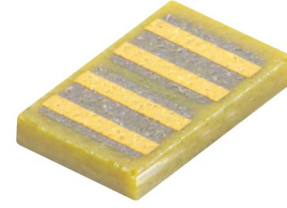
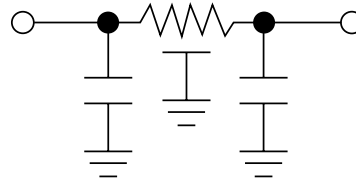

APPLICATIONS:

- Heatsinks and standoff
- Integrated passive components
- Custom resistor capacitor networks
- Large couplers, power combiners
- EMI filters
- High-frequency filters
- Microwave-integrated circuits (MIC)
- Bias decoupling and filtering
- Lumped element impedance matching network
- PA stabilization
- Impedance matching and power combining network

Part Number	J30BLBA032LX1	J30BLBA022LX2	J30BLBA002LX3	J30BLBA012LX4	J30BJBA032LX1	J30BJBA022LX2	J30BJBA002LX3	J30BJBA012LX4
Number of RC Segments	1	2	3	4	1	2	3	4
Nominal Resistance (pad to pad) (Ω)	10	10	10	10	10	10	10	10
Capacitance (typical) (pF)	30	30	30	30	45	45	45	45
Maximum DF	3.00%	3.00%	3.00%	3.00%	3.00%	3.00%	3.00%	3.00%
TCC	X7R	X7R	X7R	X7R	X7R	X7R	X7R	X7R
Rated Voltage (Vdc)	25	25	25	25	25	25	25	25
Attachment Method	All are configured for Chip & Wire attachment							
Termination Finish	100μinches Au, minimum							
Dimensions (inches)								
L	0.025	0.045	0.065	0.085	0.250	0.045	0.065	0.085
W	0.030	0.030	0.030	0.030	0.030	0.030	0.030	0.030
Dimensions (mm)								
L	0.64	1.14	1.65	2.16	6.35	1.14	1.65	2.16
W	0.76	0.76	0.76	0.76	0.76	0.76	0.76	0.76

Custom Thin Film: Integrated R-C Networks

CONTINUED

BIASED FILTER NETWORK SERIES OVERVIEW

DLI bandpass filters are designed for high-performance microwave applications in a surface mountable package. Using temperature-stable, high-permittivity dielectrics and thin-film processing, these designs offer high selectivity without sacrificing in-band performance.

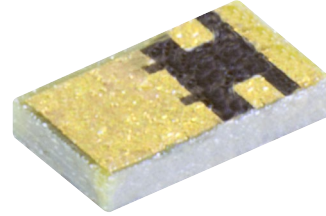

EQUIVALENT SCHEMATIC REPRESENTATION:

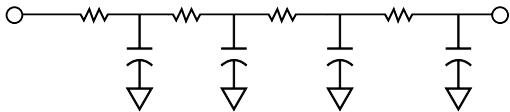

Part Number	Cap Range	Resist	Width	Length	Thickness
B20BHSBN01	40 to 90pF	100 ± 20%	.020 ± .001	.034 ± .001	.006 ± .001
B20BLSBN01	40 to 90pF	100 ± 20%	.020 ± .001	.034 ± .001	.006 ± .001
B28BHBFN01	76 to 171pF	600 ± 20%	.028 ± .001	.053 ± .001	.007 ± .001

SELF-BIASED NETWORK SERIES OVERVIEW

Knowles Precision Devices takes advantage of the high-permittivity ceramics offered by the DLI brand combined with thin-film resistors to provide a device that integrates source decoupling and user-selectable bias resistance.

The technique is commonly referred to as a self-biased GaAs FET amplifier – this enables the use of a single DC supply voltage. The gate is at DC ground potential and a negative V_{gs} is provided by the voltage drop across the wire bond selected resistors from source to ground – thus setting the desired drain bias current (I_{DS}).

The chip network is designed for epoxy attachment to a ground ridge, one on either side of an FET chip transistor. This provides symmetric, minimum reactance to ground source bypassing for optimum FET gain, by selectively wire bonding from resistor pads to ground. The pair of networks used for each FET provides a wide range of resistance combinations. The Self-Biased Networks, used as a pair replace two standard parallel plate capacitors and a separate set of bias resistors, reducing parts count, assembly and size.

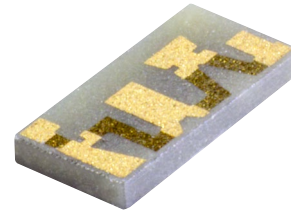

Part Number	Cap Range	Resist	Width	Length	Thickness
B28BJBFN01	76 to 171pF	600 ± 20%	.028 ± .001	.053 ± .001	.007 ± .001
B28BTBFN01	112 to 168pF	600 ± 20%	.028 ± .001	.053 ± .001	.007 ± .001



Our Other Products

- Air Capacitors
- Discoidal Capacitors
- EMI Filters
- Feedthrough EMI Filters
- Gain Equalizers
- Half-Turn Trimmers
- Hi-Cap Capacitors
- Hi-Rel Products
- Hi-Rel and Specialty Products
- Lead Capacitors
- Loaded Capacitors
- Opti-Cap® Capacitors
- Planar Arrays
- Pulse Capacitors
- Special Discrete Filters
- Special Filters
- Speciality Products
- Stacked Chips
- Trimmers
- Trimmer Capacitors
- Varistor Filters
- X8R Capacitors
- 250Vac Chips
- 500Vac X7R Chips

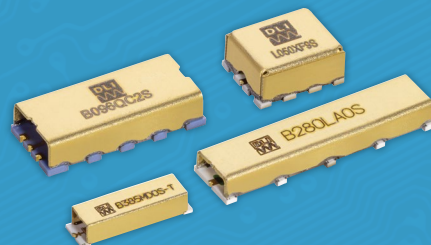



Asian Sales Office

O: +86 512 62588258

F: +86 512 62589258

KPD-Asia-sales@knowles.com

European Sales Office

O: +44 1603 723300

F: +44 1603 723301

KPD-Europe-sales@knowles.com

North American Sales Office

O: +1 661 295 5920

F: +1 661 295 5928

O: +1 315 655 8710

F: +1 315 655 0445

KPD-NA-sales@knowles.com

031821 R/5

X-ON Electronics

Largest Supplier of Electrical and Electronic Components

Click to view similar products for [Speciality Ceramic Capacitors](#) category:

Click to view products by [Knowles](#) manufacturer:

Other Similar products are found below :

[715CPP403CP571ZK02](#) [416462360](#) [275.546-505800](#) [715C15KTD19](#) [715C20KTD14](#) [715C30KTT94](#) [118FBB1R0B100TT](#) [CSM-50-40X40X4-G-3R3-D](#) [B58035U9504M052](#) [416461020](#) [416461150](#) [416463050](#) [416463100](#) [KJF-4.82/480](#) [KTF-1.5/400](#) [416461030](#) [416461050](#) [416461080](#) [416463260](#) [416464310](#) [416466150](#) [275.100-10180](#) [275.278-513700/221K02](#) [275.258-411000/221K02](#) [715C10DKS20](#) [116ZM103M050TT](#) [116RF100M100TT](#) [116RK101M100TT](#) [116UL102M100TT](#) [116TK221M100TT](#) [111TG101M100TT](#) [275.256-508300/221K02](#) [275.258-410000/221K02](#) [275.525-402800](#) [316523360](#) [316523370](#) [415047015](#) [415047018](#) [415047225](#) [416300564](#) [416303764](#) [416305664](#) [416461360](#) [416531100](#) [416533250](#) [416533300](#) [416533350](#) [416534250](#) [416463083](#) [275.288-614300/221K75](#)