

BGR 角形绕线电阻器 (玻璃芯)
Rectangular Type Wire wound Resistors With Glass Core

BWR 角形绕线电阻器 (陶瓷芯)
Rectangular Type Wire wound Resistors With Ceramic Core

BSR 角形金属氧化膜电阻器
Rectangular Type Metal Oxide Film Resistors

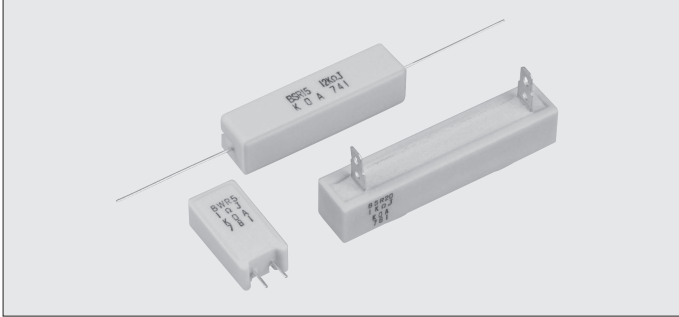

■ 负荷减轻特性曲线 Derating Curve

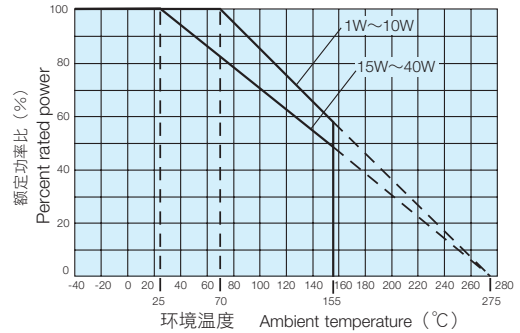

■ 额定值 Ratings

型号 Type	额定功率 Power Rating	电阻值范围 Resistance Range (Ω) E24				形状以及重量 Style & Weight (g/1pcs)														
		F: ±1%	G: ±2%	J: ±5%	K: ±10%	S	N	E	P	X	Y	YS	Z	H	Q	HA	HB	QA	QB	
BWR1	1W	1~56	0.22~75	0.1~75	-	1.3	-	-	-	-	-	-	-	-	-	-	-	-	-	-
BWR2	2W	1~160	0.22~200	0.1~200	-	2.1	3.9	-	-	-	-	-	-	-	-	-	-	-	-	-
BWR3	3W	1~300	0.22~390	0.1~390	-	3.9	5.9	-	-	-	-	-	-	-	-	-	-	-	-	-
BWR5	5W	1~300	0.22~390	0.1~390	-	5.1	7.2	5.7	5.6	-	-	-	-	-	-	-	-	-	-	-
BWR7	7W	1~360	0.22~390	0.1~390	-	7.5	10.8	-	-	-	-	-	-	-	-	-	-	-	-	-
BWR10	10W	1~390	0.22~390	0.1~390	-	10.2	15.0	-	-	-	-	-	-	-	-	-	-	-	-	-
BWR15	15W	1~390	0.22~390	0.1~390	-	18.8	-	-	-	-	-	-	-	-	-	-	-	-	-	-
BWR20	20W	1~390	0.22~390	0.1~390	-	23.3	-	-	-	-	-	-	-	-	-	-	-	-	-	-
BGR5	5W	-	-	10~390	0.39~9.1	-	-	-	-	6.1	7.6	6.6	7.6	-	-	-	-	-	-	-
BGR7	7W	-	-	10~390	0.39~9.1	-	-	-	-	8.2	9.1	7.8	9.1	-	-	-	-	-	-	-
BGR10	10W	-	-	10~390	0.39~9.1	-	-	-	-	11.0	12.4	10.4	11.4	9.9	-	13.6	-	-	-	-
BGR15	15W	-	-	10~390	0.51~9.1	-	-	-	-	18.8	-	-	20.5	18.4	18.6	24.4	27.5	24.6	27.7	-
BGR20	20W	-	-	10~390	0.51~9.1	-	-	-	-	22.3	-	-	24.0	21.9	22.1	27.9	31.0	28.1	31.3	-
BGR30	30W	-	-	10~390	2.2~9.1	-	-	-	-	-	-	-	-	59.3	59.6	73.9	73.5	74.2	73.8	-
BGR40	40W	-	-	10~390	2.2~9.1	-	-	-	-	-	-	-	-	70.4	70.6	85.0	84.6	85.2	84.8	-
BSR2	2W	-	-	430~13k	-	2.1	3.8	-	-	-	-	-	-	-	-	-	-	-	-	-
BSR3	3W	-	-	430~27k	-	3.9	5.9	-	-	-	-	-	-	-	-	-	-	-	-	-
BSR5	5W	-	-	430~39k	-	5.1	7.2	5.7	-	6.1	7.6	6.6	7.6	-	-	-	-	-	-	-
BSR7	7W	-	-	430~56k	-	7.4	10.8	-	-	8.2	9.1	7.8	9.1	-	-	-	-	-	-	-
BSR10	10W	-	-	430~75k	-	10.2	15.0	-	-	11.0	12.4	10.4	11.4	10.9	-	13.7	-	-	-	-
BSR15	15W	-	-	430~56k	-	18.8	-	-	-	18.5	-	-	20.5	18.4	18.6	24.4	27.5	24.6	27.7	-
BSR20	20W	-	-	430~56k	-	23.3	-	-	-	22.0	-	-	24.0	21.9	22.1	27.9	31.0	28.1	31.3	-

型号 Type	额定功率 Power Rating	额定周围温度 Rated Ambient Temp.	最高使用电压 (V) Max. Working Voltage		最高过载电压 (V) Max. Overload Voltage		电阻温度系数 T.C.R. (×10 ⁻⁶ /K)			使用温度范围 Operating Temp. Range
			BSR	BGR • BWR	BSR	BGR • BWR	BWR	BSR	BGR	
BWR1	1W	+70°C	-	E = √P • R	-	E = √P • R • 10	±100	±300	±250	-40°C ~ +155°C
BWR2	2W		250							
BWR3	3W		300							
BWR5	5W		350							
BWR7	7W		500							
BWR10	10W		700							
BWR15	15W		700							
BWR20	20W	750								
BGR30	30W	+25°C	-	-	-	-	-	-	-	
BGR40	40W		-	-	-	-	-	-	-	

额定电压是√额定功率×公称电阻值所算出的值或表中最高使用电压两者中小的值为额定电压。

Rated voltage = √Power Rating × Resistance value or Max. working voltage, whichever is lower.

关于定制产品请和我们事先咨询。

Please consult with us in advance about custom-made products.

■ 品名构成 Type Designation

实例 Example

BWR	3	C	N	100	J
品种 Product Code	额定功率 Power Rating	端子表面材料*1 Terminal Surface Material	形状*2 Style	公称电阻值 Nominal Resistance	阻值允许偏差 Resistance Tolerance
BGR: 玻璃芯卷线 Wire wound (Glass core) BWR: 陶瓷芯卷线 Wire wound (Ceramic core) BSR: 氧化金属膜 Metal oxide film	上述参照 See table above	C: SnCu T: Sn	空档: S style Nil: S style N: N style E: E style P: P style X: X style Y: Y style YS: YS style Z: Z style H: H style Q: Q style HA: HA style HB: HB style QA: QA style QB: QB style	F: 4 digits G, J, K: 3 digits	F: ±1% G: ±2% J: ±5% K: ±10%

※1 不含铅产品的记号。 Lead-Free plated terminal symbols. C (SnCu): N, E, S and P styles T (Sn): X, Y, YS, Z, H and Q styles

※2 对于S式样, 没有相应内容。 No indication on style means S style.

欲知关于此产品含有的环境有害物质详情(除EU-RoHS以外), 请与我们联系。

Contact us when you have control request for environmental hazardous material other than the substance specified by EU-RoHS.

High Power Type Resistors

■ 特点 Features

- 大功率型电阻器
- 陶瓷壳阻燃性 / 绝缘性电阻器
- 抗脉冲防止突入电流性能优异
- 端子无铅品, 符合欧盟RoHS。
- High-power resistor.
- Using flame-retardant/insulated ceramic case.
- Excellent in anti-pulse and inrush current.
- Products meet EU-RoHS requirements.

■ 外形尺寸 Dimensions

① S Style

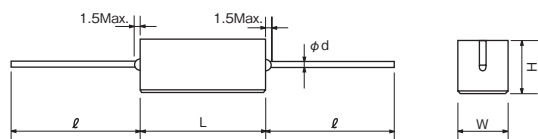

型号 Type	尺寸 Dimensions (mm)						
	L	W	H	$\phi \pm 3$	$d \pm 0.1$		
BWR1	13 \pm 1.0	5.5 \pm 1.0	5.5 \pm 1.0	30	0.6		
BWR2 · BSR2	18 \pm 1.5	6.3 \pm 1.0	6.3 \pm 1.0				
BWR3 · BSR3	22 \pm 1.5	8.0 \pm 1.0	8.0 \pm 1.0				
BWR5 · BSR5		9.5 \pm 1.0	9.5 \pm 1.0				
BWR7 · BSR7	48 \pm 1.5					12.5 \pm 1.2	12.5 \pm 1.2
BWR10 · BSR10							
BWR15 · BSR15	63.5 \pm 1.5	12.5 \pm 1.5	12.5 \pm 1.5				

② N Style

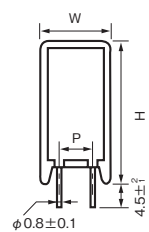

③ E Style

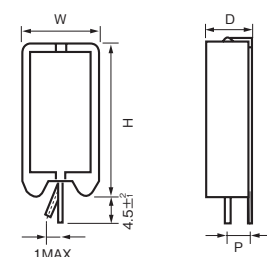

型号 Type	尺寸 Dimensions (mm)			
	W \pm 1	D \pm 1	H \pm 1.5	P \pm 2
BWR2N · BSR2N	11	7	20.5	5
BWR3N · BSR3N	12	8	25	
BWR5N · BSR5N	13	9	25.5	
BWR7N · BSR7N			38.5	
BWR10N · BSR10N	16	12	35	7.5
BWR5E · BSR5E	9.5	9.5	23.5	5

④ P Style

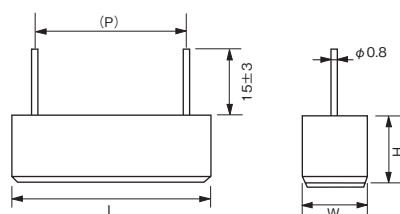

型号 Type	尺寸 Dimensions (mm)			
	L	W \pm 1.5	H \pm 1.5	(P)
BWR5P	23 \pm 1.5	9.5	9.5	20

() 内的尺寸为参考值。

Parenthesized dimensions are for reference.

请不要插入电路板中使用。

只对产品焊接, 产品会因外部受力而焊接强度不足, 所以请另外检讨其他固定方法。

Please refrain from using these parts as a board-insertion type.

Only soldering doesn't have enough joint strength.

Additional fixation is recommended.

⑤ X Style

(5W~10W)

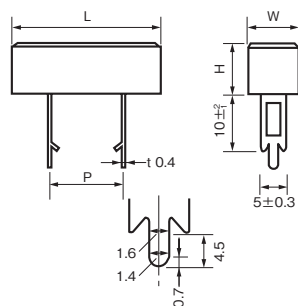

(15W, 20W)

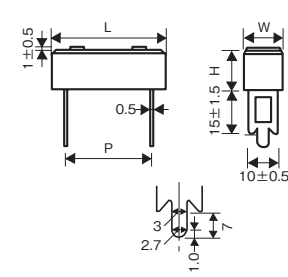

⑥ Y Style

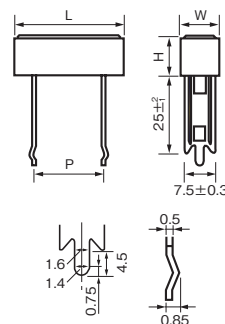

⑦ YS Style

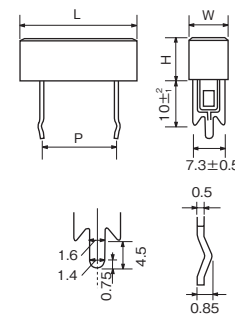

型号 Type	尺寸 Dimensions (mm)			
	L \pm 1.5	W \pm 1.0	H \pm 1.0	P \pm 1.5
BGR5X · BSR5X · BGR5Y · BSR5Y · BGR5YS · BSR5YS	27	9.5	9.5	15
BGR7X · BSR7X · BGR7Y · BSR7Y · BGR7YS · BSR7YS	35			22.5
BGR10X · BSR10X · BGR10Y · BSR10Y · BGR10YS · BSR10YS	48	12.5	12.5	35
BGR15X · BSR15X	63.5			32.5
BGR20X · BSR20X				47.5

POWER TYPE

■ 外形尺寸 Dimensions

⑧Z Style

(5W~10W)

(15W, 20W)

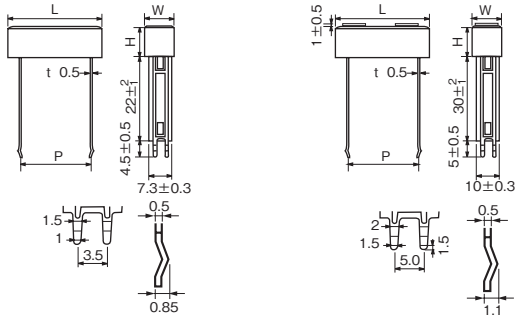

型号 Type	尺寸 Dimensions (mm)			
	L±1.5	W±1.0	H±1.0	P
BGR5Z · BSR5Z	27	9.5	9.5	15 ^{+0.6} ₋₀
BGR7Z · BSR7Z	35			22.5 ^{+0.6} ₋₀
BGR10Z · BSR10Z	48			35 ^{+0.6} ₋₀
BGR15Z · BSR15Z	63.5	12.5	12.5	32.5 ^{+0.4} ₋₀
BGR20Z · BSR20Z				47.5 ^{+0.4} ₋₀

⑨H Style

⑩Q Style

(15W, 20W)

(30W, 40W)

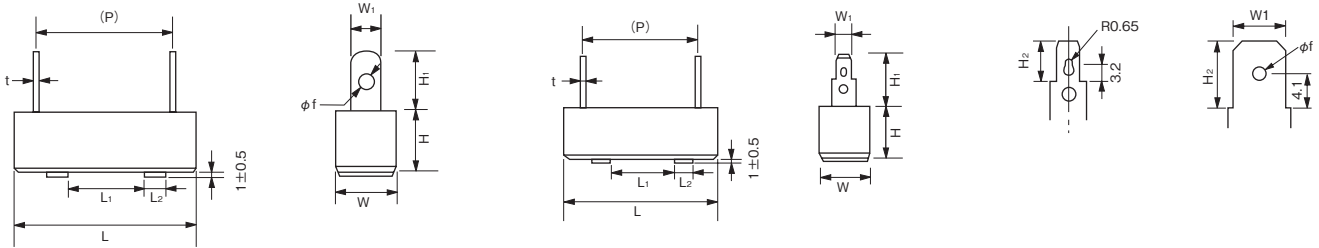

型号 Type	尺寸 Dimensions (mm)										
	L	L ₁	L ₂	W	W ₁	H	H ₁ ±1.0	H ₂	(P)	t	(φf)
BGR10H · BSR10H	48±1.5	25±1.0	4.5	9.5±1.0	5.0	9.5±1.0	7.0	—	35	0.4	2.0
BGR15H · BSR15H	63.5±2		7.0	12.5±1.2	6.0	12.5±1.5	8.5		34.5		
BGR20H · BSR20H	75±2.5		10.0	19.0±1.5	7.5	19.0±1.5	11.0		49.5		
BGR30H	90±2.5	40±1.2	10.0	19.0±1.5	7.5	19.0±1.5	11.0		56	0.5	3.0
BGR40H	90±2.5	40±1.2	10.0	19.0±1.5	7.5	19.0±1.5	11.0	71			
BGR15Q · BSR15Q	48±1.5	25±1.0	7.0	12.5±1.2	4.75	12.5±1.5	13.0	6.35	34.5	0.5	—
BGR20Q · BSR20Q	63.5±2		7.0	12.5±1.2	4.75	12.5±1.5	13.0		49.5		
BGR30Q	75±2.5		40±1.2	10.0	19.0±1.5	6.3	19.0±1.5	12.0	8.0	56	0.8
BGR40Q	90±2.5	40±1.2	10.0	19.0±1.5	6.3	19.0±1.5	12.0	71			

() 内的尺寸为参考值。Parenthesized dimensions are for reference.

⑪HA · QA Style

⑫HB · QB Style

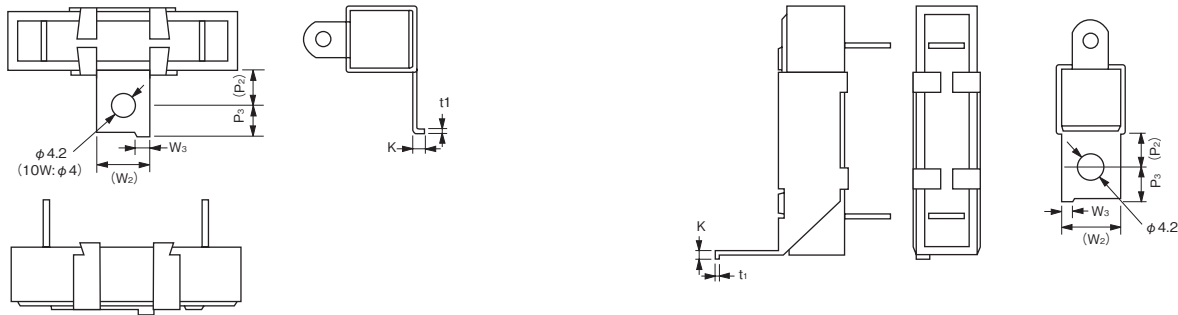

型号 Type	尺寸 Dimensions (mm)					
	(P ₂)	P ₃ ±1	(W ₂)	W ₃ ±0.3	K±0.3	t ₁
BGR10HA · BSR10HA	8.0	6	12	3.0	2.8	0.6
BGR15HA · BSR15HA · BGR15QA · BSR15QA						
BGR15HB · BSR15HB · BGR15QB · BSR15QB						
BGR20HA · BSR20HA · BGR20QA · BSR20QA						
BGR20HB · BSR20HB · BGR20QB · BSR20QB	10	8	18	3.0	3.0	0.8
BGR30HA · BGR30QA						
BGR30HB · BGR30QB						
BGR40HA · BGR40QA						
BGR40HB · BGR40QB						

() 内的尺寸为参考值。

Parenthesized dimensions are for reference.

■ 温度上升 Temperature Rise (Ref.)

①S Style

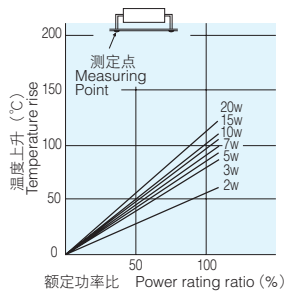
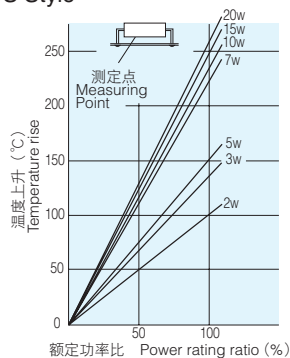

②N Style

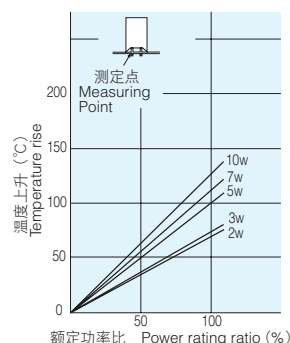

③E Style

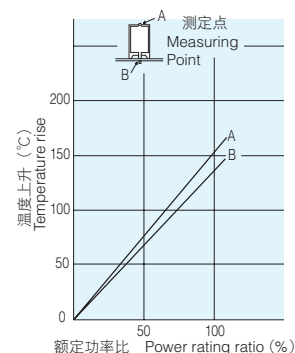

④X Style

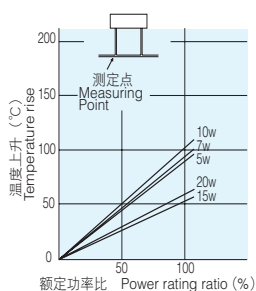

⑤Y Style

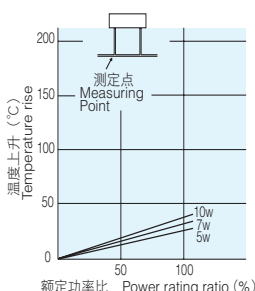

⑥YS Style

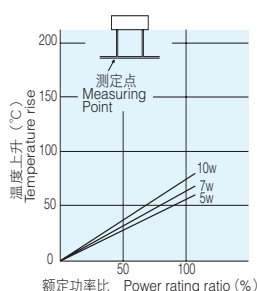

⑦Z Style

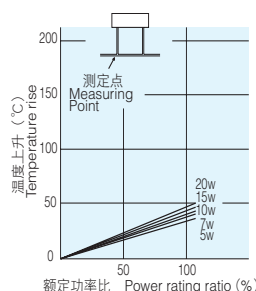

⑧H, Q Style

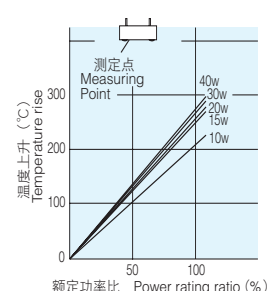

■ 性能 Performance

试验项目 Test Items	标准值 Performance Requirements $\Delta R \pm \%$		试验方法 Test Methods
	保证值 Limit	代表值 Typical	
电阻值 Resistance	在规定的允许偏差内 Within specified tolerance	-	25°C
电阻温度系数 T.C.R.	在规定的允许偏差内 Within specified tolerance	-	+25°C/-55°C and +25°C/+125°C
耐焊接热 Resistance to soldering heat	1: BWR, BSR 2: BGR	0.8: BWR 1.7: BGR 0.9: BSR	350°C ± 10°C, 3.5s
耐湿负荷 Moisture resistance	3: BWR, BGR 5: BSR	2.4: BWR 2.55: BGR 4.5: BSR	Power rating × 1/10, 40°C, 90%~95%RH, 1000h 1.5小时ON、0.5小时OFF的周期 1.5h ON/0.5h OFF cycle
在70°C时的耐久性 Endurance at 70°C	3: BWR 5: BGR, BSR	2.4: BWR 4.25: BGR 4.5: BSR	额定电压, 70°C, 1000小时, 1.5小时打开 / 0.5小时关闭的周期 Rated voltage, 70°C, 1000h, 1.5h ON/0.5h OFF cycle

■ 使用注意事项 Precautions for Use

- 助焊剂等在本产品和安装的印刷电路板上附着离子性杂质时，其耐湿性·耐腐蚀性将受到影响。助焊剂内有时含有氯·酸等离子性物质，为除去这些离子性物质应进行清洗。去除这些离子性物质时，或元件上有汗水、盐分等离子性物质附着时，请充分清洗。进行清洗时，请事先充分确认清洗的可靠性并决定干燥条件，以免清洗后清洗溶剂残留在电阻器内部。请避免在未彻底干燥的状态下通电或使用。
- 使用交流电路时，由于绕线构造，电路会产生电感成分和寄生容量，有可能发生振动等异常情况。在使用时请仔细考虑其他元件常数的离散情况。
- Ionic impurities such as flux etc. attached to these products or mounted onto PCB, negatively affect the moisture resistance, corrosion resistance, etc. The flux may contain ionic substances like chlorine, acid, etc. Wash thoroughly these ionic substances including sweat and salt. Confirm the reliability of washing and decide the dry conditions so that washing solvent is not to be remained inside the product after washing. Do not apply electricity to the product nor use the product itself until the drying is fully completed.
- In case of using them for an AC circuit, abnormal phenomena like oscillation etc. occasionally happen as they have an inductance or a parasitic capacitance because of their wiring structures. Use them by taking the dispersion of constants of other components into the consideration.

X-ON Electronics

Largest Supplier of Electrical and Electronic Components

Click to view similar products for [koa speer manufacturer](#):

Other Similar products are found below :

[RK73H1JTDD8662F](#) [SR732BTK001KIT](#) [CF1/4C471J](#) [RN73H1JTDD2700B25](#) [SR731JTK001KIT](#) [SR732ATK001KIT](#) [WK73S2HTTE20LJ](#)
[TLR2BWDTD18L0F75](#) [RN73H2ATTD3902B25](#) [RN731JTDD3602B25](#) [RN73H2ATTD6802B25](#) [RN732ATTD1601B25](#) [HV73TK001KIT](#)
[SG73TK001KIT](#) [MO2CT631R220J](#) [RK73Z1JTDD](#) [RK73H1HTTC2742F](#) [RN731JTDD3902B25](#) [RN732ATTD2102B25](#) [SL1TTE15L0F](#)
[TLR2BPDTD10L0F75](#) [WK73S3A3TTE1R50F](#) [SR73W3ATTER100F](#) [RN73H2ATTD1201B25](#) [RN732ATTD6202B25](#)
[RN73H1JTDD1102B25](#) [RN731JTDD1800B25](#) [SR733ATK001KIT](#) [RK73H1FTK001KIT](#) [RK73B2BTDD471J](#) [RK73H2ATTD30R0F](#)
[CF1/4C104J](#) [RK73H3ATTE24R9F](#) [CF1/4C112J](#) [SR73W2HTTER680F](#) [SLN5TTED16L9F](#) [RK73H1HTTC75R0F](#) [RN73H2ATTD3120B25](#)
[MOS1CT52R111J](#) [SL1TTER33J](#) [RN732ATTD8202B25](#) [RN73H2ATTD9102B25](#) [RN731ETTP1600B25](#) [RK73H1JRTTD5602F](#)
[MF1/2CC3322F](#) [RK73H1JTDD1502F](#) [RN732BTDD6191B25](#) [SLZ1TTE](#) [RN732ATTDK2002B10](#) [RN73H1JTDD5601B25](#)