

TSL·SL (金属元件型) ·SLN 电流检测用片式电阻器 Current Detecting Chip Resistors

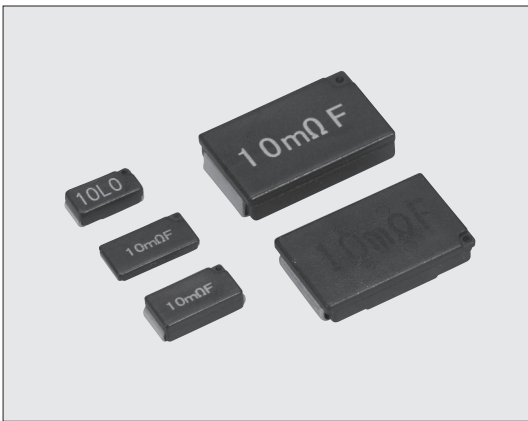

■ 结构图 Construction

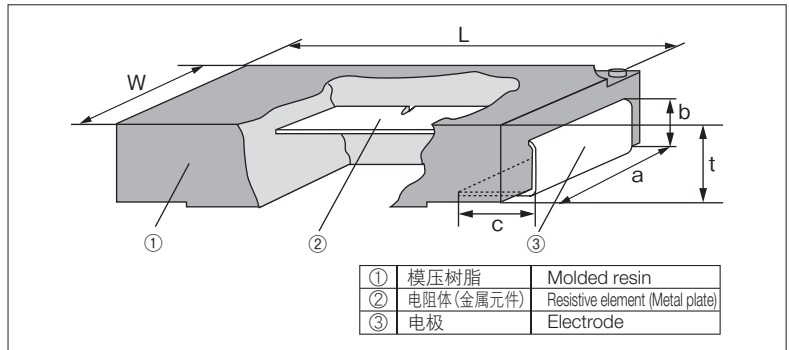

■ 外形尺寸 Dimensions

型号 Type (Inch Size Code)	尺寸 Dimensions (mm)						Weight (g) (1000pcs)
	L±0.3	W±0.2	t±0.2	a±0.2	b±0.2	c	
SL07 (2010)	5.0	2.5	1.7	2.0	0.9	1.2±0.3	45
TSL1 (2512)	6.3	3.1	1.0	2.4	0.7	1.2±0.3	41
SL1·SLZ1 (2512)	6.3	3.1	1.9	2.4	1.2	1.2±0.3	90
SL2 (4527)	11.5	7.0	2.5	5.0	1.7	2.6±0.5	476
SLN2 (4527)	11.5	7.0	2.4	5.5	1.6	2.55±0.4	500

■ 品名构成 Type Designation

实例 Example

SL	1	T	TE	10L0	F	75
品种 Product Code	额定功率 Power Rating	端子表面材质 Terminal Surface Material	二次加工 Taping	公称电阻值* Nominal Resistance	阻值允许偏差 Resistance Tolerance	电阻温度系数 T.C.R. (×10 ⁻⁶ /K)
TSL SL SLN	0.7:0.75W 1:1W 2:2W	T:Sn	TE:Plastic embossed BK:Bulk	D,F:4 digits J,G:3 digits Ex. 0.1Ω:R10 5mΩ:5L0	D:±0.5% F:±1% G:±2% J:±5%	Nil:0~150 0~200 ±75(SLN2) ±100 ±180 ±180 50:±50(SL1) 75:±75(SL1)

※1	电阻值范围(Ω) Resistance Value	3位显示 3 digits	电阻值范围(Ω) Resistance Value	4位显示 4 digits
	3m~9.1m	3L0~9L1	5m~9.1m	5L00~9L10
	10m~91m	10L~91L	10m~91m	10L0~91L0
	0.1~0.36	R10~R36	0.1~0.36	R100~R360

端子表面材质, 以无铅品为准。
欲知关于此产品含有的环境有害物质详情(除EU-RoHS以外), 请与我们联系。
编带细节请参考卷末附录C。
The terminal surface material lead free is standard.
Contact us when you have control request for environmental hazardous material other than the substance specified by EU-RoHS.
For further information on taping, please refer to APPENDIX C on the back pages.

■ 跳线额定 Jumper Ratings

型号 Type	电阻值 Resistance	额定电流 Current Rating	电阻温度系数 T.C.R. (×10 ⁻⁶ /K)
SLZ1	0.5mΩ以下 0.5mΩ max.	44A	4000以下 4000 max.

外观颜色: 黑色 Coating color: Black

■ 特点 Features

- 是小型、超低电阻值(3mΩ~)、高精度(±0.5%)、SMD形状的电流检测用电阻器。
- 是阻燃性树脂(UL94 V-0)模压密封型。
- 由于是模压成形, 尺寸精度高, 装载性、耐冲击性好。
- 由于是金属端子电极, 端子强度、焊接性优异。
- 是金属板端子电极结构, 吸收热膨胀收缩。
- 对应波峰焊、回流焊、烙铁焊接。
- 端子无铅品, 符合欧盟RoHS。
- AEC-Q200相关数据已取得。
- SMD type of small size, ultra-low resistance (3mΩ~) and high accuracy (±0.5%) resistor for current detection.
- Encapsulated with flame retardant resin molding. (UL94 V-0)
- Excellent dimension accuracy, mountability and shock-resistance due to molded products.
- Excellent terminal strength and solderability due to structure of a metal plate terminal electrode.
- Easy to absorb the thermal expansion and shrinkage because of a metal plate terminal structure.
- Suitable for flow, reflow and iron solderings.
- Products with lead free termination meet EU-RoHS requirements.
- AEC-Q200 qualified.

■ 用途 Applications

汽车	Automotive
笔记本电脑	Note PCs
电池组	Battery packs
AC适配器	AC Adapters
DC-DC换流器	DC-DC converters, etc.

■ 参考标准 Reference Standards

IEC 60115-1
JIS C 5201-1

■ 额定值 Ratings

型号 Type	额定功率 Power Rating	额定环境温度 Rated Ambient Temp.	额定端子部温度 Rated Terminal Part Temp.	电阻值范围*3 Resistance Range (Ω)				电阻温度系数 T.C.R. (×10 ⁻⁶ /K)	使用温度范围 Operating Temp. Range	编带和包装数/卷 Taping & Qty / Reel (pcs)
				D: ±0.5% E24·E96*4	F: ±1% E24·E96*4	G: ±2% E24	J: ±5% E24			
SL07	0.75W	70℃	125℃	—	5m~100m	—	5m~100m	0~200:R<11mΩ 0~150:R≥11mΩ	-55℃~+180℃	2,000
TSL1	1W			10m~100m	5m~100m	—	5m~100m	±180:R<15mΩ ±100:R≥15mΩ		3,000
SL1	1W			10m~102m	5m~102m	3m、4m	5m~100m	±180:R<15mΩ ±100:R≥15mΩ		1,000
SL1 (TCR±50ppm)	1W			34.8m~200mΩ	34.8m~200mΩ	—	36m~200mΩ	±50ppm		
SL1 (TCR±75ppm)	1W			20m~200mΩ	20m~200mΩ	—	20m~200mΩ	±75ppm		
SL2	2W			10m~360mΩ	5m~360mΩ	3m、4m	3m~360mΩ	±180:R<11mΩ ±100:R≥11mΩ		
SLN2	2W	—	120℃	5m~200m	5m~200m	—	5m~200m	±110:R<10mΩ ±75:R≤10mΩ	—	

额定电压是√(额定功率×公称电阻值)所算出的值或表中最高使用电压两者中小值为额定电压。

Rated voltage = √(Power Rating × Resistance value or Max. working voltage, whichever is lower).

*3 在电阻值范围内, 3m、4m、5m、6m、7m、8m、9mΩ都对应。3m、4m、5m、6m、7m、8m和9mΩ are available in each resistance range.

*4 SL07及SL1 (T.C.R.: ±50/±75 ppm中102mΩ≤R≤200mΩ) 的E96系列不适用(仅E24系列) SL07 and SL1 (T.C.R.: ±50/±75 ppm, 102mΩ≤R≤200mΩ) offer only E24 series.

根据客户的使用状况, 如果不清楚是该使用额定环境温度还是额定端子部温度, 请以额定端子部温度为优先。

详情请参照14~17页的“端子部温度负荷特性曲线的说明”。

If any questions arise whether to use the “Rated Ambient Temperature” or the “Rated Terminal Part Temperature” in your usage conditions, please give priority to the “Rated Terminal Part Temperature”.

For more details, please refer to “Introduction of the derating curves based on the terminal part temperature” in page 14 to 17.

■ 负荷减轻特性曲线 Derating Curve

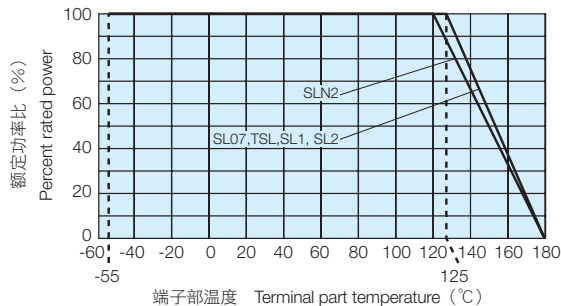
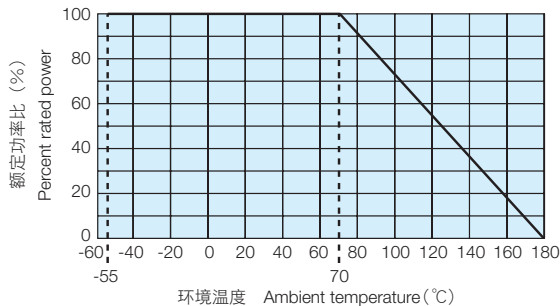

在环境温度70℃以上使用时，应照上图负荷减轻特性曲线，减小额定功率。
For resistors operated at an ambient temperature of 70°C or above, a power rating shall be derated in accordance with the above derating curve.

超过上述端子部温度使用时，请根据负荷减轻特性曲线减小额定功率后使用。
※关于使用方法，请参照卷首的“端子部温度负荷减轻特性曲线的说明”。
For resistors operated terminal part temperature of described for each size or above a power rating shall be derated in accordance with derating curve.
※Please refer to "Introduction of the derating curve based on the terminal part temperature" on the beginning of our catalog before use.

■ 温度上升 Temperature Rise

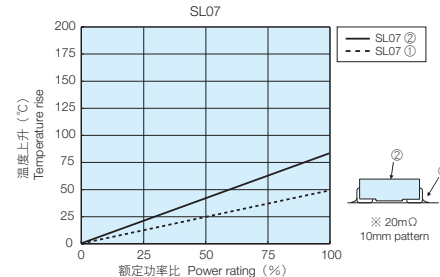
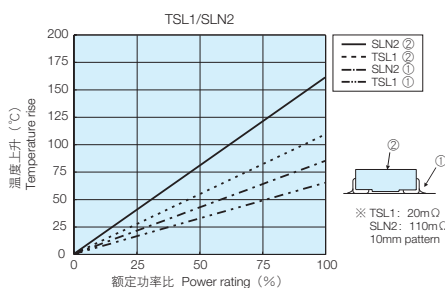
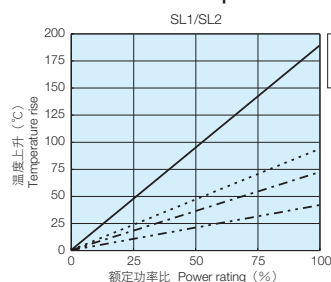

表面温度上升，是以本公司测定条件测定的，由于使用状况、使用基板不同，数值也会有所不同，因此，在使用时请另行询问。

Regarding the temperature rise, the value of the temperature varies per conditions and board for use since the temperature is measured under our measuring conditions. Please refer to us before use.

■ 性能 Performance

试验项目 Test Items	标准值 Performance Requirements ΔR±%		试验方法 Test Methods
	保证值 Limit	代表值 Typical	
电阻值 Resistance	在规定的允许偏差内 Within specified tolerance	-	25°C
电阻温度系数 T.C.R.	在规定值以内 Within specified T.C.R.	-	25°C/+125°C
过载(短时间) Overload (Short time)	1: SL07, TSL1, SL1, SL2 0.5: SLN2	1: SL07, TSL1, SL1, SL2 0.25: SLN2	SL07: 额定功率×4倍施加5秒钟 Rated power×4 for 5s TSL1: 额定功率×2.5倍施加5秒钟 Rated power×2.5 for 5s SL1, SL2: 额定功率×5倍施加5秒钟 Rated power×5 for 5s (SL1 (T.C.R.: ±50/±75): 额定功率×4倍施加5秒钟) (SL1 (T.C.R.: ±50/±75): Rated power×4 for 5s)
耐焊接热 Resistance to soldering heat	1: SL07, TSL1, SL1, SL2 0.5: SLN2	1: SL07, TSL1, SL1, SL2 0.5: SLN2	260°C±5°C, 10s±1s 260°C±5°C, 10s~12s
温度突变 Rapid change of temperature	1: SL07, TSL1, SL1, SL2 0.5: SLN2	0.5: SL07, TSL1, SL1, SL2 0.25: SLN2	-55°C (30min.) / +150°C (30min.) 100 cycles -55°C (15min.) / +150°C (15min.) 1000 cycles
耐湿负荷 Moisture resistance	2: SL07, TSL1, SL1, SL2	0.5: SL07, TSL1, SL1, SL2	40°C±2°C, 90%~95%RH, 1000h 1.5小时ON、0.5小时OFF的周期 1.5h ON/0.5h OFF cycle
	0.5: SLN2	0.25: SLN2	85°C±2°C, 85%RH±3%RH, 1000h 额定功率×0.1倍 Rated power×0.1
在70℃时的耐久性 Endurance at 70°C	2: SL07, TSL1, SL1, SL2 1: SLN2	1	70°C±2°C, 1000h 1.5小时ON、0.5小时OFF的周期 1.5h ON/0.5h OFF cycle
低温放置 Low temperature exposure	0.5	0.25	SL07, TSL1, SL1, SL2: -55°C, 1h SLN2: -65°C, 24h

■ 使用注意事项 Precautions for Use

- 作为分流电阻使用时，应考虑和周围线圈的电磁感应后配置模式。
- 在50 mΩ以下的电阻值，根据焊盘图案大小和接续焊接的量，焊接后的电阻值会变动。应在事前确认电阻值降低/提高的影响后，进行设备设计。
- In case of using the low ohm resistors as shunt resistors, please lay out a pattern considering the electromagnetic induction with surrounding inductors.
- In the resistance values of 50mΩ or under, the resistance value after soldering may change depending on the size of pad pattern or solder amount. Make sure the effect of decline/increase of resistance value before designing.

X-ON Electronics

Largest Supplier of Electrical and Electronic Components

Click to view similar products for [Current Sense Resistors - SMD category](#):

Click to view products by [KOA Speer manufacturer](#):

Other Similar products are found below :

[CRL0603-FW-R700ELF](#) [PFS35-200RF1](#) [NPS 2-T126 5.000 OHM 1%](#) [PFS35-0R01J1](#) [PFS35-0R05J1](#) [PFS35-5RF1](#) [CD2015FC-0.10-1%](#)
[PR2512FKF7W0R004L](#) [RC1005F124CS](#) [RL73K3AR56JTDF](#) [RL7520WT-R001-F](#) [RL7520WT-R009-G](#) [RL7520WT-R020-F](#)
[RLP73N1ER43JTD](#) [LRC-LR2512LF-01-R820J](#) [WR06X104JGLJ](#) [TL2BR01F](#) [65709-330](#) [SP1R12J](#) [RL7520WT-R039-G](#) [RL7520WT-R002-F](#)
[LRF2010-R003JW](#) [KRL1632E-C-R200-F-T5](#) [KRL1632E-C-R200-F-T1](#) [Y14880R02000B9R](#) [RLP73M1ER051FTDF](#) [RLP73M2AR051FTDF](#)
[RLP73M2AR075FTDF](#) [RLP73M1JR051FTDF](#) [RLP73N1JR47FTDF](#) [SR731ERTTP5R10F](#) [SR731ERTTP100J](#) [SR731ERTTP6R80F](#)
[SR731ERTTP4R70F](#) [SR731ERTTP2R20F](#) [SR731ERTTP3R90F](#) [SR731ERTTP1R00F](#) [SR731ERTTP10R0F](#) [SR731ERTTP2R00F](#)
[SR731ERTTP8R20F](#) [SR731ERTTP3R9J](#) [SR731ERTTP8R2J](#) [SR731ERTTP2R0J](#) [SR731ERTTP4R7J](#) [SR731ERTTP9R1J](#) [SR731ERTTP1R0J](#)
[SR731ERTTP2R2J](#) [SR731ERTTP5R1J](#) [SR731ERTTP6R8J](#) [SR731ERTTP9R10F](#)