

MDA Series
SMD Low Profile High Current Molded Inductor
Size 5030



FEATURES

- Shielded construction
- Capable of corresponding high frequency .
- Low loss realized with low DCR.
- High performance (Isat) realized by metal dust core.
- Ultra low buzz noise, due to composite construction.
- 100% Lead(Pb)-Free and RoHS compliant.
- High reliability -Reliability test complied to AEC-Q200
- Operating temperature: -55 to +155 °C (including self-temperature rise)
- Quantity: 2000PCS

APPLICATION

- Headlamps, tail lamps and interior lighting
- HVAC
- Doors, window lift and seat control
- Audio subsystem
- Digital instrument cluster
- In-Vehicle Infotainment and navigation

Dimensions: [mm]

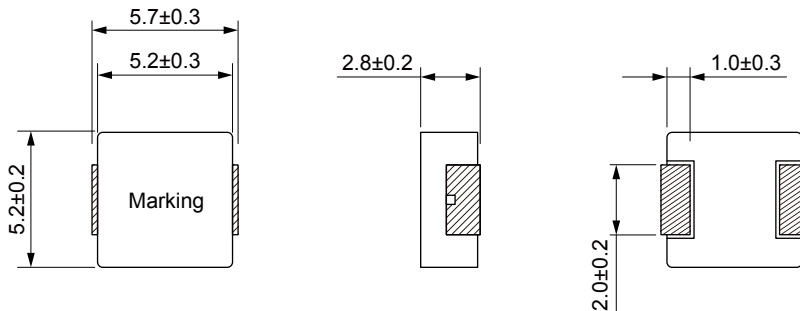

Land Pattern: [mm]

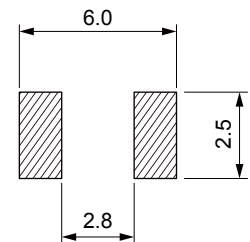

Electrical Properties:

Part No	Inductance @ 100KHz/1V (μH)	Tolerance	Temperature Rise Current Typ. (A)	Saturation Current Typ. (A)	DC Resistance Typ. (mΩ)	DC Resistance Max. (mΩ)
MDA5030-R47M	0.47	±20%	13.5	10.0	5.20	6.00
MDA5030-R68M	0.68	±20%	12.5	9.0	7.40	8.50
MDA5030-R82M	0.82	±20%	10.0	8.8	8.00	9.20
MDA5030-1R0M	1.00	±20%	9.0	8.5	10.5	12.0
MDA5030-1R5M	1.50	±20%	8.0	7.5	13.6	15.7
MDA5030-2R2M	2.20	±20%	7.0	6.5	21.6	25.0
MDA5030-3R3M	3.30	±20%	6.3	6.0	28.0	33.0
MDA5030-4R7M	4.70	±20%	5.5	5.3	38.0	44.0
MDA5030-5R6M	5.60	±20%	5.0	4.6	50.0	58.0
MDA5030-6R8M	6.80	±20%	4.3	3.5	57.0	66.0
MDA5030-100M	10.0	±20%	3.8	2.5	88.0	103

Saturation Current will cause L to drop approximately 30%

Temperature Rise Current: The actual value of DC current when the temperature rise is ΔT=40°C

Typical Electrical Characteristics:

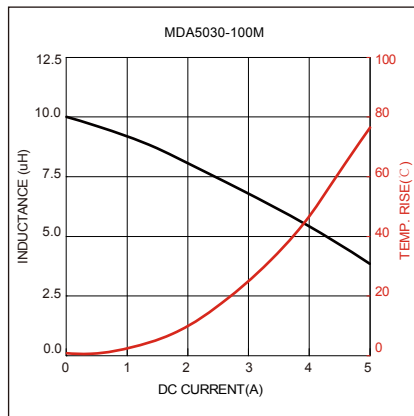
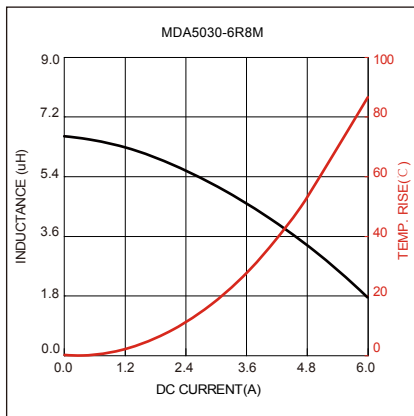
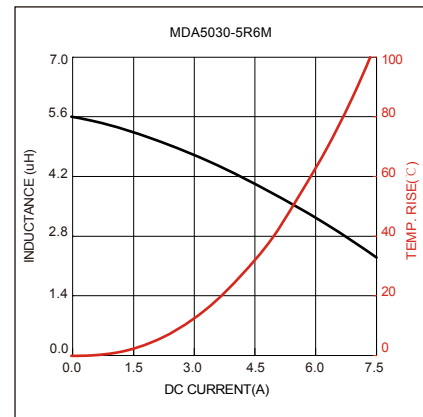
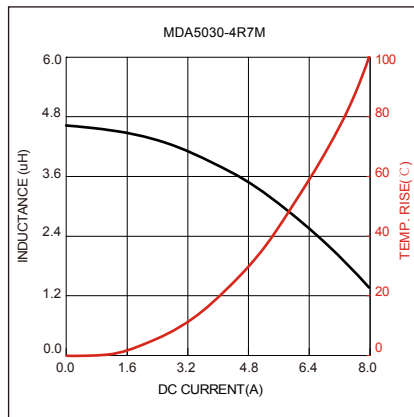
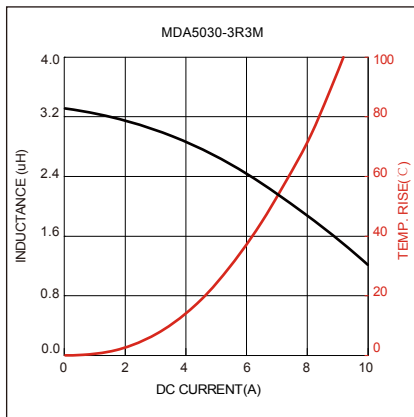
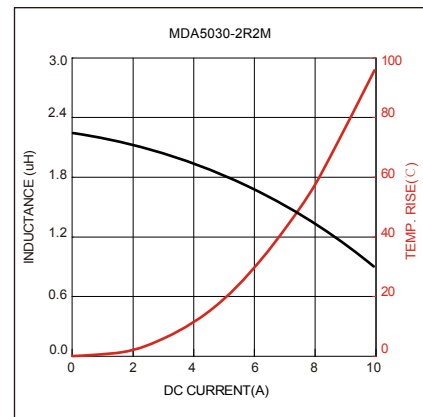
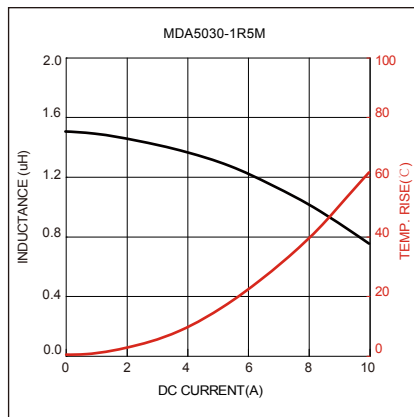
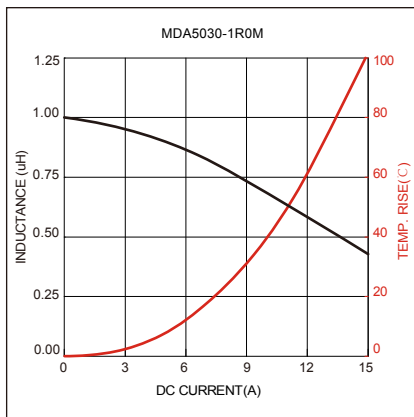
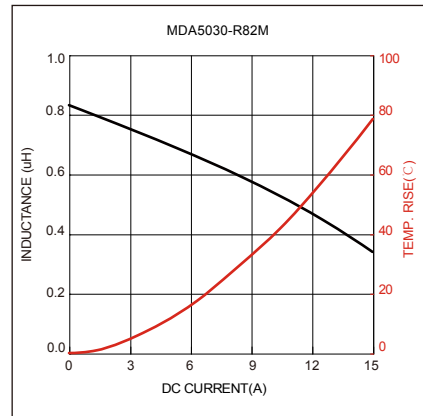
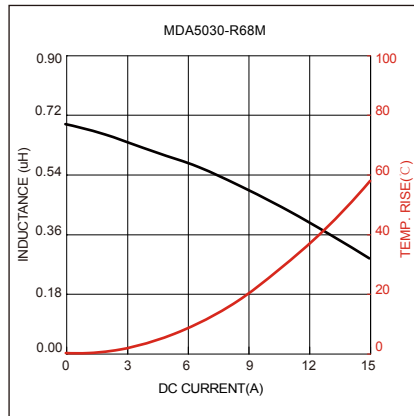
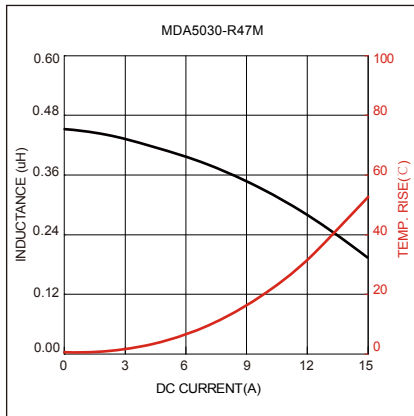

X-ON Electronics

Largest Supplier of Electrical and Electronic Components

Click to view similar products for [Fixed Inductors](#) category:

Click to view products by [KOHER](#) manufacturer:

Other Similar products are found below :

[CR32NP-100KC](#) [CR54NP-470LC](#) [70F224AI](#) [MGDQ4-00004-P](#) [MHQ1005P10NJ](#) [MHQ1005P1N0S](#) [MHQ1005P2N4S](#) [MHQ1005P3N6S](#)
[MHQ1005P5N1S](#) [MHQ1005P8N2J](#) [PE-53601NL](#) [PE-53602NL](#) [PG0936.113NLT](#) [9220-20](#) [9310-16](#) [PM06-2N7](#) [PM06-39NJ](#) [A01TK](#)
[1206CS-471XJ](#) [HC2-R47-R](#) [HC8-1R2-R](#) [HCF1305-3R3-R](#) [1206CS-151XG](#) [RCH664NP-140L](#) [RCH664NP-4R7M](#) [RCP1317NP-391L](#)
[RCR110DNP-331L](#) [DH2280-4R7M](#) [DS1608C-106](#) [B10TJ](#) [B82498B3101J000](#) [ELJ-RE27NJF2](#) [1812CS-153XJ](#) [1812CS-183XJ](#) [1812CS-](#)
[223XJ](#) [1812LS-104XJ](#) [1812LS-105XJ](#) [1812LS-124XJ](#) [1812LS-154XJ](#) [1812LS-223XJ](#) [1812LS-224XJ](#) [1812LS-563XJ](#) [1812LS-683XJ](#)
[1812LS-824XJ](#) [NIN-FB101JTR110F](#) [NIN-FB471JTR62F](#) [NIN-FC1R5JTR220F](#) [NIN-HCR15JTRF](#) [NIN-HCR33JTRF](#) [NIN-HDR22JTRF](#)