

**SCM Series**  
Common Mode Filter  
Size 1210

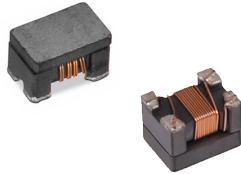

**FEATURES**

- High self-resonance frequency enables high cut-off frequency, wide band noise suppress in high frequency.
- Small size and low profile.
- Operating temperature -40~+125 °C (Including self - temperature rise)

**FEATURES**

- USB 3.0 lines
- AV interfaces, such as HDMI 1.3/1/4
- High-speed signal lines

Dimensions: [mm]

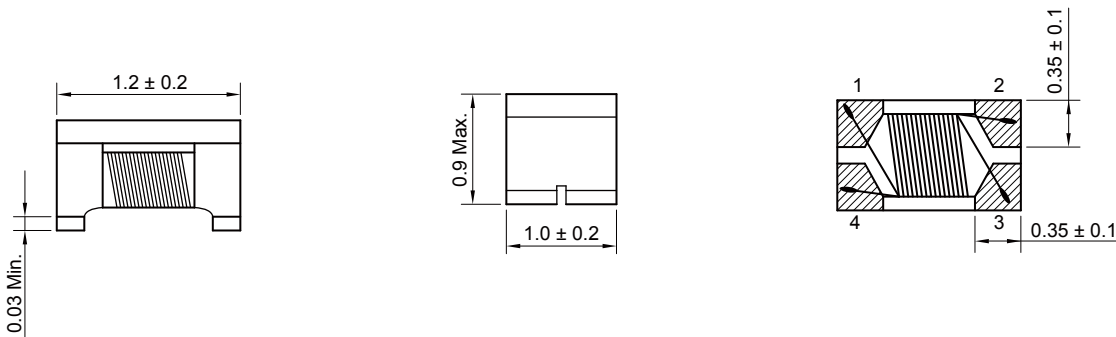

Schematic:



Electrical Properties:

Part No	Impedance @ 100 MHz (Ω)	Tolerance	DC Resistance Max. (Ω)	Rated Current Max. (mA)	Rated Volt (V)	Withstand Volt (V)	IR Min. (MΩ)
SCM1210HS-350-02	35	±25%	0.30	200	50	125	10
SCM1210HS-500-02	50	±25%	0.30	250	50	125	10
SCM1210HS-600-02	60	±25%	0.30	250	50	125	10
SCM1210HS-900-02	90	±25%	0.40	200	50	125	10

## Typical Electrical Characteristics:

### Impedance VS Frequency

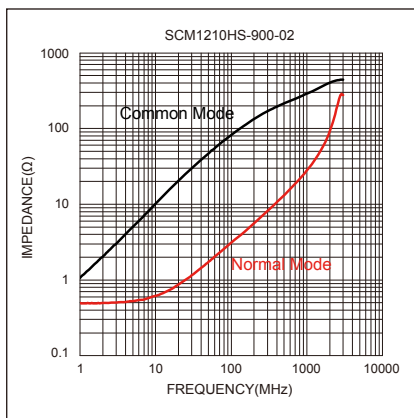
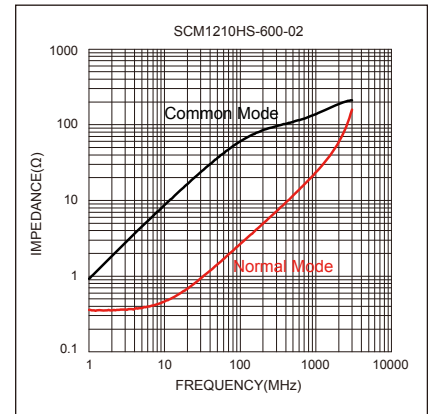
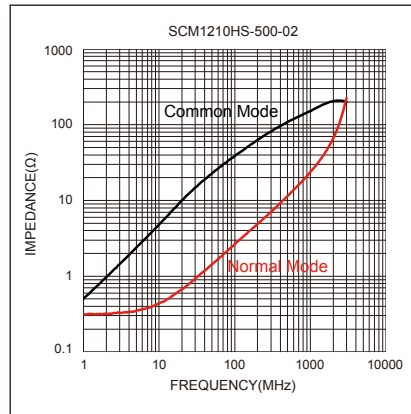
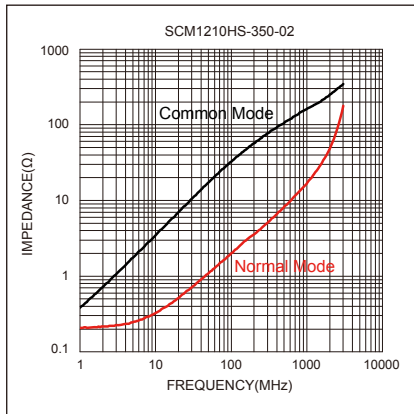

### Attenuation VS Frequency

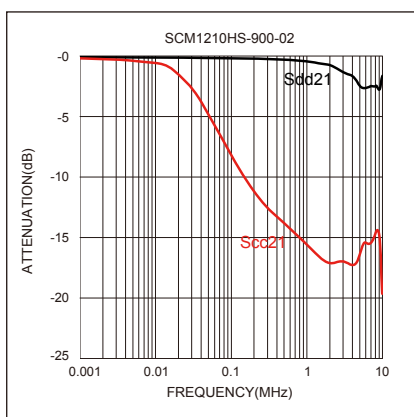
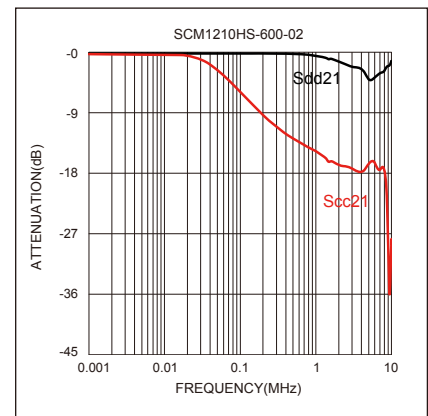
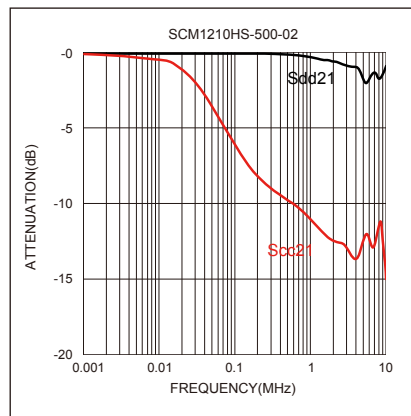
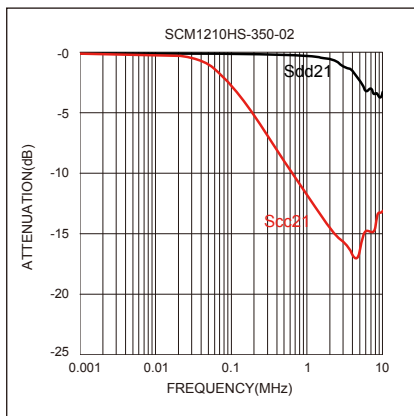

## X-ON Electronics

Largest Supplier of Electrical and Electronic Components

*Click to view similar products for [Common Mode Chokes / Filters](#) category:*

*Click to view products by [KOHER](#) manufacturer:*

Other Similar products are found below :

[74279408](#) [PE-62911NL](#) [PE-64683](#) [RD5122-6-9M6](#) [RGCMF1210900H3T](#) [ST6118T-R](#) [FE3X025-10-7NL](#) [T8114NLT](#) [RD5122-10-6M0](#)  
[TCM0806G-350-2P-T](#) [TCM0806G-650-2P-T](#) [IND-0110](#) [UAL21VR0802000](#) [UALSC023000000](#) [UALSC1020JH000](#) [UALSC1520JH000](#)  
[UALSU10VR15019](#) [UALSU9VD070100](#) [36-00037](#) [5701610000](#) [UALW21HS200290](#) [UALW21HS072450](#) [UALSU9HF050500](#)  
[UALSU9H0208000](#) [UAL24VK06450CH](#) [PLT10HH501100PNB](#) [PLT10HH401100PNB](#) [PLT10HH1026R0PNB](#) [PE-67531](#) [TLH10UB 113](#)  
[OR5](#) [2752045447](#) [CMS3-11-R](#) [7351V](#) [7408-RC](#) [CMF16-153131](#) [744252510](#) [T8116NLT](#) [CMS2-10-R](#) [DLW44SN101SK2L](#) [FE2X10-4-2NL](#)  
[744253200](#) [744253101](#) [744252220](#) [TX8111NLT](#) [UAL30VR3500470](#) [CTX01-19077-R](#) [T8003NLT](#) [CTX01-13663](#) [CTX66-19521-R](#)  
[7446630047](#)