

**SCM Series**  
Common Mode Filter  
Size 2012

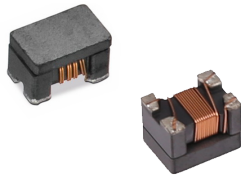

**FEATURES**

- High common mode impedance for outstanding noise suppression performance.
- Realize small size and low profile. 0\*0\*2mm
- Operating temperature -40~+125 C
- Excellent solderability

**FEATURES**

- USB2.0 lines for PC, TV, Peripheral equipments
- Standard signal lines
- Audio lines

Dimensions: [mm]

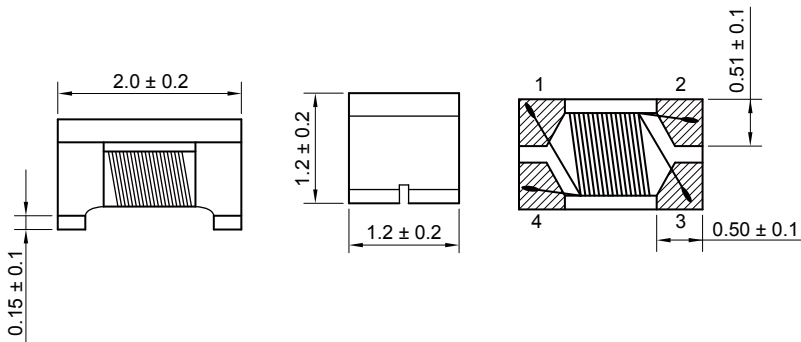

Schematic:

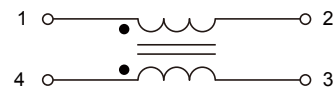

Electrical Properties:

Part No	Impedance @ 100 MHz (Ω)	Tolerance	DC Resistance Max. (Ω)	Rated Current Max. (mA)	Rated Volt Max. (Volts)	Withstand Volt Max. (Volts)	IR Min. (MΩ)
SCM2012-670-04	67	±25%	0.25	400	50	125	10
SCM2012-900-04	90	±25%	0.30	400	50	125	10
SCM2012-121-04	120	±25%	0.30	400	50	125	10
SCM2012-161-04	160	±25%	0.35	350	50	125	10
SCM2012-181-04	180	±25%	0.35	350	50	125	10
SCM2012-201-03	200	±25%	0.40	300	50	125	10
SCM2012-221-03	220	±25%	0.40	300	50	125	10
SCM2012-261-03	260	±25%	0.40	300	50	125	10
SCM2012-361-03	360	±25%	0.50	300	50	125	10
SCM2012-601-03	600	±25%	0.88	300	50	125	10
SCM2012-801-03	800	±25%	0.88	300	50	125	10
SCM2012-102-01	1000	±25%	1.30	100	50	125	10

Typical Electrical Characteristics:

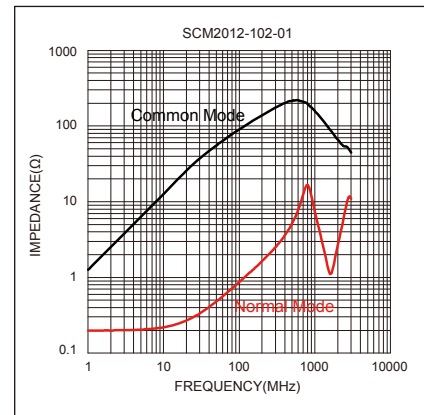
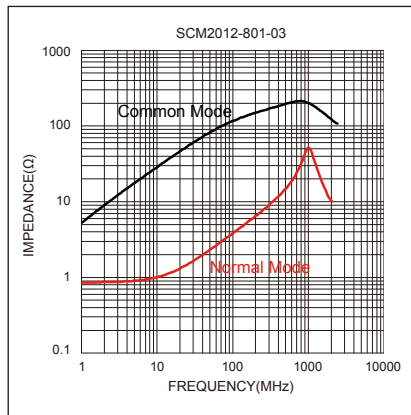
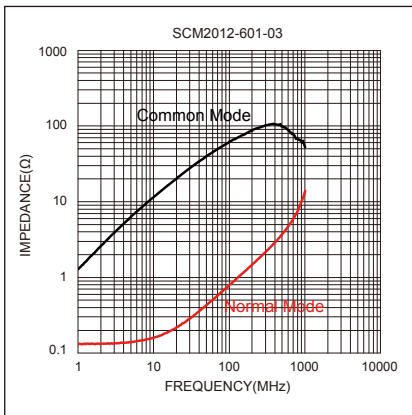
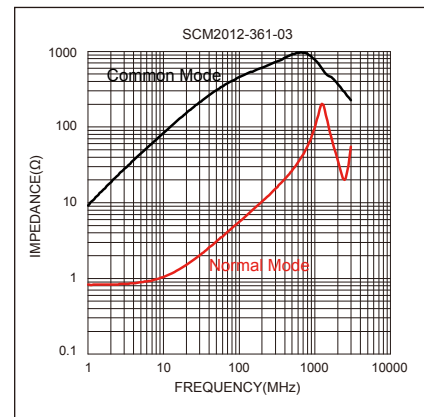
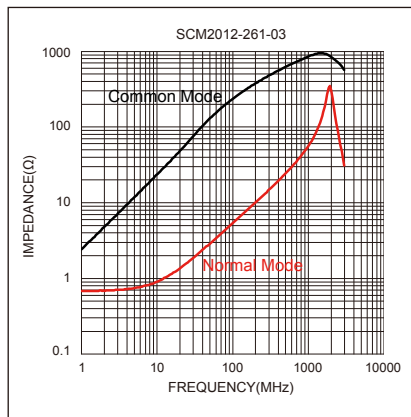
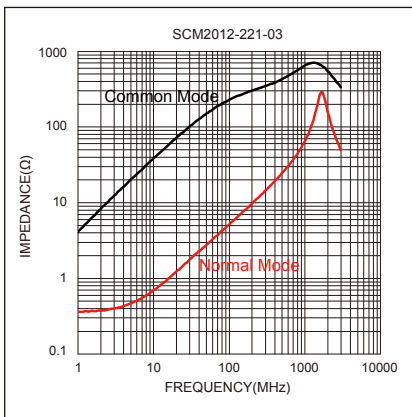
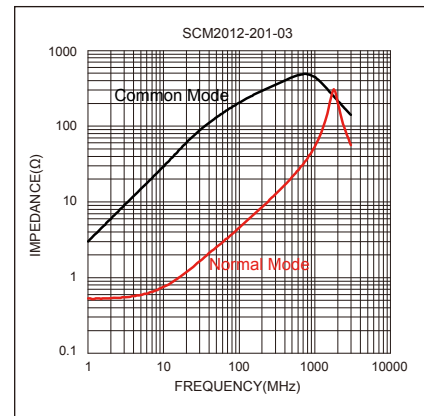
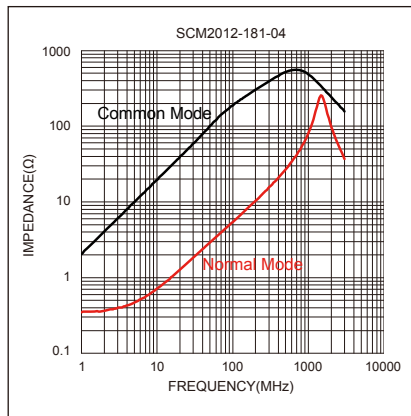
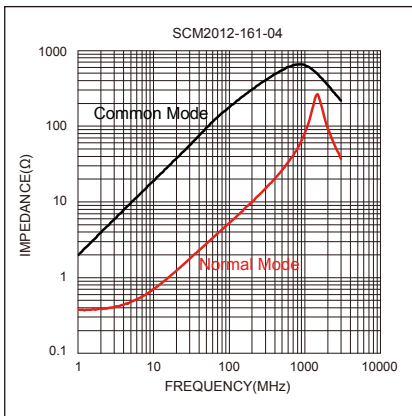
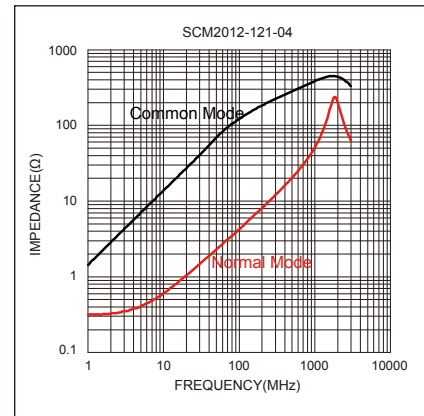
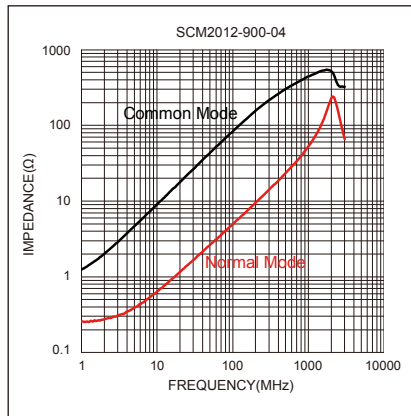
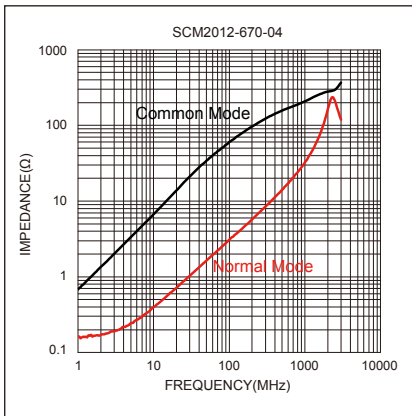

## X-ON Electronics

Largest Supplier of Electrical and Electronic Components

*Click to view similar products for [Common Mode Chokes / Filters](#) category:*

*Click to view products by [KOHER](#) manufacturer:*

Other Similar products are found below :

[74279408](#) [PE-62911NL](#) [PE-64683](#) [RD5122-6-9M6](#) [RGCMF1210900H3T](#) [ST6118T-R](#) [FE3X025-10-7NL](#) [T8114NLT](#) [RD5122-10-6M0](#)  
[TCM0806G-350-2P-T](#) [TCM0806G-650-2P-T](#) [IND-0110](#) [UAL21VR0802000](#) [UALSC023000000](#) [UALSC1020JH000](#) [UALSC1520JH000](#)  
[UALSU10VR15019](#) [UALSU9VD070100](#) [36-00037](#) [5701610000](#) [UALW21HS200290](#) [UALW21HS072450](#) [UALSU9HF050500](#)  
[UALSU9H0208000](#) [UAL24VK06450CH](#) [PLT10HH501100PNB](#) [PLT10HH401100PNB](#) [PLT10HH1026R0PNB](#) [PE-67531](#) [TLH10UB 113](#)  
[OR5](#) [2752045447](#) [CMS3-11-R](#) [7351V](#) [7408-RC](#) [CMF16-153131](#) [744252510](#) [T8116NLT](#) [CMS2-10-R](#) [DLW44SN101SK2L](#) [FE2X10-4-2NL](#)  
[744253200](#) [744253101](#) [744252220](#) [TX8111NLT](#) [UAL30VR3500470](#) [CTX01-19077-R](#) [T8003NLT](#) [CTX01-13663](#) [CTX66-19521-R](#)  
[7446630047](#)