

SCM Series
Common Mode Filter
Size 3216



FEATURES

- High common mode impedance for outstanding noise suppression performance.
- Small influence on high speed signals through good coupling.
- Operating temperature -40~+125 C (Including self - temperature rise)
- Excellent solderability

FEATURES

- USB2.0 lines for PC, TV, Peripheral equipments
- Standard signal lines
- Audio lines

Dimensions: [mm]

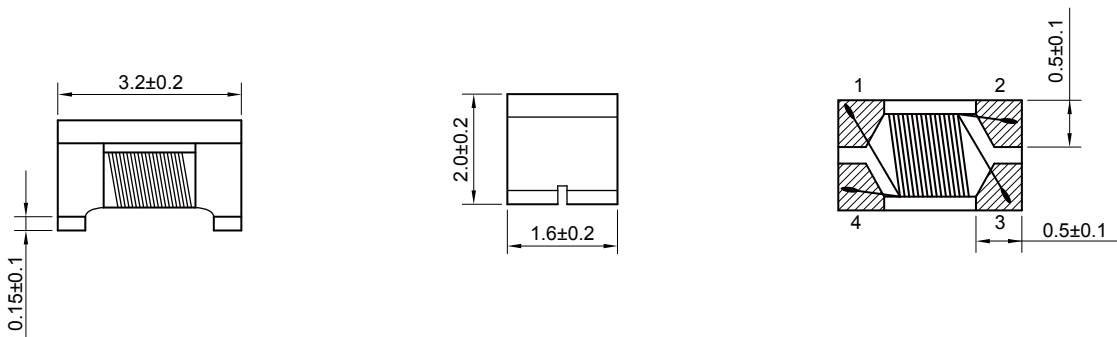

Schematic:



Electrical Properties:

Part No	Impedance @ 100 MHz (Ω)	Tolerance	DC Resistance Max. (Ω)	Rated Current Max. (mA)	Rated Volt Max. (V)	Withstand Volt Max. (V)	IR Min. (MΩ)
SCM3216-900-04	90	±25%	0.30	400	50	125	10
SCM3216-121-03	120	±25%	0.30	350	50	125	10
SCM3216-161-03	160	±25%	0.40	350	50	125	10
SCM3216-221-03	220	±25%	0.45	300	50	125	10
SCM3216-261-03	260	±25%	0.50	300	50	125	10
SCM3216-361-03	360	±25%	0.60	300	50	125	10
SCM3216-601-03	600	±25%	0.80	300	50	125	10
SCM3216-102-02	1000	±25%	1.00	200	50	125	10
SCM3216-222-02	2200	±25%	1.20	200	50	125	10

Typical Electrical Characteristics:

Impedance VS Frequency

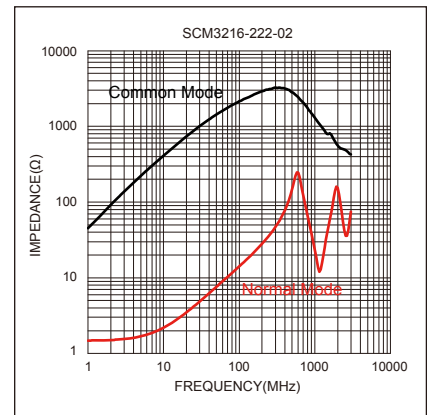
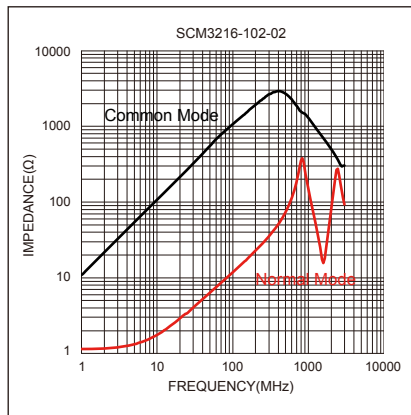
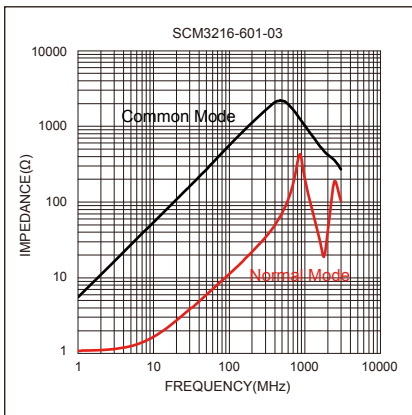
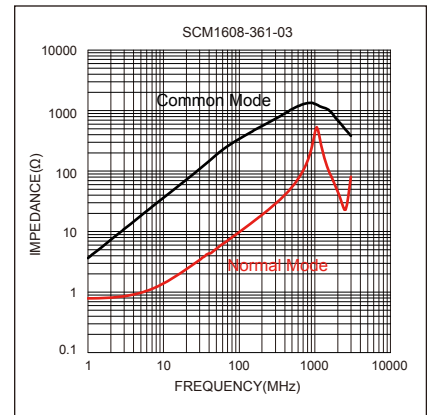
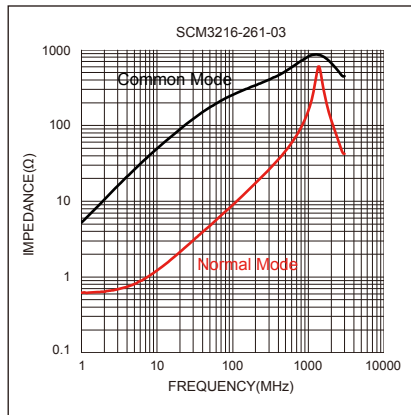
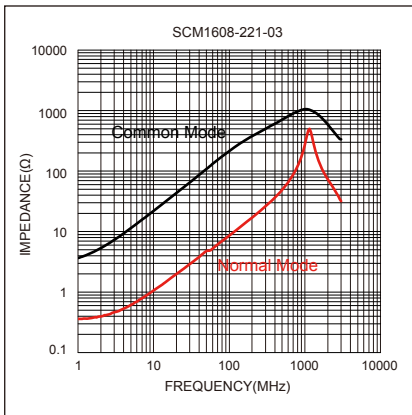
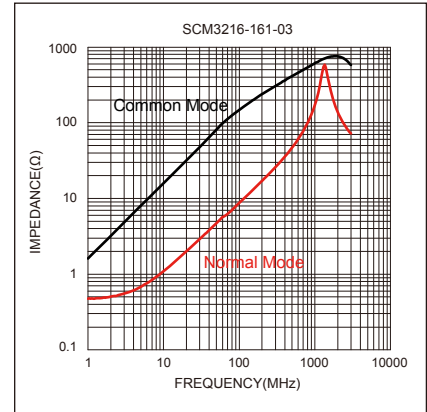
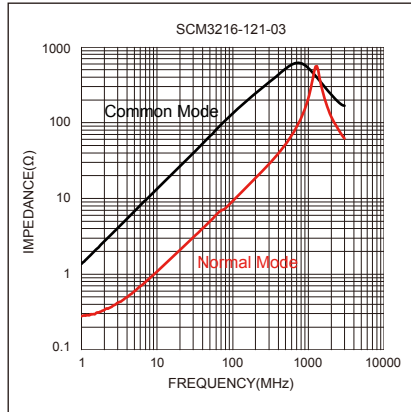
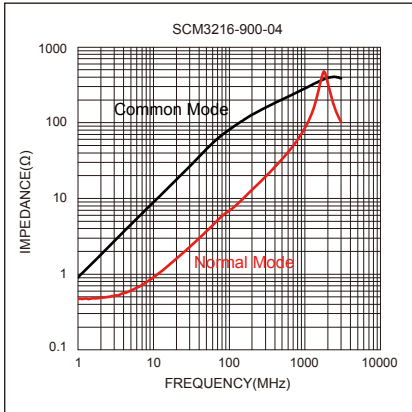

X-ON Electronics

Largest Supplier of Electrical and Electronic Components

Click to view similar products for [Common Mode Chokes / Filters](#) category:

Click to view products by [KOHER](#) manufacturer:

Other Similar products are found below :

[PE-64683](#) [RD5122-6-9M6](#) [ST6118T-R](#) [FE3X025-10-7NL](#) [T8114NLT](#) [TCM0806G-350-2P-T](#) [TCM0806G-650-2P-T](#) [IND-0110](#)
[UAL21VR0802000](#) [UALSC023000000](#) [UALSC1020JH000](#) [UALSU10VD20010](#) [UALSU9VD070100](#) [36-00037](#) [CM7060M132R-10](#)
[UALW21HS072450](#) [UALSU9H0208000](#) [UAL24VK06450CH](#) [PLT10HH501100PNB](#) [PLT10HH401100PNB](#) [PLT10HH1026R0PNB](#) [36-](#)
[00029-01](#) [PE-67531](#) [TLH10UB](#) [113 OR5](#) [2752045447](#) [CM8663Z161B-10](#) [7351V](#) [CMF16-153131](#) [T8116NLT](#) [CMS2-10-R](#) [FE2X10-4-2NL](#)
[T8003NLT](#) [CTX01-13663](#) [CTX66-19521-R](#) [RC212-0.5-10M](#) [RC112-0.4-15M](#) [RC212-0.6-6M8](#) [RC212-0.4-15M](#) [RC112-0.3-30M](#) [4534-3](#)
[WTCF2012Z0M751PB](#) [PH9408.814NLT](#) [B82498B3221J000](#) [PAC6006.364NLT](#) [PAC6006.444NLT](#) [PAC6006.204NLT](#) [PH9407.204NLT](#)
[PAC6006.264NLT](#) [PH9408.105NLT](#) [PH9408.494NLT](#)