

SCM Series
SMD Common Mode Inductor
Size 5020



FEATURES

- Chip common mode filter for large current applications.
- Optimal for surface mounting with low profile 2.5 mm.
- Operating temperature -40~+125 °C

APPLICATIONS

- Countermeasure of Common mode noise in power lines for various devices

Dimensions: [mm]

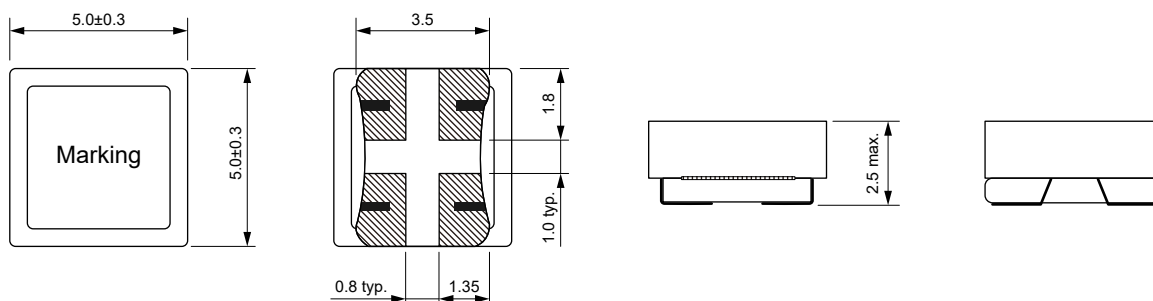

Schematic:



Land Pattern: [mm]

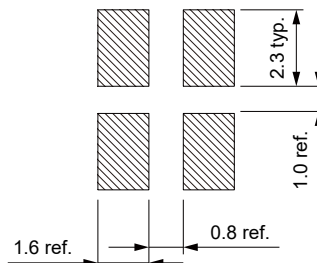

Electrical Properties:

Part No	Impedance @ 100 MHz Min. (Ω)	Impedance @ 100 MHz Typ. (Ω)	Tolerance	DC Resistance Max. (Ω)	Temperature Rise Current Max. (A)	Rated Volt (V)	Withstand Volt (V)	IR Min. (MΩ)
SCM5020-101Y	60	100	±35%	0.015	6.0	50	125	10
SCM5020-251Y	120	250	±35%	0.020	5.0	50	125	10
SCM5020-501Y	200	500	±35%	0.030	4.0	50	125	10
SCM5020-102Y	400	1000	±35%	0.045	2.0	50	125	10
SCM5020-142Y	450	1400	±35%	0.055	1.5	50	125	10

Temperature Rise Current will cause the coil temperature rise approximately Δt40 C

Typical Electrical Characteristics:

Impedance VS Frequency

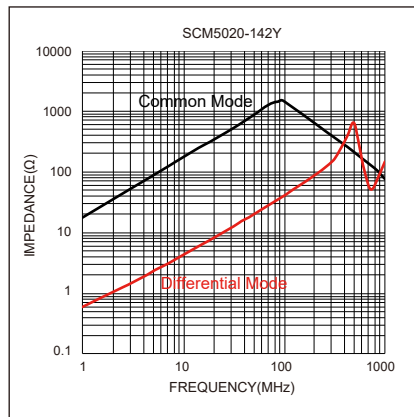
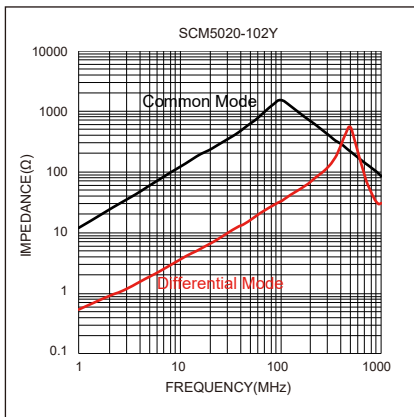
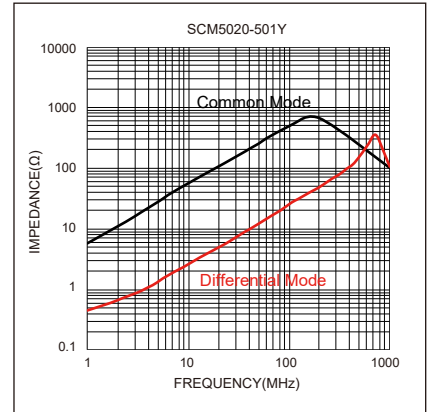
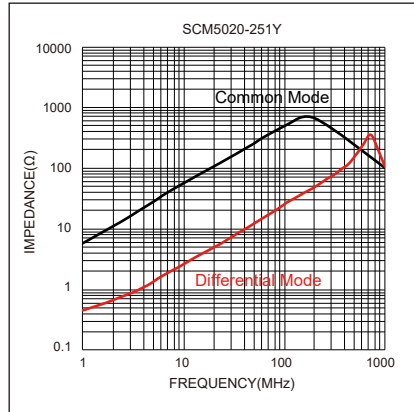
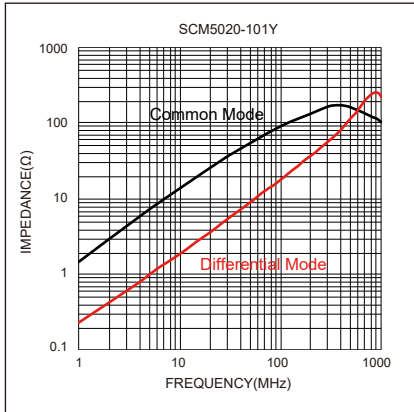

X-ON Electronics

Largest Supplier of Electrical and Electronic Components

Click to view similar products for [Common Mode Chokes / Filters](#) category:

Click to view products by [KOHER](#) manufacturer:

Other Similar products are found below :

[74279408](#) [PE-62911NL](#) [PE-64683](#) [RD5122-6-9M6](#) [RGCMF1210900H3T](#) [ST6118T-R](#) [FE3X025-10-7NL](#) [T8114NLT](#) [RD5122-10-6M0](#)
[TCM0806G-350-2P-T](#) [TCM0806G-650-2P-T](#) [B2013FNLT](#) [IND-0110](#) [UAL21VR0802000](#) [UALSC023000000](#) [UALSC1020JH000](#)
[UALSU10VR15019](#) [UALSU9VD070100](#) [36-00037](#) [5701610000](#) [UALW21HS072450](#) [UALSU9HF050500](#) [UALSU9H0208000](#)
[UAL24VK06450CH](#) [PLT10HH501100PNB](#) [PLT10HH401100PNB](#) [PLT10HH1026R0PNB](#) [PE-67531](#) [TLH10UB](#) [113 0R5](#) [2752045447](#)
[CMS3-11-R](#) [7351V](#) [CMF16-153131](#) [744252510](#) [T8116NLT](#) [CMS2-10-R](#) [FE2X10-4-2NL](#) [744253200](#) [744253101](#) [744252220](#) [TX8111NLT](#)
[UAL30VR3500470](#) [CTX01-19077-R](#) [T8003NLT](#) [CTX01-13663](#) [CTX66-19521-R](#) [7446630047](#) [744136](#) [744150](#) [RC212-0.25-47M](#)