

SPM Series
SMT Power Metal Inductor
Size 4030



CHARACTERISTICS

- Large current, Low DC-resistance, High efficiency by magnetic metal powder
- Low acoustic noise and low leakage flux noise by shielded construction
- Operating temperature: $-40^{\circ}\text{C} \sim 125^{\circ}\text{C}$
- Quantity: 700 pcs/reel

Dimensions: [mm]

Land Pattern: [mm]

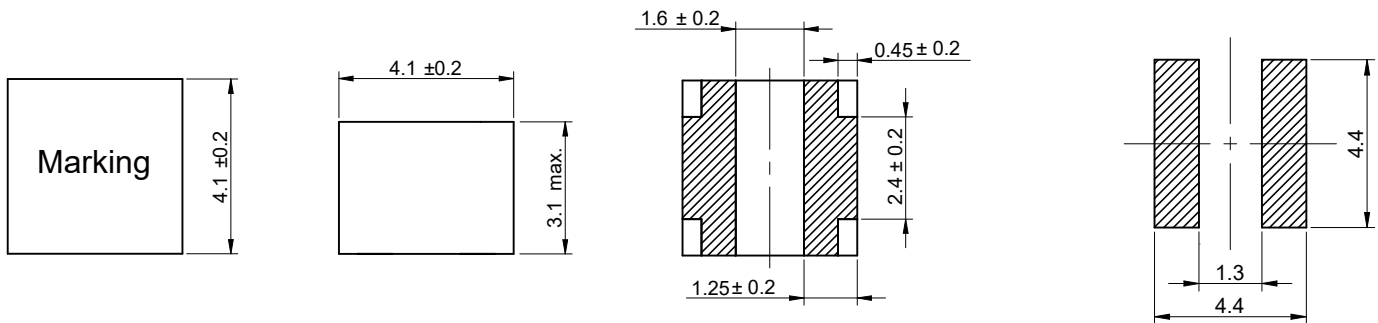

Electrical Properties:

Part No	Inductance (μH)	Tolerance	Temperature Rise Current Typ. (A)	Saturation Current Typ. (A)	DCR Max. (mΩ)	DCR Typ. (mΩ)
SPM4030-1R0M	1.0	± 20%	7.00	7.40	15	12
SPM4030-1R5M	1.5	± 20%	5.90	6.60	20	16
SPM4030-2R2M	2.2	± 20%	5.00	6.00	27	22
SPM4030-4R7M	4.7	± 20%	3.80	5.10	48	40
SPM4030-5R6M	5.6	± 20%	3.60	5.00	56	47
SPM4030-6R8M	6.8	± 20%	2.90	4.40	84	70
SPM4030-100M	10	± 20%	2.40	3.50	120	100

Temperature rise current: the actual value of DC current when the temperature rise is $\Delta T 40^{\circ}\text{C}$
 Saturation Current that will cause initial inductance to drop approximately 20%

Typical Electrical Characteristics:

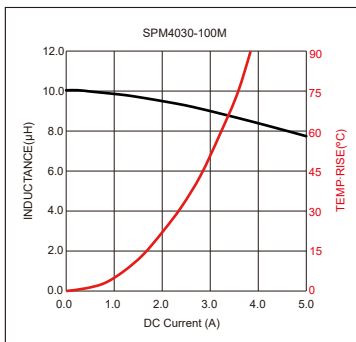
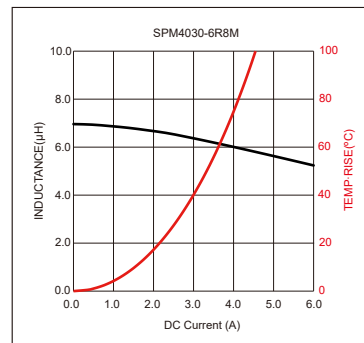
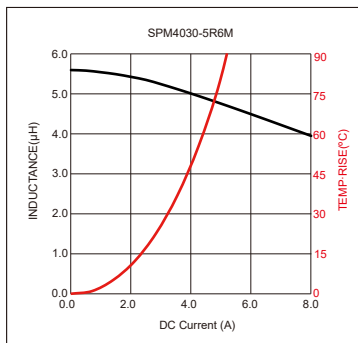
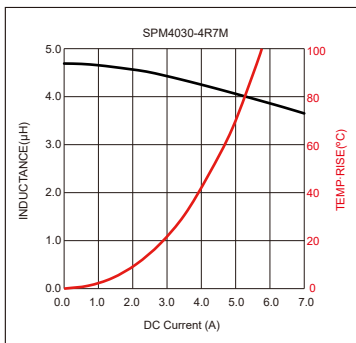
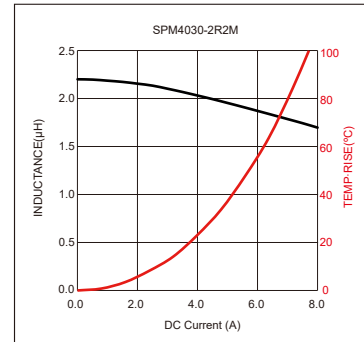
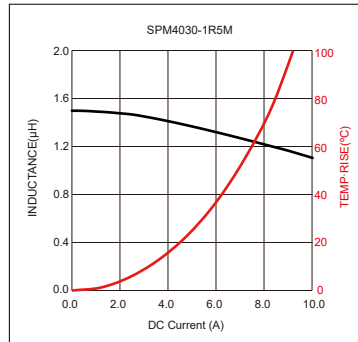
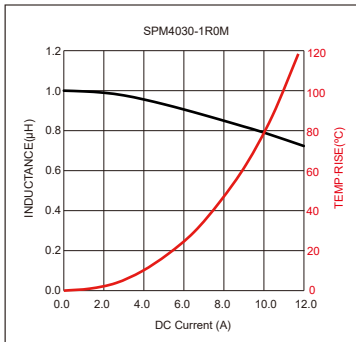

X-ON Electronics

Largest Supplier of Electrical and Electronic Components

Click to view similar products for [Fixed Inductors](#) category:

Click to view products by [KOHER](#) manufacturer:

Other Similar products are found below :

[CR32NP-151KC](#) [CR32NP-180KC](#) [CR32NP-181KC](#) [CR32NP-1R5MC](#) [CR32NP-390KC](#) [CR32NP-3R9MC](#) [CR32NP-680KC](#) [CR32NP-820KC](#) [CR32NP-8R2MC](#) [CR43NP-390KC](#) [CR43NP-560KC](#) [CR43NP-680KC](#) [CR54NP-181KC](#) [CR54NP-470LC](#) [CR54NP-820KC](#) [CR54NP-8R5MC](#) [70F224AI](#) [MGDQ4-00004-P](#) [MHL1ECTTP18NJ](#) [MHQ1005P10NJ](#) [MHQ1005P1N0S](#) [MHQ1005P2N4S](#) [MHQ1005P3N6S](#) [MHQ1005P5N1S](#) [MHQ1005P8N2J](#) [PE-51506NL](#) [PE-53601NL](#) [PE-53602NL](#) [PE-53630NL](#) [PE-53824SNLT](#) [PE-92100NL](#) [PG0434.801NLT](#) [PG0936.113NLT](#) [9220-20](#) [9310-16](#) [PM06-2N7](#) [PM06-39NJ](#) [A01TK](#) [1206CS-471XJ](#) [HC2LP-R47-R](#) [HC2-R47-R](#) [HC3-2R2-R](#) [HCF1305-3R3-R](#) [1206CS-151XG](#) [RCH664NP-140L](#) [RCH664NP-4R7M](#) [RCH8011NP-221L](#) [RCP1317NP-332L](#) [RCP1317NP-391L](#) [RCR1010NP-470M](#)