

A |

All rights reserved, Copyright Kradex 2020

Product model Enclosure IOT.ZPSET1510 - Assembly ZP150.100.60SU TM

Format: A3 Material: PC, ABS

Scale 1:2 Tolerance: +/- 0.5



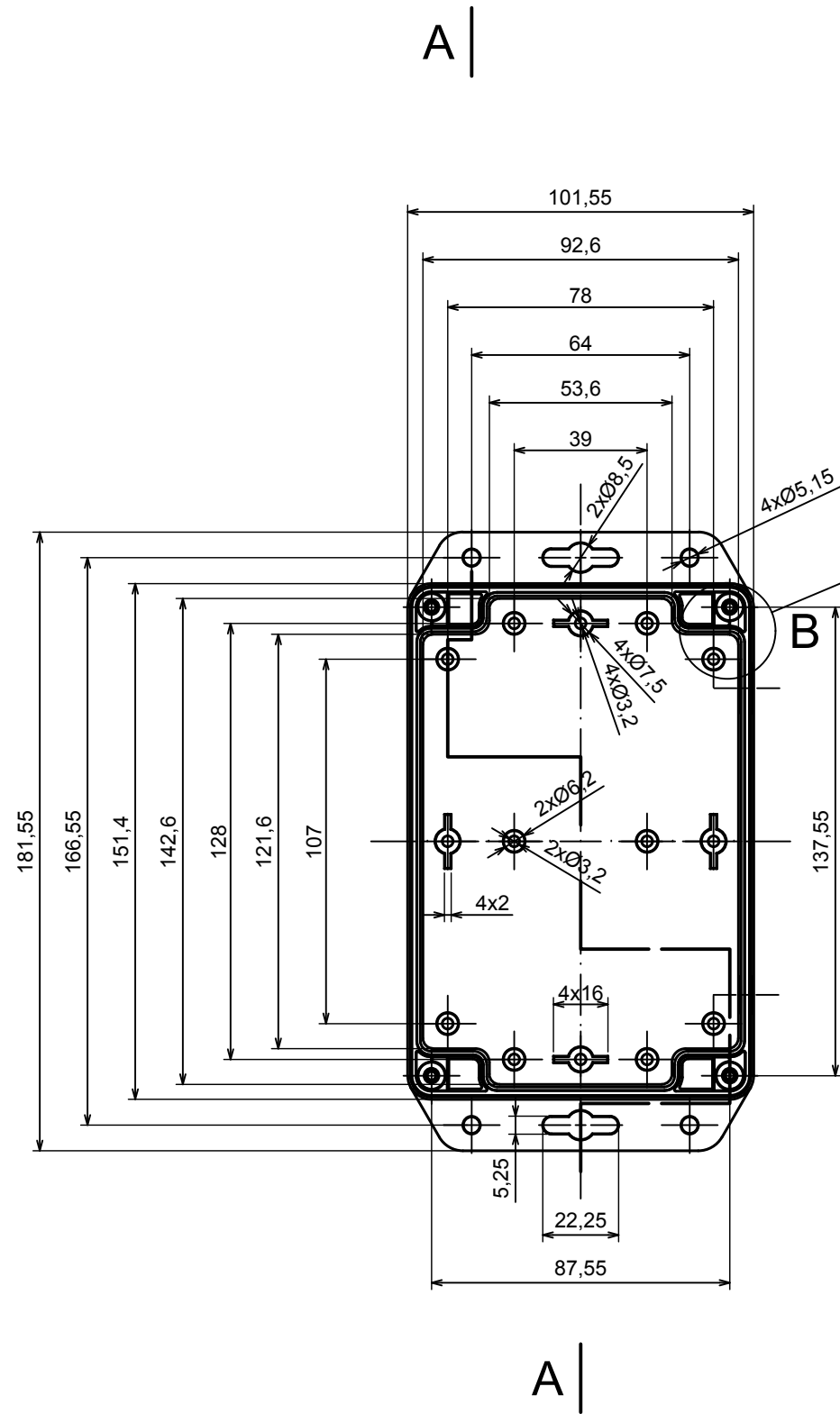

B (1:1)

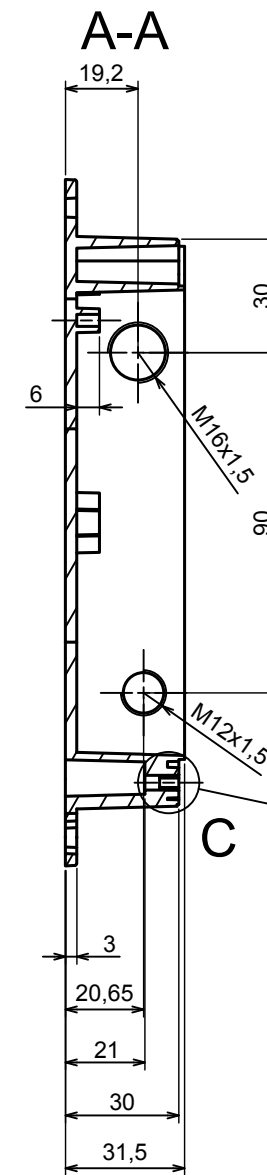
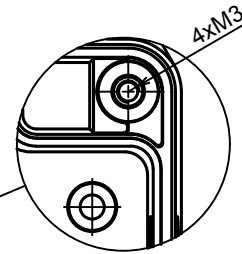

C (1:1)

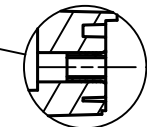

All rights reserved, Copyright Kradex 2020

Product model: Base IOT.ZPSET1510 - Base ZP150.100.30U TM

Format: A3 Material: PC, ABS

Scale 1:2 Tolerance: +/- 0.5



A |

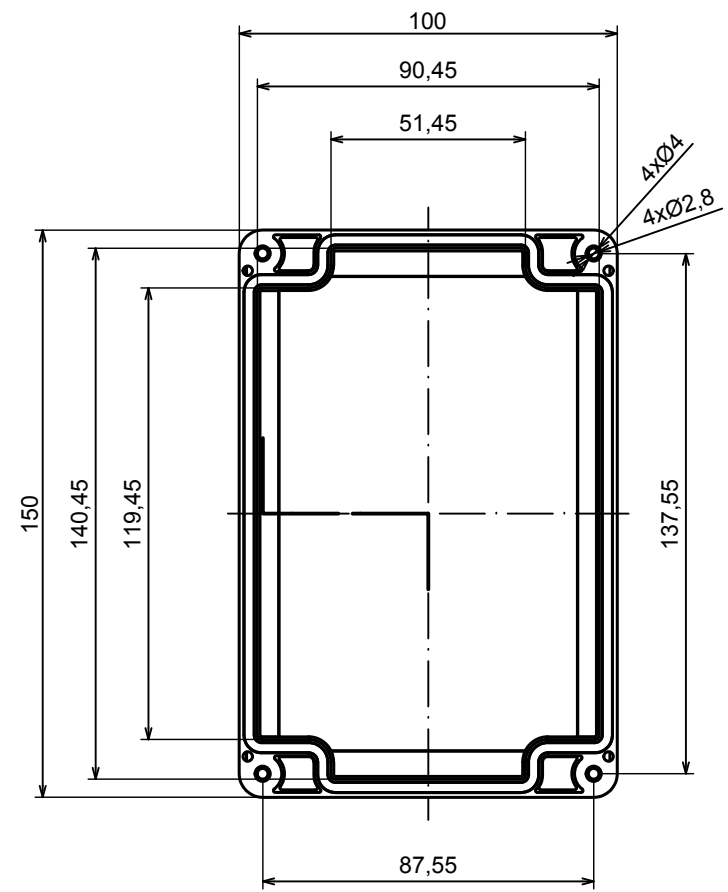

A |

A-A

B (1:1)

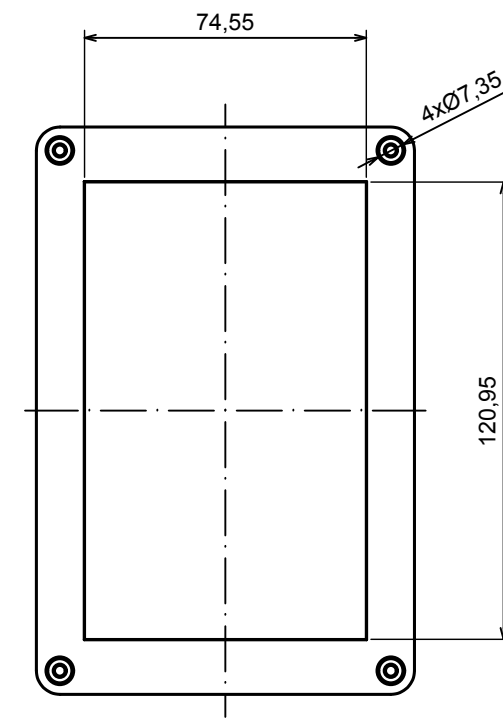
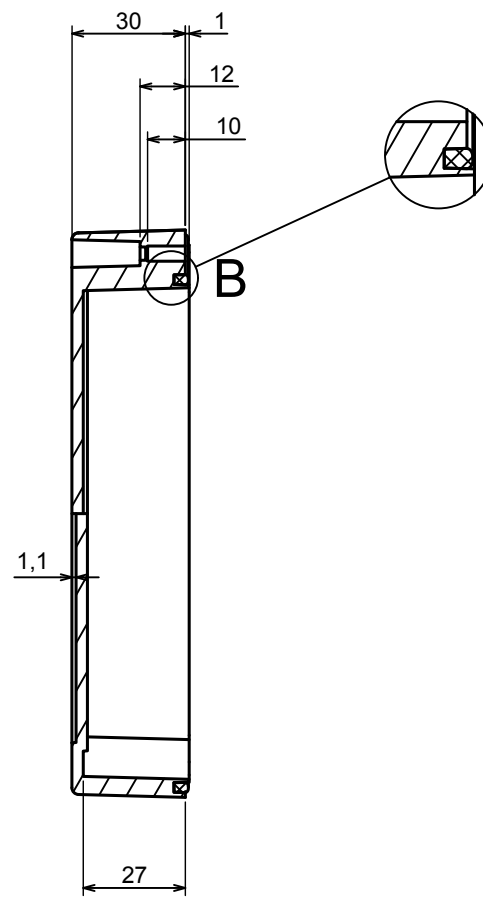

All rights reserved, Copyright Kradox 2020

Product model: Cover IOT.ZPSET1510 - Cover ZP150.100.30S

Format: A3 Material: PC, ABS

Scale 1:2 Tolerance: +/- 0.5



X-ON Electronics

Largest Supplier of Electrical and Electronic Components

Click to view similar products for [Enclosures, Boxes & Cases](#) category:

Click to view products by [Kradex](#) manufacturer:

Other Similar products are found below :

[M-10-PLATED](#) [60221-01](#) [M17-L-PLN](#) [M-21-PLATED](#) [63310-01-000](#) [6711GSKT](#) [90026-501-000](#) [PS36-200](#) [120-407](#) [138-PLAIN](#) [144011](#)
[EAS-500 \(BLACK ANO\)](#) [2062750000](#) [KAB3421](#) [A0645271](#) [1928952](#) [2106-IR](#) [2792057](#) [2906241](#) [2906254](#) [H5031](#) [M-10-LID-PLATED](#)
[CU-284](#) [402-BLACK](#) [MDC-532-PLAIN-ALUM](#) [B137](#) [5400TN](#) [UNC 2-4-6 PLAIN](#) [462-0020E](#) [0542100012](#) [043853](#) [103031](#) [11416P](#) [KR8-](#)
[315](#) [UM-SE-A73-R BK](#) [2202158](#) [TUF 55 25 100 ME](#) [332-907](#) [4122](#) [EKJB](#) [24560-245](#) [736-409](#) [144012](#) [61-9480.6](#) [134573](#) [M18-L-PLTD](#)
[73095-510-000](#) [CNM-0303 Black](#) [S3A-453213-S](#) [ALUG702RD040-IR](#) [07.6370000](#)