

Wszystkie prawa zastrzeżone, Copyright Kradex 2014		
Model produktu	Obudowa Z85 - zestawienie	
Format: A3	Materiał: PS, ABS	
Skala 5:1	Tolerancja: +/- 0,1	

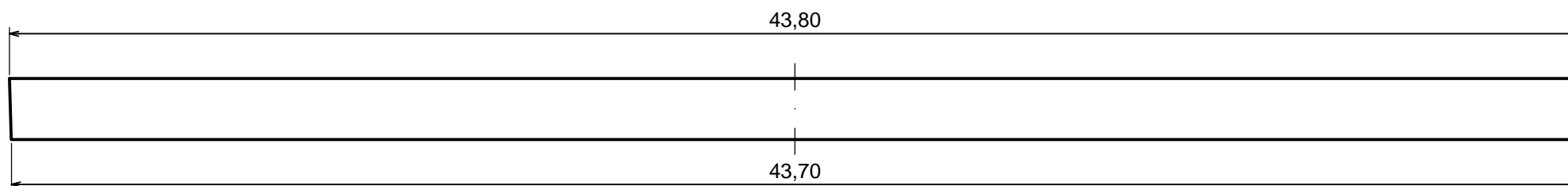
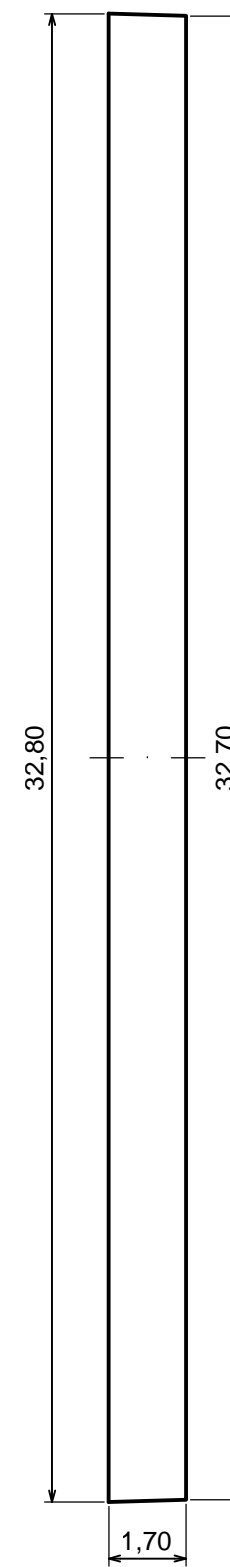
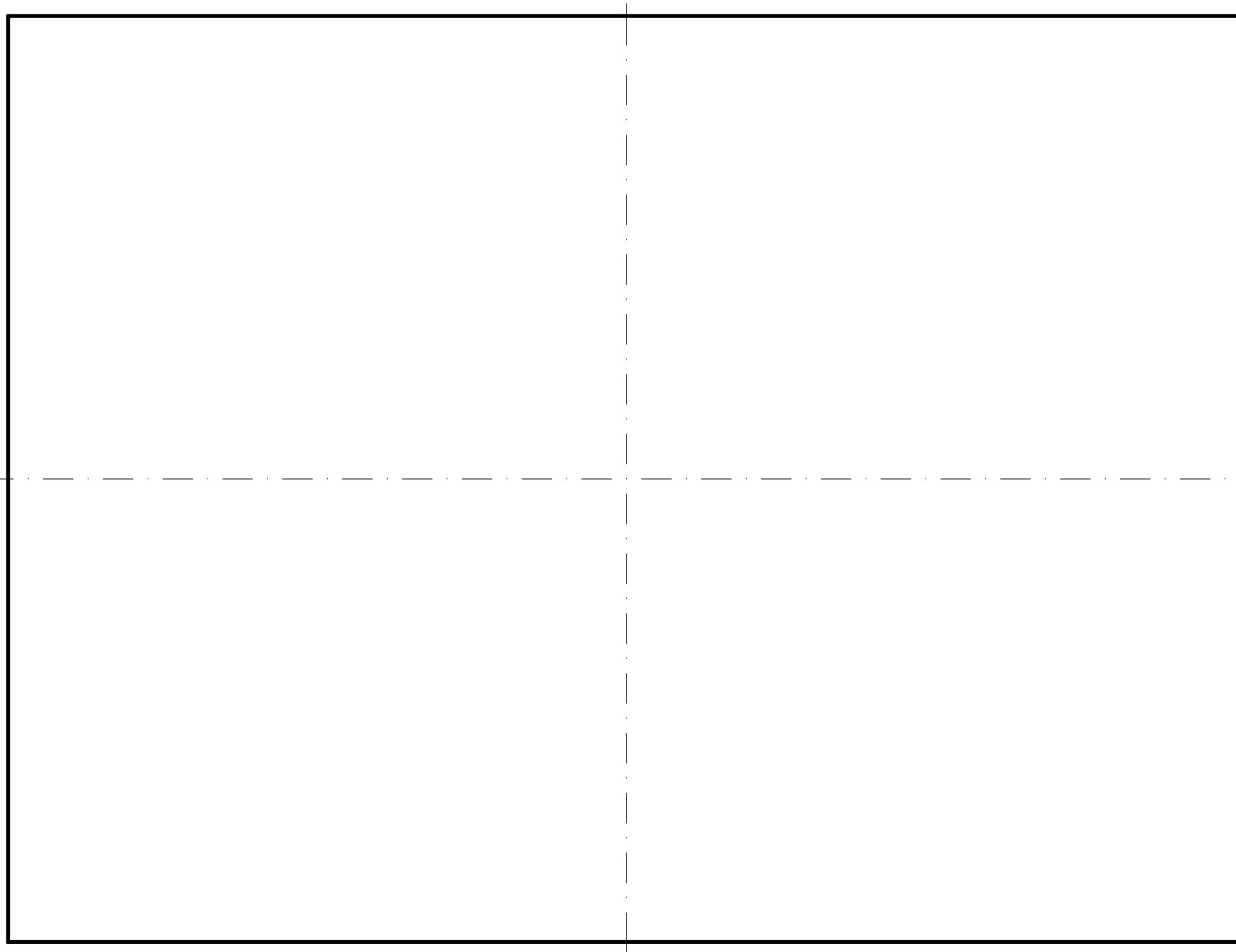

Wszystkie prawa zastrzeżone, Copyright Kradex 2014

Model produktu	Obudowa Z85 - część górna
----------------	---------------------------

Format: A3	Materiał: PS, ABS
------------	-------------------

Skala 6:1	Tolerancja: +/- 0,1
-----------	---------------------



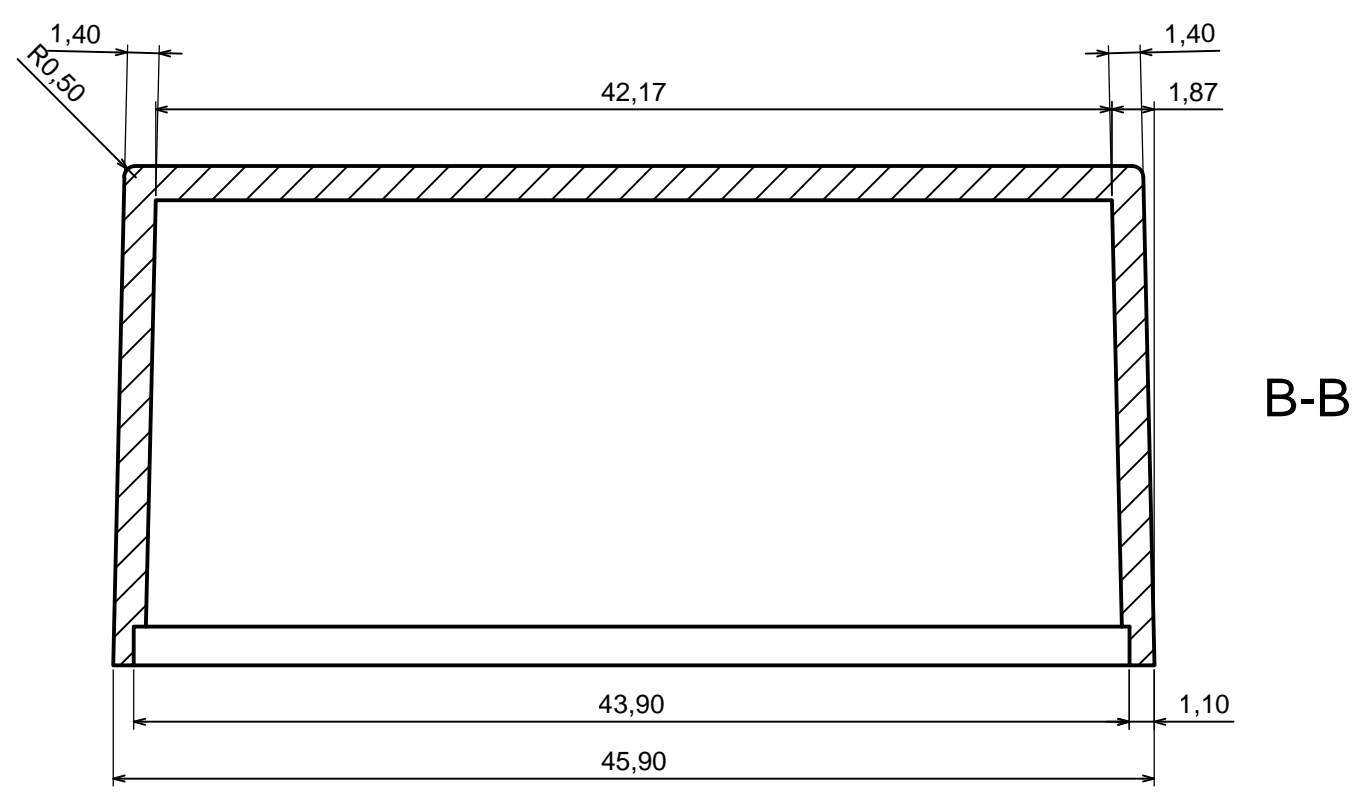
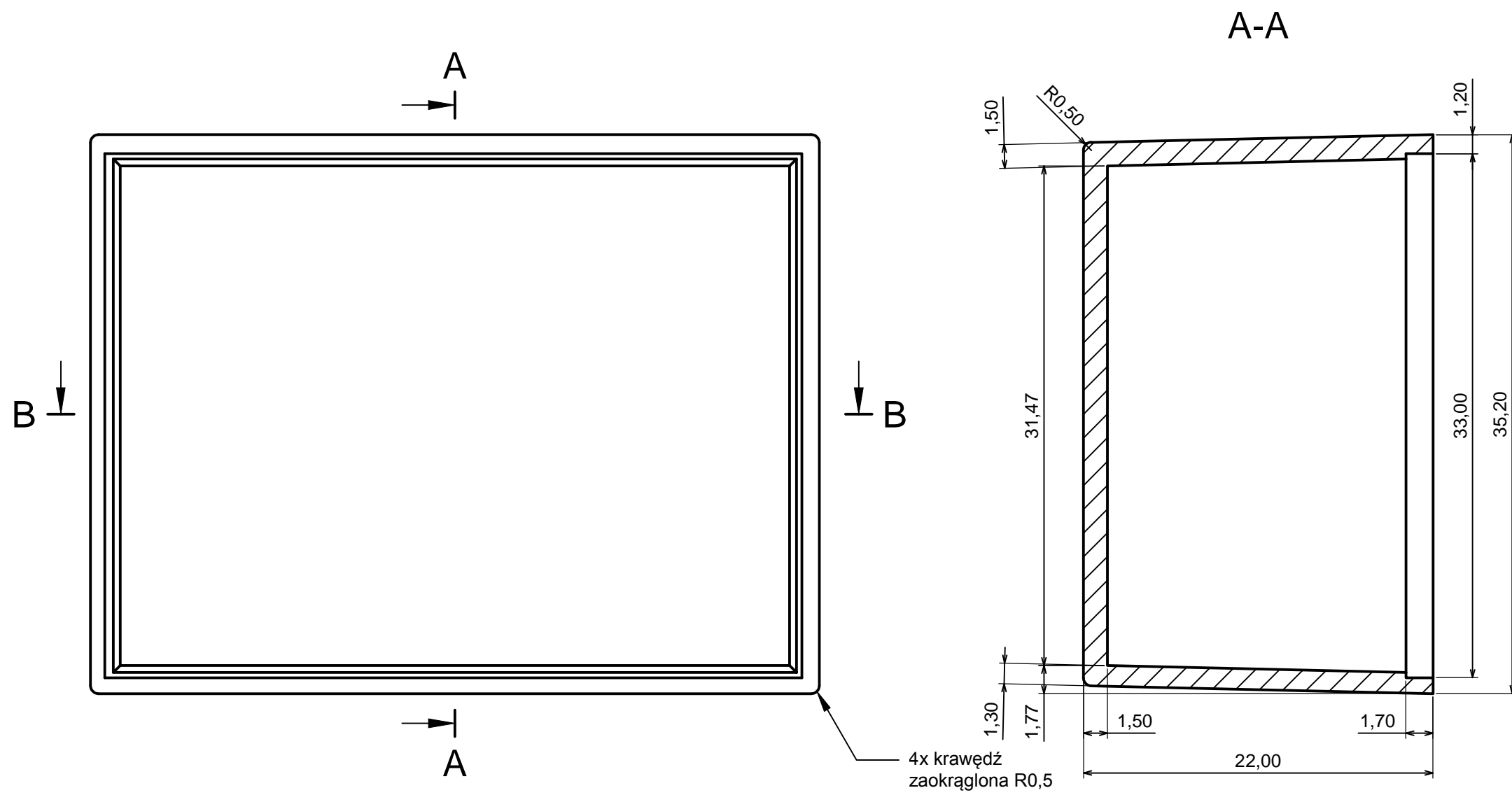

Wszystkie prawa zastrzeżone, Copyright Kradex 2014		
Model produktu	Obudowa Z85 - część dolna	
Format: A3	Materiał: PS, ABS	
Skala 3:1	Tolerancja: +/- 0,1	

## X-ON Electronics

Largest Supplier of Electrical and Electronic Components

*Click to view similar products for [Kradex manufacturer](#):*

Other Similar products are found below :

[Z54JH TM PS](#) [Z78RD](#) [Z47U ABS](#) [Z116JH TM PS](#) [ZP150.100.60UJH TM ABS](#) [Z116JH ABS](#) [Z112B](#) [ZP120.80.60JH TM PC](#)  
[ZP240.190.105JH TM ABS](#) [U Z57](#) [ZP240.190.105SJP TM PC](#) [Z117PH ABS](#) [ZP150.150.60JPH TM PC](#) [IOT.ZPSET1510.1](#)  
[ZP180.120.60UJH TM PC](#) [ZP60.60.40SUJ TM ABS](#) [ZP210.140.45UJPH TM PC](#) [ZP105.105.60JH TM PC](#) [ZDPLUG 5,08 ABS V0](#)  
[ZP180.120.90SJ TM ABS](#) [IOT.ZPSET1510.2](#) [ZD1010-PCB-A0](#) [ZP240.190.105SJP TM ABSPC](#) [Z124J](#) [ZMB120.120](#) [Z98J](#) [Z108J PS](#)  
[ZMB135.135](#) [ZP150.100.75JH TM PC](#) [ZP180.120.90SJ TM PC](#) [ZP240.190.105SJ TM ABS](#) [ZPM5](#) [Z50B ABS](#) [ZP150.100.45SUJP TM](#)  
[ABSPC](#) [ZP150.150.60JPH TM ABS-PC](#) [ZP180.120.90JH TM PC](#) [ZPM1](#) [ZP120.80.60JH TM ABS](#) [ZP180.120.60SUJP TM PC](#) [Z108JFP ABS](#)  
[V0](#) [Z46H ABS](#) [ZP120.120.60JPTMABS-PC](#) [IOT.ZPSET1812.1](#) [ZP210.140.45SUJP TM PC](#) [Z112](#) [ZMB54](#) [ZP150.100.45SUJP TM PC](#)  
[ZP180.120.60UJPH TM PC](#) [ZP210.140.60SJ TM PC](#) [ZLATCH20 ABS](#)