

A |

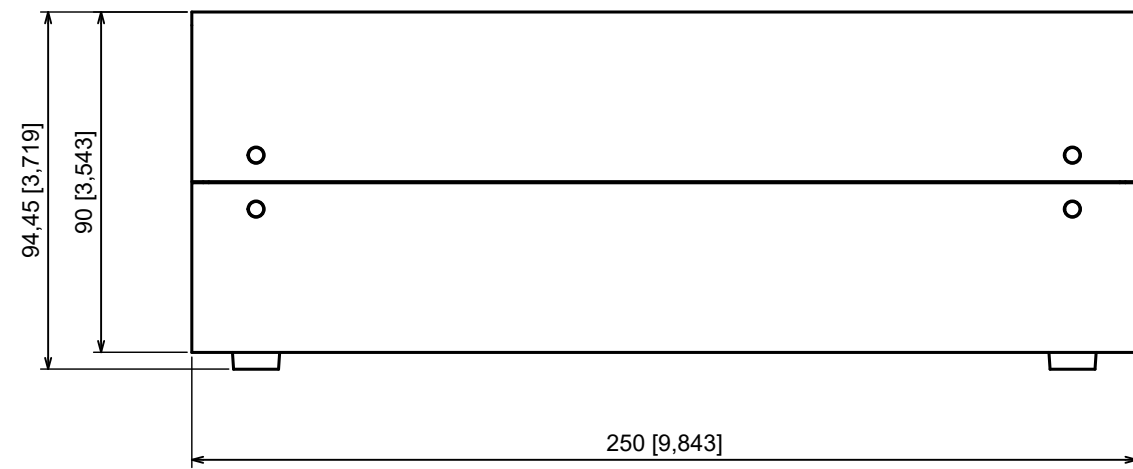

A |

A-A

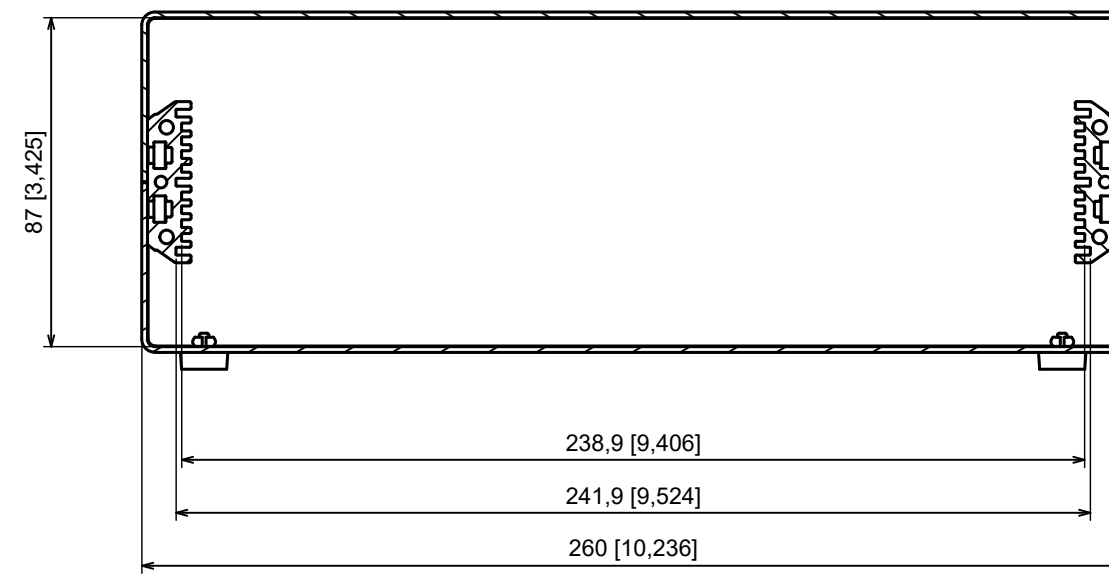

All rights reserved, Copyright Kradex 2023

Product model    Enclosure ZR250.260.90 - Assembly

Format: A3    Material: Al

Scale 1:2    Tolerance: +/- 0.5



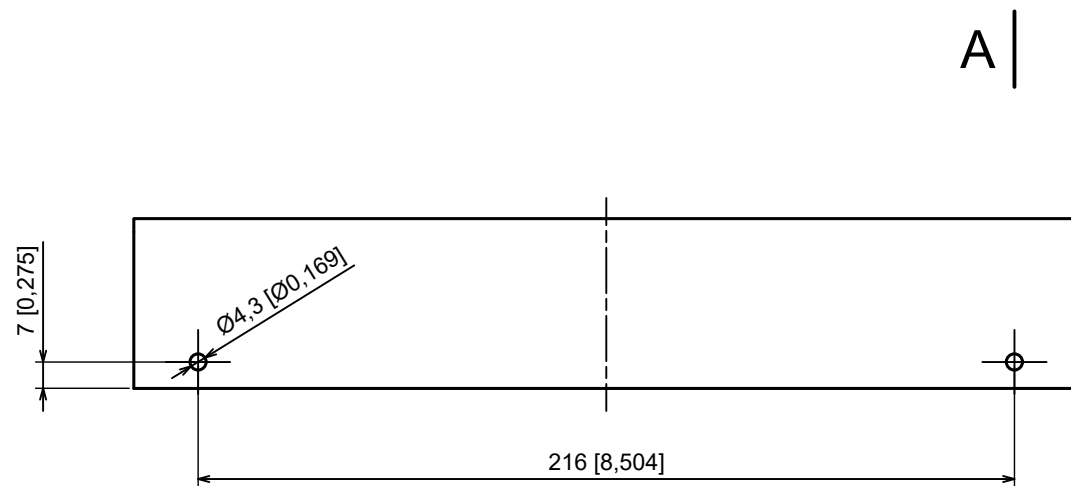
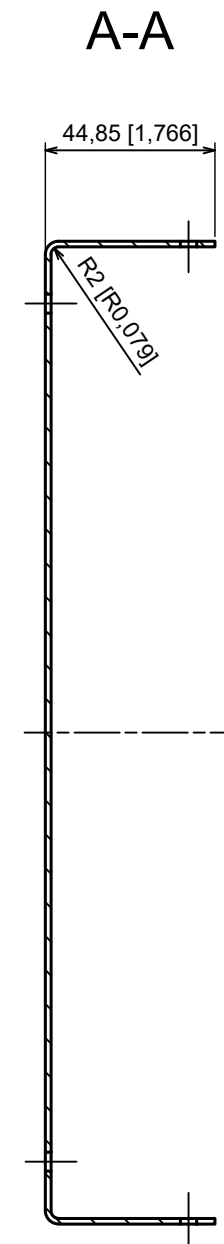
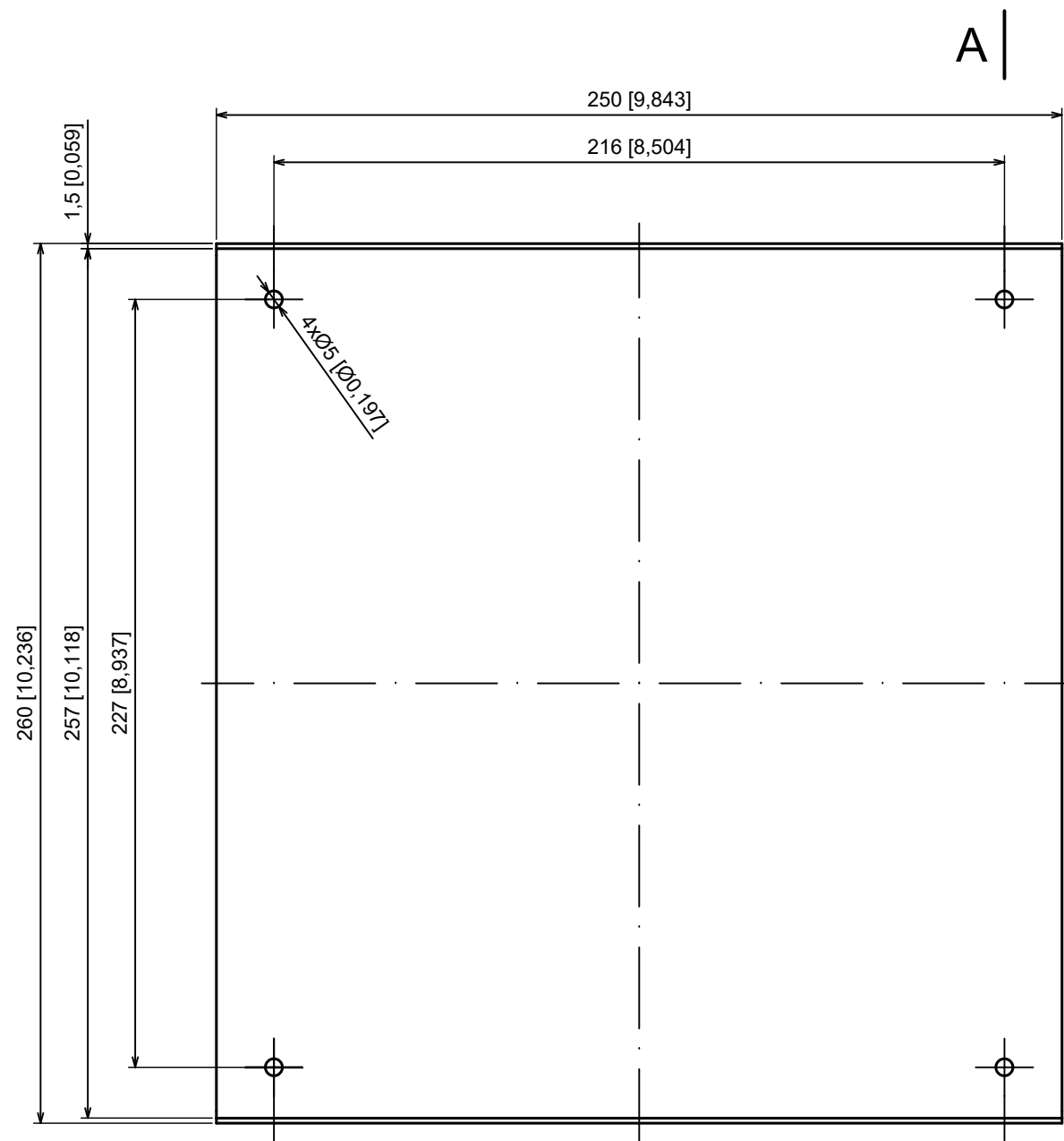

All rights reserved, Copyright Kradox 2023		
Product model	Enclosure ZR250.260.90 - Base	
Format: A3	Material: Al	
Scale 1:2	Tolerance: +/- 0.5	

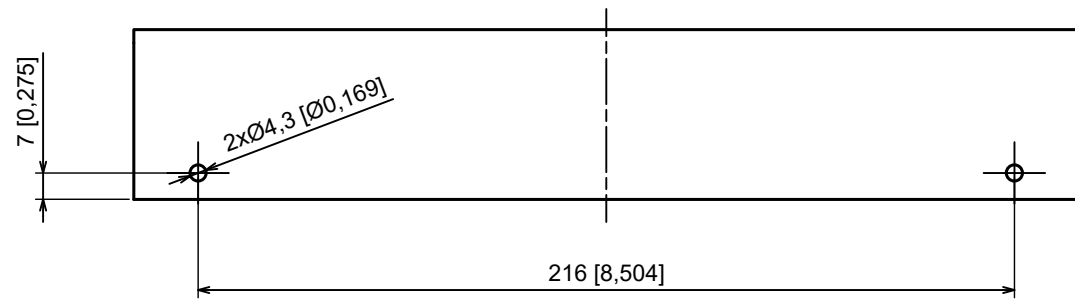
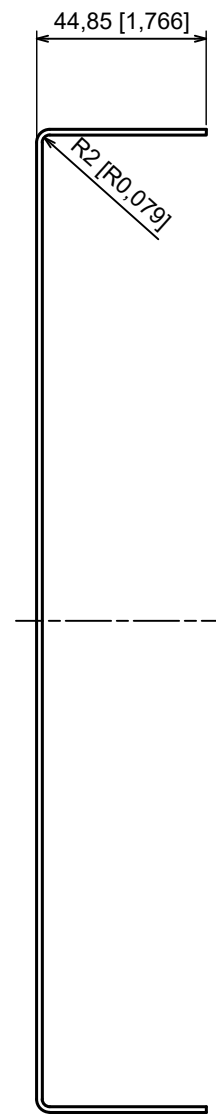
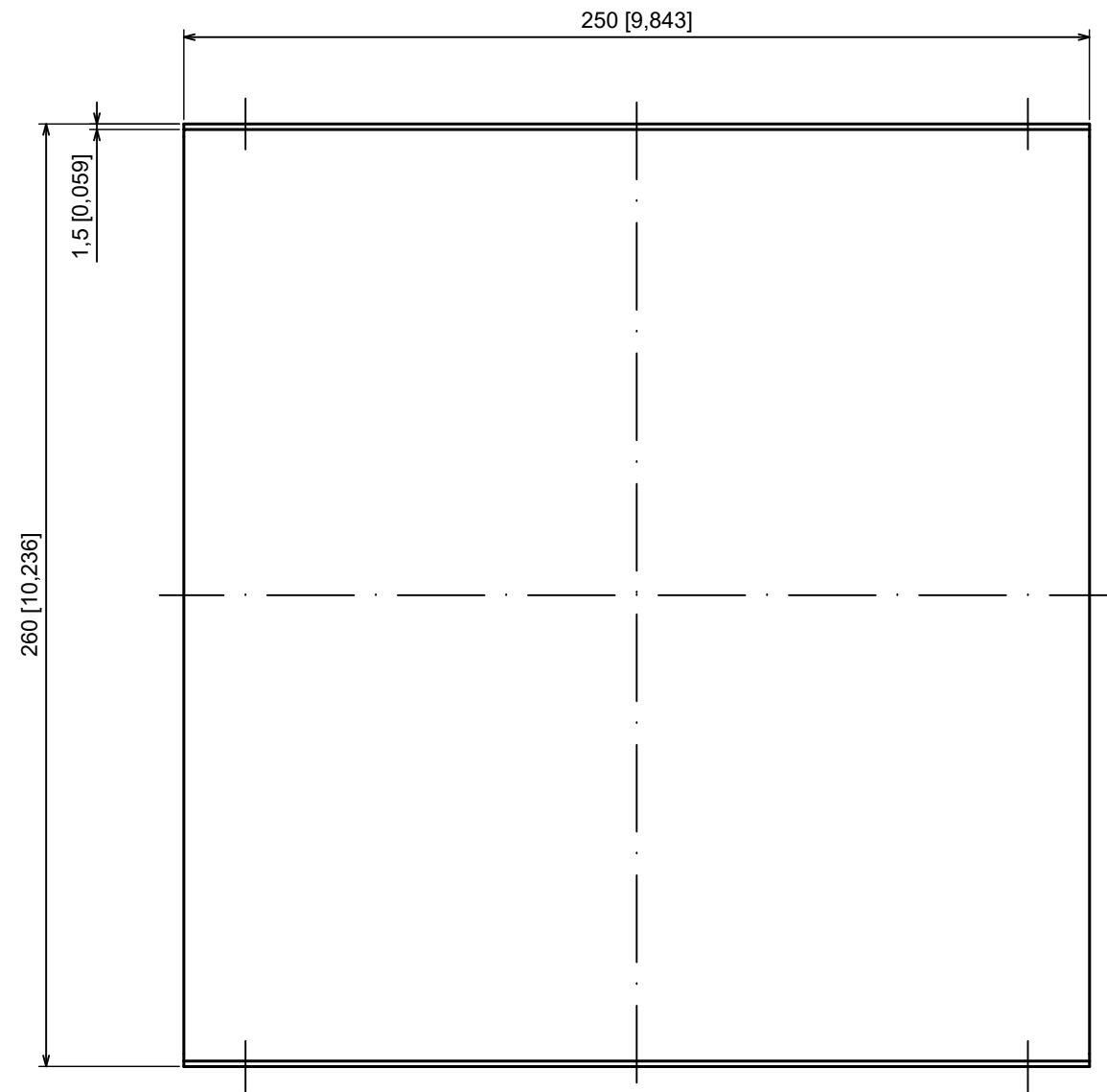

All rights reserved, Copyright Kradox 2023

Product model Enclosure ZR250.260.90 - Cover

Format: A3 Material: Al

Scale 1:2 Tolerance: +/- 0.5



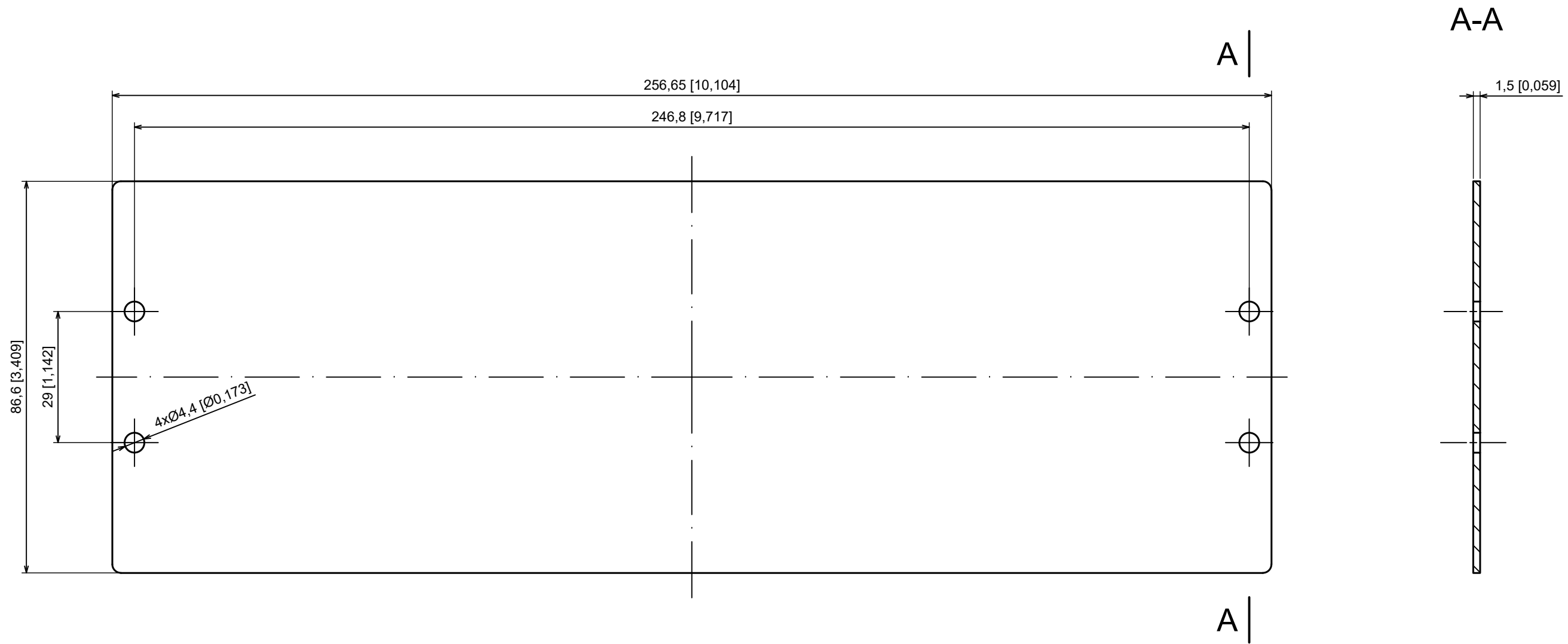

All rights reserved, Copyright Kradox 2023

Product model: Enclosure ZR250.260.90 - Front Panel

Format: A3      Material: Al

Scale 1:1      Tolerance: +/- 0.5



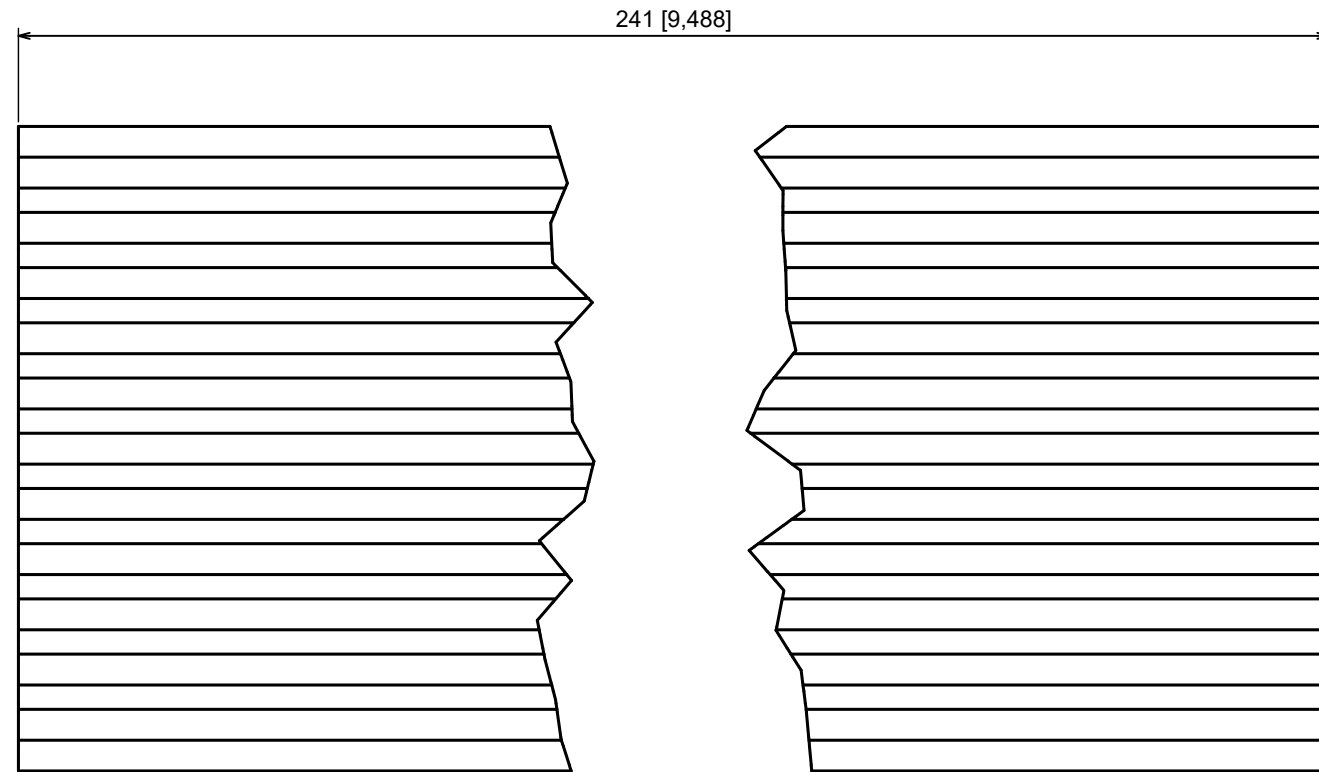
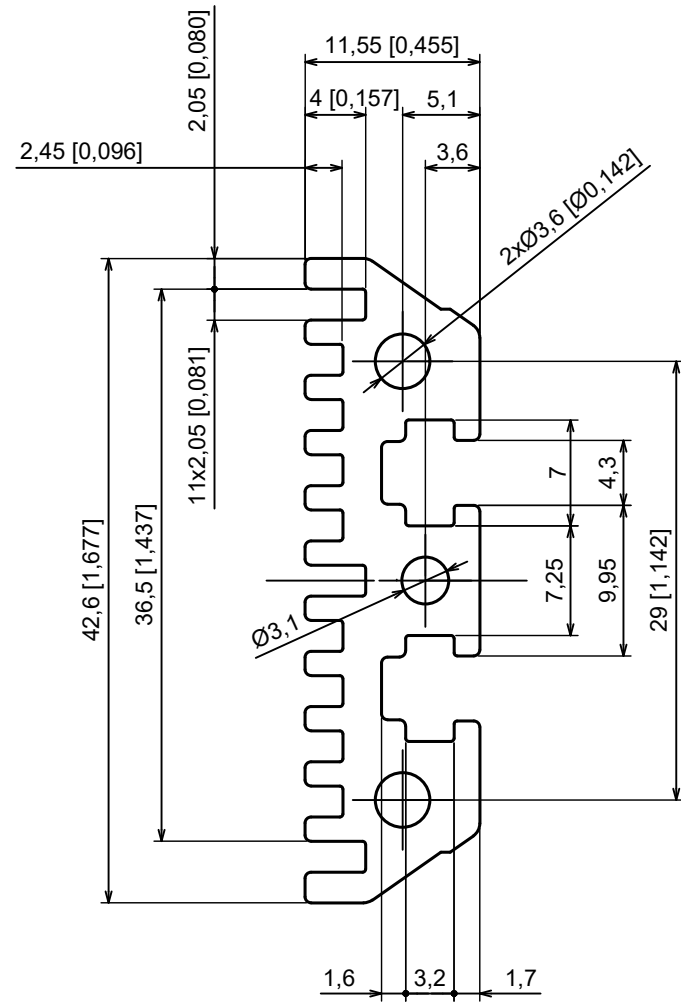

All rights reserved, Copyright Kradox 2023		
Product model	Enclosure ZR250.260.90 - Rail	
Format: A3	Material: Al	
Scale 2:1	Tolerance: +/- 0.5	

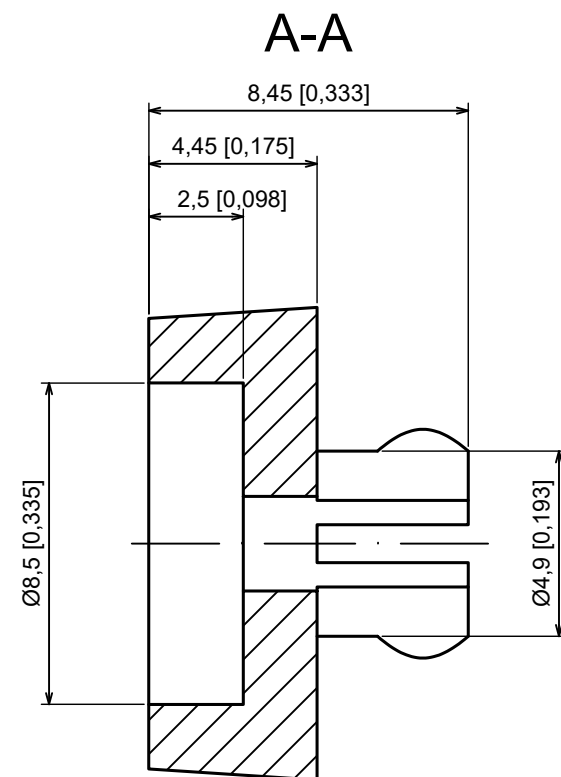
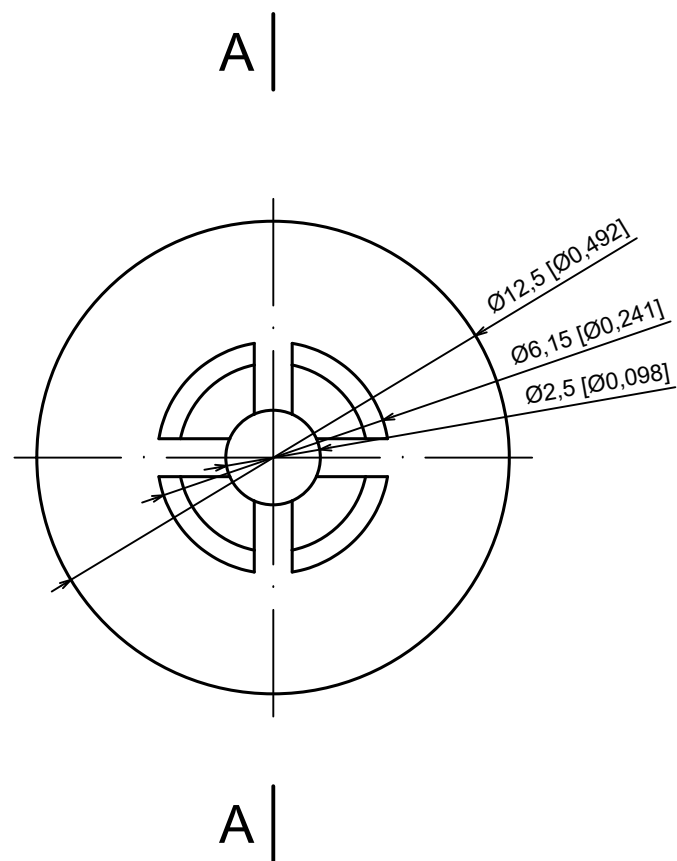

All rights reserved, Copyright Kradex 2023

Product model Enclosure ZR250.260.90 - Foot

Format: A3 Material: PE

Scale 5:1 Tolerance: +/- 0.5



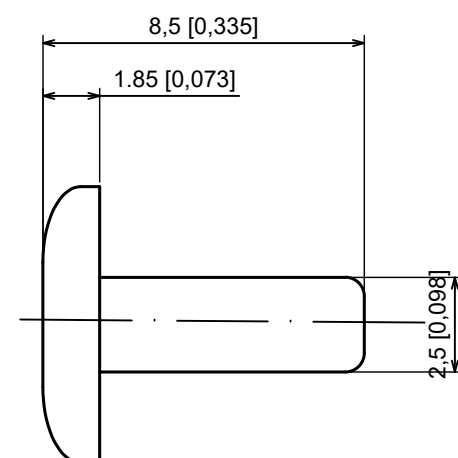
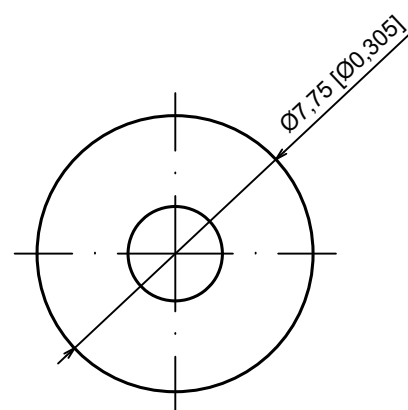

All rights reserved, Copyright Kradox 2023		
Product model	Enclosure ZR250.260.90 - Pin	
Format: A3	Material: PP	
Scale 5:1	Tolerance: +/- 0.5	

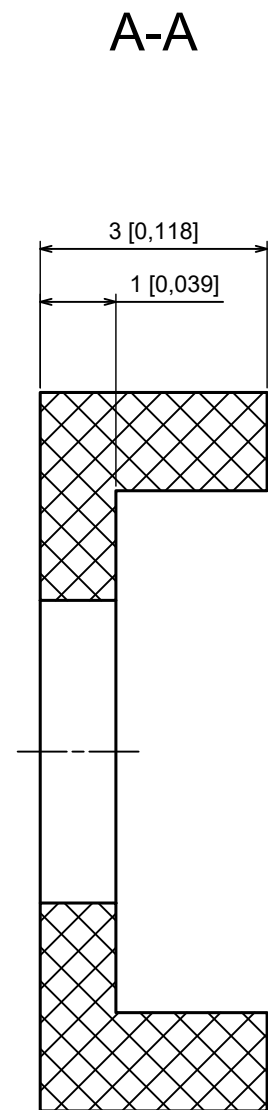
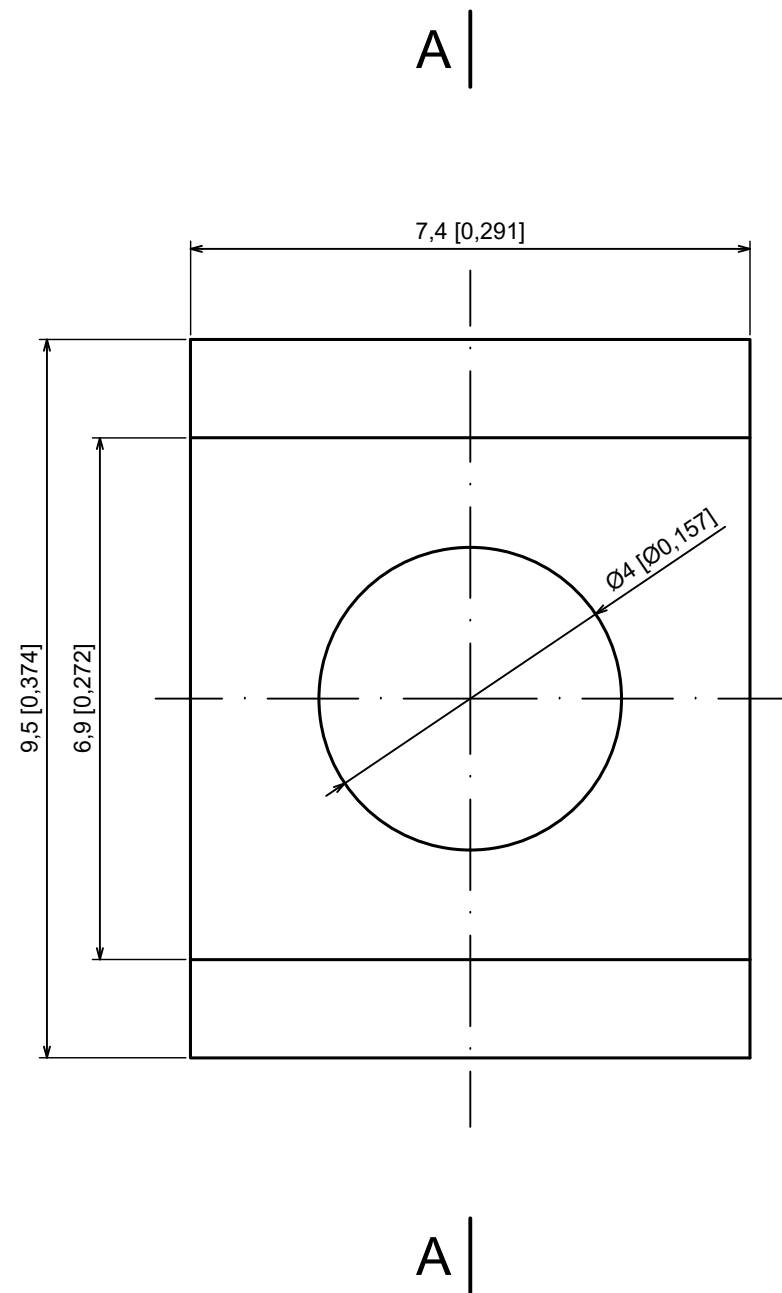

All rights reserved, Copyright Kradox 2023		
Product model	Enclosure ZR250.260.90 - Rubber Pad	
Format: A3	Material: Rubber	
Scale 10:1	Tolerance: +/- 0.5	



## X-ON Electronics

Largest Supplier of Electrical and Electronic Components

*Click to view similar products for [Enclosures, Boxes & Cases](#) category:*

*Click to view products by [Kradex](#) manufacturer:*

Other Similar products are found below :

[M-10-PLATED](#) [60221-01](#) [M17-L-PLN](#) [M-21-PLATED](#) [63310-01-000](#) [6711GSKT](#) [90026-501-000](#) [PS36-200](#) [120-407](#) [138-PLAIN](#) [144011](#)  
[EAS-500 \(BLACK ANO\)](#) [2062750000](#) [KAB3421](#) [A0645271](#) [1928952](#) [2106-IR](#) [2792057](#) [2906241](#) [2906254](#) [2907981](#) [H5031](#) [CU-284](#)  
[MDC-532-PLAIN-ALUM](#) [B137](#) [5400TN](#) [UNC 2-4-6 PLAIN](#) [462-0020E](#) [0542100012](#) [043853](#) [103031](#) [11416P](#) [KR8-315](#) [UM-SE-A73-R](#)  
[BK](#) [2202158](#) [TUF 55 25 100 ME](#) [332-907](#) [4122](#) [52213](#) [24560-245](#) [736-409](#) [144012](#) [61-9480.6](#) [134573](#) [M18-L-PLTD](#) [73095-510-000](#)  
[CNM-0303 Black](#) [S3A-453213-S](#) [ALUG702RD040-IR](#) [07.6370000](#) [P/4.2](#)