



Diodes type D52 are of modern design with internal spring loaded contacts and pressure welded glass-to-metal seal. Designed for use in power electronic circuits and equipment under normal operating conditions.

KEY PARAMETERS

U_{RRM}	up to 1600 V
$I_{F(AV)}$	100 A
I_{FSM}	2100 A

FEATURES

- all diffused design
- high current capabilities
- high surge current capabilities
- high rates voltages
- low thermal impedance
- tested according to IEC standards
- compact size and small weight

APPLICATION

- High Voltage Power Supplies
- Motor Control
- Battery Chargers
- Free Wheeling Diode
- Resistance Welding

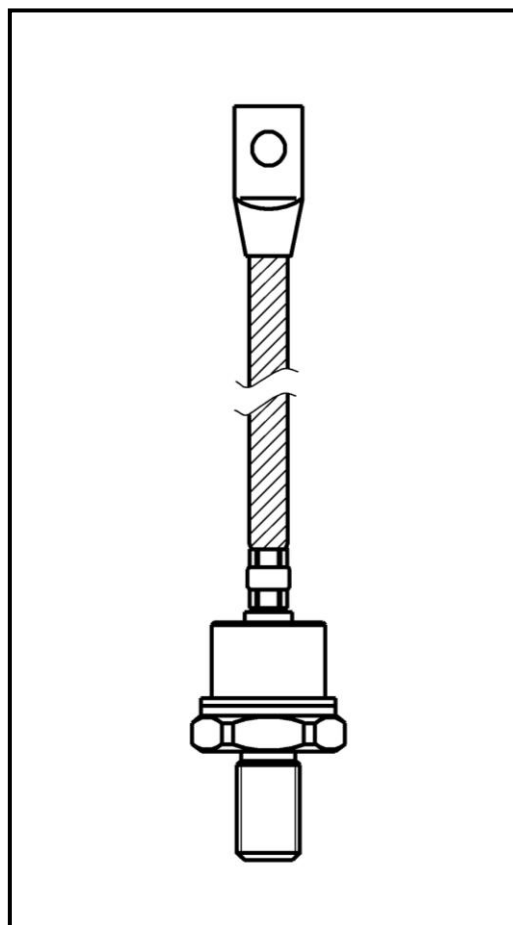

Outline type code: JEDEC DO-205AC

See package details for further information

Designed for use in high power industrial and commercial rectifying circuits where high currents are encountered and high reliability is essential.

D52-100

Diode



KKD52100, October 2006 version

ORDERING INFORMATION

When ordering please refer to device code builder presented below.
Please use the complete part number when ordering, quote or in any future correspondence relating to your order.

D52-100-□□-□0

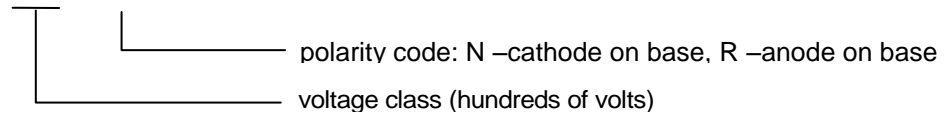

ELECTRICAL PARAMETERS

Voltage ratings

Voltage class	U_{RRM}	U_{RSM}	I_{RRM}
	V	V	mA
04	400	500	20
06	600	700	
08	800	900	
10	1000	1100	
12	1200	1300	
14	1400	1500	
16	1600	1700	

Zakłady Elektronowe LAMINA S.A.
Puławska 34
PL-05-500 Piaseczno
POLAND

Tel.: +48-22-7572731
Tel.: +48-22-3989409
Fax.: +48-22-3989407
e-mail: sekretariat@lamina.com.pl
www.lamina.com.pl

D52-100

Diode



Zakłady Elektronowe
LAMINA S.A.

KKD52100, October 2006 version

Electrical properties

Parameter		Unit	Test conditions	Value			
Average forward current @ case temperature	$I_{F(AV)}$	A		100			
	T_C	°C		<table border="1"> <tr> <td>$U_{RRM} \leq 1200V$</td> <td>140</td> </tr> <tr> <td>$U_{RRM} > 1200V$</td> <td>125</td> </tr> </table>	$U_{RRM} \leq 1200V$	140	$U_{RRM} > 1200V$
$U_{RRM} \leq 1200V$	140						
$U_{RRM} > 1200V$	125						
RMS forward current	$I_{F(RMS)}$	A		157			
Surge current	I_{FSM}	A	$T_j = T_{jmax}$, $U_R = 0,8U_{RRM}$, $t_p = 10ms$	2100			
I^2t – value	I^2t	kA ² s		22			
Forward voltage drop max.	U_{FM}	V	$T_j = 25^\circ C$, $I_{FM} = 470A$	2,20			
Threshold voltage	$U_{F(T0)}$	V		1,20			
Slope resistance	r_F	mΩ		2,37			

Thermal properties

Parameter		Unit	Test conditions	Value				
Thermal resistance, junction to case	R_{thJC}	°C/W	DC	0,25				
Thermal resistance, case to heatsink	R_{thCS}	°C/W		0,12				
Operating junction temperature	$T_{jmin} \dots T_{jmax}$	°C		<table border="1"> <tr> <td>$U_{RRM} \leq 1200V$</td> <td>-40...+190</td> </tr> <tr> <td>$U_{RRM} > 1200V$</td> <td>-40...+175</td> </tr> </table>	$U_{RRM} \leq 1200V$	-40...+190	$U_{RRM} > 1200V$	-40...+175
$U_{RRM} \leq 1200V$	-40...+190							
$U_{RRM} > 1200V$	-40...+175							
Storage temperature	T_{stg}	°C		-40...+190				

Mechanical properties

Parameter		Unit	Value
Mounting torque	M	Nm	14 ... 17
Weight	m	g	130

Zakłady Elektronowe LAMINA S.A.
Puławska 34
PL-05-500 Piaseczno
POLAND

Tel.: +48-22-7572731
Tel.: +48-22-3989409
Fax.: +48-22-3989407
e-mail: sekretariat@lamina.com.pl
www.lamina.com.pl

D52-100

Diode

KKD52100, October 2006 version

Package details

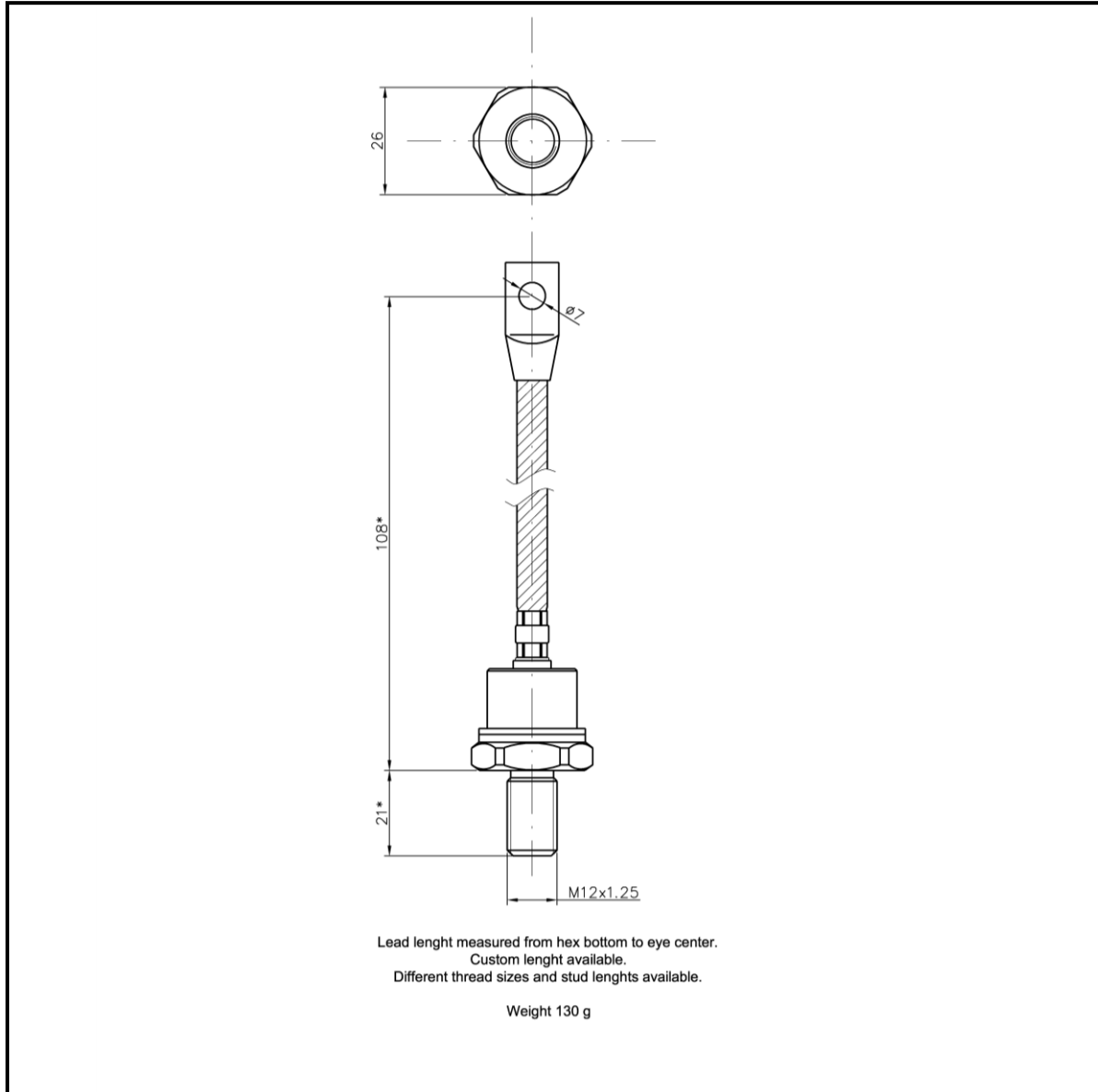

For further package information, please contact Sales & Marketing Department. All dimensions in mm, unless stated otherwise.
Do not scale.

Zakłady Elektroniczne LAMINA S.A.
Puławska 34
PL-05-500 Piaseczno
POLAND

Tel.: +48-22-7572731
Tel.: +48-22-3989409
Fax.: +48-22-3989407
e-mail: sekretariat@lamina.com.pl
www.lamina.com.pl

D52-100

Diode

KKD52100, October 2006 version

CHARACTERISTICS

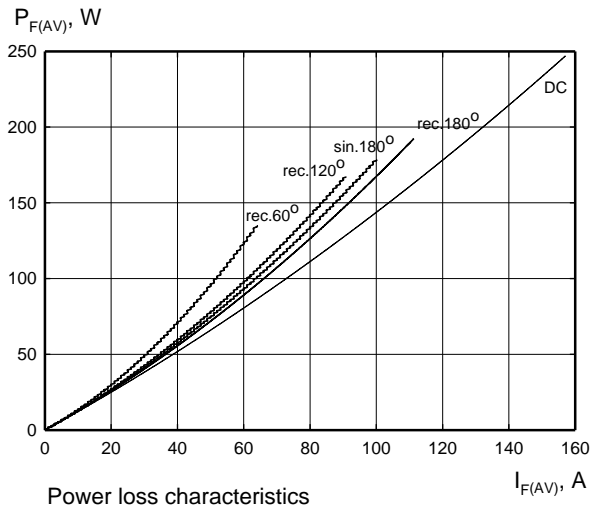

Power loss characteristics

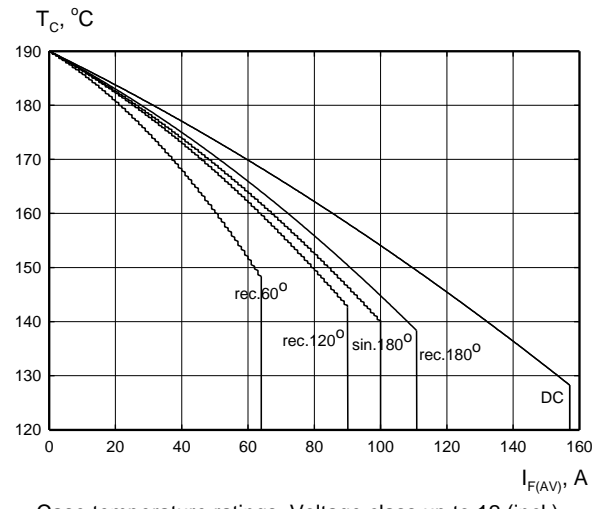

Case temperature ratings. Voltage class up to 12 (incl.)

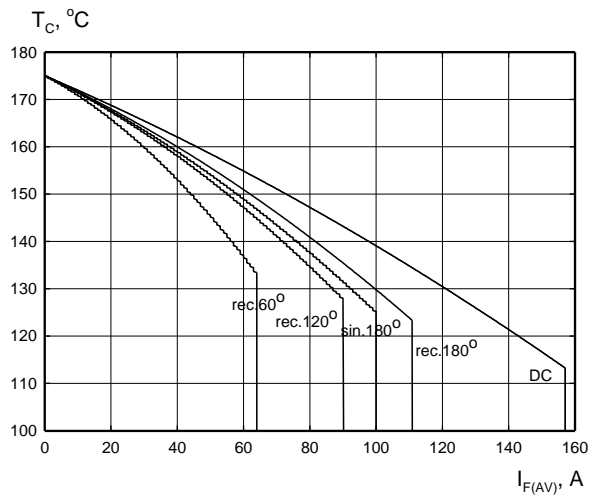

Case temperature ratings. Voltage class > 12

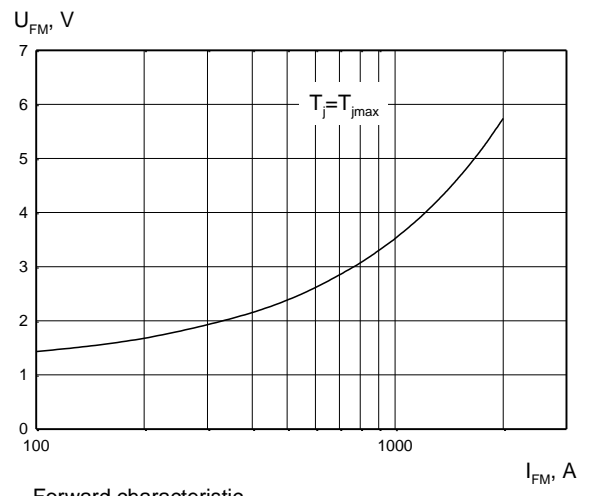

Forward characteristic

D52-100

Diode

KKD52100, October 2006 version

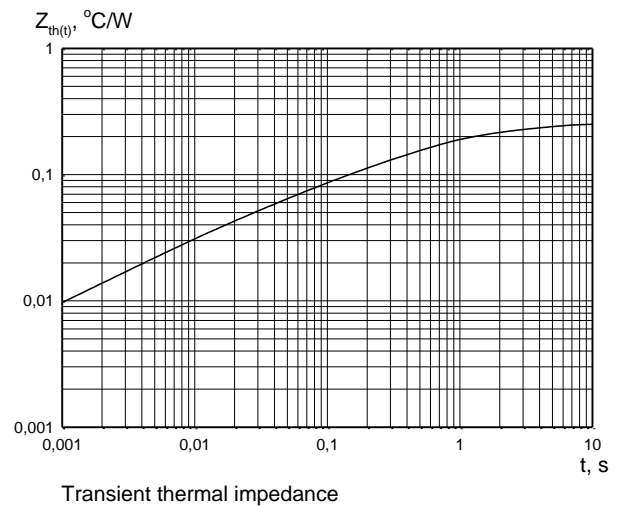
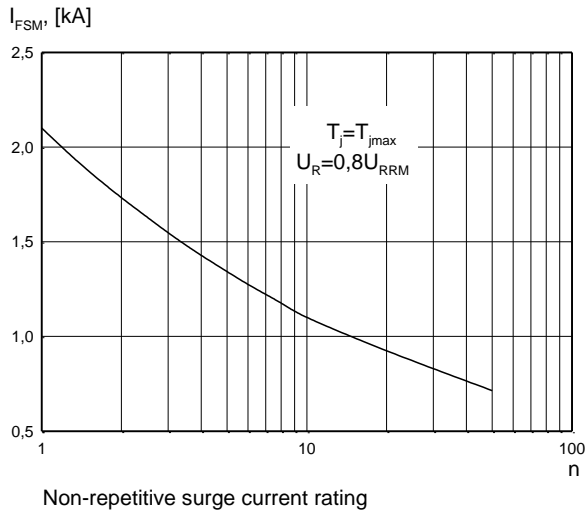

HEATSINKS

LAMINA S.I. has its own proprietary range of extruded aluminium heatsinks designed to optimise the performance of our semiconductors with natural and forced air flow.

POWER ASSEMBLY CAPABILITY

LAMINA S.I. provides a support for those customers requiring more than a basic semiconductor and offers precisely assembled Power Blocks according to factory or customer standards.

X-ON Electronics

Largest Supplier of Electrical and Electronic Components

Click to view similar products for [Rectifiers](#) category:

Click to view products by [KUBARA LAMINA](#) manufacturer:

Other Similar products are found below :

[70HFR40](#) [RL252-TP](#) [1N5397](#) [NTE5841](#) [NTE6038](#) [SCF5000](#) [1N4002G](#) [1N4005-TR](#) [JANS1N6640US](#) [481235F](#) [RRE02VS6SGTR](#) [067907F](#)
[MS306](#) [70HF40](#) [US2JFL-TP](#) [A1N5404G-G](#) [CRS04\(T5L,TEMQ\)](#) [ACGRA4007-HF](#) [ACGRB207-HF](#) [CLH03\(TE16L,Q\)](#) [ACGRC307-HF](#)
[ACEFC304-HF](#) [NTE6356](#) [NTE6359](#) [NTE6002](#) [NTE6023](#) [NTE6039](#) [NTE6077](#) [85HFR60](#) [40HFR60](#) [1N1186RA](#) [70HF120](#) [85HFR80](#)
[D126A45C](#) [SCF7500](#) [D251N08B](#) [SCHJ22.5K](#) [SM100](#) [SCPA2](#) [SDHD5K](#) [VS-12FL100S10](#) [ACGRA4001-HF](#) [D1821SH45T PR](#) [D1251S45T](#)
[NTE5990](#) [NTE6358](#) [NTE6162](#) [NTE5850](#) [SKN20/08](#) [SKN300/16](#)