



Diodes type D66 are of modern design with internal spring loaded contacts and pressure welded glass-to-metal seal. Designed for use in power electronic circuits and equipment under normal operating conditions.

### KEY PARAMETERS

$U_{RRM}$	up to 1600 V
$I_{F(AV)}$	320 A
$I_{FSM}$	6300 A

### FEATURES

- all diffused design
- high current capabilities
- high surge current capabilities
- high rates voltages
- low thermal impedance
- tested according to IEC standards
- compact size and small weight

### APPLICATION

- High Voltage Power Supplies
- Motor Control
- Battery Chargers
- Free Wheeling Diode
- Resistance Welding

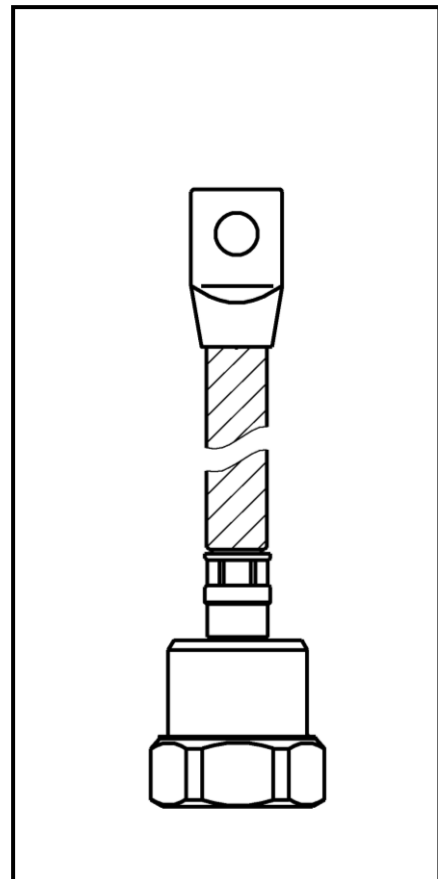

See package details for further information

Designed for use in high power industrial and commercial power electronic circuits and equipment where high currents are encountered and high reliability is essential.

# D66-320

## Diode



KKD66320, October 2006 version

### ORDERING INFORMATION

When ordering please refer to device code builder presented below.  
Please use the complete part number when ordering, quote or in any future correspondence relating to your order.

**D66-320-**   -  **0**

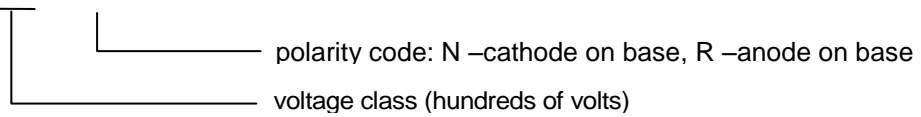

### ELECTRICAL PARAMETERS

#### Voltage ratings

Voltage class	$U_{RRM}$	$U_{RSM}$	$I_{RRM}$
	V	V	mA
04	400	500	50
06	600	700	
08	800	900	
10	1000	1100	
12	1200	1300	
14	1400	1500	
16	1600	1700	

**Zakłady Elektronowe LAMINA S.A.**  
Puławska 34  
PL-05-500 Piaseczno  
POLAND

Tel.: +48-22-7572731  
Tel.: +48-22-3989409  
Fax.: +48-22-3989407  
e-mail: sekretariat@lamina.com.pl  
www.lamina.com.pl

# D66-320

## Diode

KKD66320, October 2006 version

### Electrical properties

Parameter		Unit	Test conditions	Value			
Average forward current @ case temperature	$I_{F(AV)}$	A		320			
	$T_c$	°C		<table border="1"> <tr> <td><math>U_{RRM} \leq 1200V</math></td> <td>125</td> </tr> <tr> <td><math>U_{RRM} &gt; 1200V</math></td> <td>110</td> </tr> </table>	$U_{RRM} \leq 1200V$	125	$U_{RRM} > 1200V$
$U_{RRM} \leq 1200V$	125						
$U_{RRM} > 1200V$	110						
RMS forward current	$I_{F(RMS)}$	A		502			
Surge current	$I_{FSM}$	A	$T_j = T_{jmax}$ , $U_R = 0,8U_{RRM}$ , $t_p = 10ms$	6300			
$I^2t$ – value	$I^2t$	$kA^2s$		198			
Forward voltage drop max.	$U_{FM}$	V	$T_j = 25^\circ C$ , $I_{FM} = 800A$	1,40			
Threshold voltage	$U_{F(T0)}$	V		0,69			
Slope resistance	$r_F$	mΩ		0,99			

### Thermal properties

Parameter		Unit	Test conditions	Value				
Thermal resistance, junction to case	$R_{thJC}$	°C/W	DC	0,12				
Thermal resistance, case to heatsink	$R_{thCS}$	°C/W		0,10				
Operating junction temperature	$T_{jmin} \dots T_{jmax}$	°C		<table border="1"> <tr> <td><math>U_{RRM} \leq 1200V</math></td> <td>-40...+190</td> </tr> <tr> <td><math>U_{RRM} &gt; 1200V</math></td> <td>-40...+175</td> </tr> </table>	$U_{RRM} \leq 1200V$	-40...+190	$U_{RRM} > 1200V$	-40...+175
$U_{RRM} \leq 1200V$	-40...+190							
$U_{RRM} > 1200V$	-40...+175							
Storage temperature	$T_{stg}$	°C		-40...+190				

### Mechanical properties

Parameter		Unit	Value
Mounting force	F	kN	3,5
Weight	m	g	200

# D66-320

## Diode

KKD66320, October 2006 version

### Package details

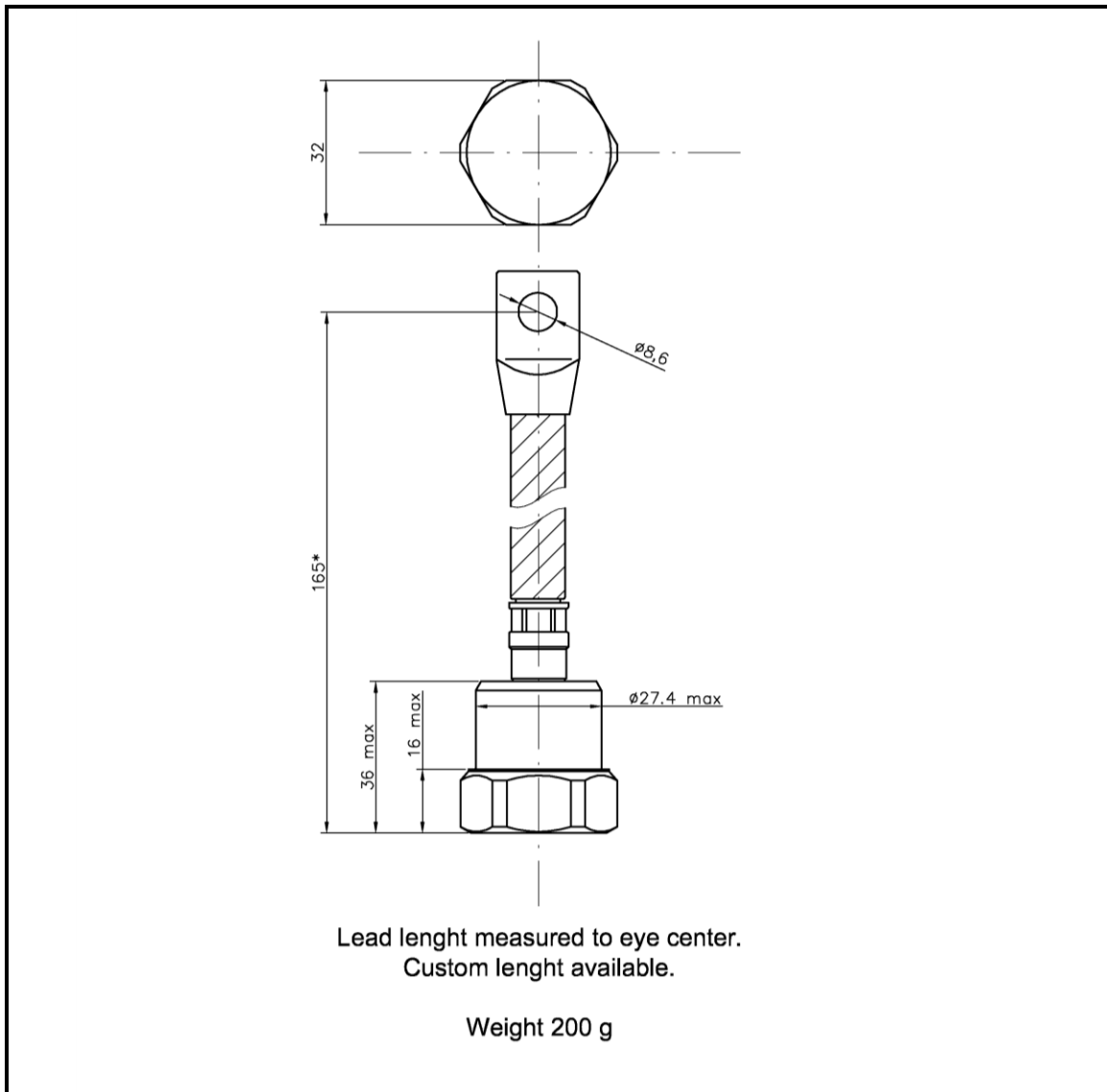

For further package information, please contact Sales & Marketing Department. All dimensions in mm, unless stated otherwise.  
Do not scale.

**Zakłady Elektroniczne LAMINA S.A.**  
Puławska 34  
PL-05-500 Piaseczno  
POLAND

Tel.: +48-22-7572731  
Tel.: +48-22-3989409  
Fax.: +48-22-3989407  
e-mail: sekretariat@lamina.com.pl  
www.lamina.com.pl

# D66-320

## Diode

KKD66320, October 2006 version

### CHARACTERISTICS

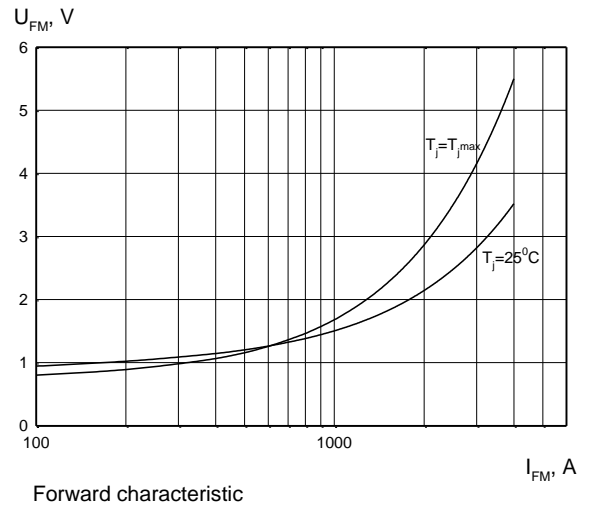
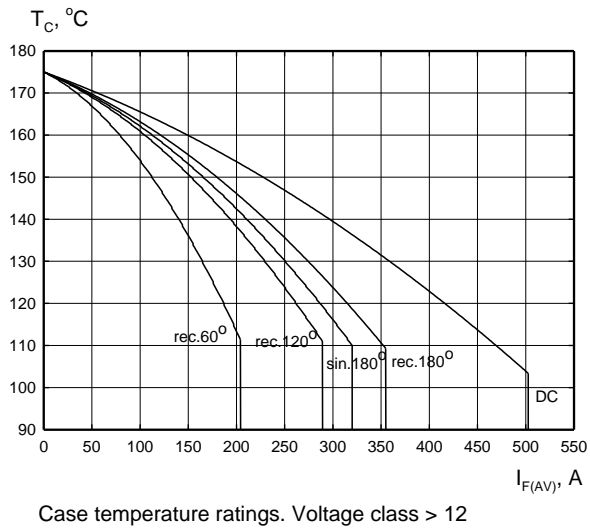
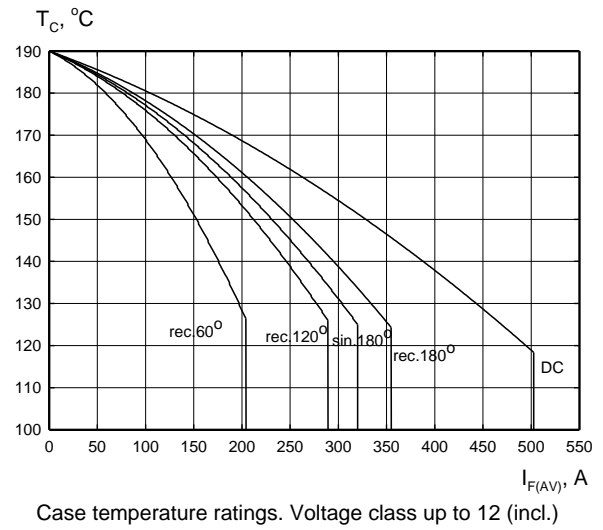
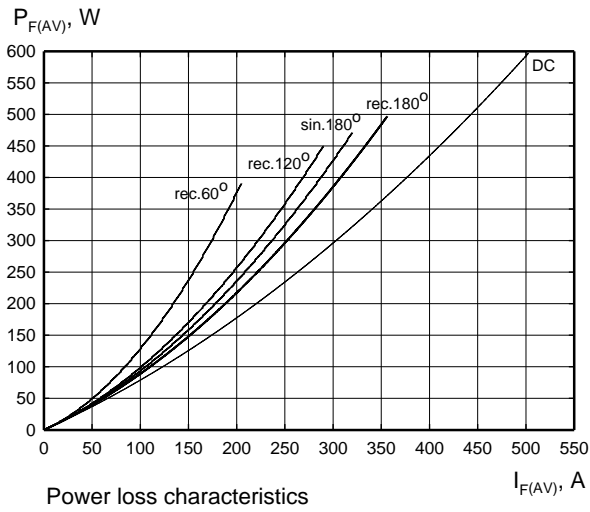

**Zakłady Elektronowe LAMINA S.A.**  
Puławska 34  
PL-05-500 Piaseczno  
POLAND

Tel.: +48-22-7572731  
Tel.: +48-22-3989409  
Fax: +48-22-3989407  
e-mail: sekretariat@lamina.com.pl  
www.lamina.com.pl

# D66-320

## Diode

KKD66320, October 2006 version

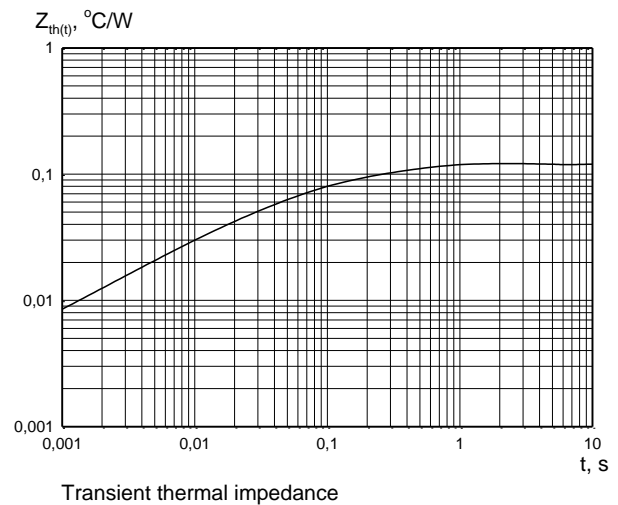
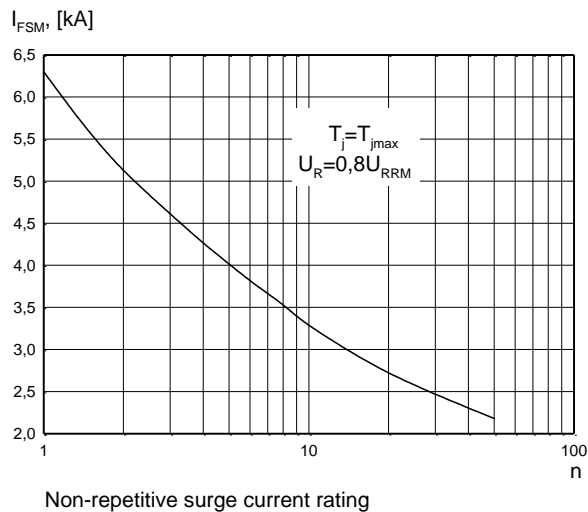

## HEATSINKS

LAMINA S.I. has its own proprietary range of extruded aluminium heatsinks designed to optimise the performance of our semiconductors with natural and forced air flow.

## POWER ASSEMBLY CAPABILITY

LAMINA S.I. provides a support for those customers requiring more than a basic semiconductor and offers precisely assembled Power Blocks according to factory or customer standards.

Zakłady Elektronowe LAMINA S.A.  
Puławska 34  
PL-05-500 Piaseczno  
POLAND

Tel.: +48-22-7572731  
Tel.: +48-22-3989409  
Fax.: +48-22-3989407  
e-mail: sekretariat@lamina.com.pl  
www.lamina.com.pl

## X-ON Electronics

Largest Supplier of Electrical and Electronic Components

*Click to view similar products for [Rectifiers](#) category:*

*Click to view products by [KUBARA LAMINA](#) manufacturer:*

Other Similar products are found below :

[70HFR40](#) [RL252-TP](#) [1N5397](#) [NTE5841](#) [SCF5000](#) [1N4002G](#) [1N4005-TR](#) [JANS1N6640US](#) [481235F](#) [RRE02VS6SGTR](#) [067907F](#) [MS306](#)  
[70HF40](#) [T110HF60](#) [T85HFL60S02](#) [US2JFL-TP](#) [A1N5404G-G](#) [CRS04\(T5L,TEMQ\)](#) [ACGRA4007-HF](#) [ACGRB207-HF](#) [CLH03\(TE16L,Q\)](#)  
[ACGRC307-HF](#) [ACEFC304-HF](#) [NTE6356](#) [NTE6359](#) [85HFR60](#) [40HFR60](#) [1N1186RA](#) [70HF120](#) [85HFR80](#) [D126A45C](#) [SCF7500](#)  
[D251N08B](#) [SCHJ22.5K](#) [SM100](#) [SCPA2](#) [SDHD5K](#) [VS-12FL100S10](#) [ACGRA4001-HF](#) [D1821SH45T PR](#) [D1251S45T](#) [NTE6358](#) [NTE6162](#)  
[NTE5850](#) [SKN 5/08](#) [NTE5819](#) [NTE5837](#) [NTE5892](#) [NTE5894](#) [NTE5900](#)