

Dual SCR Power Modules are designed for use in power electronic circuits and equipment under normal operating conditions.

KEY PARAMETERS

U_{DRM}, U_{RRM}	up to 1600 V
$I_{T(AV)}$	106 A
I_{TSM}	2500 A
du/dt^*	500 V/ μ s
di/dt	100 A/ μ s

* maximum (non standard) value

Outline

See package details for further information

APPLICATION

- High Voltage Power Supplies
- Motor Control

FEATURES

- electrically isolated base
- high current capabilities
- high surge current capabilities
- high rates voltages
- low thermal impedance (Aluminium Nitride Insulators)
- tested according to IEC standards
- compact size and small weight

Designed for use in high power industrial and commercial power electronic circuits and equipment where high currents are encountered and high reliability is essential.

ORDERING INFORMATION

When ordering please refer to device code builder presented below.

Please use the complete part number when ordering, quote or in any future correspondence relating to your order.

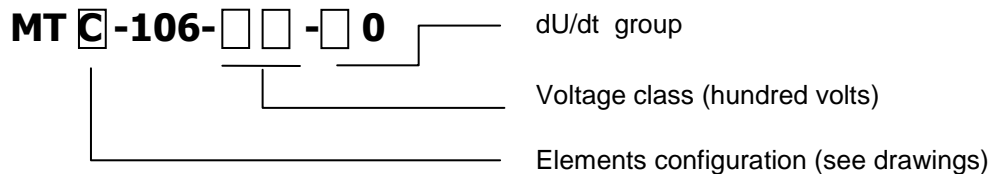

ELECTRICAL PARAMETERS**Voltage ratings**

Voltage class	U_{RRM}	U_{RSM}	I_{RRM}
	V	V	mA
04	400	500	20
06	600	700	
08	800	900	
10	1000	1100	
12	1200	1300	
14	1400	1500	
16	1600	1700	

dU/dt group codes

Group code	du/dt
	V/ μ s
0	no specified value
5	320
6	500

Electrical properties

Parameter		Unit	Test conditions	Value
Average on-state current	$I_{T(AV)}$	A		106
Case temperature	T_C	°C		85
RMS on-state current	$I_{T(RMS)}$	A		166
Surge current	I_{TSM}	A	$T_j=125^\circ\text{C}$, $U_R=0,8U_{RRM}$, $t_p=10\text{ms}$	2250
I^2t – value	I^2t	kA^2s		25
On-state voltage max.	U_{TM}	V	$T_j=25^\circ\text{C}$, $I_{TM}=300\text{A}$	1,65
Threshold voltage	$U_{T(TO)}$	V		0,9
Slope resistance	r_T	$\text{m}\Omega$		2,0
Latching current	I_L	mA	$T_j=25^\circ\text{C}$, $U_D=12\text{V}$	600
Holding current	I_H	mA	$T_j=25^\circ\text{C}$, $U_D=12\text{V}$	250
Circuit commutated turn-off time (typical)	t_q	μs	$T_j=125^\circ\text{C}$, $I_{TM}=150\text{A}$, $di_R/dt=12,5\text{A}/\mu\text{s}$, $du/dt=20\text{V}/\mu\text{s}$, $U_D=0,67U_{DRM}$, $U_{RM}=100\text{V}$	100
Turn-On time (typical)	t_{gt}	μs	$I_{TM}=100\text{A}$, $U_{DM}=100\text{V}$	10
Rate of rise of on-state current-repetitive	di/dt	$\text{A}/\mu\text{s}$	$T_j=125^\circ\text{C}$, $I_{TM}=3I_{T(AV)}$, $U_D=0,67U_{DRM}$, $f=50\text{Hz}$, $I_{GM}=1\text{A}$, $di_G/dt=1\text{A}/\mu\text{s}$	100
Critical rate of raise of off-state voltage	du/dt	$\text{V}/\mu\text{s}$	$T_j=125^\circ\text{C}$, $U_D=0,67U_{DRM}$,	320
Gate current to trigger	I_{GT}	mA	$T_j=25^\circ\text{C}$, $U_D=12\text{V}$	100
Gate voltage to trigger	U_{GT}	V	$T_j=25^\circ\text{C}$, $U_D=12\text{V}$	3
RMS isolation voltage	U_{isol}	V	1s, circuit to base, all terminals shorted	3000

Thermal properties

Parameter		Unit	Test conditions	Value
Thermal resistance, junction to case per thyristor/module	R_{thJC}	°C/W	DC	0,28/0,14
Thermal resistance, case to heatsink per thyristor/module	R_{thCh}	°C/W		0,20/0,10
Operating junction temperature	$T_{jmin} \dots T_{jmax}$	°C		-40...+125
Storage temperature	T_{stg}	°C		-40...+125

Mechanical properties

Parameter		Unit	Value
Mounting torque	M1	Nm	5,00 ±15%
Terminal connection torque (M5)	M2	Nm	3,00 ±15%
Weight	M	g	95

Cofigurations

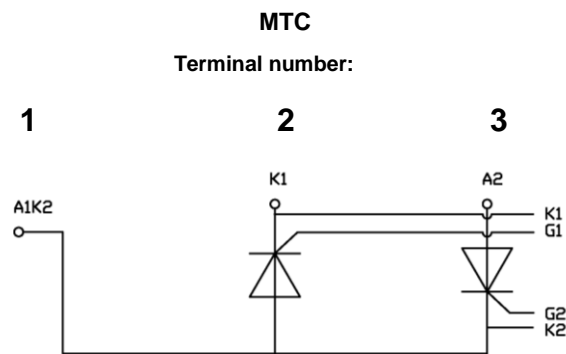

Package details

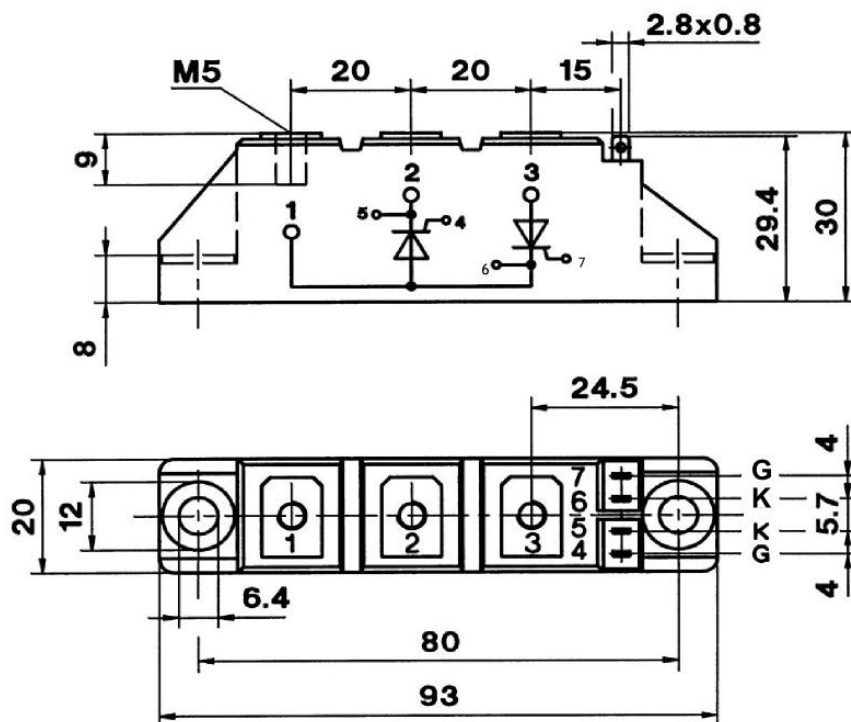

For further package information, please contact Sales & Marketing Department. All dimensions in mm, unless stated otherwise.
Do not scale.

CHARACTERISTICS

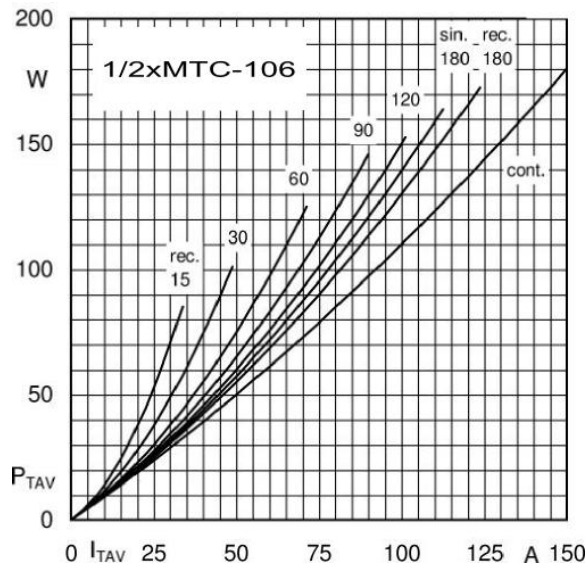

Power loss characteristics

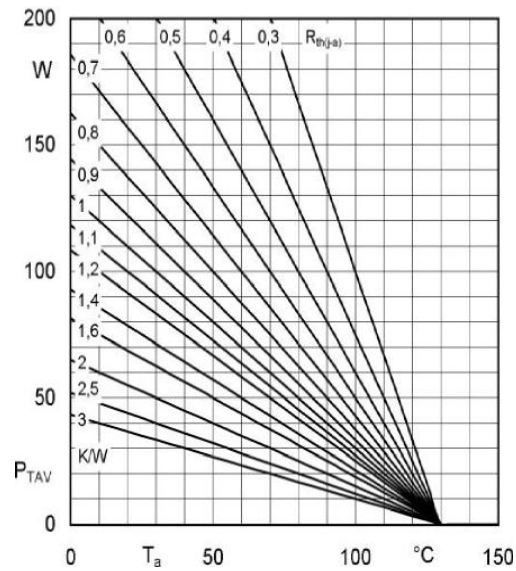

Power loss per diode vs ambient temperature

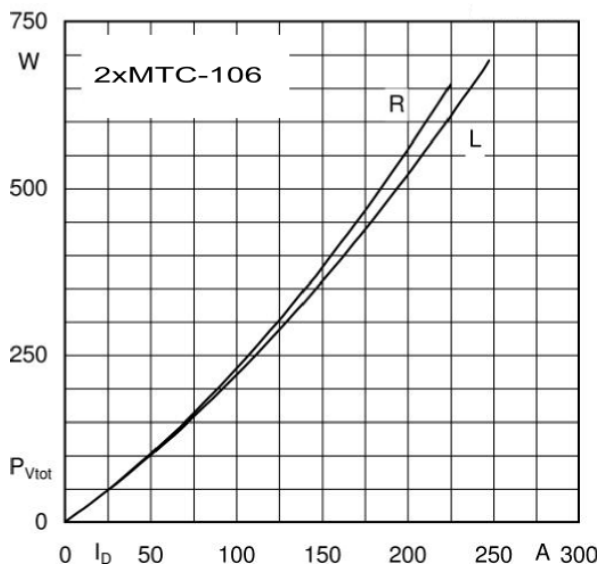

Power loss characteristics of two modules

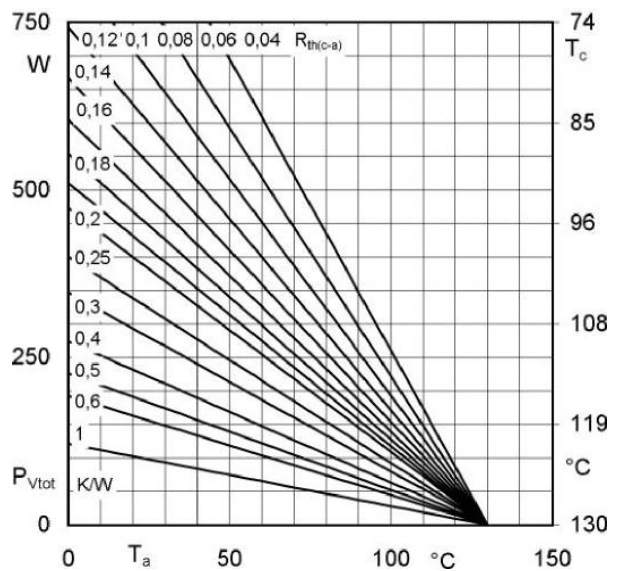

Power loss of two module vs case temperature

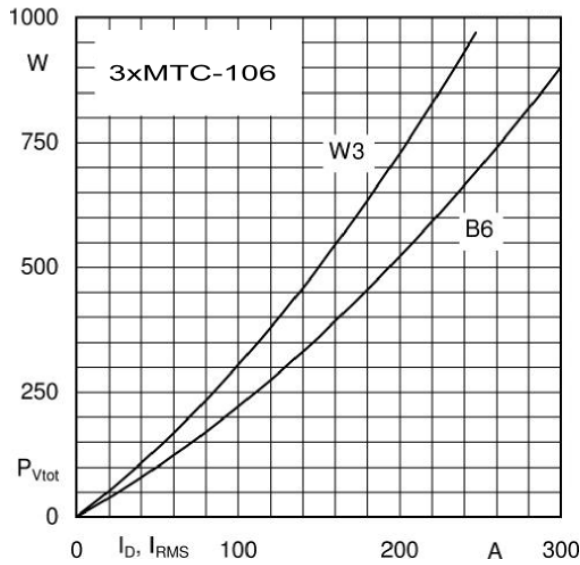

Power loss characteristics of three module

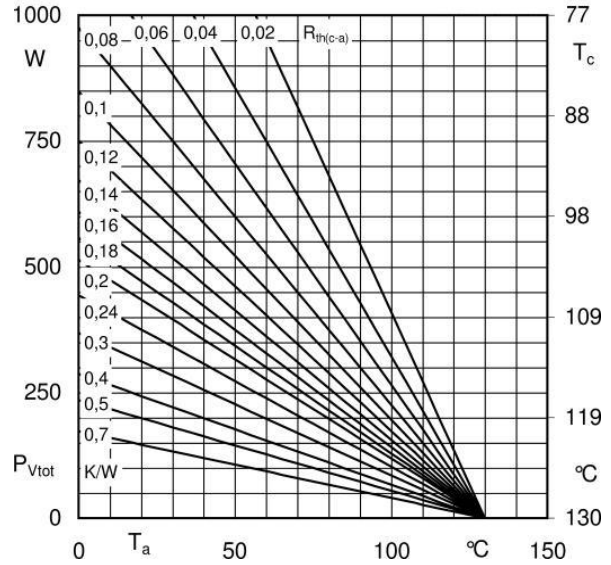

Power loss of three modules vs case temperature

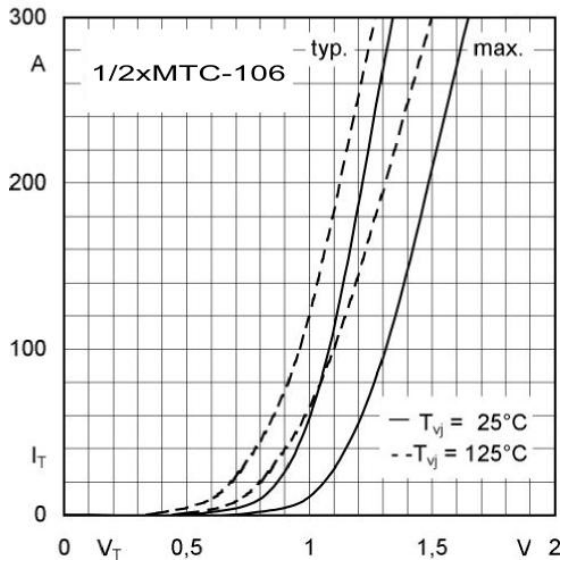

Forward characteristic

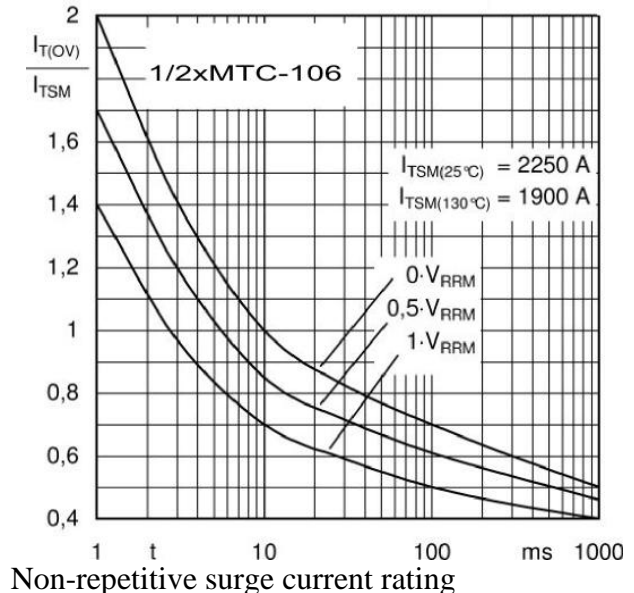

Non-repetitive surge current rating

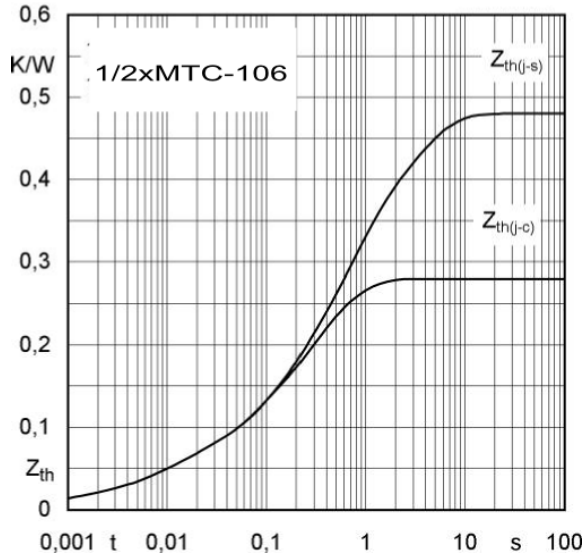

Transient thermal impedance

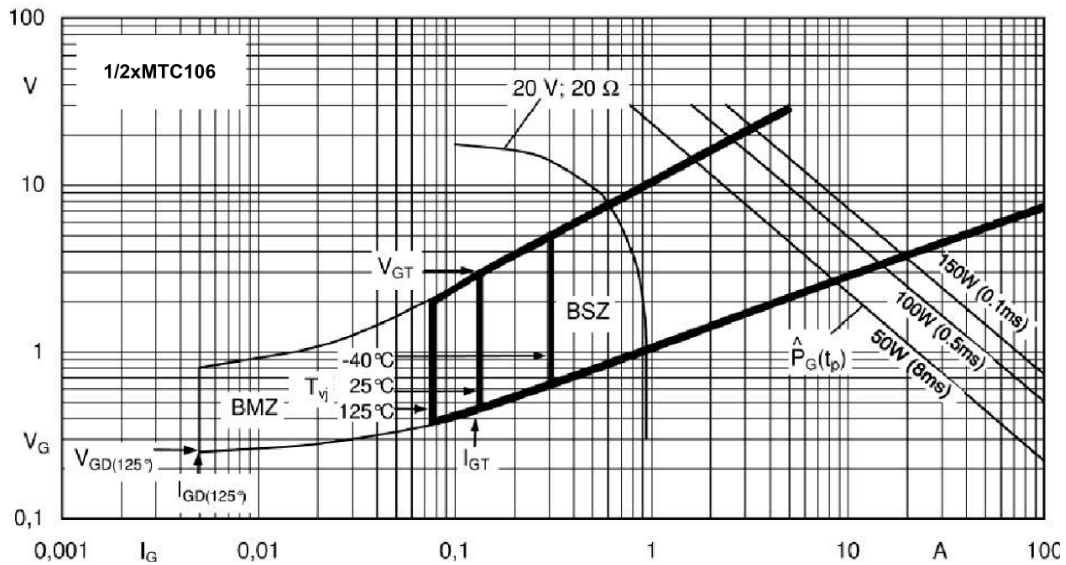

Gate trigger characteristic

X-ON Electronics

Largest Supplier of Electrical and Electronic Components

Click to view similar products for [SCR Modules](#) category:

Click to view products by [KUBARA LAMINA](#) manufacturer:

Other Similar products are found below :

[DT430N22KOF](#) [T1401N42TOH](#) [T1851N60TOH](#) [T420N12TOF](#) [T470N16TOF](#) [T640N16TOF](#) [T901N36TOF](#) [TD140N18KOF](#)
[TD142N16KOF](#) [TD162N16KOF-A](#) [TD330N16AOF](#) [TT215N22KOF](#) [TZ310N20KOF](#) [TZ425N12KOF](#) [TZ500N12KOF](#) [T300N14TOF](#)
[T3710N06TOF](#) [VT](#) [T390N16TOF](#) [T420N16TOF](#) [T460N24TOF](#) [T501N70TOH](#) [T560N16TOF](#) [T590N16TOF](#) [T640N14TOF](#) [TT600N16KOF](#)
[TZ240N36KOF](#) [TT210N12KOF](#) [NTE5710](#) [TT240N28KOF](#) [TZ425N14KOF](#) [T1081N60TOH](#) [TT61N08KOF](#) [TD251N18KOF](#)
[TZ240N34KOF](#) [TT162N08KOF](#) [TD285N16KOF](#) [TZ430N22KOF](#) [TT180N12KOF](#) [T2001N34TOF](#) [TT122N22KOF](#) [TD140N22KOF](#)
[MDMA200P1600SA](#) [TT180N16KOF](#) [VS-ST333C08LFM0](#) [VS-ST180C14C0L](#) [T1080N02TOF](#) [TD320N16SOF](#) [T360N22TOF](#)
[TZ810N22KOF](#) [T2563NH80TOH](#)