

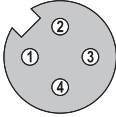







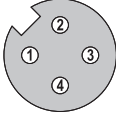

Connection technology



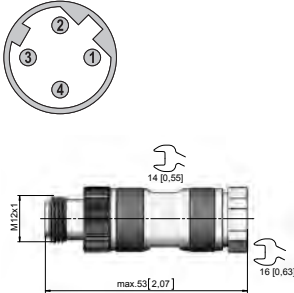







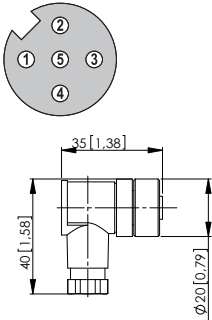

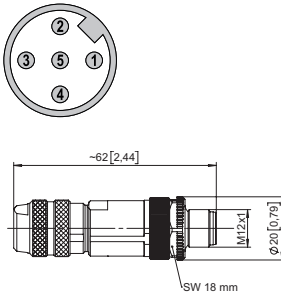
M12 connection technology		Connectors, self-assembly		Order no.
4 pin				
<p>Female connector with coupling nut A coded, straight power supply</p> <p>Housing: plastic, IP67</p> 	<p>screw connections, for cable \varnothing 4 ... 6 mm [0.16 ... 0.24"]</p> 	<p>suitable for our series:</p> <p>5858 / 5878 5868 / 5888 F5858 / F5878 F5868 / F5888</p> <p>C60, D120</p> <p>EMIO.SIO.10xP</p>	<p>05.B8141-0</p>	
<p>Female connector with coupling nut A coded, right-angle power supply</p> <p>Housing: plastic, IP67</p> 	<p>screw connections, for cable \varnothing 4 ... 6 mm [0.16 ... 0.24"]</p> 	<p>suitable for our series:</p> <p>5858 / 5878 5868 / 5888</p> <p>C60, D120</p> <p>EMIO.SIO.10xP</p>	<p>05.B8241-0</p>	
<p>Male connector with external thread A coded, straight power supply</p> <p>Housing: metal / plastic, IP67</p> 	<p>screw connections, for cable \varnothing 4 ... 6 mm [0.16 ... 0.24"]</p> 	<p>suitable for:</p> <p>versions with cable outlet</p>	<p>05.BS8141-0</p>	
<p>Male connector with external thread D coded, straight</p> <p>Housing: metal, IP67</p> 	<p>displacement/terminal connection, for cable \varnothing 4 ... 9 mm [0.16 ... 0.35"]</p> 	<p>suitable for our series:</p> <p>5858 / 5878 5868 / 5888 F5858 / F5878 F5868 / F5888</p> <p>SR120, SR160, SR250H</p> <p>EtherCAT Conformance tested</p> <p>PROFINET</p> <p>EtherNet/IP</p>	<p>05.WASCSY4S</p>	

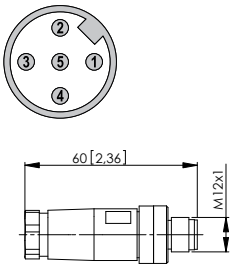
Connection technology

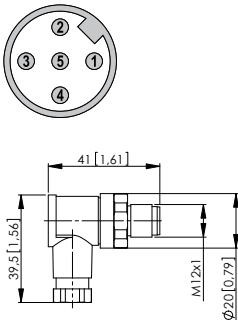

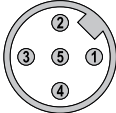
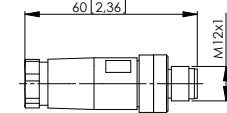

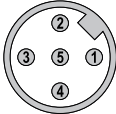
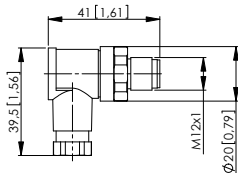

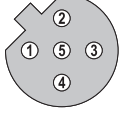
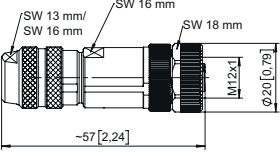

M12 connection technology Connectors, self-assembly

5 pin		Order no.															
<p>Female connector with coupling nut A coded, straight</p> <p>Housing: metal, IP67</p> 	<p>screw connections, for cable $\varnothing 6 \dots 8 \text{ mm}$ [0.24 ... 0.32"]</p>	<p>suitable for our series:</p> <table border="0"> <tr> <td>3651 / 3671</td> <td>M3658 / M3678</td> </tr> <tr> <td>F3658 / F3658</td> <td>5858 / 5878</td> </tr> <tr> <td>M3661 / M3681</td> <td>M3661R</td> </tr> <tr> <td>M3668 / M3688</td> <td>M3668R</td> </tr> <tr> <td>F3668 / F3688</td> <td>F5868 / F5888</td> </tr> <tr> <td>M5861</td> <td>M5868</td> </tr> <tr> <td>5868 / 5888</td> <td>F5888M</td> </tr> </table> <p>A50, B80, C60, C100, C120, D120, D125, D135</p> <p>IS40, IS60, IN88</p> <p>SR120, SR160, SR250H</p> <p>CANopen DeviceNet</p>	3651 / 3671	M3658 / M3678	F3658 / F3658	5858 / 5878	M3661 / M3681	M3661R	M3668 / M3688	M3668R	F3668 / F3688	F5868 / F5888	M5861	M5868	5868 / 5888	F5888M	<p>8.0000.5116.0000</p>
3651 / 3671	M3658 / M3678																
F3658 / F3658	5858 / 5878																
M3661 / M3681	M3661R																
M3668 / M3688	M3668R																
F3668 / F3688	F5868 / F5888																
M5861	M5868																
5868 / 5888	F5888M																
<p>Female connector with coupling nut A coded, straight</p> <p>Housing: stainless steel V4A, IP67</p> 	<p>screw connections, for cable $\varnothing 6 \dots 8 \text{ mm}$ [0.24 ... 0.32"]</p>	<p>suitable for our series:</p> <p>M3668R M3661R</p> <p>CANopen DeviceNet</p>	<p>8.0000.5116.0000.V4A</p>														
<p>Female connector with coupling nut A coded, straight</p> <p>Housing: metal, IP67</p> 	<p>screw connections, for cable $\varnothing 6 \dots 9 \text{ mm}$ [0.24 ... 0.35"]</p>	<p>suitable for our series:</p> <p>ATEX zone 2/22 encoders</p> <p>Ex 2/22</p> <p>CANopen DeviceNet</p>	<p>8.0000.5116.0000.Ex</p>														
<p>Female connector with coupling nut A coded, straight</p> <p>Housing: plastic, IP67</p> 	<p>screw connections, for cable $\varnothing 4 \dots 8 \text{ mm}$ [0.16 ... 0.32"]</p>	<p>suitable for our series:</p> <p>3651 / 3671</p> <p>A50, B80, C60, C100, C120, D120, D125, D135</p> <p>IS40, IS60, IN88</p> <p>CANopen DeviceNet</p>	<p>05.B-8151-0/9</p>														

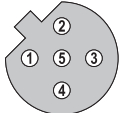
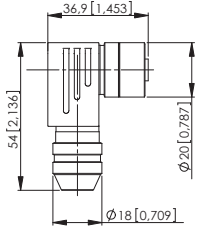
Connection technology

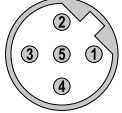
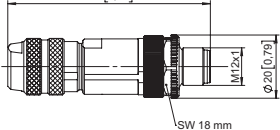
M12 connection technology		Connectors, self-assembly		Order no.
5 pin				
Female connector with coupling nut A coded, right-angle Housing: plastic, IP67 	screw connections, for cable \varnothing 6 ... 8 mm [0.24 ... 0.32"]  	suitable for our series: 3651 / 3671 A50, B80, C60, C100, C120, D120, D125, D135 IS40, IS60, IN88 	05.B-8251-0/9	
Male connector with external thread A coded, straight Housing: metal, IP67 	screw connections, for cable \varnothing 6 ... 8 mm [0.24 ... 0.32"]  	suitable for our series: F3658 / F3658 F3668 / F3688 M3658 / M3678 M3668 / M3688 M3668R / M3688R 5858 / 5878 5868 / 5888 F5868 / F5888 F5888M IS60, IN88 SR120, SR160, SR250H 		
Male connector with external thread A coded, straight Housing: metal / plastic, IP67 	screw connections, for cable \varnothing 6 ... 8 mm [0.24 ... 0.32"]  	suitable for our series: F3658 / F3658 F3668 / F3688 M3658 / M3678 M3668 / M3688 5858 / 5878 5868 / 5888 F5868 / F5888 IS60, IN88 EMIO.SIO.10xP 	05.BS-8151-0/9	
Male connector with external thread A coded, right-angle Housing: metal / plastic, IP67 	screw connections, for cable \varnothing 6 ... 8 mm [0.24 ... 0.32"]  	suitable for our series: F3658 / F3658 F3668 / F3688 M3658 / M3678 M3668 / M3688 5858 / 5878 5868 / 5888 F5868 / F5888 IS60, IN88 		

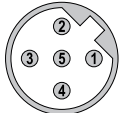
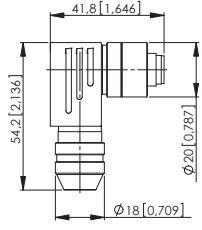
Connection technology

M12 connection technology		Connectors, self-assembly		Order no.
5 pin				
Female connector with coupling nut B coded, straight Housing: metal, IP67 	screw connections, for cable \varnothing 4 ... 9 mm [0.16 ... 0.35"]  	suitable for our series: 5858 / 5878 5868 / 5888 SR120, SR160, SR250H 	05.BMWS 8151-8.5	
Female connector with coupling nut B coded, right-angle Housing: metal, IP67 	screw connections, for cable \varnothing 4 ... 9 mm [0.16 ... 0.35"]  	suitable for our series: 5858 / 5878 5868 / 5888 SR120, SR160, SR250H 	05.BMWS 8251-8.5	
Male connector with external thread B coded, straight Housing: metal, IP67 	screw connections, for cable \varnothing 4 ... 9 mm [0.16 ... 0.35"]  	suitable for our series: 5858 / 5878 5868 / 5888 SR120, SR160, SR250H 	05.BMSWS 8151-8.5	
Male connector with external thread B coded, right-angle Housing: metal, IP67 	screw connections, for cable \varnothing 4 ... 9 mm [0.16 ... 0.35"]  	suitable for our series: 5858 / 5878 5868 / 5888 SR120, SR160, SR250H 	05.BMSWS 8251-8.5	

M12 connection technology Connectors, self-assembly

5 pin Order no.

**Male connector with external thread
D coded, straight**

Housing: metal, IP67



screw connections,
for cable \varnothing 6 ... 8 mm [0.24 ... 0.32"]

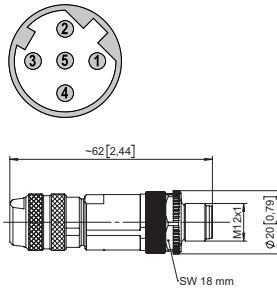

suitable for our series:

5858 / 5878	5868 / 5888
F5858 / F5878	F5868 / F5888

8.0000.5121.0000.Ex









EtherCAT
Conformance tested

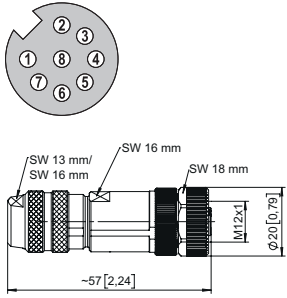

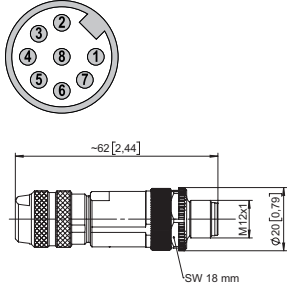
EtherNet/IP

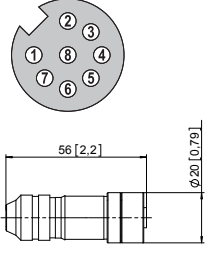
Connection technology

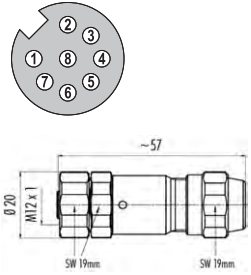



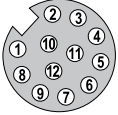
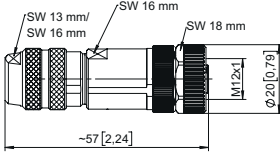

M12 connection technology		Connectors, self-assembly		Order no.
8 pin				
Female connector with coupling nut A coded, straight Housing: metal, IP67 	screw connections, for cable \varnothing 6 ... 8 mm [0.24 ... 0.32"] 	suitable for our series: 3610 / 3620 KIS40 / KIH40 F3653 / F3673 F3663 / F3683 M3663 / M3683 M3663R 5000 / 5020 5006 / 5026 KIS50 / KIH50 5814 / 5834 58x4FSx 5853 / 5873 5863 / 5883 M5863 5821 F5883M H120 A020 / A02H C60, D120, D125	05.CMB 8181-0	
Male connector with external thread A coded, straight Housing: metal, IP67 	screw connections, for cable \varnothing 6 ... 8 mm [0.24 ... 0.32"] 	suitable for: versions with cable outlet	05.CMBS 8181-0	
Female connector with coupling nut A coded, straight Housing: metal, IP67 	screw connections, for cable \varnothing 6 ... 9 mm [0.24 ... 0.35"] 	suitable for our series: ATEX zone 2/22 encoders 	8.0000.5136.0000.Ex	
Female connector with coupling nut A coded, straight Housing: stainless steel V4A, IP67 	screw connections, for cable \varnothing 6 ... 9 mm [0.24 ... 0.35"] 	suitable for our series: M3663R 5006 / 5026 A02H	8.0000.5136.0000.V4A	

Connection technology

M12 connection technology Connectors, self-assembly

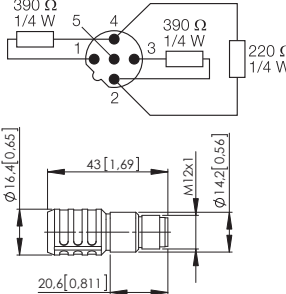
12 pin		Order no.
<p>Female connector with coupling nut A coded, straight Housing: metal, IP67</p> 	<p>screw connections, for cable \varnothing 6 ... 8 mm [0.24 ... 0.32"]</p>  	<p>suitable for: LA10</p> <p>8.0000.5162.0000</p>

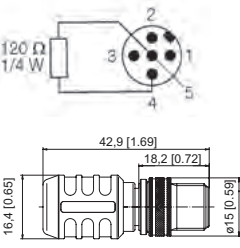
Connection technology

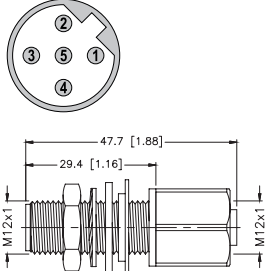
M12 connection technology		Connectors, self-assembly		Order no.
Accessories				
Securing clip for M12 connectors Material: plastic 	against accidental disconnection under load working temperature range -25°C ... +90°C [-13°F ... +194°F]	suitable for: M12 connectors	8.0000.5000.0006	
Terminating resistor Male connector with external thread B coded, straight Housing: metal / plastic, IP67 		suitable for our series: 5858 / 5878 5868 / 5888	05.RSS4.5-PDP-TR	
Terminating resistor Male connector with external thread A coded, straight Housing: metal / plastic, IP67 		suitable for our series: 5858 / 5878 5868 / 5888 F5868 / F5888 F5888M IN88	05.RSE 57 TR2	
M12 lead-through B coded, straight Housing: metal, IP67 		suitable for our series: 5858 / 5878 5868 / 5888	05.FKW-FSW45/M12	

Connection technology



M12 connection technology Connectors, self-assembly

Accessories		Order no.
<p>T-junction A coded, 5 pin Housing: metal / plastic, IP67</p>	<p>2 x female connector with coupling nut 1 x male connector with external thread</p>	<p>suitable for: M12 connectors</p> <p>DeviceNet</p> <p>05.FKM5-FKM5-FSM5</p>
<p>T-junction, shielded A coded, 5 pin Housing: metal / plastic, IP67</p>	<p>2 x female connector with coupling nut 1 x male connector with external thread</p>	<p>suitable for: M12 connectors</p> <p>CANopen</p> <p>05.WAKS5-WAKS5-WASS5</p>

Connection technology

M12 connection technology

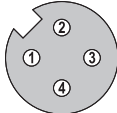
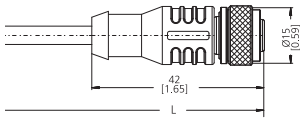
Cordsets, pre-assembled

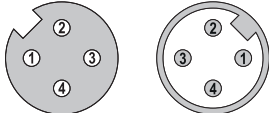
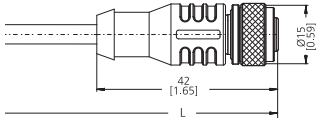
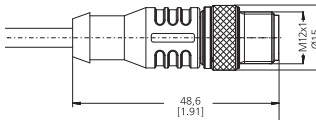
With connector, 4 pin		Working temp. -30°C ... +80°C [-22°F ... +176°F]	Order no.										
<p>Female connector with coupling nut + single-ended A coded, straight power supply</p> <p>Cable: PUR, 4 x 0.34 mm² [AWG22] Housing: metal / plastic, IP67</p>    <p><i>Terminal assignment</i></p> <table border="1"> <tr> <td>Pin female contacts:</td> <td>1</td> <td>2</td> <td>3</td> <td>4</td> </tr> <tr> <td>Core color:</td> <td>BN</td> <td>WH</td> <td>BU</td> <td>BK</td> </tr> </table>		Pin female contacts:	1	2	3	4	Core color:	BN	WH	BU	BK	<p>suitable for our series:</p> <p>5858 / 5878 5868 / 5888 F5858 / F5878 F5868 / F5888 H120 EMIO.SIO.10xP</p> <p><i>cable length ¹⁾</i></p> <p>standard cable length 2 m [6.56'] (available from 1 piece) 5 m [16.40'] 10 m [32.81'] 15 m [49.21']</p> <p>other cable lengths (minimum order quantity 4 pieces)</p>	<p>05.00.6061.6211.002M 05.00.6061.6211.005M 05.00.6061.6211.010M 05.00.6061.6211.015M</p> <p>05.00.6061.6211.0xxM xx = length in meters: 1, 3, 8, 12, 20, 25, 30</p>
Pin female contacts:	1	2	3	4									
Core color:	BN	WH	BU	BK									
<p>Female connector with coupling nut + male connector with external thread A coded, straight power supply</p> <p>Cable: PUR, 4 x 0.34 mm² [AWG22] Housing: metal / plastic, IP67</p>    		<p>suitable for our series:</p> <p>5858 / 5878 5868 / 5888 EMIO.SIO.10xP</p> <p><i>cable length ¹⁾</i></p> <p>standard cable length 2 m [6.56'] (available from 1 piece) 5 m [16.40'] 10 m [32.81'] 15 m [49.21']</p> <p>other cable lengths (minimum order quantity 4 pieces)</p>	<p>05.00.6061.6462.002M 05.00.6061.6462.005M 05.00.6061.6462.010M 05.00.6061.6462.015M</p> <p>05.00.6061.6462.0xxM xx = length in meters: 1, 3, 8, 12, 20, 25, 30</p>										

1) Other cable lengths on request.

Connection technology

M12 connection technology

Cordsets, pre-assembled

With connector, 5 pin

Working temp. -30°C ... +80°C [-22°F ... +176°F]

Order no.

Female connector with coupling nut + single-ended A coded, straight

Cable: PUR, 4 x 0.34 mm² [AWG22]
Housing: metal / plastic, IP67



Bus-in

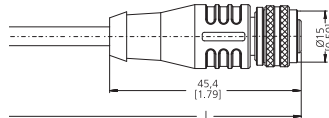
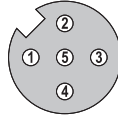

suitable for our series:

IS60, IN88
SR160, SR250H

DeviceNet

*cable length*¹⁾

standard cable length 2 m [6.56']
(available from 1 piece) 5 m [16.40']
10 m [32.81']
15 m [49.21']

other cable lengths
(minimum order quantity 4 pieces)

05.00.6021.2211.002M
05.00.6021.2211.005M
05.00.6021.2211.010M
05.00.6021.2211.015M

05.00.6021.2211.0xxM

xx = length in meters:
1, 3, 8, 12, 20, 25, 30

Terminal assignment

Pin female contacts:	1	2	3	4	5
Core color:	± 3)	RD	BK	WH	BU

Female connector with coupling nut + single-ended A coded, straight

Cable: PVC,
3 x 2 x 0.25 mm² [AWG23]
Housing: metal / plastic, IP67



Bus-in

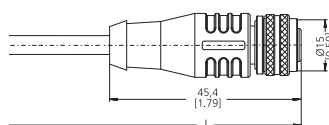
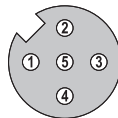

suitable for our series:

M3658 / M3678 M3668 / M3688
M3668R
5858 / 5878 5868 / 5888
M5868 F5868 / F5888

C60, C100, D120, D125

IN88
SR160, SR250H

CANopen

*cable length*¹⁾

standard cable length 2 m [6.56']
(available from 1 piece) 5 m [16.40']
10 m [32.81']
15 m [49.21']

other cable lengths
(minimum order quantity 4 pieces)

05.00.6091.A211.002M
05.00.6091.A211.005M
05.00.6091.A211.010M
05.00.6091.A211.015M

05.00.6091.A211.0xxM

xx = length in meters:
1, 3, 8, 12, 20, 25, 30

Terminal assignment

Pin female contacts:	1	2	3	4	5	PH ²⁾
Core color:	GY	BN	WH	GN	YE	PH ²⁾

1) Other cable lengths on request.

2) Shield on housing.

3) Shield with pin 1.

Connection technology

M12 connection technology Cordsets, pre-assembled

With connector, 5 pin Working temp. -30°C ... +80°C [-22°F ... +176°F] Order no.

Male connector with external thread + single-ended
A coded, straight

Cable: PUR, 4 x 0.34 mm² [AWG22]
 Housing: metal / plastic, IP67



Bus out

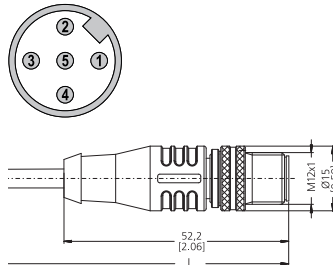

suitable for our series:

IS60, IN88
 SR160, SR250H

DeviceNet

cable length ¹⁾

standard cable length 2 m [6.56']
 (available from 1 piece) 5 m [16.40']
 10 m [32.81']
 15 m [49.21']

05.00.6021.2411.002M
05.00.6021.2411.005M
05.00.6021.2411.010M
05.00.6021.2411.015M

other cable lengths
 (minimum order quantity 4 pieces)

05.00.6021.2411.0xxM
 xx = length in meters:
 1, 3, 8, 12, 20, 25, 30

Terminal assignment

Pin male contacts:	1	2	3	4	5
Core color:	± 3)	RD	BK	WH	BU

Male connector with external thread + single-ended
A coded, straight

Cable: PVC, 3 x 2 x 0.25 mm² [AWG23]
 Housing: metal / plastic, IP67



Bus out

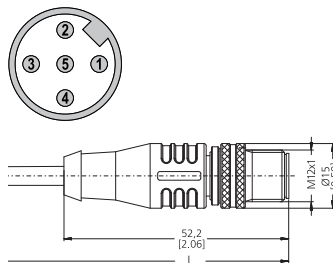

suitable for our series:

M3658 / M3678 F5868 / F5888
 5858 / 5878 5868 / 5888

C60
 IN88
 SR160, SR250H
 EMIO.SIO.10xP

CANopen

cable length ¹⁾

standard cable length 2 m [6.56']
 (available from 1 piece) 5 m [16.40']
 10 m [32.81']
 15 m [49.21']

05.00.6091.A411.002M
05.00.6091.A411.005M
05.00.6091.A411.010M
05.00.6091.A411.015M

other cable lengths
 (minimum order quantity 4 pieces)

05.00.6091.A411.0xxM
 xx = length in meters:
 1, 3, 8, 12, 20, 25, 30

Terminal assignment



Pin male contacts:	1	2	3	4	5	PH ²⁾
Core color:	GY	BN	WH	GN	YE	PH ²⁾

1) Other cable lengths on request.
 2) Shield on housing.
 3) Shield with pin 1.

Connection technology

M12 connection technology

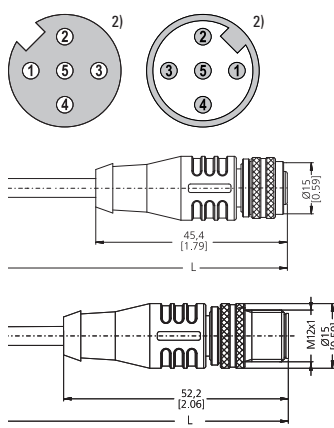
Cordsets, pre-assembled

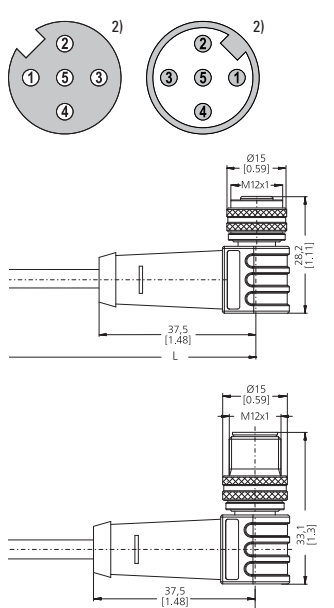
With connector, 5 pin		Working temp. -30°C ... +80°C [-22°F ... +176°F]	Order no.
<p>Female connector with coupling nut + male connector with external thread A coded, straight</p> <p>Cable: PUR, 2 x 0,25 mm² [AWG23] + 2 x 0,34 mm² [AWG22] Housing: metal / plastic, IP67</p> 	<p>Bus in / out</p> 	<p>suitable for our series:</p> <p>M3658 / M3678 F5868 / F5888 5858 / 5878 5868 / 5888</p> <p>C60, C100, D120, D125</p> <p>IS60, IN88</p> <p>SR160, SR250H</p> <p>EMIO.SIO.10xP</p> <p>CANopen DeviceNet</p> <p><i>cable length ¹⁾</i></p> <p>standard cable length 2 m [6.56'] (available from 1 piece) 5 m [16.40'] 10 m [32.81'] 15 m [49.21']</p> <p>other cable lengths (minimum order quantity 4 pieces)</p>	<p>05.00.6021.2422.002M 05.00.6021.2422.005M 05.00.6021.2422.010M 05.00.6021.2422.015M</p> <p>05.00.6021.2422.0xxM xx = length in meters: 1, 3, 8, 12, 20, 25, 30</p>
<p>Female connector with coupling nut + male connector with external thread A coded, right-angle</p> <p>Cable: PUR, 2 x 0,25 mm² [AWG23] + 2 x 0,34 mm² [AWG22] Housing: metal / plastic, IP67</p> 	<p>Bus in / out</p> 	<p>suitable for our series:</p> <p>M3658 / M3678 F5868 / F5888 5858 / 5878 5868 / 5888</p> <p>C60, C100, D120, D125</p> <p>IS60, IN88</p> <p>SR160, SR250H</p> <p>EMIO.SIO.10xP</p> <p>CANopen DeviceNet</p> <p><i>cable length ¹⁾</i></p> <p>standard cable length 2 m [6.56'] (available from 1 piece) 5 m [16.40'] 10 m [32.81'] 15 m [49.21']</p> <p>other cable lengths (minimum order quantity 4 pieces)</p>	<p>05.00.6021.2523.002M 05.00.6021.2523.005M 05.00.6021.2523.010M 05.00.6021.2523.015M</p> <p>05.00.6021.2523.0xxM xx = length in meters: 1, 3, 8, 12, 20, 25, 30</p>

1) Other cable lengths on request.
2) Shield on housing.

Connection technology

M12 connection technology Cordsets, pre-assembled

With connector, 5 pin Working temp. -30°C ... +80°C [-22°F ... +176°F] Order no.

Female connector with coupling nut + single-ended A coded, straight

Cable: PVC, 3 x 2 x 0,25 mm² [AWG23]
Housing: metal, IP67



Bus in

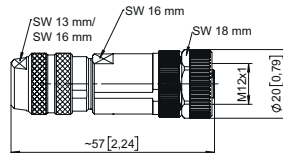
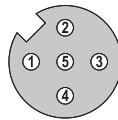

suitable for our series:

M3658 / M3678
5858 / 5878 5868 / 5888
C60, C100, D120, D125
SR160, SR250H



Terminal assignment

Pin female contacts:	1	2	3	4	5	PH 2)
Wire color:	GY	BN	WH	GN	YE	⊥

cable length ¹⁾

standard cable length 2 m [6.56']
(available from 1 piece) 5 m [16.40']
10 m [32.81']
15 m [49.21']

8.0000.6V81.0002
8.0000.6V81.0005
8.0000.6V81.0010
8.0000.6V81.0015

other cable lengths
(minimum order quantity 4 pieces)

8.0000.6V81.00xx
xx = length in meters:
1, 3, 8, 12, 20, 25, 30

Male connector with external thread + single-ended A coded, straight

Cable: PVC, 3 x 2 x 0,25 mm² [AWG23]
Housing: metal, IP67



Bus out

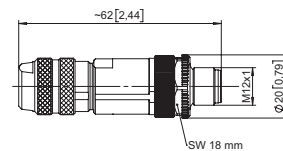
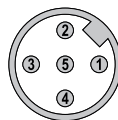

suitable for our series:

M3658 / M3678
5858 / 5878 5868 / 5888
SR160, SR250H



Terminal assignment

Pin male contacts:	1	2	3	4	5	PH 2)
Core color:	GY	BN	WH	GN	YE	⊥

cable length ¹⁾

standard cable length 2 m [6.56']
(available from 1 piece) 5 m [16.40']
10 m [32.81']
15 m [49.21']

8.0000.6V88.0002
8.0000.6V88.0005
8.0000.6V88.0010
8.0000.6V88.0015

other cable lengths
(minimum order quantity 4 pieces)

8.0000.6V88.00xx
xx = length in meters:
1, 3, 8, 12, 20, 25, 30

1) Other cable lengths on request.
2) Shield on housing.

Connection technology

M12 connection technology

Cordsets, pre-assembled

With connector, 5 pin

Working temp. -30°C ... +80°C [-22°F ... +176°F]

Order no.

Female connector with coupling nut + single-ended B coded, straight

Cable: PUR, 2 x 0.34 mm² [AWG22]
Housing: metal / plastic, IP67



Bus-in

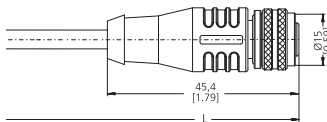
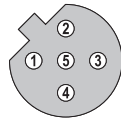

suitable for our series:

5858 / 5878 5868 / 5888
SR120, SR160, SR250H



cable length ¹⁾

standard cable length 2 m [6.56']
(available from 1 piece) 5 m [16.40']
10 m [32.81']
15 m [49.21']

other cable lengths
(minimum order quantity 4 pieces)

05.00.6011.3211.002M
05.00.6011.3211.005M
05.00.6011.3211.010M
05.00.6011.3211.015M

05.00.6011.3211.0xxM

xx = length in meters:
1, 3, 8, 12, 20, 25, 30

Terminal assignment

Pin female contacts:	1	2	3	4	5	PH ²⁾
Core color:	n.c.	GN	n.c.	RD	n.c.	PH ²⁾

Female connector with coupling nut + single-ended B coded, right-angle

Cable: PUR, 2 x 0.34 mm² [AWG22]
Housing: metal / plastic, IP67



Bus-in

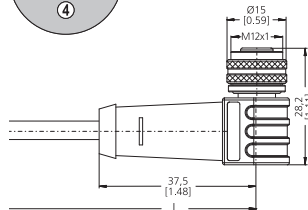
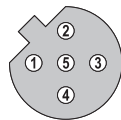

suitable for our series:

5858 / 5878 5868 / 5888
SR120, SR160, SR250H



cable length ¹⁾

standard cable length 2 m [6.56']
(available from 1 piece) 5 m [16.40']
10 m [32.81']
15 m [49.21']

other cable lengths
(minimum order quantity 4 pieces)

05.00.6011.3311.002M
05.00.6011.3311.005M
05.00.6011.3311.010M
05.00.6011.3311.015M

05.00.6011.3311.0xxM

xx = length in meters:
1, 3, 8, 12, 20, 25, 30

Terminal assignment

Pin female contacts:	1	2	3	4	5	PH ²⁾
Core color:	n.c.	GN	n.c.	RD	n.c.	PH ²⁾

1) Other cable lengths on request.
2) Shield on housing.

Connection technology

M12 connection technology Cordsets, pre-assembled

With connector, 5 pin Working temp. -30°C ... +80°C [-22°F ... +176°F] Order no.

Male connector with external thread + single-ended
B coded, straight

Cable: PUR, 2 x 0.34 mm² [AWG22]
 Housing: metal / plastic, IP67



Bus-out

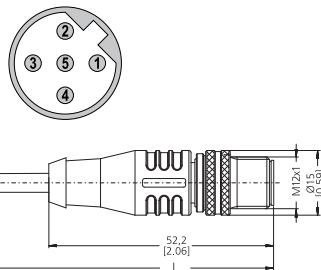

suitable for our series:

5858 / 5878 5868 / 5888
 SR120, SR160, SR250H



Terminal assignment

Pin male contacts:	1	2	3	4	5	PH ²⁾
Core color:	n.c.	GN	n.c.	RD	n.c.	PH ²⁾

cable length¹⁾

standard cable length 2 m [6.56']
 (available from 1 piece) 5 m [16.40']
 10 m [32.81']
 15 m [49.21']

05.00.6011.3411.002M
05.00.6011.3411.005M
05.00.6011.3411.010M
05.00.6011.3411.015M

other cable lengths
 (minimum order quantity 4 pieces)

05.00.6011.3411.0xxM
 xx = length in meters:
 1, 3, 8, 12, 20, 25, 30

Male connector with external thread + single-ended
B coded, right-angle

Cable: PUR, 2 x 0.34 mm² [AWG22]
 Housing: metal / plastic, IP67



Bus-out

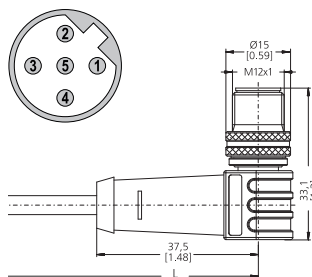

suitable for our series:

5858 / 5878 5868 / 5888
 SR120, SR160, SR250H



Terminal assignment

Pin male contacts:	1	2	3	4	5	PH ²⁾
Core color:	n.c.	GN	n.c.	RD	n.c.	PH ²⁾

cable length¹⁾

standard cable length 2 m [6.56']
 (available from 1 piece) 5 m [16.40']
 10 m [32.81']
 15 m [49.21']

05.00.6011.3511.002M
05.00.6011.3511.005M
05.00.6011.3511.010M
05.00.6011.3511.015M

other cable lengths
 (minimum order quantity 4 pieces)





05.00.6011.3511.0xxM
 xx = length in meters:
 1, 3, 8, 12, 20, 25, 30

1) Other cable lengths on request.
 2) Shield on housing.

Connection technology

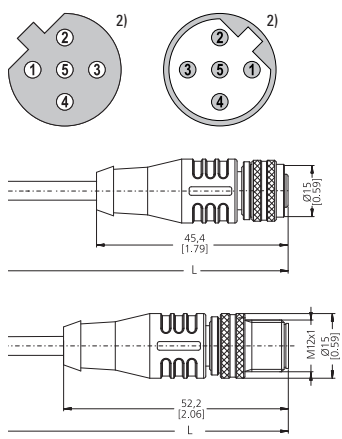
M12 connection technology

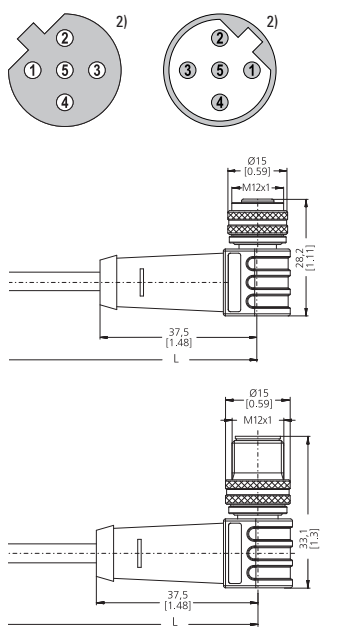
Cordsets, pre-assembled

With connector, 5 pin	Working temp. -30°C ... +80°C [-22°F ... +176°F]	Order no.									
<p>Female connector with coupling nut + male connector with external thread B coded, straight</p> <p>Cable: PUR, 2 x 0.34 mm² [AWG22] Housing: metal / plastic, IP67</p> 	<p>Bus in / out</p> 	<p>suitable for our series:</p> <p>5858 / 5878 5868 / 5888 SR120, SR160, SR250H</p>  <p><i>cable length</i>¹⁾</p> <table border="0"> <tr> <td>standard cable length</td> <td>2 m [6.56']</td> </tr> <tr> <td>(available from 1 piece)</td> <td>5 m [16.40']</td> </tr> <tr> <td></td> <td>10 m [32.81']</td> </tr> <tr> <td></td> <td>15 m [49.21']</td> </tr> </table> <p>other cable lengths (minimum order quantity 4 pieces)</p>	standard cable length	2 m [6.56']	(available from 1 piece)	5 m [16.40']		10 m [32.81']		15 m [49.21']	<p>05.00.6011.3432.002M 05.00.6011.3432.005M 05.00.6011.3432.010M 05.00.6011.3432.015M</p> <p>05.00.6011.3432.0xxM xx = length in meters: 1, 3, 8, 12, 20, 25, 30</p>
standard cable length	2 m [6.56']										
(available from 1 piece)	5 m [16.40']										
	10 m [32.81']										
	15 m [49.21']										
<p>Female connector with coupling nut + male connector with external thread B coded, right-angle</p> <p>Cable: PUR, 2 x 0.34 mm² [AWG22] Housing: metal / plastic, IP67</p> 	<p>Bus in / out</p> 	<p>suitable for our series:</p> <p>5858 / 5878 5868 / 5888 SR120, SR160, SR250H</p>  <p><i>cable length</i>¹⁾</p> <table border="0"> <tr> <td>standard cable length</td> <td>2 m [6.56']</td> </tr> <tr> <td>(available from 1 piece)</td> <td>5 m [16.40']</td> </tr> <tr> <td></td> <td>10 m [32.81']</td> </tr> <tr> <td></td> <td>15 m [49.21']</td> </tr> </table> <p>other cable lengths (minimum order quantity 4 pieces)</p>	standard cable length	2 m [6.56']	(available from 1 piece)	5 m [16.40']		10 m [32.81']		15 m [49.21']	<p>05.00.6011.3533.002M 05.00.6011.3533.005M 05.00.6011.3533.010M 05.00.6011.3533.015M</p> <p>05.00.6011.3533.0xxM xx = length in meters: 1, 3, 8, 12, 20, 25, 30</p>
standard cable length	2 m [6.56']										
(available from 1 piece)	5 m [16.40']										
	10 m [32.81']										
	15 m [49.21']										

1) Other cable lengths on request.
2) Shield on housing.

Connection technology

M12 connection technology Cordsets, pre-assembled

With connector, 8 pin Working temp. -30°C ... +80°C [-22°F ... +176°F] Order no.

Female connector with coupling nut + single-ended
A coded, straight

Cable: PVC, 8 x 0.25 mm² [AWG23]
 Housing: metal / plastic, IP67

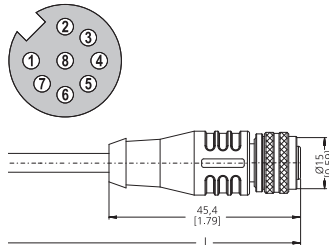

suitable for our series:

- 3610 / 3620 KIS50 / KIH50
- 5000 / 5020 5006 / 5026
- 5814 / 5834 5814FSx / 5834FSx
- 5821 A020 / A02H
- F3653 / F3673 5853 / 5873
- M3663 / M3683 M3663R / M3683R
- F3663 / F3683 F5863 / F5883
- 5863 / 5883
- F5883M F5888M
- C60, D120
- SP 1SC-2SC2D SP 2D-2D
- SK 1A-1S1D2RS SK 1S-1P
- PW 1D-1D

Terminal assignment

Pin female contacts:	1	2	3	4	5	6	7	8	PH ²⁾
Core color:	WH	BN	GN	YE	GY	PK	BU	RD	PH ²⁾

cable length ¹⁾

- standard cable length 2 m [6.56']
- (available from 1 piece) 5 m [16.40']
- 10 m [32.81']
- 15 m [49.21']

- 05.00.6041.8211.002M**
- 05.00.6041.8211.005M**
- 05.00.6041.8211.010M**
- 05.00.6041.8211.015M**

other cable lengths
 (minimum order quantity 4 pieces)

05.00.6041.8211.0xxM
 xx = length in meters:
 1, 3, 8, 12, 20, 25, 30

Female connector with coupling nut + single-ended
A coded, right-angle

Cable: PVC, 8 x 0.25 mm² [AWG23]
 Housing: metal / plastic, IP67

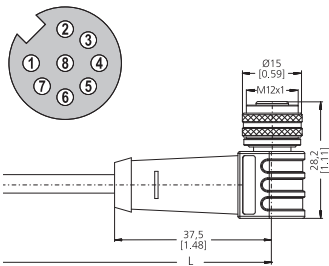

suitable for our series:

- 3610 / 3620 5000 / 5020
- 5814 / 5834 5814FSx / 5834FSx
- 5006 / 5026 5821
- A020 / A02H
- F3653 / F3673 5853 / 5873
- M3663 / M3683 M3663R / M3683R
- F3663 / F3683 F5863 / F5883
- 5863 / 5883 F5888M
- C60, D120
- SP 1SC-2SC2D SP 2D-2D
- SK 1A-1S1D2RS SK 1S-1P
- PW 1D-1D

Terminal assignment

Pin female contacts:	1	2	3	4	5	6	7	8	PH ²⁾
Core color:	WH	BN	GN	YE	GY	PK	BU	RD	PH ²⁾

cable length ¹⁾

- standard cable length 2 m [6.56']
- (available from 1 piece) 5 m [16.40']
- 10 m [32.81']
- 15 m [49.21']

- 05.00.6041.8311.002M**
- 05.00.6041.8311.005M**
- 05.00.6041.8311.010M**
- 05.00.6041.8311.015M**

other cable lengths
 (minimum order quantity 4 pieces)

05.00.6041.8311.0xxM
 xx = length in meters:
 1, 3, 8, 12, 20, 25, 30

1) Other cable lengths on request.
 2) Shield on housing.

Connection technology

M12 connection technology

Cordsets, pre-assembled

With connector, 8 pin

Working temp. -30°C ... +80°C [-22°F ... +176°F]

Order no.

Female connector with coupling nut + single-ended
A coded, straight

Cable: PUR, 8 x 0.25 mm² [AWG23]
Housing: metal / plastic, IP67

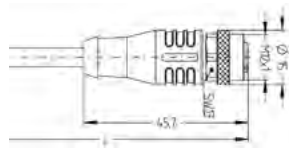
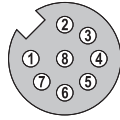

suitable for our series:

3610 / 3620 5000 / 5020
5814 / 5834 5814FSx / 5834FSx
5006 / 5026 5821
A020 / A02H
F3653 / F3673 5853 / 5873
M3663 / M3683 M3663R / M3683R
F3663 / F3683 F5863 / F5883
5863 / 5883 M5863

C60, D120
SP 1SC-2SC2D SP 2D-2D
SK 1A-1S1D2RS SK 1S-1P
PW 1D-1D
SR160

Terminal assignment

Pin female contacts:	1	2	3	4	5	6	7	8	PH ²⁾
Core color:	WH	BN	GN	YE	GY	PK	BU	RD	PH ²⁾

cable length¹⁾

standard cable length 2 m [6.56']
(available from 1 piece) 5 m [16.40']
10 m [32.81']
15 m [49.21']

05.00.6051.8211.002M
05.00.6051.8211.005M
05.00.6051.8211.010M
05.00.6051.8211.015M

other cable lengths
(minimum order quantity 4 pieces)

05.00.6051.8211.0xxM
xx = length in meters:
1, 3, 8, 12, 20, 25, 30

Female connector with coupling nut + single-ended
A coded, straight

Cable: PUR, 4 x 2 x 0,25 mm² [AWG23]
Housing: metal / plastic, IP67



Twisted-pair cables - for particularly interference-free transmission

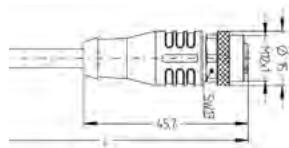
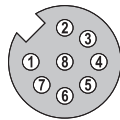

suitable for our series with RS422, RS485 or SinCos output:

3610 / 3620 5000 / 5020
5814 / 5834 5814FSx / 5834FSx
5006 / 5026 5821
A020 / A02H
F3653 / F3673 5853 / 5873
M3663 / M3683 M3663R / M3683R
F3663 / F3683 F5863 / F5883
5863 / 5883

C60, D120
SP 1SC-2SC2D SP 2D-2D
SK 1A-1S1D2RS SK 1S-1P
PW 1D-1D
SR160

Terminal assignment

Pin female contacts:	1	2	3	4	5	6	7	8	PH ²⁾
Core color:	WH	BN	GN	YE	GY	PK	BU	RD	PH ²⁾

cable length¹⁾

standard cable length 2 m [6.56']
(available from 1 piece) 5 m [16.40']
10 m [32.81']
15 m [49.21']

05.00.60E1.8211.002M
05.00.60E1.8211.005M
05.00.60E1.8211.010M
05.00.60E1.8211.015M

other cable lengths
(minimum order quantity 4 pieces)

05.00.60E1.8211.0xxM
xx = length in meters:
1, 3, 8, 12, 20, 25, 30

1) Other cable lengths on request.
2) Shield on housing.

Connection technology

M12 connection technology Cordsets, pre-assembled

With connector, 8 pin Working temp. -30°C ... +80°C [-22°F ... +176°F] Order no.

Female connector with coupling nut + single-ended
A coded, right-angle
with integrated control LEDs

Cable: PVC, 8 x 0.25 mm² [AWG23]
 Housing: metal / plastic, IP67

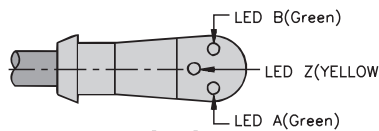
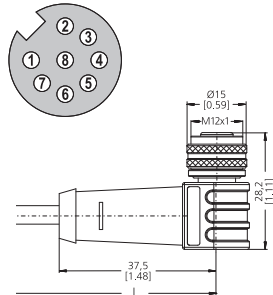

suitable for our series:

- 3610 / 3620 5006
- 5000 / 5020 5821
- A020 A02H
- C60, D120
- SP 1SC-2SC2D SP 2D-2D
- SK 1A-1S1D2RS SK 1S-1P
- PW 1D-1D

Terminal assignment

Pin female contacts:	1	2	3	4	5	6	7	8	PH ²⁾
Core color:	WH	BN	YE	GN	PK	GY	RD	BU	PH ²⁾

cable length ¹⁾

- 2 m [6.56']
- 5 m [16.40']
- 10 m [32.81']
- 15 m [49.21']

- 05.E-WKC 8T-PX3-930-0002**
- 05.E-WKC 8T-PX3-930-0005**
- 05.E-WKC 8T-PX3-930-0010**
- 05.E-WKC 8T-PX3-930-0015**

1) Other cable lengths on request.
 2) Shield on housing.

M12 connection technology

Cordsets, pre-assembled

With connector, 12 pin

Working temp. -30°C ... +90°C [-22°F ... +194°F]

Order no.

Female connector with coupling nut + single-ended
A coded, straight

Cable: PUR, 6 x 2 x 0.14 mm² [AWG25]
Housing: metal / plastic, IP67

suitable for our series:

RLA50
LA10
C100, D125

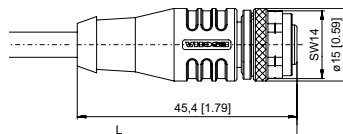
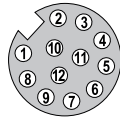

Terminal assignment

cable length ¹⁾

Pin female contacts:	1	2	3	4	5	6	7	8	9	10	11	12	PH ²⁾
Core color:	WH	BN	GN	YE	GY	PK	BU	RD	BK	VT	GY/PK	RD/BU	PH ²⁾

standard cable length	2 m [6.56']
(available from 1 piece)	5 m [16.40']
	10 m [32.81']
	15 m [49.21']

05.00.60B1.B211.002M
05.00.60B1.B211.005M
05.00.60B1.B211.010M
05.00.60B1.B211.015M

other cable lengths
(minimum order quantity 4 pieces)

05.00.60B1.B211.0xxM

xx = length in meters:
1, 3, 8, 12, 20, 25, 30

1) Other cable lengths on request.
2) Shield on housing.

X-ON Electronics

Largest Supplier of Electrical and Electronic Components

Click to view similar products for [Sensor Cables / Actuator Cables](#) category:

Click to view products by [Kubler](#) manufacturer:

Other Similar products are found below :

[1300070444](#) [43-10984](#) [M83513/19-F01CP](#) [704000D02F120](#) [MDM15SH001K](#) [MDM25PH003BF222](#) [802027107404-1](#) [885030A09M010](#)
[885030A09M020](#) [1200650174](#) [1200651332](#) [1200651713](#) [1200660171](#) [1200660208](#) [1200660343](#) [1200660804](#) [1200660845](#) [1200660926](#)
[1200660977](#) [1200661173](#) [1200661354](#) [120066-1712](#) [1200720053](#) [1200720099](#) [1200720153](#) [1200720172](#) [1200720217](#) [1200720226](#)
[1200720251](#) [1200720285](#) [1200720296](#) [1200720404](#) [1200730148](#) [1200730378](#) [1200800231](#) [1200860112](#) [1200860121](#) [1200860125](#)
[1200860337](#) [1200860365](#) [1200860420](#) [1200870046](#) [1200870248](#) [1200980102](#) [1200660181](#) [1200660183](#) [1200660827](#) [1200660849](#)
[1200661170](#) [1200661295](#)