

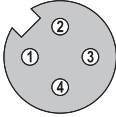







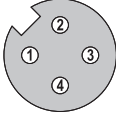

# Connection technology



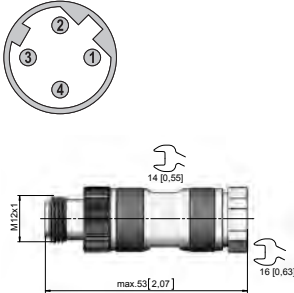



M12 connection technology		Connectors, self-assembly		Order no.
<b>4 pin</b>				
<p><b>Female connector with coupling nut</b> A coded, straight power supply</p> <p>Housing: plastic, IP67</p> 	<p>screw connections, for cable <math>\varnothing</math> 4 ... 6 mm [0.16 ... 0.24"]</p> 	<p>suitable for our series:</p> <p>5858 / 5878      5868 / 5888 F5858 / F5878    F5868 / F5888</p> <p>C60, D120</p> <p>EMIO.SIO.10xP</p>	<p><b>05.B8141-0</b></p>	
<p><b>Female connector with coupling nut</b> A coded, right-angle power supply</p> <p>Housing: plastic, IP67</p> 	<p>screw connections, for cable <math>\varnothing</math> 4 ... 6 mm [0.16 ... 0.24"]</p> 	<p>suitable for our series:</p> <p>5858 / 5878      5868 / 5888</p> <p>C60, D120</p> <p>EMIO.SIO.10xP</p>	<p><b>05.B8241-0</b></p>	
<p><b>Male connector with external thread</b> A coded, straight power supply</p> <p>Housing: metal / plastic, IP67</p> 	<p>screw connections, for cable <math>\varnothing</math> 4 ... 6 mm [0.16 ... 0.24"]</p> 	<p>suitable for:</p> <p>versions with cable outlet</p>	<p><b>05.BS8141-0</b></p>	
<p><b>Male connector with external thread</b> D coded, straight</p> <p>Housing: metal, IP67</p> 	<p>displacement/terminal connection, for cable <math>\varnothing</math> 4 ... 9 mm [0.16 ... 0.35"]</p> 	<p>suitable for our series:</p> <p>5858 / 5878      5868 / 5888 F5858 / F5878    F5868 / F5888</p> <p>SR120, SR160, SR250H</p> <p><b>EtherCAT</b> Conformance tested</p> <p><b>PROFINET</b></p> <p><b>EtherNet/IP</b></p>	<p><b>05.WASCSY4S</b></p>	



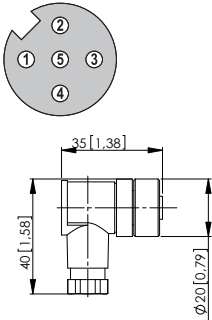

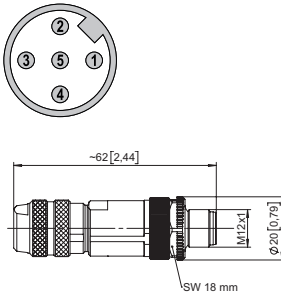

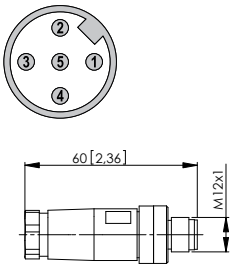

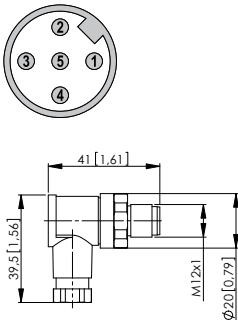
# Connection technology

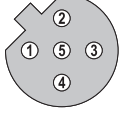
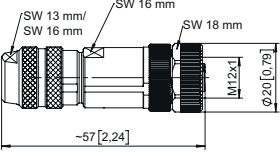
## M12 connection technology Connectors, self-assembly

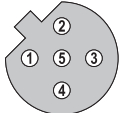
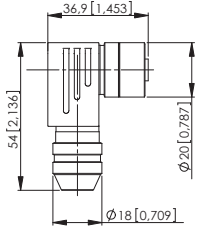
5 pin		Order no.															
<p><b>Female connector with coupling nut</b> <b>A coded, straight</b></p> <p>Housing: metal, IP67</p> 	<p>screw connections, for cable <math>\varnothing</math> 6 ... 8 mm [0.24 ... 0.32"]</p>	<p>suitable for our series:</p> <table border="0"> <tr> <td>3651 / 3671</td> <td>M3658 / M3678</td> </tr> <tr> <td>F3658 / F3658</td> <td>5858 / 5878</td> </tr> <tr> <td>M3661 / M3681</td> <td>M3661R</td> </tr> <tr> <td>M3668 / M3688</td> <td>M3668R</td> </tr> <tr> <td>F3668 / F3688</td> <td>F5868 / F5888</td> </tr> <tr> <td>M5861</td> <td>M5868</td> </tr> <tr> <td>5868 / 5888</td> <td>F5888M</td> </tr> </table> <p>A50, B80, C60, C100, C120, D120, D125, D135</p> <p>IS40, IS60, IN88</p> <p>SR120, SR160, SR250H</p> <p><b>CANopen</b> <b>DeviceNet</b></p>	3651 / 3671	M3658 / M3678	F3658 / F3658	5858 / 5878	M3661 / M3681	M3661R	M3668 / M3688	M3668R	F3668 / F3688	F5868 / F5888	M5861	M5868	5868 / 5888	F5888M	<p><b>8.0000.5116.0000</b></p>
3651 / 3671	M3658 / M3678																
F3658 / F3658	5858 / 5878																
M3661 / M3681	M3661R																
M3668 / M3688	M3668R																
F3668 / F3688	F5868 / F5888																
M5861	M5868																
5868 / 5888	F5888M																
<p><b>Female connector with coupling nut</b> <b>A coded, straight</b></p> <p>Housing: stainless steel V4A, IP67</p> 	<p>screw connections, for cable <math>\varnothing</math> 6 ... 8 mm [0.24 ... 0.32"]</p>	<p>suitable for our series:</p> <p>M3668R M3661R</p> <p><b>CANopen</b> <b>DeviceNet</b></p>	<p><b>8.0000.5116.0000.V4A</b></p>														
<p><b>Female connector with coupling nut</b> <b>A coded, straight</b></p> <p>Housing: metal, IP67</p> 	<p>screw connections, for cable <math>\varnothing</math> 6 ... 9 mm [0.24 ... 0.35"]</p>	<p>suitable for our series:</p> <p>ATEX zone 2/22 encoders</p> <p><b>Ex</b> 2/22</p> <p><b>CANopen</b> <b>DeviceNet</b></p>	<p><b>8.0000.5116.0000.Ex</b></p>														
<p><b>Female connector with coupling nut</b> <b>A coded, straight</b></p> <p>Housing: plastic, IP67</p> 	<p>screw connections, for cable <math>\varnothing</math> 4 ... 8 mm [0.16 ... 0.32"]</p>	<p>suitable for our series:</p> <p>3651 / 3671</p> <p>A50, B80, C60, C100, C120, D120, D125, D135</p> <p>IS40, IS60, IN88</p> <p><b>CANopen</b> <b>DeviceNet</b></p>	<p><b>05.B-8151-0/9</b></p>														

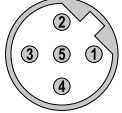
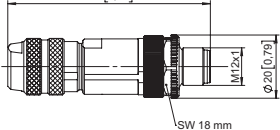
# Connection technology

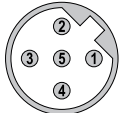
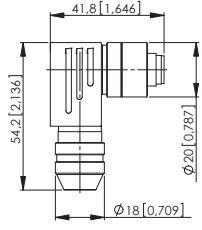
M12 connection technology		Connectors, self-assembly		Order no.
<b>5 pin</b>				
<p><b>Female connector with coupling nut</b>  <b>A coded, right-angle</b>            Housing: plastic, IP67</p> 	<p>screw connections,            for cable <math>\varnothing</math> 6 ... 8 mm [0.24 ... 0.32"]</p> 	<p>suitable for our series:</p> <p>3651 / 3671            A50, B80, C60, C100, C120, D120,            D125, D135            IS40, IS60, IN88</p> <p><b>CANopen</b>  <b>DeviceNet</b></p>	<p><b>05.B-8251-0/9</b></p>	
<p><b>Male connector with external thread</b>  <b>A coded, straight</b>            Housing: metal, IP67</p> 	<p>screw connections,            for cable <math>\varnothing</math> 6 ... 8 mm [0.24 ... 0.32"]</p> 	<p>suitable for our series:</p> <p>F3658 / F3658      F3668 / F3688            M3658 / M3678      M3668 / M3688            M3668R / M3688R            5858 / 5878      5868 / 5888            F5868 / F5888      F5888M</p> <p>IS60, IN88            SR120, SR160, SR250H</p> <p><b>CANopen</b>  <b>DeviceNet</b></p>	<p><b>8.0000.5111.0000</b></p>	
<p><b>Male connector with external thread</b>  <b>A coded, straight</b>            Housing: metal / plastic, IP67</p> 	<p>screw connections,            for cable <math>\varnothing</math> 6 ... 8 mm [0.24 ... 0.32"]</p> 	<p>suitable for our series:</p> <p>F3658 / F3658      F3668 / F3688            M3658 / M3678      M3668 / M3688            5858 / 5878      5868 / 5888            F5868 / F5888</p> <p>IS60, IN88            EMIO.SIO.10xP</p> <p><b>CANopen</b>  <b>DeviceNet</b></p>	<p><b>05.BS-8151-0/9</b></p>	
<p><b>Male connector with external thread</b>  <b>A coded, right-angle</b>            Housing: metal / plastic, IP67</p> 	<p>screw connections,            for cable <math>\varnothing</math> 6 ... 8 mm [0.24 ... 0.32"]</p> 	<p>suitable for our series:</p> <p>F3658 / F3658      F3668 / F3688            M3658 / M3678      M3668 / M3688            5858 / 5878      5868 / 5888            F5868 / F5888</p> <p>IS60, IN88</p> <p><b>CANopen</b>  <b>DeviceNet</b></p>	<p><b>05.BS-8251-0/9</b></p>	

M12 connection technology		Connectors, self-assembly		Order no.
<b>5 pin</b>				
<b>Female connector with coupling nut B coded, straight</b> Housing: metal, IP67 	screw connections, for cable $\varnothing$ 4 ... 9 mm [0.16 ... 0.35"]  	suitable for our series: 5858 / 5878      5868 / 5888 SR120, SR160, SR250H 	<b>05.BMWS 8151-8.5</b>	
<b>Female connector with coupling nut B coded, right-angle</b> Housing: metal, IP67 	screw connections, for cable $\varnothing$ 4 ... 9 mm [0.16 ... 0.35"]  	suitable for our series: 5858 / 5878      5868 / 5888 SR120, SR160, SR250H 	<b>05.BMWS 8251-8.5</b>	
<b>Male connector with external thread B coded, straight</b> Housing: metal, IP67 	screw connections, for cable $\varnothing$ 4 ... 9 mm [0.16 ... 0.35"]  	suitable for our series: 5858 / 5878      5868 / 5888 SR120, SR160, SR250H 	<b>05.BMSWS 8151-8.5</b>	
<b>Male connector with external thread B coded, right-angle</b> Housing: metal, IP67 	screw connections, for cable $\varnothing$ 4 ... 9 mm [0.16 ... 0.35"]  	suitable for our series: 5858 / 5878      5868 / 5888 SR120, SR160, SR250H 	<b>05.BMSWS 8251-8.5</b>	

# Connection technology

## M12 connection technology Connectors, self-assembly

**5 pin** Order no.

**Male connector with external thread  
D coded, straight**

Housing: metal, IP67



screw connections,  
for cable  $\varnothing 6 \dots 8 \text{ mm}$  [0.24 ... 0.32"]

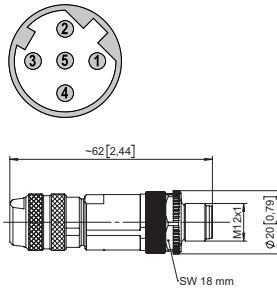

suitable for our series:

5858 / 5878	5868 / 5888
F5858 / F5878	F5868 / F5888

**8.0000.5121.0000.Ex**









**EtherCAT**  
Conformance tested

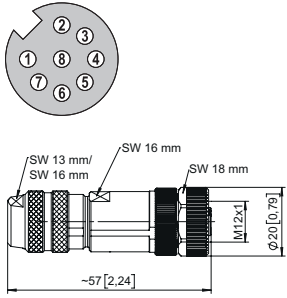

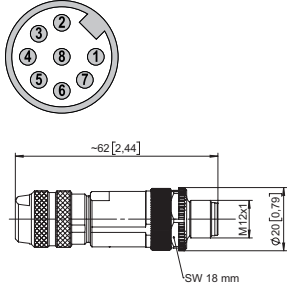
**EtherNet/IP**

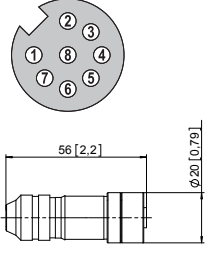
# Connection technology

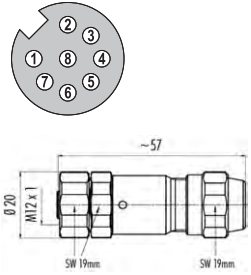



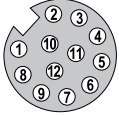
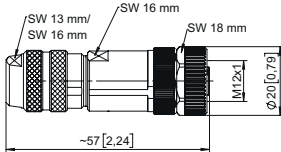

M12 connection technology		Connectors, self-assembly		Order no.
<b>8 pin</b>				
<b>Female connector with coupling nut</b> <b>A coded, straight</b> Housing: metal, IP67 	screw connections, for cable $\varnothing$ 6 ... 8 mm [0.24 ... 0.32"] 	suitable for our series: 3610 / 3620      KIS40 / KIH40 F3653 / F3673      F3663 / F3683 M3663 / M3683      M3663R 5000 / 5020      5006 / 5026 KIS50 / KIH50 5814 / 5834      58x4FSx 5853 / 5873      5863 / 5883 M5863 5821      F5883M H120      A020 / A02H C60, D120, D125	<b>05.CMB 8181-0</b>	
<b>Male connector with external thread</b> <b>A coded, straight</b> Housing: metal, IP67 	screw connections, for cable $\varnothing$ 6 ... 8 mm [0.24 ... 0.32"] 	suitable for: versions with cable outlet	<b>05.CMBS 8181-0</b>	
<b>Female connector with coupling nut</b> <b>A coded, straight</b> Housing: metal, IP67 	screw connections, for cable $\varnothing$ 6 ... 9 mm [0.24 ... 0.35"] 	suitable for our series: ATEX zone 2/22 encoders 	<b>8.0000.5136.0000.Ex</b>	
<b>Female connector with coupling nut</b> <b>A coded, straight</b> Housing: stainless steel V4A, IP67 	screw connections, for cable $\varnothing$ 6 ... 9 mm [0.24 ... 0.35"] 	suitable for our series: M3663R 5006 / 5026 A02H	<b>8.0000.5136.0000.V4A</b>	

# Connection technology

## M12 connection technology Connectors, self-assembly

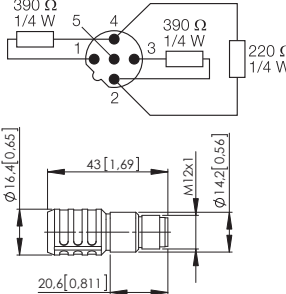
12 pin			Order no.
<p><b>Female connector with coupling nut</b>  <b>A coded, straight</b>                      Housing: metal, IP67</p> 	<p>screw connections,                      for cable <math>\varnothing</math> 6 ... 8 mm [0.24 ... 0.32"]</p>  	<p>suitable for:                      LA10</p>	<p><b>8.0000.5162.0000</b></p>

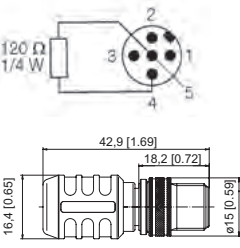

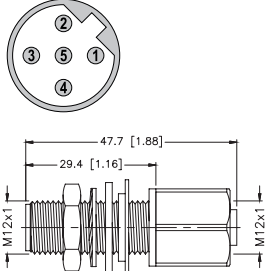
# Connection technology

M12 connection technology		Connectors, self-assembly		Order no.
<b>Accessories</b>				
<b>Securing clip for M12 connectors</b> Material: plastic 	against accidental disconnection under load  working temperature range -25°C ... +90°C [-13°F ... +194°F]	suitable for:  M12 connectors	<b>8.0000.5000.0006</b>	
<b>Terminating resistor</b> <b>Male connector with external thread</b> <b>B coded, straight</b> Housing: metal / plastic, IP67 		suitable for our series:  5858 / 5878      5868 / 5888	<b>05.RSS4.5-PDP-TR</b>	
<b>Terminating resistor</b> <b>Male connector with external thread</b> <b>A coded, straight</b> Housing: metal / plastic, IP67 		suitable for our series:  5858 / 5878      5868 / 5888 F5868 / F5888      F5888M  IN88	<b>05.RSE 57 TR2</b>	
<b>M12 lead-through</b> <b>B coded, straight</b> Housing: metal, IP67 		suitable for our series:  5858 / 5878      5868 / 5888	<b>05.FKW-FSW45/M12</b>	

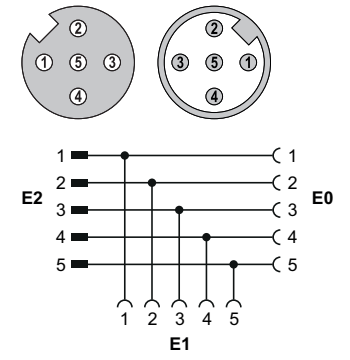

# Connection technology

## M12 connection technology Connectors, self-assembly

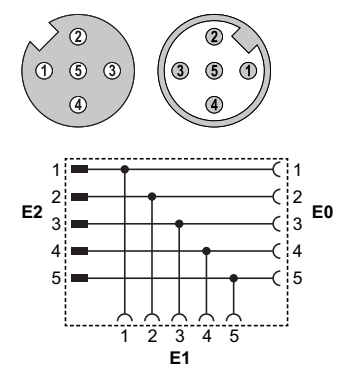
Accessories		Order no.	
<p><b>T-junction</b> A coded, 5 pin Housing: metal / plastic, IP67</p>	<p>2 x female connector with coupling nut 1 x male connector with external thread</p>  	<p>suitable for: M12 connectors</p> <p><i>DeviceNet</i></p>	<p><b>05.FKM5-FKM5-FSM5</b></p>
<p><b>T-junction, shielded</b> A coded, 5 pin Housing: metal / plastic, IP67</p>	<p>2 x female connector with coupling nut 1 x male connector with external thread</p>  	<p>suitable for: M12 connectors</p> <p><b>CANopen</b></p>	<p><b>05.WAKS5-WAKS5-WASS5</b></p>

# Connection technology

## M12 connection technology

## Cordsets, pre-assembled

### With connector, 4 pin

Working temp. -30°C ... +80°C [-22°F ... +176°F]

Order no.

**Female connector with coupling nut + single-ended**  
**A coded, straight power supply**

Cable: PUR, 4 x 0.34 mm<sup>2</sup> [AWG22]  
Housing: metal / plastic, IP67

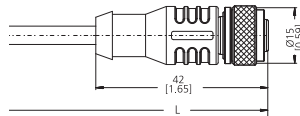
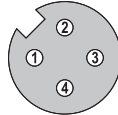

Terminal assignment

Pin female contacts:	1	2	3	4
Core color:	BN	WH	BU	BK

suitable for our series:

5858 / 5878      5868 / 5888  
F5858 / F5878      F5868 / F5888  
H120  
EMIO.SIO.10xP

*cable length*<sup>1)</sup>

standard cable length      2 m [6.56']  
(available from 1 piece)      5 m [16.40']  
10 m [32.81']  
15 m [49.21']

other cable lengths

(minimum order quantity 4 pieces)

**05.00.6061.6211.002M**  
**05.00.6061.6211.005M**  
**05.00.6061.6211.010M**  
**05.00.6061.6211.015M**

**05.00.6061.6211.0xxM**

xx = length in meters:  
1, 3, 8, 12, 20, 25, 30

**Female connector with coupling nut + male connector with external thread**  
**A coded, straight power supply**

Cable: PUR, 4 x 0.34 mm<sup>2</sup> [AWG22]  
Housing: metal / plastic, IP67

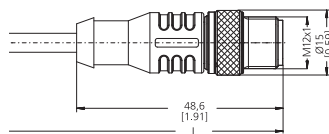
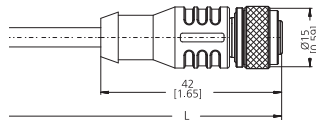
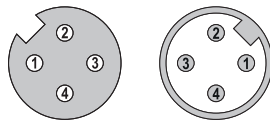

suitable for our series:

5858 / 5878      5868 / 5888  
EMIO.SIO.10xP

*cable length*<sup>1)</sup>

standard cable length      2 m [6.56']  
(available from 1 piece)      5 m [16.40']  
10 m [32.81']  
15 m [49.21']

other cable lengths

(minimum order quantity 4 pieces)

**05.00.6061.6462.002M**  
**05.00.6061.6462.005M**  
**05.00.6061.6462.010M**  
**05.00.6061.6462.015M**

**05.00.6061.6462.0xxM**

xx = length in meters:  
1, 3, 8, 12, 20, 25, 30

1) Other cable lengths on request.

# Connection technology

## M12 connection technology Cordsets, pre-assembled

With connector, 4 pin Working temp. -30°C ... +80°C [-22°F ... +176°F] Order no.

**Male connector with external thread**  
**single-ended**  
**D coded, straight**  
 Cable: PUR, 2 x 2 x 0.34 mm<sup>2</sup> [AWG22]  
 Housing: metal / plastic, IP67



Port A (1) and B (2)

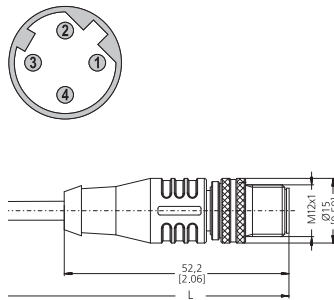

Working temp. -30°C ... +80°C [-22°F ... +176°F]

suitable for our series:  
 5858 / 5878 5868 / 5888  
 F5858 / F5878 F5868 / F5888  
 SR120, SR160, SR250H



**EtherNet/IP**

Terminal assignment

Pin male contacts:	1	2	3	4
Core color:	YE	OG	WH	BU

cable length <sup>1)</sup>

standard cable length 2 m [6.56']  
 (available from 1 piece) 5 m [16.40']  
 10 m [32.81']  
 15 m [49.21']

**05.00.6031.4411.002M**  
**05.00.6031.4411.005M**  
**05.00.6031.4411.010M**  
**05.00.6031.4411.015M**

other cable lengths  
 (minimum order quantity 4 pieces)

**05.00.6031.4411.0xxM**  
 xx = length in meters:  
 1, 3, 8, 12, 20, 25, 30

With connector, 5 pin Working temp. -30°C ... +80°C [-22°F ... +176°F] Order no.

**Female connector with coupling nut +**  
**single-ended**  
**A coded, straight**  
 Cable: PVC, 5 x 0.25 mm<sup>2</sup> [AWG23]  
 Housing: metal / plastic, IP67

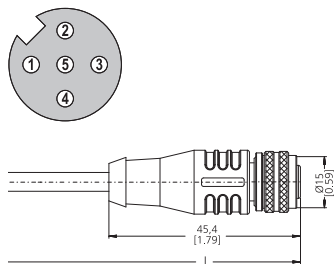

Working temp. -30°C ... +80°C [-22°F ... +176°F]

suitable for our series:  
 M3661 / M3681 M3661R  
 M5861  
 A50, B80, C120, D135  
 IS40  
 SR160, SR250H

Terminal assignment

Pin female contacts:	1	2	3	4	5	PH <sup>2)</sup>
Core color:	BN	WH	BU	BK	GY	PH <sup>2)</sup>

cable length <sup>1)</sup>

standard cable length 2 m [6.56']  
 (available from 1 piece) 5 m [16.40']  
 10 m [32.81']  
 15 m [49.21']

**05.00.6081.2211.002M**  
**05.00.6081.2211.005M**  
**05.00.6081.2211.010M**  
**05.00.6081.2211.015M**

other cable lengths  
 (minimum order quantity 4 pieces)

**05.00.6081.2211.0xxM**  
 xx = length in meters:  
 1, 3, 8, 12, 20, 25, 30

1) Other cable lengths on request.

# Connection technology

## M12 connection technology

## Cordsets, pre-assembled

### With connector, 5 pin

Working temp. -30°C ... +80°C [-22°F ... +176°F]

Order no.

#### Female connector with coupling nut + single-ended A coded, straight

Cable: PUR, 4 x 0.34 mm<sup>2</sup> [AWG22]  
Housing: metal / plastic, IP67



Bus-in

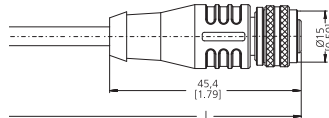
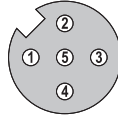

suitable for our series:

IS60, IN88  
SR160, SR250H

**DeviceNet**

*cable length*<sup>1)</sup>

standard cable length 2 m [6.56']  
(available from 1 piece) 5 m [16.40']  
10 m [32.81']  
15 m [49.21']

**05.00.6021.2211.002M**  
**05.00.6021.2211.005M**  
**05.00.6021.2211.010M**  
**05.00.6021.2211.015M**

other cable lengths  
(minimum order quantity 4 pieces)

**05.00.6021.2211.0xxM**  
xx = length in meters:  
1, 3, 8, 12, 20, 25, 30

*Terminal assignment*

Pin female contacts:	1	2	3	4	5
Core color:	± 3)	RD	BK	WH	BU

#### Female connector with coupling nut + single-ended A coded, straight

Cable: PVC,  
3 x 2 x 0.25 mm<sup>2</sup> [AWG23]  
Housing: metal / plastic, IP67



Bus-in

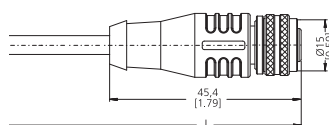
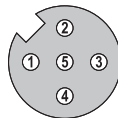

suitable for our series:

M3658 / M3678 M3668 / M3688  
M3668R  
5858 / 5878 5868 / 5888  
M5868 F5868 / F5888

C60, C100, D120, D125

IN88  
SR160, SR250H

**CANopen**

*cable length*<sup>1)</sup>

standard cable length 2 m [6.56']  
(available from 1 piece) 5 m [16.40']  
10 m [32.81']  
15 m [49.21']

**05.00.6091.A211.002M**  
**05.00.6091.A211.005M**  
**05.00.6091.A211.010M**  
**05.00.6091.A211.015M**

other cable lengths  
(minimum order quantity 4 pieces)

**05.00.6091.A211.0xxM**  
xx = length in meters:  
1, 3, 8, 12, 20, 25, 30

*Terminal assignment*

Pin female contacts:	1	2	3	4	5	PH <sup>2)</sup>
Core color:	GY	BN	WH	GN	YE	PH <sup>2)</sup>

1) Other cable lengths on request.  
2) Shield on housing.  
3) Shield with pin 1.

# Connection technology

## M12 connection technology Cordsets, pre-assembled

With connector, 5 pin Working temp. -30°C ... +80°C [-22°F ... +176°F] Order no.

**Male connector with external thread + single-ended**  
**A coded, straight**

Cable: PUR, 4 x 0.34 mm<sup>2</sup> [AWG22]  
 Housing: metal / plastic, IP67



Bus out

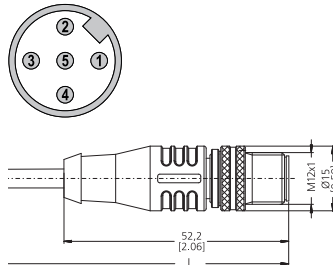

suitable for our series:

IS60, IN88  
 SR160, SR250H

**DeviceNet**

*cable length <sup>1)</sup>*

standard cable length 2 m [6.56']  
 (available from 1 piece) 5 m [16.40']  
 10 m [32.81']  
 15 m [49.21']

**05.00.6021.2411.002M**  
**05.00.6021.2411.005M**  
**05.00.6021.2411.010M**  
**05.00.6021.2411.015M**

other cable lengths  
 (minimum order quantity 4 pieces)

**05.00.6021.2411.0xxM**  
 xx = length in meters:  
 1, 3, 8, 12, 20, 25, 30

*Terminal assignment*

Pin male contacts:	1	2	3	4	5
Core color:	± 3)	RD	BK	WH	BU

**Male connector with external thread + single-ended**  
**A coded, straight**

Cable: PVC, 3 x 2 x 0.25 mm<sup>2</sup> [AWG23]  
 Housing: metal / plastic, IP67



Bus out

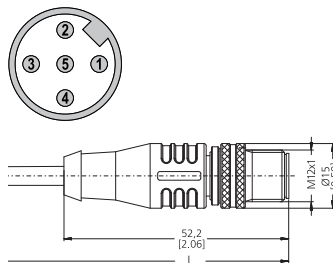

suitable for our series:

M3658 / M3678 F5868 / F5888  
 5858 / 5878 5868 / 5888

C60  
 IN88  
 SR160, SR250H  
 EMIO.SIO.10xP

**CANopen**

*cable length <sup>1)</sup>*

standard cable length 2 m [6.56']  
 (available from 1 piece) 5 m [16.40']  
 10 m [32.81']  
 15 m [49.21']

**05.00.6091.A411.002M**  
**05.00.6091.A411.005M**  
**05.00.6091.A411.010M**  
**05.00.6091.A411.015M**

other cable lengths  
 (minimum order quantity 4 pieces)

**05.00.6091.A411.0xxM**  
 xx = length in meters:  
 1, 3, 8, 12, 20, 25, 30



*Terminal assignment*

Pin male contacts:	1	2	3	4	5	PH <sup>2)</sup>
Core color:	GY	BN	WH	GN	YE	PH <sup>2)</sup>

1) Other cable lengths on request.  
 2) Shield on housing.  
 3) Shield with pin 1.

## M12 connection technology

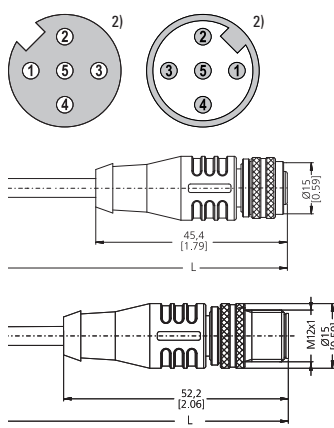
## Cordsets, pre-assembled

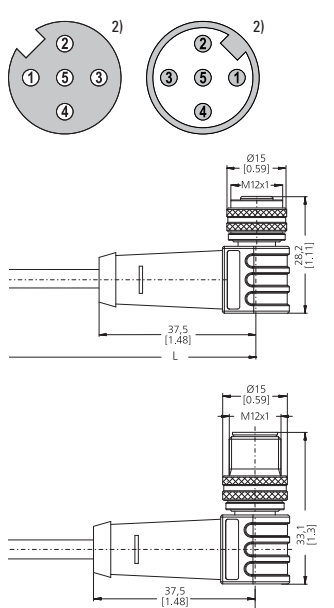
With connector, 5 pin		Working temp. -30°C ... +80°C [-22°F ... +176°F]	Order no.
<p><b>Female connector with coupling nut + male connector with external thread</b> <b>A coded, straight</b></p> <p>Cable: PUR, 2 x 0,25 mm<sup>2</sup> [AWG23] + 2 x 0,34 mm<sup>2</sup> [AWG22] Housing: metal / plastic, IP67</p> 	<p>Bus in / out</p> 	<p>suitable for our series:</p> <p>M3658 / M3678 F5868 / F5888 5858 / 5878 5868 / 5888</p> <p>C60, C100, D120, D125</p> <p>IS60, IN88</p> <p>SR160, SR250H</p> <p>EMIO.SIO.10xP</p> <p><b>CANopen</b> <b>DeviceNet</b></p> <p><i>cable length <sup>1)</sup></i></p> <p>standard cable length 2 m [6.56'] (available from 1 piece) 5 m [16.40'] 10 m [32.81'] 15 m [49.21']</p> <p>other cable lengths (minimum order quantity 4 pieces)</p>	<p><b>05.00.6021.2422.002M</b> <b>05.00.6021.2422.005M</b> <b>05.00.6021.2422.010M</b> <b>05.00.6021.2422.015M</b></p> <p><b>05.00.6021.2422.0xxM</b> xx = length in meters: 1, 3, 8, 12, 20, 25, 30</p>
<p><b>Female connector with coupling nut + male connector with external thread</b> <b>A coded, right-angle</b></p> <p>Cable: PUR, 2 x 0,25 mm<sup>2</sup> [AWG23] + 2 x 0,34 mm<sup>2</sup> [AWG22] Housing: metal / plastic, IP67</p> 	<p>Bus in / out</p> 	<p>suitable for our series:</p> <p>M3658 / M3678 F5868 / F5888 5858 / 5878 5868 / 5888</p> <p>C60, C100, D120, D125</p> <p>IS60, IN88</p> <p>SR160, SR250H</p> <p>EMIO.SIO.10xP</p> <p><b>CANopen</b> <b>DeviceNet</b></p> <p><i>cable length <sup>1)</sup></i></p> <p>standard cable length 2 m [6.56'] (available from 1 piece) 5 m [16.40'] 10 m [32.81'] 15 m [49.21']</p> <p>other cable lengths (minimum order quantity 4 pieces)</p>	<p><b>05.00.6021.2523.002M</b> <b>05.00.6021.2523.005M</b> <b>05.00.6021.2523.010M</b> <b>05.00.6021.2523.015M</b></p> <p><b>05.00.6021.2523.0xxM</b> xx = length in meters: 1, 3, 8, 12, 20, 25, 30</p>

1) Other cable lengths on request.  
2) Shield on housing.

# Connection technology

## M12 connection technology Cordsets, pre-assembled

**With connector, 5 pin** Working temp. -30°C ... +80°C [-22°F ... +176°F] Order no.

**Female connector with coupling nut + single-ended A coded, straight**

Cable: PVC, 3 x 2 x 0,25 mm<sup>2</sup> [AWG23]  
Housing: metal, IP67



Bus in

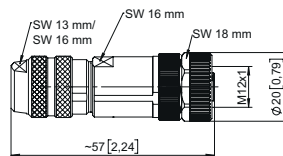
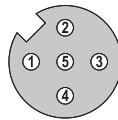

suitable for our series:

M3658 / M3678  
5858 / 5878 5868 / 5888  
C60, C100, D120, D125  
SR160, SR250H



Terminal assignment

Pin female contacts:	1	2	3	4	5	PH <sup>2)</sup>
Wire color:	GY	BN	WH	GN	YE	⊥

cable length<sup>1)</sup>

standard cable length 2 m [6.56']  
(available from 1 piece) 5 m [16.40']  
10 m [32.81']  
15 m [49.21']

**8.0000.6V81.0002**  
**8.0000.6V81.0005**  
**8.0000.6V81.0010**  
**8.0000.6V81.0015**

other cable lengths  
(minimum order quantity 4 pieces)

**8.0000.6V81.00xx**  
xx = length in meters:  
1, 3, 8, 12, 20, 25, 30

**Male connector with external thread + single-ended A coded, straight**

Cable: PVC, 3 x 2 x 0,25 mm<sup>2</sup> [AWG23]  
Housing: metal, IP67



Bus out

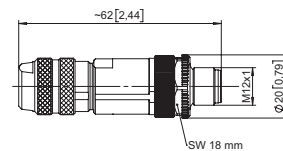
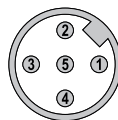

suitable for our series:

M3658 / M3678  
5858 / 5878 5868 / 5888  
SR160, SR250H



Terminal assignment

Pin male contacts:	1	2	3	4	5	PH <sup>2)</sup>
Core color:	GY	BN	WH	GN	YE	⊥

cable length<sup>1)</sup>

standard cable length 2 m [6.56']  
(available from 1 piece) 5 m [16.40']  
10 m [32.81']  
15 m [49.21']

**8.0000.6V88.0002**  
**8.0000.6V88.0005**  
**8.0000.6V88.0010**  
**8.0000.6V88.0015**

other cable lengths  
(minimum order quantity 4 pieces)

**8.0000.6V88.00xx**  
xx = length in meters:  
1, 3, 8, 12, 20, 25, 30

1) Other cable lengths on request.  
2) Shield on housing.

# Connection technology

## M12 connection technology

## Cordsets, pre-assembled

### With connector, 5 pin

Working temp. -30°C ... +80°C [-22°F ... +176°F]

Order no.

#### Female connector with coupling nut + single-ended B coded, straight

Cable: PUR, 2 x 0.34 mm<sup>2</sup> [AWG22]  
Housing: metal / plastic, IP67



Bus-in

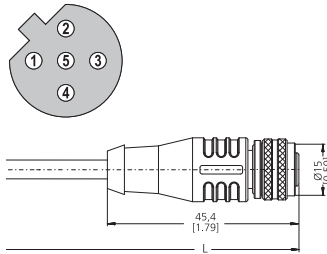

suitable for our series:

5858 / 5878      5868 / 5888  
SR120, SR160, SR250H



#### Terminal assignment

Pin female contacts:	1	2	3	4	5	PH <sup>2)</sup>
Core color:	n.c.	GN	n.c.	RD	n.c.	PH <sup>2)</sup>

cable length <sup>1)</sup>

standard cable length      2 m [6.56']  
(available from 1 piece)      5 m [16.40']  
10 m [32.81']  
15 m [49.21']

**05.00.6011.3211.002M**  
**05.00.6011.3211.005M**  
**05.00.6011.3211.010M**  
**05.00.6011.3211.015M**

other cable lengths  
(minimum order quantity 4 pieces)

**05.00.6011.3211.0xxM**  
xx = length in meters:  
1, 3, 8, 12, 20, 25, 30

#### Female connector with coupling nut + single-ended B coded, right-angle

Cable: PUR, 2 x 0.34 mm<sup>2</sup> [AWG22]  
Housing: metal / plastic, IP67



Bus-in

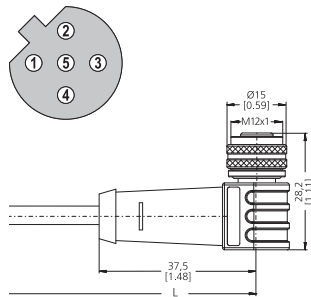

suitable for our series:

5858 / 5878      5868 / 5888  
SR120, SR160, SR250H



#### Terminal assignment

Pin female contacts:	1	2	3	4	5	PH <sup>2)</sup>
Core color:	n.c.	GN	n.c.	RD	n.c.	PH <sup>2)</sup>

cable length <sup>1)</sup>

standard cable length      2 m [6.56']  
(available from 1 piece)      5 m [16.40']  
10 m [32.81']  
15 m [49.21']

**05.00.6011.3311.002M**  
**05.00.6011.3311.005M**  
**05.00.6011.3311.010M**  
**05.00.6011.3311.015M**

other cable lengths  
(minimum order quantity 4 pieces)

**05.00.6011.3311.0xxM**  
xx = length in meters:  
1, 3, 8, 12, 20, 25, 30

1) Other cable lengths on request.  
2) Shield on housing.



# Connection technology

## M12 connection technology Cordsets, pre-assembled

With connector, 5 pin Working temp. -30°C ... +80°C [-22°F ... +176°F] Order no.

**Male connector with external thread + single-ended**  
**B coded, straight**

Cable: PUR, 2 x 0.34 mm<sup>2</sup> [AWG22]  
 Housing: metal / plastic, IP67



Bus-out

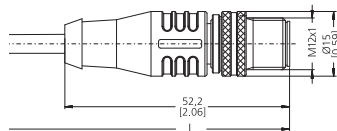
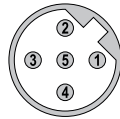

suitable for our series:

5858 / 5878 5868 / 5888  
 SR120, SR160, SR250H



Terminal assignment

Pin male contacts:	1	2	3	4	5	PH <sup>2)</sup>
Core color:	n.c.	GN	n.c.	RD	n.c.	PH <sup>2)</sup>

cable length <sup>1)</sup>

standard cable length 2 m [6.56']  
 (available from 1 piece) 5 m [16.40']  
 10 m [32.81']  
 15 m [49.21']

**05.00.6011.3411.002M**  
**05.00.6011.3411.005M**  
**05.00.6011.3411.010M**  
**05.00.6011.3411.015M**

other cable lengths  
 (minimum order quantity 4 pieces)

**05.00.6011.3411.0xxM**  
 xx = length in meters:  
 1, 3, 8, 12, 20, 25, 30

**Male connector with external thread + single-ended**  
**B coded, right-angle**

Cable: PUR, 2 x 0.34 mm<sup>2</sup> [AWG22]  
 Housing: metal / plastic, IP67



Bus-out

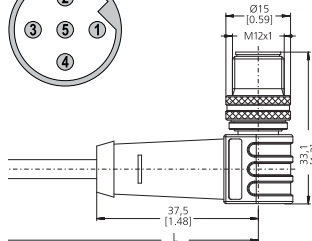
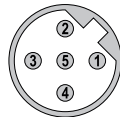

suitable for our series:

5858 / 5878 5868 / 5888  
 SR120, SR160, SR250H



Terminal assignment

Pin male contacts:	1	2	3	4	5	PH <sup>2)</sup>
Core color:	n.c.	GN	n.c.	RD	n.c.	PH <sup>2)</sup>

cable length <sup>1)</sup>

standard cable length 2 m [6.56']  
 (available from 1 piece) 5 m [16.40']  
 10 m [32.81']  
 15 m [49.21']

**05.00.6011.3511.002M**  
**05.00.6011.3511.005M**  
**05.00.6011.3511.010M**  
**05.00.6011.3511.015M**

other cable lengths  
 (minimum order quantity 4 pieces)





**05.00.6011.3511.0xxM**  
 xx = length in meters:  
 1, 3, 8, 12, 20, 25, 30

1) Other cable lengths on request.  
 2) Shield on housing.

# Connection technology

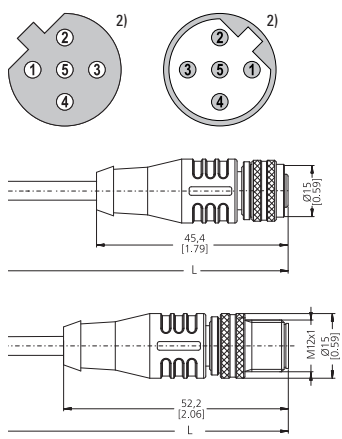
## M12 connection technology

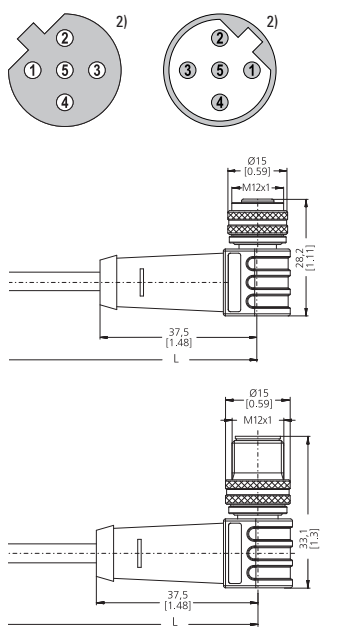
## Cordsets, pre-assembled

With connector, 5 pin		Working temp. -30°C ... +80°C [-22°F ... +176°F]	Order no.								
<p><b>Female connector with coupling nut + male connector with external thread B coded, straight</b></p> <p>Cable: PUR, 2 x 0.34 mm<sup>2</sup> [AWG22] Housing: metal / plastic, IP67</p> 	<p>Bus in / out</p> 	<p>suitable for our series:</p> <p>5858 / 5878      5868 / 5888 SR120, SR160, SR250H</p>  <p><i>cable length</i><sup>1)</sup></p> <table border="0"> <tr> <td>standard cable length</td> <td>2 m [6.56']</td> </tr> <tr> <td>(available from 1 piece)</td> <td>5 m [16.40']</td> </tr> <tr> <td></td> <td>10 m [32.81']</td> </tr> <tr> <td></td> <td>15 m [49.21']</td> </tr> </table> <p>other cable lengths (minimum order quantity 4 pieces)</p>	standard cable length	2 m [6.56']	(available from 1 piece)	5 m [16.40']		10 m [32.81']		15 m [49.21']	<p><b>05.00.6011.3432.002M</b> <b>05.00.6011.3432.005M</b> <b>05.00.6011.3432.010M</b> <b>05.00.6011.3432.015M</b></p> <p><b>05.00.6011.3432.0xxM</b> xx = length in meters: 1, 3, 8, 12, 20, 25, 30</p>
standard cable length	2 m [6.56']										
(available from 1 piece)	5 m [16.40']										
	10 m [32.81']										
	15 m [49.21']										
<p><b>Female connector with coupling nut + male connector with external thread B coded, right-angle</b></p> <p>Cable: PUR, 2 x 0.34 mm<sup>2</sup> [AWG22] Housing: metal / plastic, IP67</p> 	<p>Bus in / out</p> 	<p>suitable for our series:</p> <p>5858 / 5878      5868 / 5888 SR120, SR160, SR250H</p>  <p><i>cable length</i><sup>1)</sup></p> <table border="0"> <tr> <td>standard cable length</td> <td>2 m [6.56']</td> </tr> <tr> <td>(available from 1 piece)</td> <td>5 m [16.40']</td> </tr> <tr> <td></td> <td>10 m [32.81']</td> </tr> <tr> <td></td> <td>15 m [49.21']</td> </tr> </table> <p>other cable lengths (minimum order quantity 4 pieces)</p>	standard cable length	2 m [6.56']	(available from 1 piece)	5 m [16.40']		10 m [32.81']		15 m [49.21']	<p><b>05.00.6011.3533.002M</b> <b>05.00.6011.3533.005M</b> <b>05.00.6011.3533.010M</b> <b>05.00.6011.3533.015M</b></p> <p><b>05.00.6011.3533.0xxM</b> xx = length in meters: 1, 3, 8, 12, 20, 25, 30</p>
standard cable length	2 m [6.56']										
(available from 1 piece)	5 m [16.40']										
	10 m [32.81']										
	15 m [49.21']										

1) Other cable lengths on request.  
2) Shield on housing.

# Connection technology

## M12 connection technology Cordsets, pre-assembled

With connector, 8 pin Working temp. -30°C ... +80°C [-22°F ... +176°F] Order no.

**Female connector with coupling nut + single-ended**  
**A coded, straight**

Cable: PVC, 8 x 0.25 mm<sup>2</sup> [AWG23]  
 Housing: metal / plastic, IP67

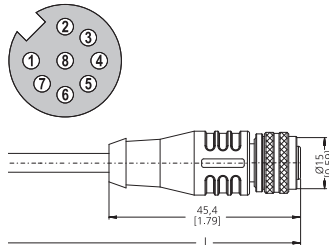

suitable for our series:

- 3610 / 3620 KIS50 / KIH50
- 5000 / 5020 5006 / 5026
- 5814 / 5834 5814FSx / 5834FSx
- 5821 A020 / A02H
- F3653 / F3673 5853 / 5873
- M3663 / M3683 M3663R / M3683R
- F3663 / F3683 F5863 / F5883
- 5863 / 5883
- F5883M F5888M
- C60, D120
- SP 1SC-2SC2D SP 2D-2D
- SK 1A-1S1D2RS SK 1S-1P
- PW 1D-1D

*Terminal assignment*

Pin female contacts:	1	2	3	4	5	6	7	8	PH <sup>2)</sup>
Core color:	WH	BN	GN	YE	GY	PK	BU	RD	PH <sup>2)</sup>

*cable length <sup>1)</sup>*

- standard cable length 2 m [6.56']
- (available from 1 piece) 5 m [16.40']
- 10 m [32.81']
- 15 m [49.21']

- 05.00.6041.8211.002M**
- 05.00.6041.8211.005M**
- 05.00.6041.8211.010M**
- 05.00.6041.8211.015M**

other cable lengths  
 (minimum order quantity 4 pieces)

**05.00.6041.8211.0xxM**  
 xx = length in meters:  
 1, 3, 8, 12, 20, 25, 30

**Female connector with coupling nut + single-ended**  
**A coded, right-angle**

Cable: PVC, 8 x 0.25 mm<sup>2</sup> [AWG23]  
 Housing: metal / plastic, IP67

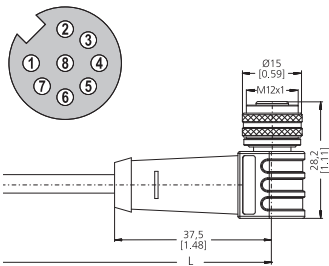

suitable for our series:

- 3610 / 3620 5000 / 5020
- 5814 / 5834 5814FSx / 5834FSx
- 5006 / 5026 5821
- A020 / A02H
- F3653 / F3673 5853 / 5873
- M3663 / M3683 M3663R / M3683R
- F3663 / F3683 F5863 / F5883
- 5863 / 5883 F5888M
- C60, D120
- SP 1SC-2SC2D SP 2D-2D
- SK 1A-1S1D2RS SK 1S-1P
- PW 1D-1D

*Terminal assignment*

Pin female contacts:	1	2	3	4	5	6	7	8	PH <sup>2)</sup>
Core color:	WH	BN	GN	YE	GY	PK	BU	RD	PH <sup>2)</sup>

*cable length <sup>1)</sup>*

- standard cable length 2 m [6.56']
- (available from 1 piece) 5 m [16.40']
- 10 m [32.81']
- 15 m [49.21']

- 05.00.6041.8311.002M**
- 05.00.6041.8311.005M**
- 05.00.6041.8311.010M**
- 05.00.6041.8311.015M**

other cable lengths  
 (minimum order quantity 4 pieces)

**05.00.6041.8311.0xxM**  
 xx = length in meters:  
 1, 3, 8, 12, 20, 25, 30

1) Other cable lengths on request.  
 2) Shield on housing.

# Connection technology

## M12 connection technology

## Cordsets, pre-assembled

### With connector, 8 pin

Working temp. -30°C ... +80°C [-22°F ... +176°F]

Order no.

#### Female connector with coupling nut + single-ended A coded, straight

Cable: PUR, 8 x 0.25 mm<sup>2</sup> [AWG23]  
Housing: metal / plastic, IP67

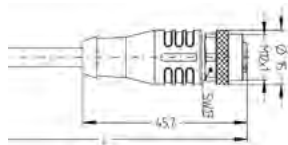
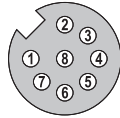

suitable for our series:

3610 / 3620      5000 / 5020  
5814 / 5834      5814FSx / 5834FSx  
5006 / 5026      5821  
A020 / A02H  
F3653 / F3673      5853 / 5873  
M3663 / M3683      M3663R / M3683R  
F3663 / F3683      F5863 / F5883  
5863 / 5883      M5863

C60, D120  
SP 1SC-2SC2D      SP 2D-2D  
SK 1A-1S1D2RS      SK 1S-1P  
PW 1D-1D  
SR160

#### Terminal assignment

Pin female contacts:	1	2	3	4	5	6	7	8	PH <sup>2)</sup>
Core color:	WH	BN	GN	YE	GY	PK	BU	RD	PH <sup>2)</sup>

cable length <sup>1)</sup>

standard cable length      2 m [6.56']  
(available from 1 piece)      5 m [16.40']  
10 m [32.81']  
15 m [49.21']

**05.00.6051.8211.002M**  
**05.00.6051.8211.005M**  
**05.00.6051.8211.010M**  
**05.00.6051.8211.015M**

other cable lengths  
(minimum order quantity 4 pieces)

**05.00.6051.8211.0xxM**  
xx = length in meters:  
1, 3, 8, 12, 20, 25, 30

#### Female connector with coupling nut + single-ended A coded, straight

Cable: PUR, 4 x 2 x 0,25 mm<sup>2</sup> [AWG23]  
Housing: metal / plastic, IP67



#### Twisted-pair cables - for particularly interference-free transmission

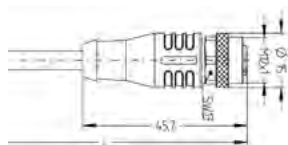
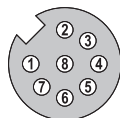

suitable for our series with RS422, RS485 or SinCos output:

3610 / 3620      5000 / 5020  
5814 / 5834      5814FSx / 5834FSx  
5006 / 5026      5821  
A020 / A02H  
F3653 / F3673      5853 / 5873  
M3663 / M3683      M3663R / M3683R  
F3663 / F3683      F5863 / F5883  
5863 / 5883

C60, D120  
SP 1SC-2SC2D      SP 2D-2D  
SK 1A-1S1D2RS      SK 1S-1P  
PW 1D-1D  
SR160

#### Terminal assignment

Pin female contacts:	1	2	3	4	5	6	7	8	PH <sup>2)</sup>
Core color:	WH	BN	GN	YE	GY	PK	BU	RD	PH <sup>2)</sup>

cable length <sup>1)</sup>

standard cable length      2 m [6.56']  
(available from 1 piece)      5 m [16.40']  
10 m [32.81']  
15 m [49.21']

**05.00.60E1.8211.002M**  
**05.00.60E1.8211.005M**  
**05.00.60E1.8211.010M**  
**05.00.60E1.8211.015M**

other cable lengths  
(minimum order quantity 4 pieces)

**05.00.60E1.8211.0xxM**  
xx = length in meters:  
1, 3, 8, 12, 20, 25, 30

1) Other cable lengths on request.  
2) Shield on housing.

# Connection technology

## M12 connection technology Cordsets, pre-assembled

With connector, 8 pin Working temp. -30°C ... +80°C [-22°F ... +176°F] Order no.

**Female connector with coupling nut + single-ended**  
**A coded, right-angle**  
**with integrated control LEDs**

Cable: PVC, 8 x 0.25 mm<sup>2</sup> [AWG23]  
 Housing: metal / plastic, IP67

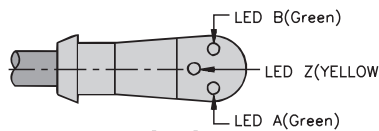
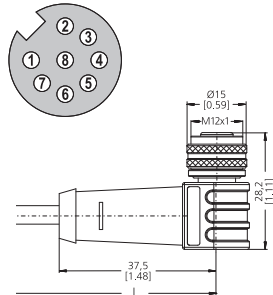

suitable for our series:

- 3610 / 3620 5006
- 5000 / 5020 5821
- A020 A02H
- C60, D120
- SP 1SC-2SC2D SP 2D-2D
- SK 1A-1S1D2RS SK 1S-1P
- PW 1D-1D

*Terminal assignment*

Pin female contacts:	1	2	3	4	5	6	7	8	PH <sup>2)</sup>
Core color:	WH	BN	YE	GN	PK	GY	RD	BU	PH <sup>2)</sup>

*cable length <sup>1)</sup>*

- 2 m [6.56']
- 5 m [16.40']
- 10 m [32.81']
- 15 m [49.21']

- 05.E-WKC 8T-PX3-930-0002**
- 05.E-WKC 8T-PX3-930-0005**
- 05.E-WKC 8T-PX3-930-0010**
- 05.E-WKC 8T-PX3-930-0015**

1) Other cable lengths on request.  
 2) Shield on housing.

## M12 connection technology

## Cordsets, pre-assembled

With connector, 12 pin

Working temp. -30°C ... +90°C [-22°F ... +194°F]

Order no.

**Female connector with coupling nut + single-ended**  
**A coded, straight**

Cable: PUR, 6 x 2 x 0.14 mm<sup>2</sup> [AWG25]  
Housing: metal / plastic, IP67

suitable for our series:

RLA50  
LA10  
C100, D125

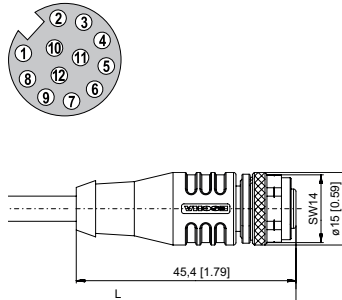

Terminal assignment

cable length <sup>1)</sup>

Pin female contacts:	1	2	3	4	5	6	7	8	9	10	11	12	PH <sup>2)</sup>
Core color:	WH	BN	GN	YE	GY	PK	BU	RD	BK	VT	GY/PK	RD/BU	PH <sup>2)</sup>

standard cable length	2 m [6.56']
(available from 1 piece)	5 m [16.40']
	10 m [32.81']
	15 m [49.21']

**05.00.60B1.B211.002M**  
**05.00.60B1.B211.005M**  
**05.00.60B1.B211.010M**  
**05.00.60B1.B211.015M**

other cable lengths  
(minimum order quantity 4 pieces)

**05.00.60B1.B211.0xxM**

xx = length in meters:  
1, 3, 8, 12, 20, 25, 30

1) Other cable lengths on request.  
2) Shield on housing.

## X-ON Electronics

Largest Supplier of Electrical and Electronic Components

*Click to view similar products for [Sensor Cables / Actuator Cables](#) category:*

*Click to view products by [Kubler](#) manufacturer:*

Other Similar products are found below :

[60963](#) [60964](#) [M83513/19-F01CP](#) [703000D02F2002](#) [703000D02F300](#) [703001D02F0602](#) [703001D02F1201](#) [703001D02F300](#)  
[704000D02F120](#) [773032K02F030](#) [802027107404-1](#) [802027213811-1](#) [804001A09M150](#) [805001A09M0502](#) [84914-0235](#) [84914-0237](#)  
[885030A09M010](#) [885030A09M020](#) [8R4J30E03C3003](#) [1200651332](#) [1200651713](#) [1200660844](#) [1200660845](#) [1200661173](#) [1200680071](#)  
[1200720053](#) [1200720081](#) [1200720099](#) [1200720217](#) [1200800231](#) [1200860125](#) [1200870123](#) [1200980102](#) [1200650218](#) [1200650298](#)  
[1200660183](#) [1200660782](#) [1200660849](#) [1200661295](#) [1200661297](#) [1200661342](#) [1200661343](#) [1200670080](#) [1200670220](#) [1200680331](#)  
[1200720252](#) [1200720255](#) [1200720597](#) [1200730184](#) [1200860344](#)