

Part No. 1000146

Wi-Fi 6 & Wi-Fi 6E or CBRS/n78 Stamped Metal Embedded Antenna

2.4 / 5 GHz or 3.3 – 3.8 GHz

Supports: Wi-Fi applications, Agriculture, Bluetooth, Zigbee, WLAN, Smart Home, Healthcare, Digital Signage

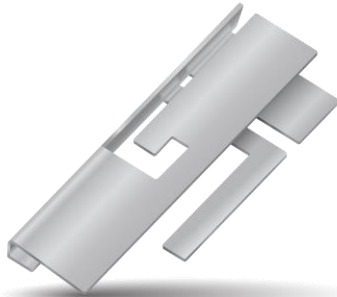

*CBRS/n78 layout offered in Appendix 1

**Wi-Fi 6 & Wi-Fi 6E or CBRS/n78
 Stamped Metal Embedded Antenna**
 2.400 GHz – 2.485 GHz;
 3.300 - 3.800 GHz;
 5.150 GHz – 5.825 GHz;
 5.975 GHz – 7.125 GHz

KEY BENEFITS

Stay-in-Tune

KYOCERA AVX antenna technology provides superior RF field containment, resulting in less interaction with surrounding components.

Quicker Time-to-Market

By optimizing antenna size, performance and emissions, customer and regulatory specifications are more easily met.

Reliability

Products are the latest RoHS version compliant

APPLICATIONS

- Embedded design
- Cellular, Headsets, Tablets
- Gateway, Access Point
- Handheld
- Telematics
- Tracking
- Healthcare
- M2M, Industrial devices
- Smart Grid
- OBD-II

KYOCERA AVX Stamped Metal series of Isolated Magnetic Dipole™ (IMD) antennas deliver on the key needs of device designers for higher functionality and performance in smaller/thinner designs. These innovative antennas provide compelling advantages for full WIFI 6 and WiFi 6E handheld devices, media players and other mobile devices. 1000146 Automotive A-series version offered.

Greater Flexibility

KYOCERA AVX first-in-class IMD technology enables you to develop concept designs that are more advanced and that deliver superior performance in reception critical applications. The 1000146 can also achieve CBRS/n78 performance with proper tuning and layout shown on Appendix 1.

Electrical Specifications

Typical Characteristics, on 125 x 45 mm PCB

Frequency (GHz)	2.400 – 2.485	5150 – 5.825	5925 - 7125	3.300– 3.800
Peak Gain	1.7 dBi	4.1 dBi	3.8 dBi	Refer to Appendix 1
Average Efficiency	81%	68%	64%	
VSWR Match	2.0:1 max	2.0:1 max	2.2:1 max	
Feed Point Impedance	50 ohms unbalanced			
Polarization	Linear			
Power Handling	0.5 Watt CW			

Mechanical Specifications & Ordering Part Number

Ordering Part Number	1000146
Size (mm)	17.85 x 6.9 x 4.3
Mounting	SMT
Weight (grams)	0.35
Packaging	Tape & Reel, 1000146 – 1,200 pieces per reel
Demo Board	1005456 (WiFi/WiFi6E) 1000146-03 (n78/CBRS)

Wi-Fi 6 & Wi-Fi 6E KYOCERA AVX Stamped Metal Embedded Antenna.
 KYOCERA AVX produces a wide variety of standard and custom antennas to meet user needs.

Antenna Dimensions

Typical antenna dimensions (mm)

Part Number	A	B	C
1000146	17.85 ± 0.3	6.9 ± 0.3	4.3 ± 0.4

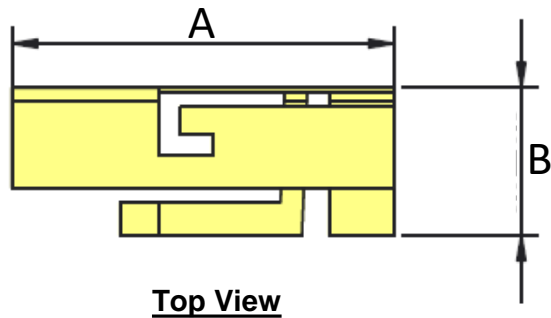
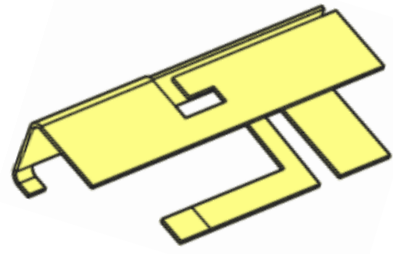

Height

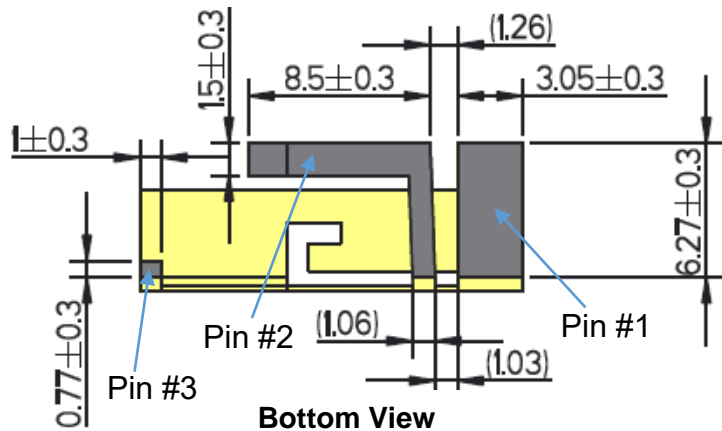

Pin	Description
1	Feed
2	Ground
3	Dummy Pad

Wi-Fi 6 & Wi-Fi 6E KYOCERA AVX Stamped Metal Embedded Antenna.
KYOCERA AVX produces a wide variety of standard and custom antennas to meet user needs.

Test Setup (1005456)

Typical Performance on 125 x 45 mm PCB

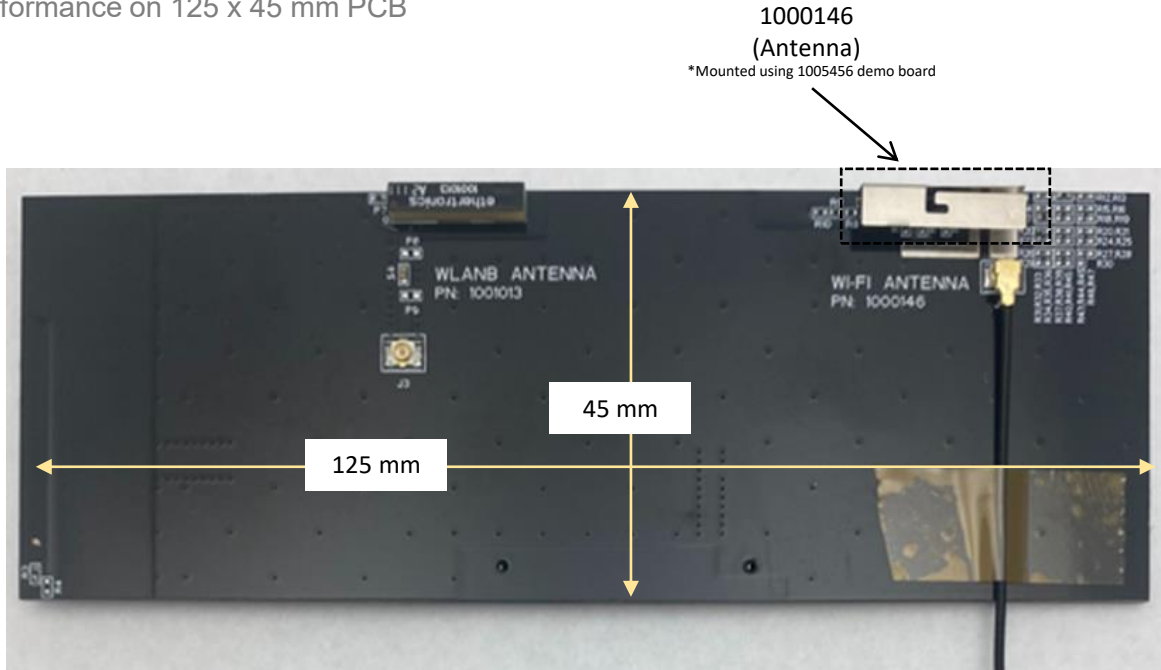

Wi-Fi 6 & Wi-Fi 6E KYOCERA AVX Stamped Metal Embedded Antenna.
 KYOCERA AVX produces a wide variety of standard and custom antennas to meet user needs.

VSWR, Efficiency, and Peak Gain Plots

Typical Performance on 125 x 45 mm PCB

**VSWR
(2.400 – 2.490) GHz**

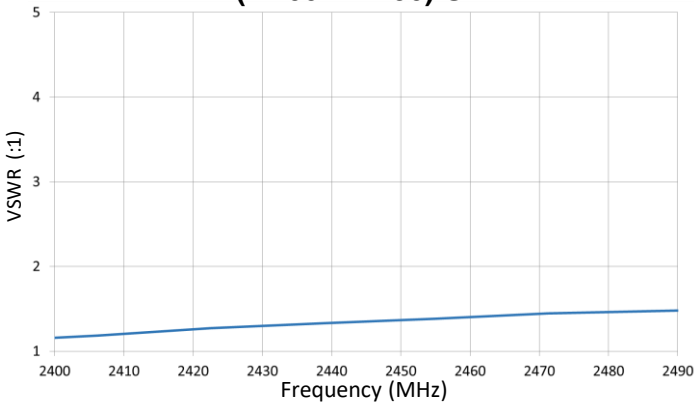

**VSWR
(5.100 – 7.200) GHz**

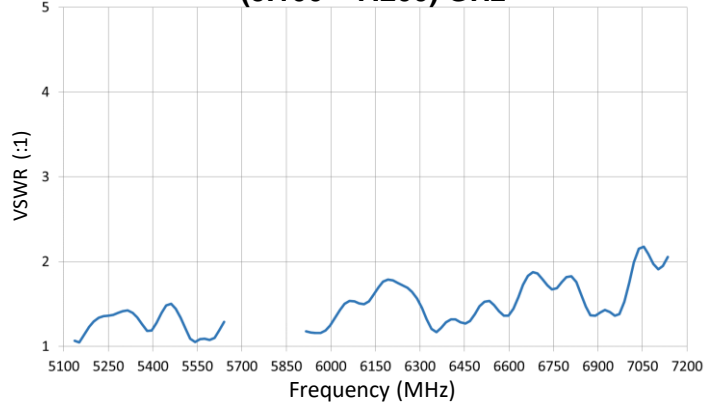

**Efficiency
(2.400 – 2.490) GHz**

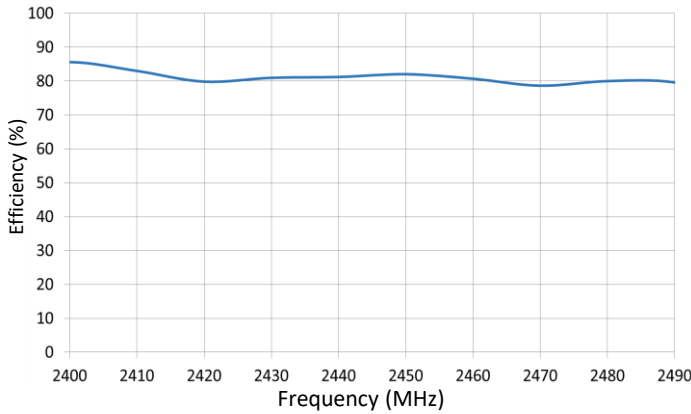

**Efficiency
(5.100 – 7.200) GHz**

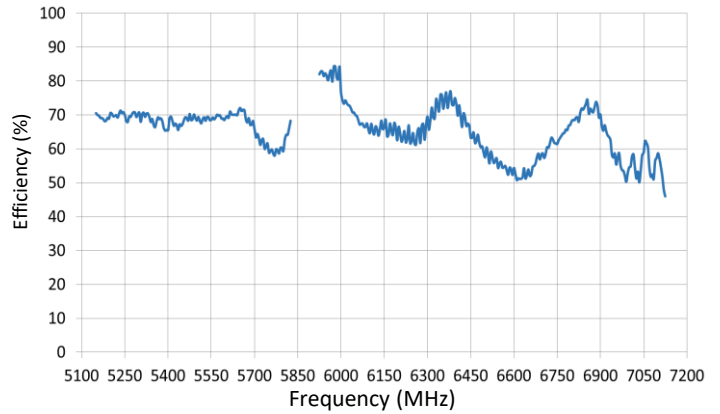

**Peak Gain
(2.400 – 2.490) GHz**

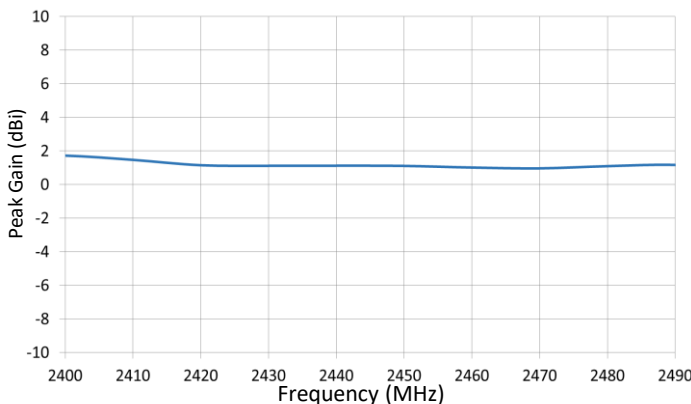

**Peak Gain
(5.100 – 7.200) GHz**

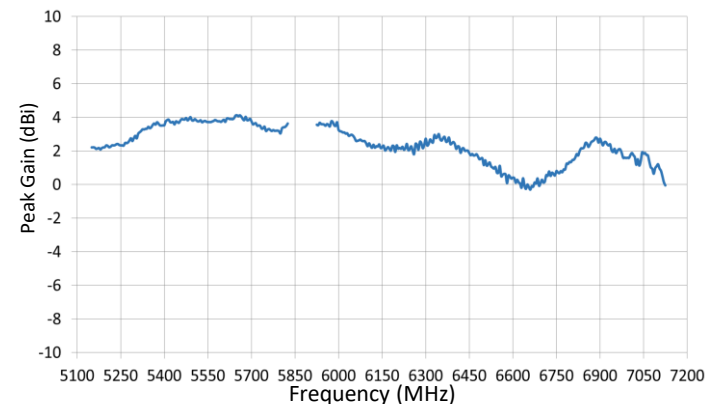

Wi-Fi 6 & Wi-Fi 6E KYOCERA AVX Stamped Metal Embedded Antenna.
 KYOCERA AVX produces a wide variety of standard and custom antennas to meet user needs.

Antenna Radiation Patterns

Typical Performance on 125 x 45 mm PCB
 Measured @ 2.440 GHz

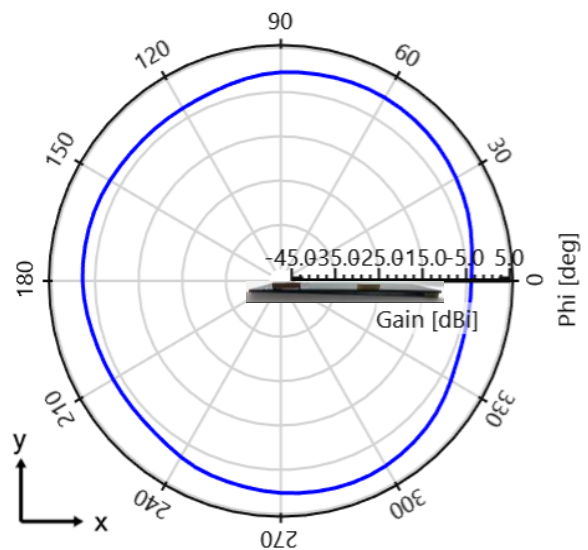
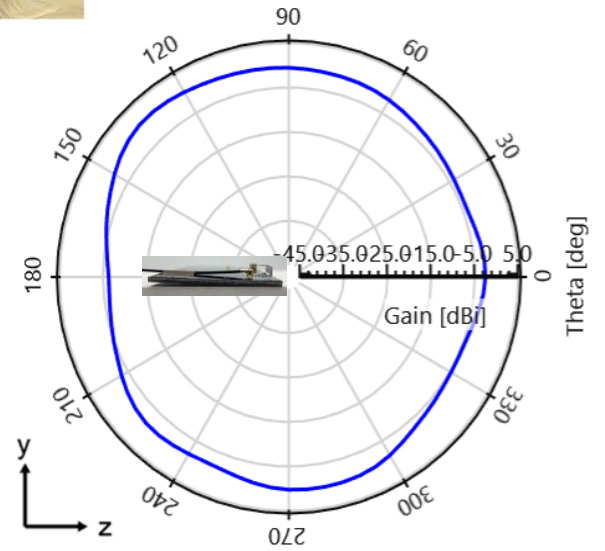
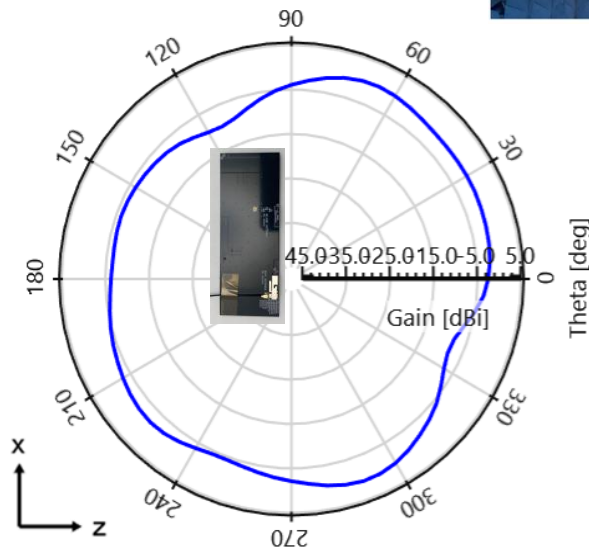
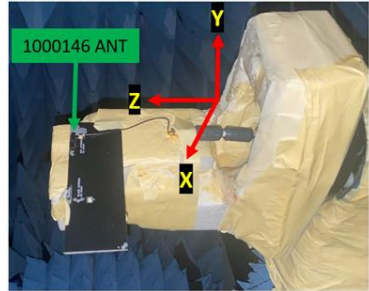

Wi-Fi 6 & Wi-Fi 6E KYOCERA AVX Stamped Metal Embedded Antenna.
 KYOCERA AVX produces a wide variety of standard and custom antennas to meet user needs.

Antenna Radiation Patterns

Typical Performance on 125 x 45 mm PCB
 Measured @ 5.550 GHz

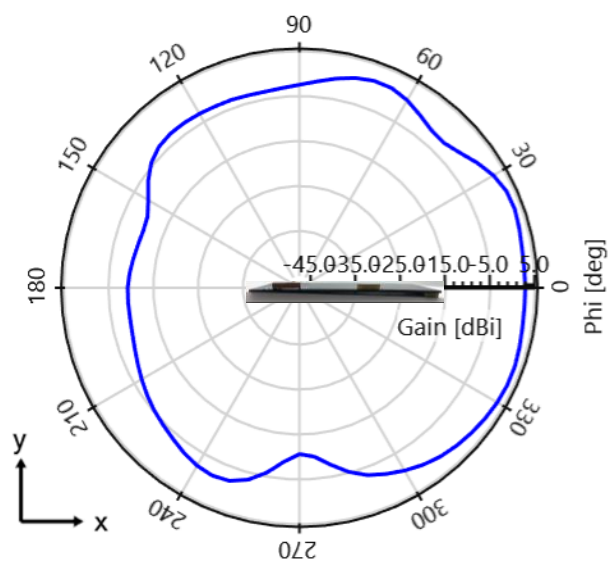
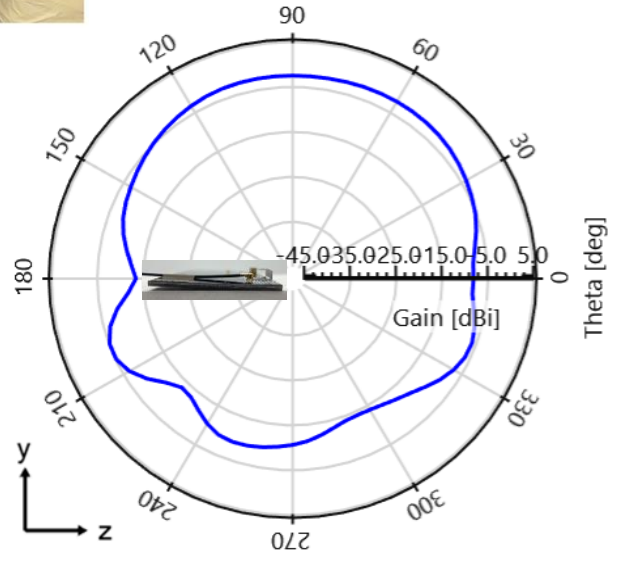
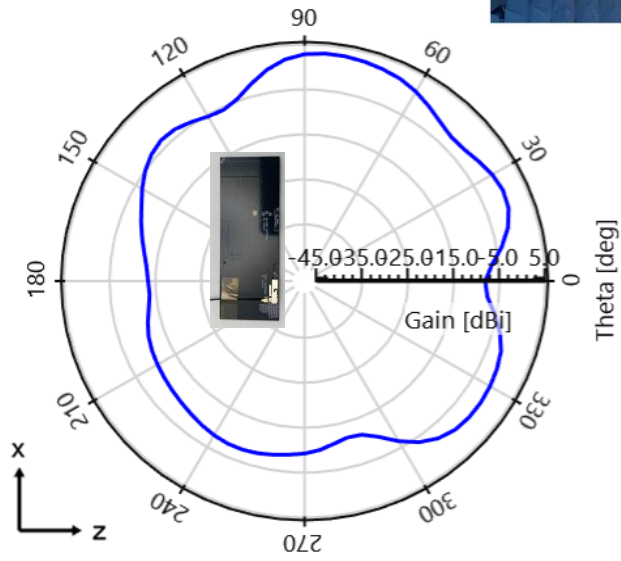
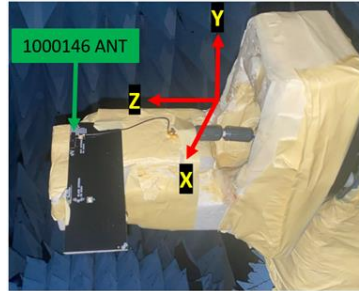

Wi-Fi 6 & Wi-Fi 6E KYOCERA AVX Stamped Metal Embedded Antenna.
 KYOCERA AVX produces a wide variety of standard and custom antennas to meet user needs.

Antenna Radiation Patterns

Typical Performance on 125 x 45 mm PCB
 Measured @ 6.425 GHz

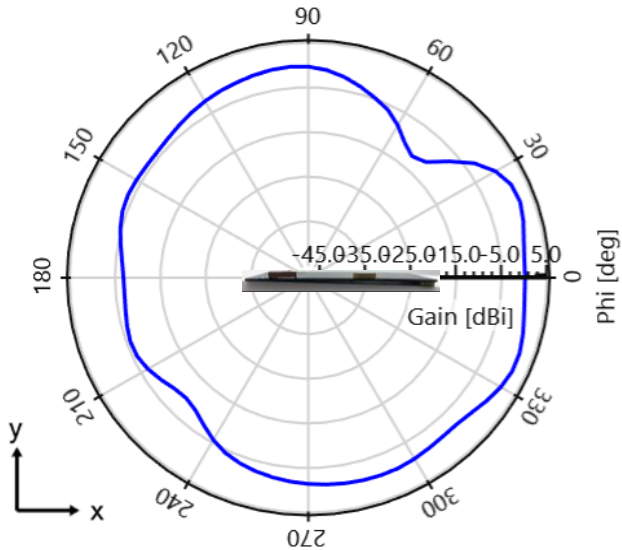
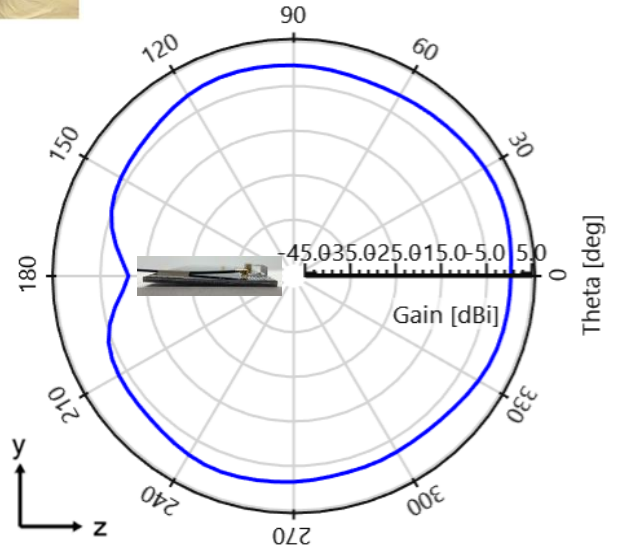
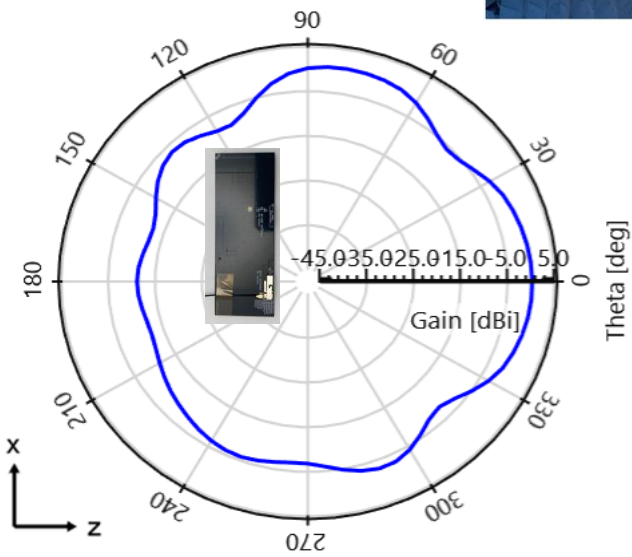
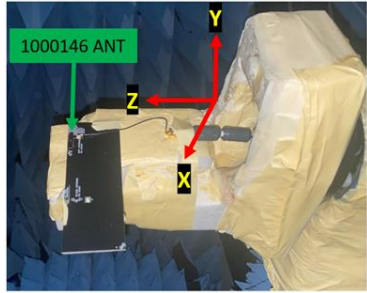

Wi-Fi 6 & Wi-Fi 6E KYOCERA AVX Stamped Metal Embedded Antenna.
KYOCERA AVX produces a wide variety of standard and custom antennas to meet user needs.

Antenna Layout (Minor Tuning Layout)

Typical layout dimensions (mm)

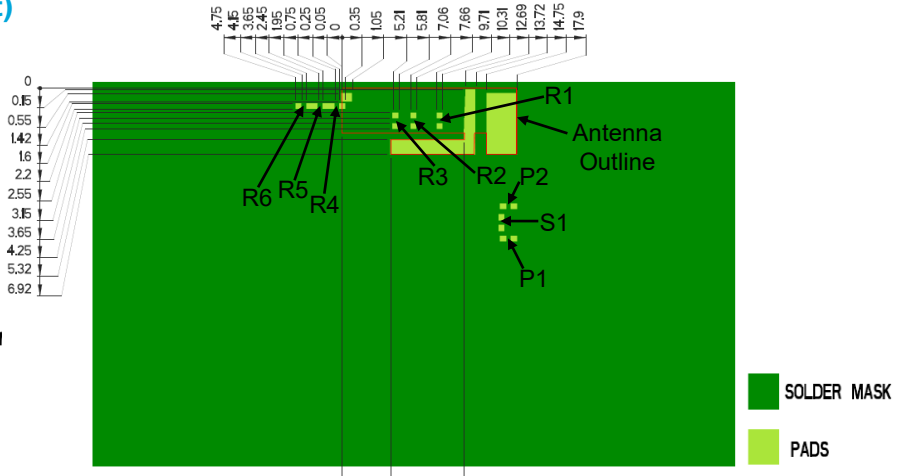
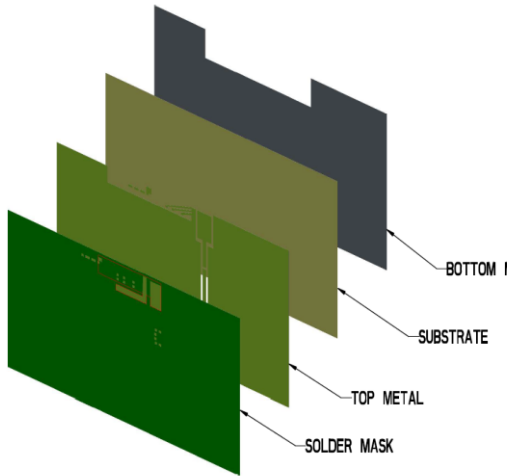

Note:
Layout has minor tuning capabilities to allow for small antenna footprint.

Pin Descriptions

Pin#	Description
1	Feed
2	Ground
3	Dummy Pad

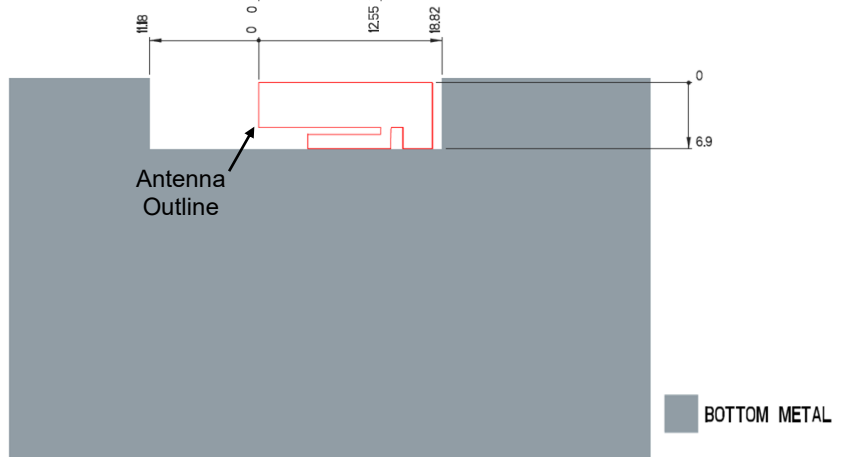
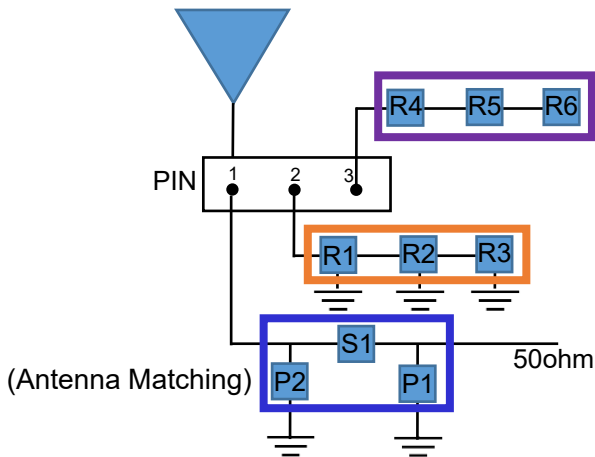
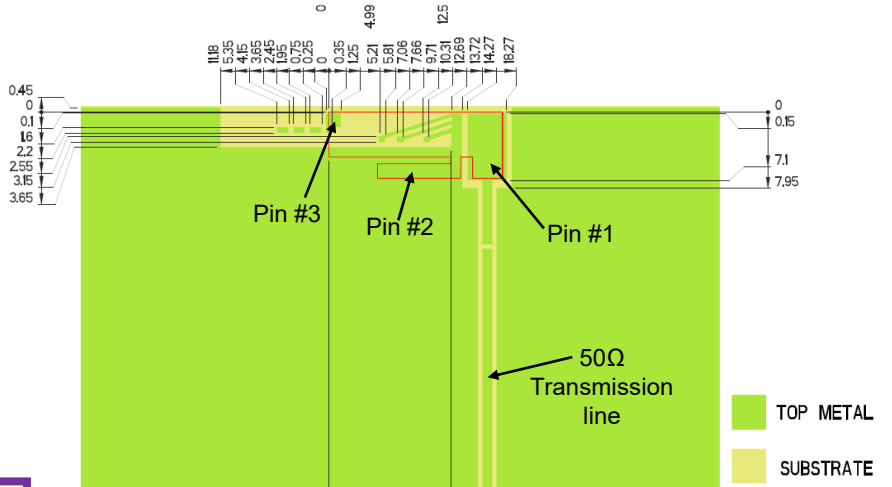

Antenna Matching & Tuning Component Values

	P1	S1	P2	R1 – R3	R4 – R6
Default Values	DNI	0Ω	DNI	DNI	DNI
Component Tolerance	N/A	N/A	N/A	N/A	N/A

Wi-Fi 6 & Wi-Fi 6E KYOCERA AVX Stamped Metal Embedded Antenna.
 KYOCERA AVX produces a wide variety of standard and custom antennas to meet user needs.

Antenna Layout (Major Tuning Layout)

Typical layout dimensions (mm)

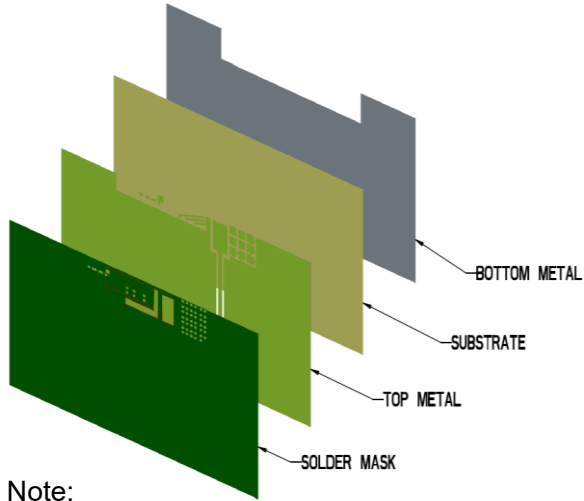

Note:
 Layout has Major tuning capabilities to allow for robust tuning after board spin, instructions on [Antenna Matching Structure](#) page.

Pin Descriptions

Pin#	Description
1	Feed
2	Ground
3	Dummy Pad

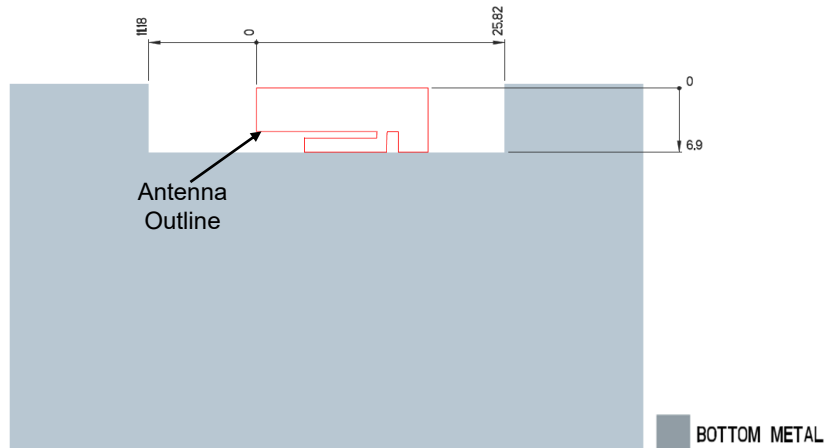
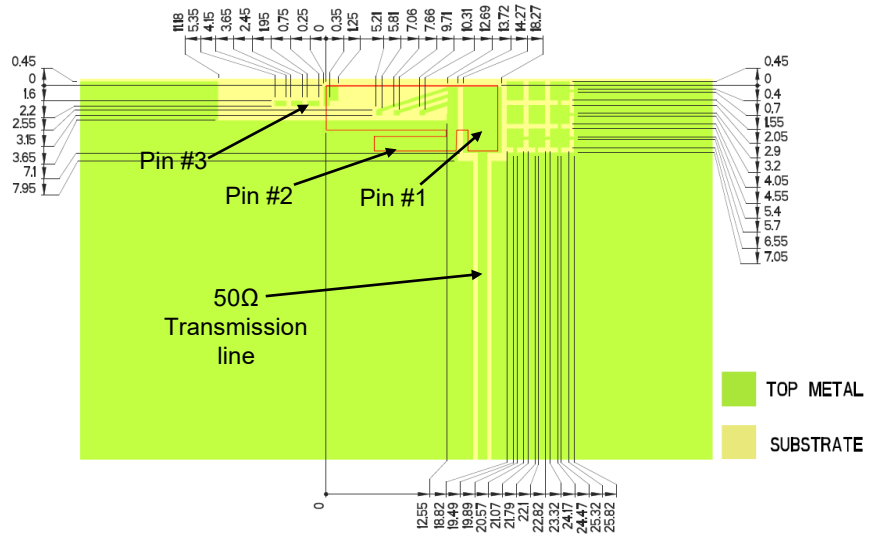
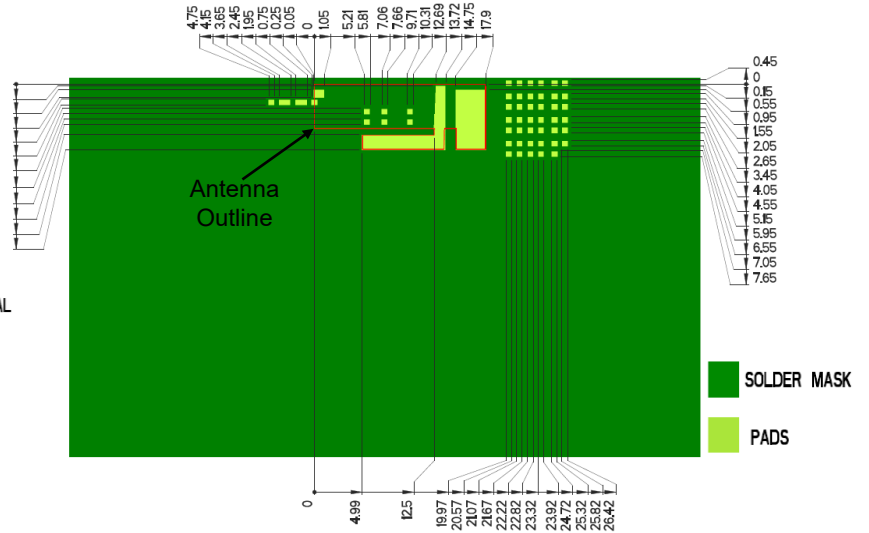

Wi-Fi 6 & Wi-Fi 6E KYOCERA AVX Stamped Metal Embedded Antenna.
KYOCERA AVX produces a wide variety of standard and custom antennas to meet user needs.

Antenna Matching Structure (Major Tuning Structure)

Typical matching values on 125 x 45 mm PCB

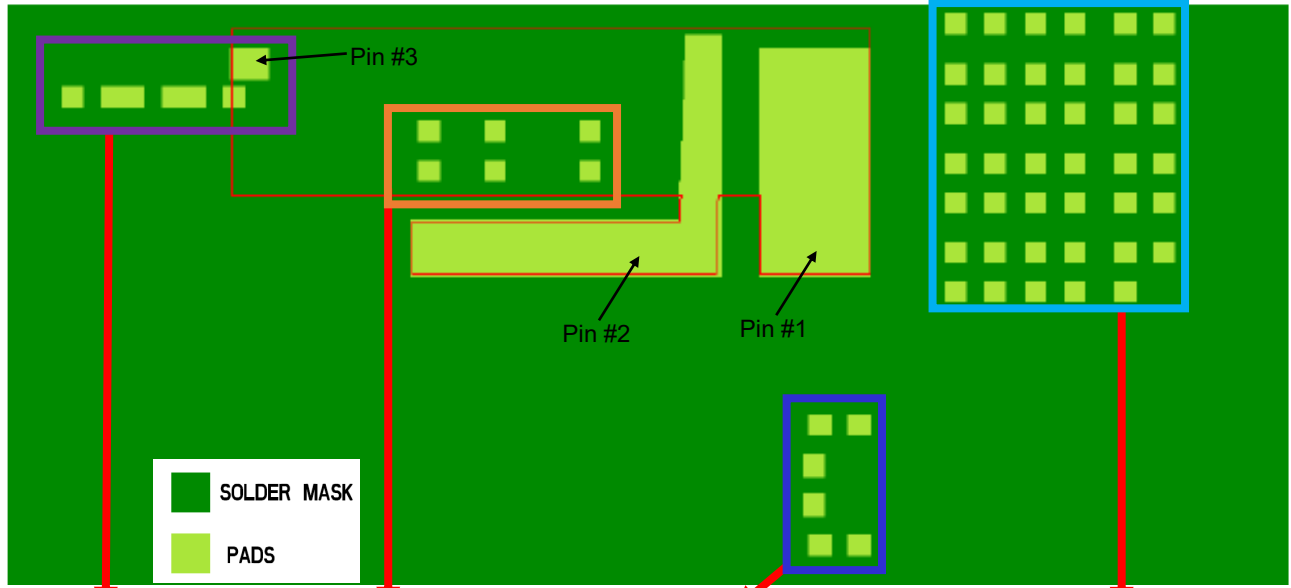

Low Band Tuning
(Add to Shift Low)



Low Band Tuning
(Add to Shift High)

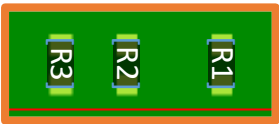

Antenna Matching

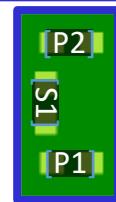

High Band Tuning
(Add to Shift High, DNI to Shift Low)

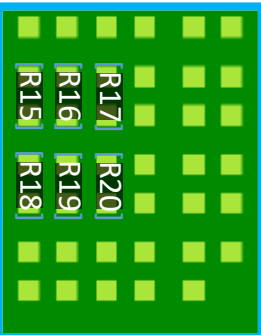
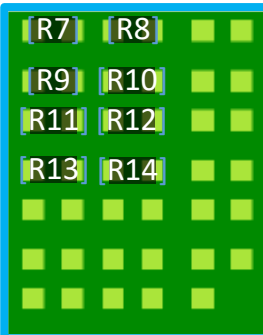

Pin Descriptions

Pin#	Description
1	Feed
2	Ground
3	Dummy Pad

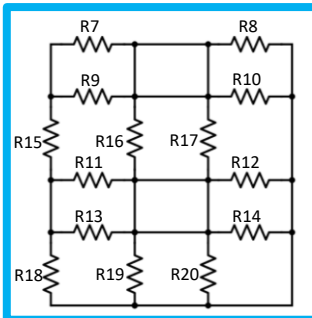
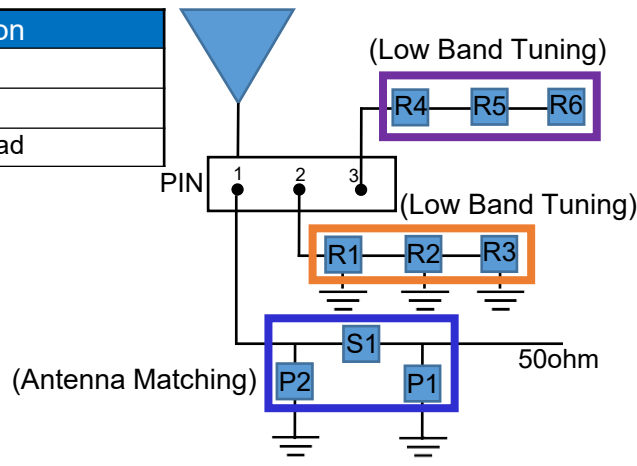

*Extend ground towards antenna feed with 0Ω component(s). R7- R20 can improve high band bandwidth/ performance with ground coupling.

	P1	S1	P2	R1 - R3	R4 - R6	R7 - R14	R15 - R20
Default Values	DNI	0Ω	DNI	DNI	DNI	DNI	DNI
Tolerance	N/A	N/A	N/A	N/A	N/A	N/A	N/A

Appendix 1 CBRS/n78 KYOCERA AVX Stamped Metal Embedded Antenna.
 KYOCERA AVX produces a wide variety of standard and custom antennas to meet user needs.

Appendix 1

Appendix 1 gives instructions on how to achieve CBRS/n78 performances through layout and impedance matching network.
(3.300 – 3.800 GHz)

Frequency (GHz)	3.300 – 3.800
Peak Gain	4.21 dBi
Average Efficiency	76%
VSWR Match	2.0:1 max
Feed Point Impedance	50 ohms unbalanced
Polarization	Linear
Power Handling	0.5 Watt CW

*Data shown above has Appendix 1 matching applied on (1000146-03) 100 x 50 mm pcb.

Appendix 1 CBRS/n78 KYOCERA AVX Stamped Metal Embedded Antenna.
KYOCERA AVX produces a wide variety of standard and custom antennas to meet user needs.

Appendix 1 (1000146-03)

Typical Performance on 100 x 50 mm PCB

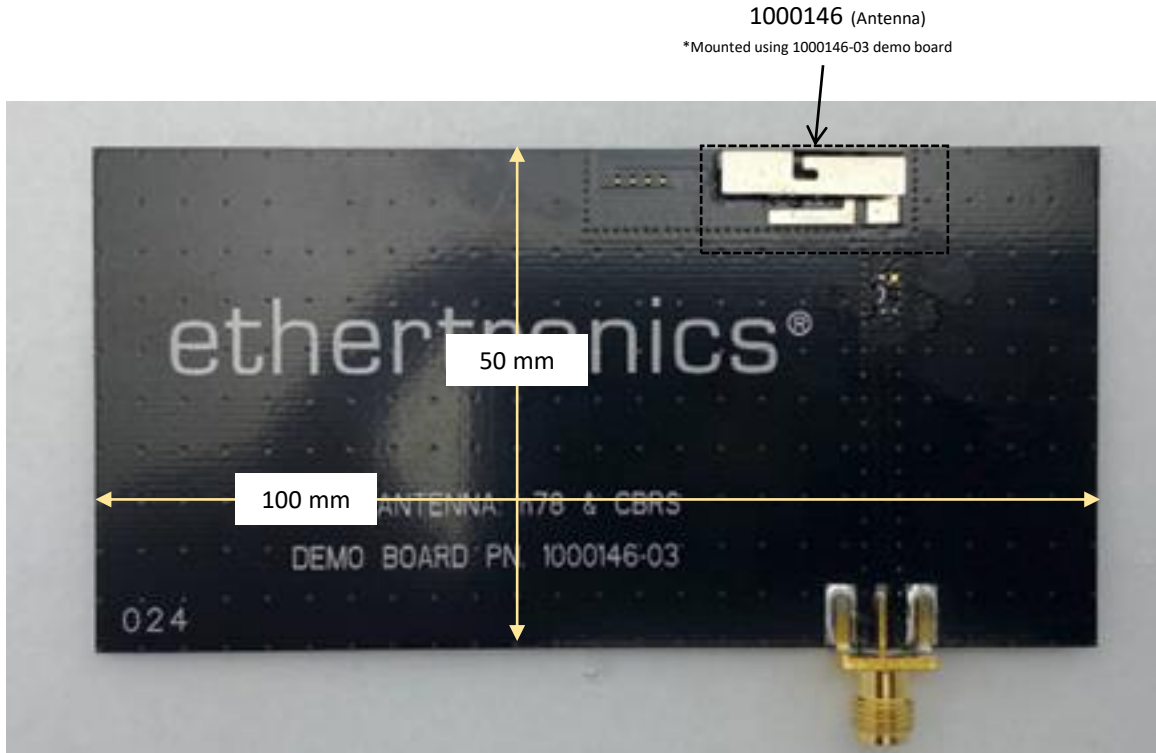

Appendix 1 CBRS/n78 KYOCERA AVX Stamped Metal Embedded Antenna.
 KYOCERA AVX produces a wide variety of standard and custom antennas to meet user needs.

Appendix 1 VSWR and Efficiency Plots

Typical Performance on 100 x 50 mm PCB



VSWR

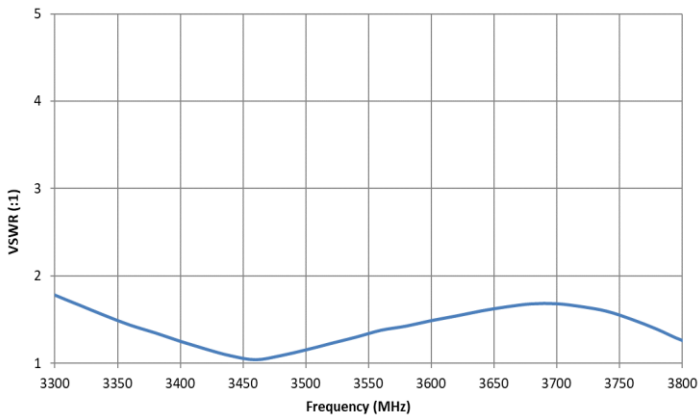

Efficiency

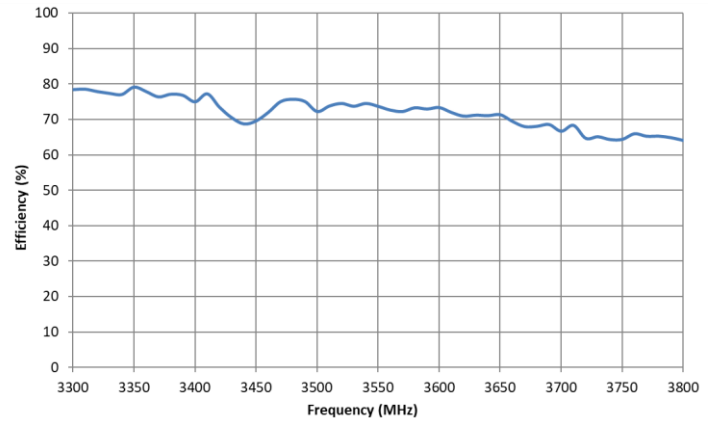

Peak Gain

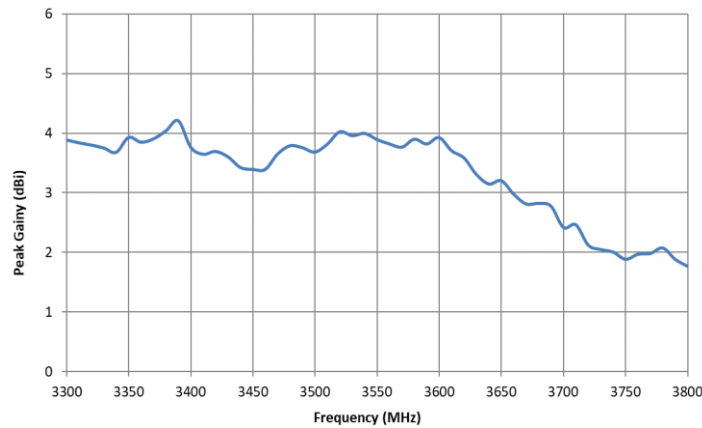

Appendix 1 CBRS/n78 KYOCERA AVX Stamped Metal Embedded Antenna.
 KYOCERA AVX produces a wide variety of standard and custom antennas to meet user needs.

Appendix 1 Antenna Radiation Patterns

Typical Performance on 100 x 50 mm PCB
 Measured @ 3500 MHz

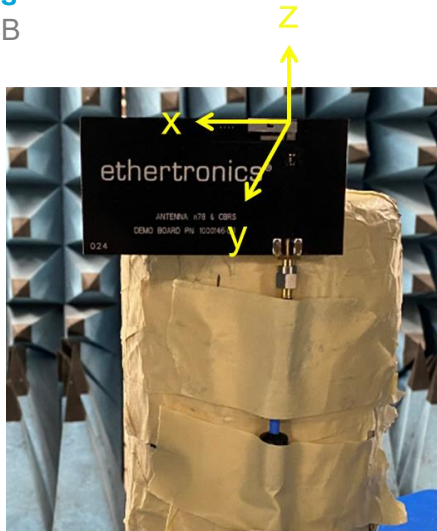

Measured at 3500 MHz

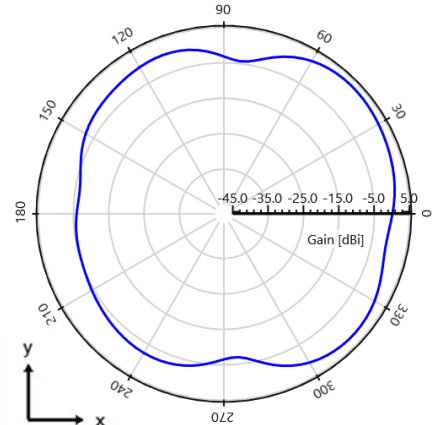
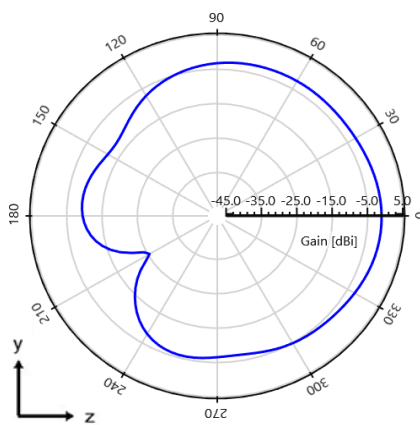
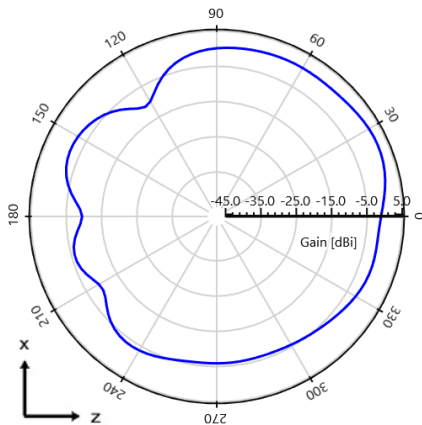

Appendix 1 CBRs/n78 KYOCERA AVX Stamped Metal Embedded Antenna.
KYOCERA AVX produces a wide variety of standard and custom antennas to meet user needs.

Antenna Layout (CBRS/n78 performances)

Typical layout dimensions (mm)

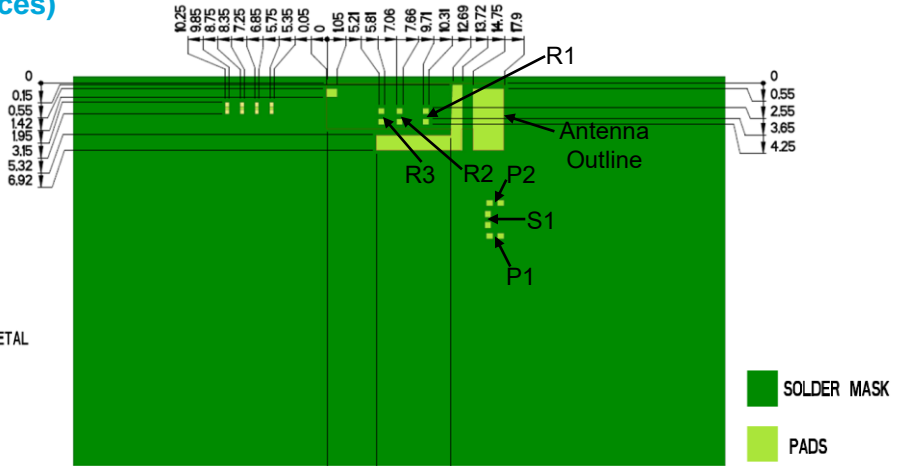
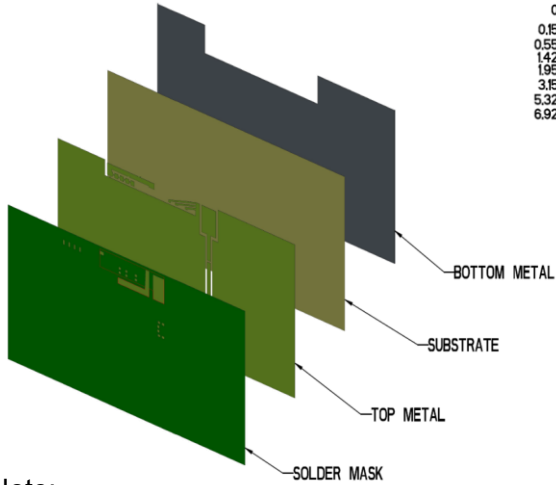

Note:
Layout has minor tuning capabilities to allow for small antenna footprint.

Pin Descriptions

Pin#	Description
1	Feed
2	Ground
3	Dummy Pad

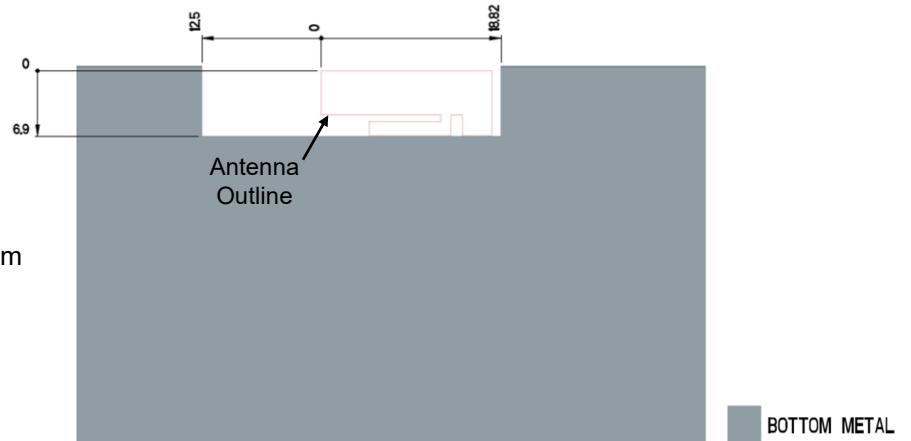
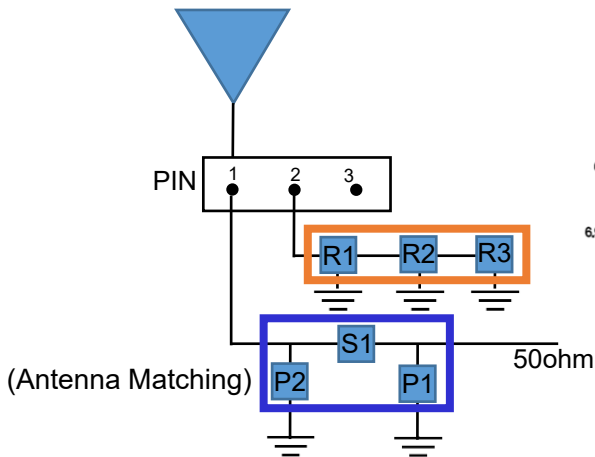
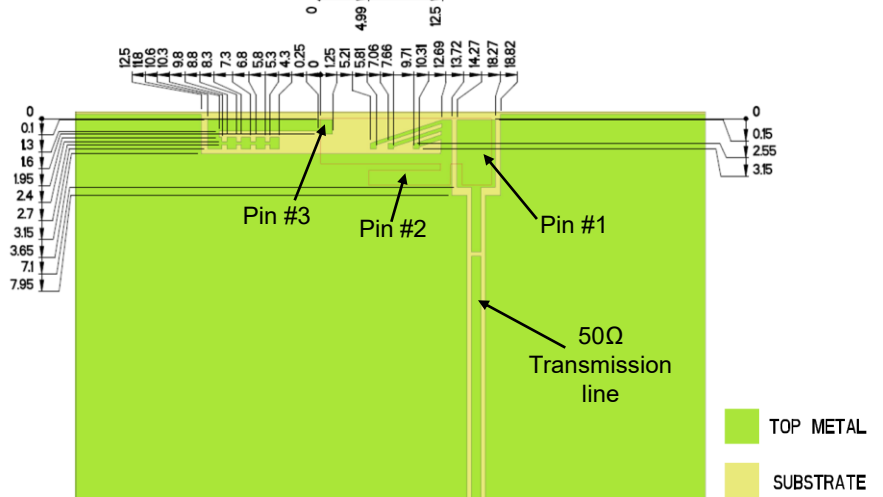

Antenna Matching & Tuning Component Values

	P1	S1	P2	R1 – R3
Default Values	DNI	1.5 nH	0.8 pF	DNI
Component Tolerance	N/A	(+/-0.05)	(+/-0.05)	N/A

Appendix 1 CBRS/n78 KYOCERA AVX Stamped Metal Embedded Antenna.
 KYOCERA AVX produces a wide variety of standard and custom antennas to meet user needs.

Antenna Matching Structure

Typical matching values on 100 x 50 mm PCB

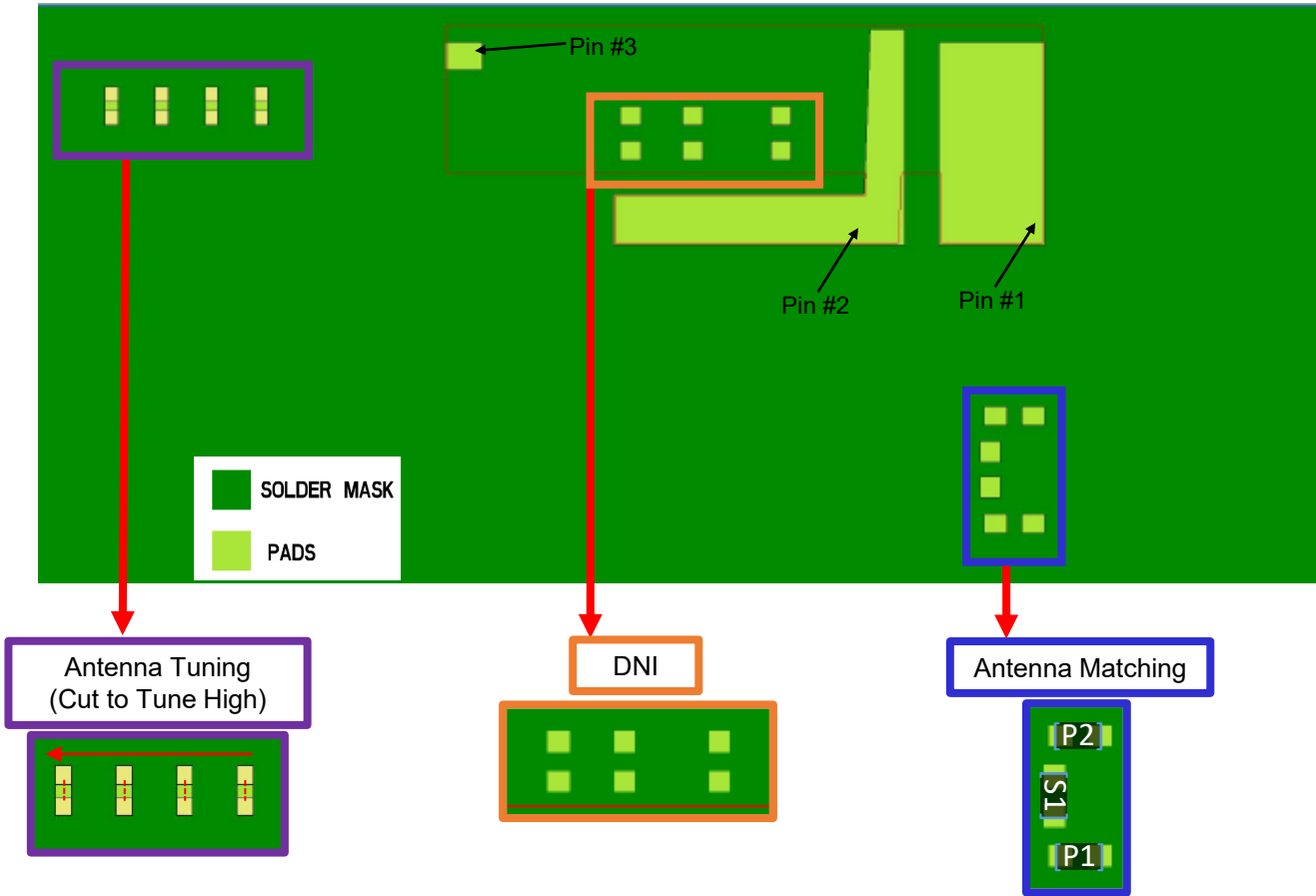

Pin Descriptions

Pin#	Description
1	Feed
2	Ground
3	Dummy Pad

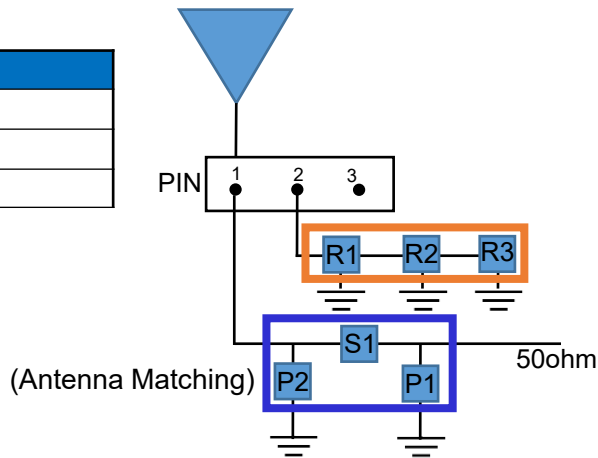

Antenna Matching & Tuning Component Values

	P1	S1	P2	R1 - R3
Default Values	DNI	1.5 nH	0.8 pF	DNI
Component Tolerance	N/A	(+/-0.05)	(+/-0.05)	N/A

X-ON Electronics

Largest Supplier of Electrical and Electronic Components

Click to view similar products for [Antenna Development Tools](#) category:

Click to view products by [Kyocera AVX](#) manufacturer:

Other Similar products are found below :

[PCSD.06.A](#) [1002427-02](#) [1004796-01](#) [YC0010AAEVB](#) [1001013-02](#) [1005454-01](#) [1004795-01](#) [1002436-01](#) [ACR1004A-EVB](#) [RAC00024-EVB](#) [RAC00245-EVB](#) [ACR1004GC-EVB](#) [W3012-K](#) [W3006-K](#) [SPD.25A](#) [74889100TB](#) [A10192-U1](#) [DTAD.01.A.50](#) [SR4C033-EVB-1](#) [AEK-LTE-CER](#) [IOT-K](#) [SR4W035-EVB-1](#) [W3010-K](#) [LORA-K](#) [ISM-K](#) [REFLECTOR-EVB-1](#) [ACAG0201-2450-EVB](#) [ACAG0301-15752450-EVB](#) [ACAG0301-1575-EVB](#) [ACAG0301-24505500-EVB](#) [ACAG0301-5500-EVB](#) [ACAG0801-2450-EVB](#) [ACAG1204-433-EVB](#) [ACAG1204-868-EVB](#) [ACAG1204-915-EVB](#) [ACAR0301-SW2-EVB](#) [ACAR3005-C2WB-EVB](#) [ACAR3005-S824-EVB](#) [ACAR3705-S698-EVB](#) [ACAR4008-S698-EVB](#) [ACR0301U-EVB](#) [ACR1504I3-EVB-A](#) [ACR1504I3-EVB-S](#) [ACR2005I4-EVB](#) [ACR4006X-EVB](#) [PRO-EB-450](#) [PRO-EB-453](#) [PRO-EB-472](#) [PRO-EB-476](#) [PRO-EB-550](#)