

Part No. 1001013

Wi-Fi / BT or DECT NR+ SMD On/Off Ground Antenna

2400 - 2485 MHz or 1880 - 1930 MHz

Supports: Wi-Fi applications, DECT NR+, Bluetooth, Zigbee, WLAN



*DECT NR+ layout offered in Appendix 1

FR4 Wi-Fi / Bluetooth Antenna or DECT NR+

2400 - 2485 MHz

1880 - 1930 MHz

KEY BENEFITS

Stay-in-Tune

IMD antenna technology provides superior RF field containment, resulting in less interaction with surrounding components.

Quicker Time-to-Market

By optimizing antenna size, performance and emissions, customer and regulatory specifications are more easily met.

Environmental Compliance

Products are the latest RoHS version compliant.

APPLICATIONS

- Embedded design
- Cellular, Headsets, Tablets
- Gateway, Access Point
- Handheld
- Telematics
- Tracking
- Healthcare (FDA Class I)
- M2M, Industrial devices
- Smart Grid
- OBD-II

KYOCERA AVX antennas deliver on the key needs of device designers for higher functionality and performance in smaller/thinner designs.

Real-World Performance and Implementation

Antennas may look alike on the outside, but the important difference is inside. Other antennas may contain simple PIFA or monopole designs that interact with their surroundings, complicating layout or changing performance with use position. KYOCERA AVX antennas utilize patented IMD technology to deliver a unique size and performance combination.

Greater Flexibility

KYOCERA AVX IMD technology enables the advance antenna design that delivers superior performance in reception critical applications. 1001013 is capable of being used in off-ground and on-ground (over metal) environments. The 1001013 also covers DECT NR+ technology.

Layouts: 1001013-02: Single Band 2.4 GHz layout

1001013-04: DECT NR+ 1.8 - 1.93 GHz layout (Appendix 1)

Electrical Specifications

Typical Characteristics, on 50 x 70 mm PCB

Frequency	2400 - 2485 MHz		1880 - 1930 MHz
Mounting	Off Ground	On Ground (Over Metal)	Off Ground
VSWR Match	1.5:1 max	1.8:1 max	Refer to Appendix 1
Average Efficiency	76%	48%	
Peak Gain	2.6 dBi	0.7 dBi	
Feed Point Impedance	50 ohms unbalanced		
Polarization	Linear		
Power Handling	2 Watt CW		

Mechanical Specifications & Ordering Part Number

Ordering Part Number	1001013
Size (mm)	15.0 x 3.2 x 3.3
Mounting	Surface mounted to the PCB
Weight (grams)	0.2
Packaging	Tape & Reel
Demo Board	1001013-02 (2.4 - 2.485 GHz) 1001013-04 (DECT NR+ 1.88 - 1.93 GHz)
Operating Temperature	-40°C to +85°C

Wi-Fi / BT KYOCERA AVX Embedded Antenna Specifications.
 KYOCERA AVX produces a wide variety of standard and custom antennas to meet user needs.

Antenna Dimensions

Typical antenna dimensions (mm)

Part Number	A (mm)	B (mm)	C (mm)
1001013	15.0 ± 0.2	3.2 ± 0.2	3.3 ± 0.3

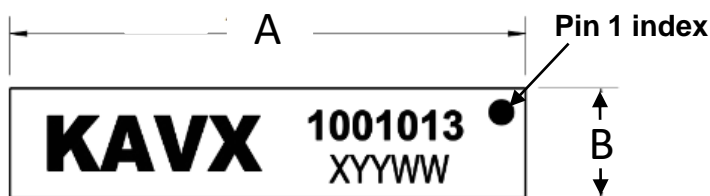
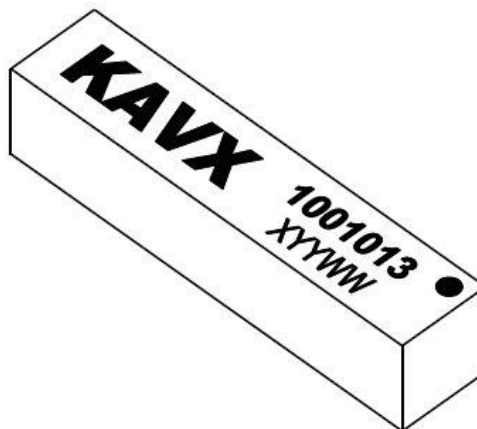

TOP VIEW



FRONT VIEW

Pin	Description
1	Feed
2	Dummy Pad
3	Dummy Pad

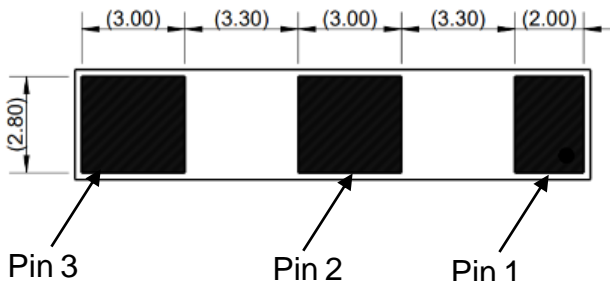

BOTTOM VIEW

Wi-Fi / BT KYOCERA AVX Embedded Antenna Specifications.
 KYOCERA AVX produces a wide variety of standard and custom antennas to meet user needs.

VSWR and Efficiency Plots (Off-Ground)

Typical performance on 50 x 70 mm PCB

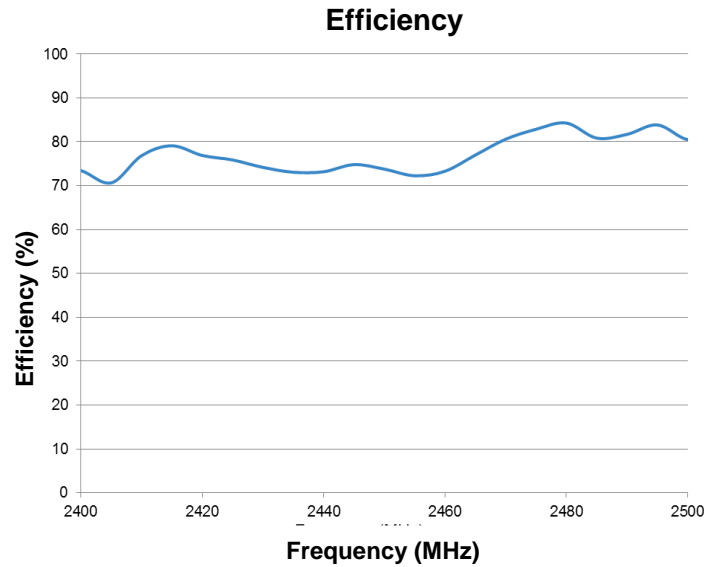
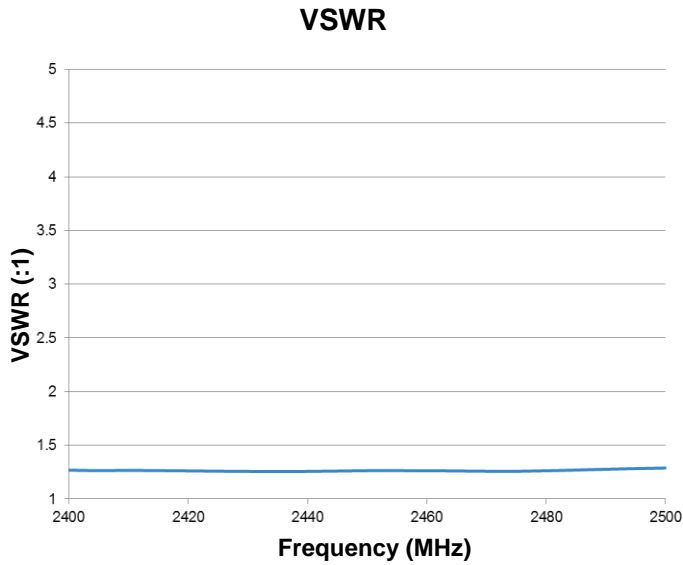

Antenna Radiation Patterns (Off-Ground)

Typical performance on 50 x 70 mm PCB

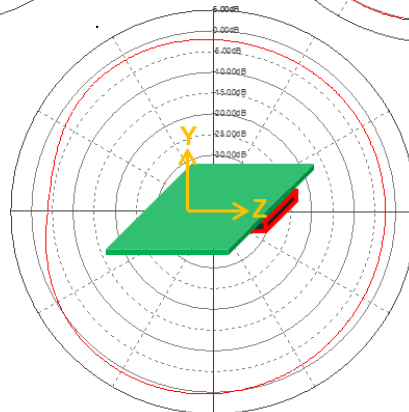
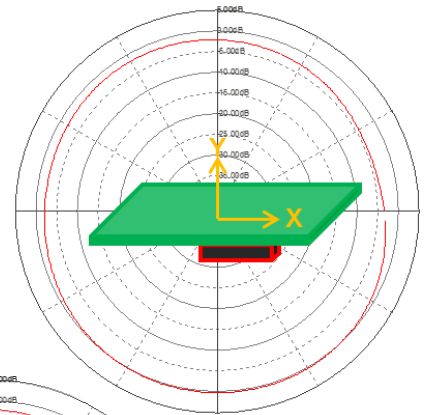
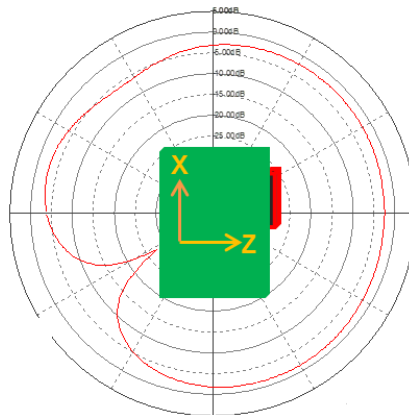
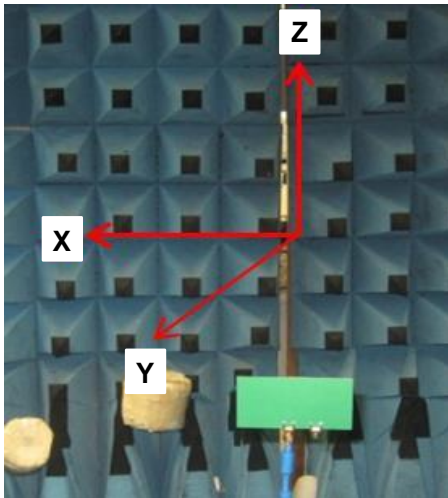

Wi-Fi / BT KYOCERA AVX Embedded Antenna Specifications.
KYOCERA AVX produces a wide variety of standard and custom antennas to meet user needs.

Antenna Layout (Off-Ground)

Typical layout dimensions (mm)

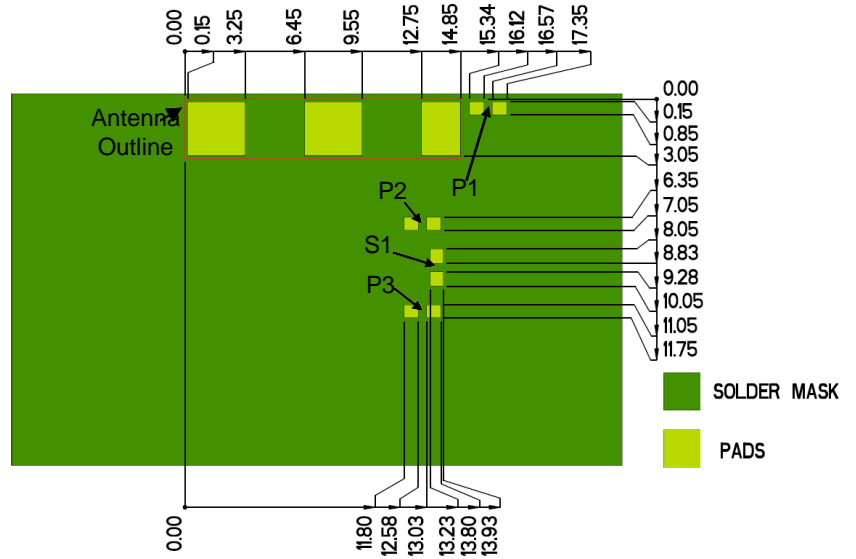
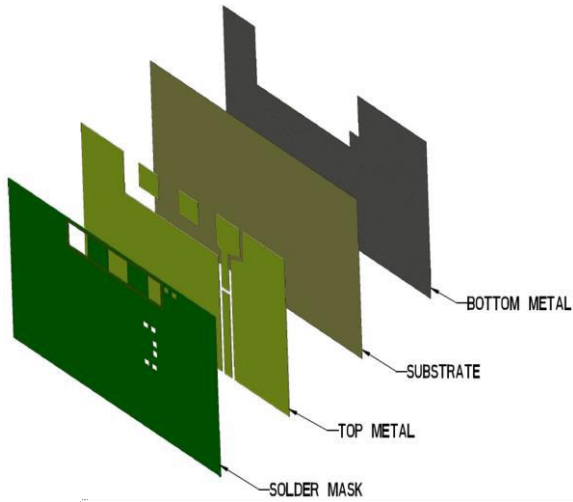

* VIAS: Diam. 0.2mm, (no vias on transmission lines).
Via holes must be covered by solder mask

Pin Descriptions

Pin#	Description
1	Feed
2	Dummy Pad
3	Dummy Pad

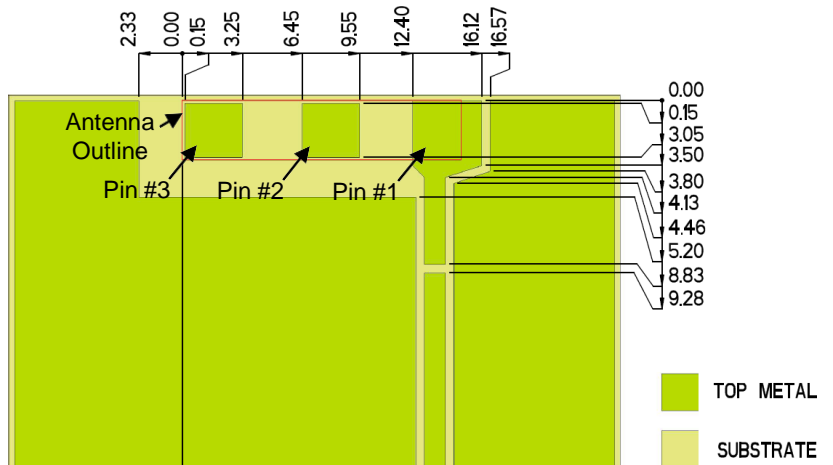

Matching Pi Network (Demo Board)

Component	Value	Tolerance
P1	0Ω	N/A
S1	0Ω	N/A
P2	0.4pF	±0.05pF
P3	DNI	N/A

*Actual matching values depend on customer design

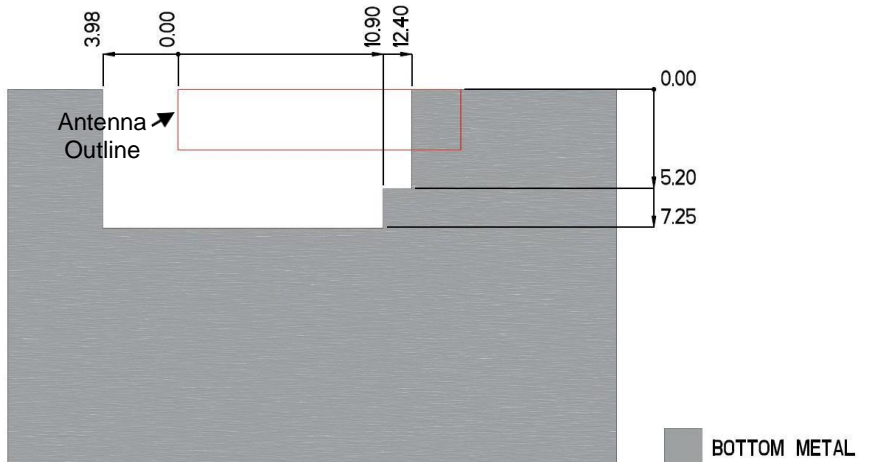
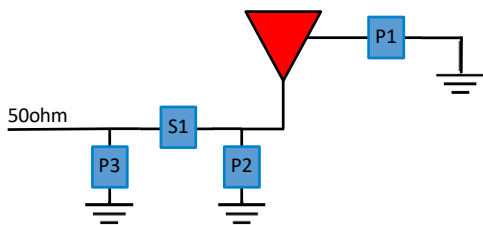

Wi-Fi / BT KYOCERA AVX Embedded Antenna Specifications.
 KYOCERA AVX produces a wide variety of standard and custom antennas to meet user needs.

VSWR and Efficiency Plots (On-Ground)

Typical performance on 50 x 70 mm PCB

VSWR

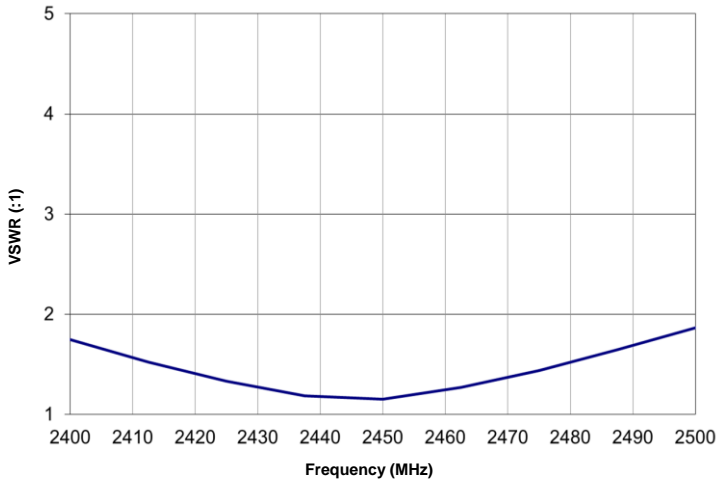

Efficiency

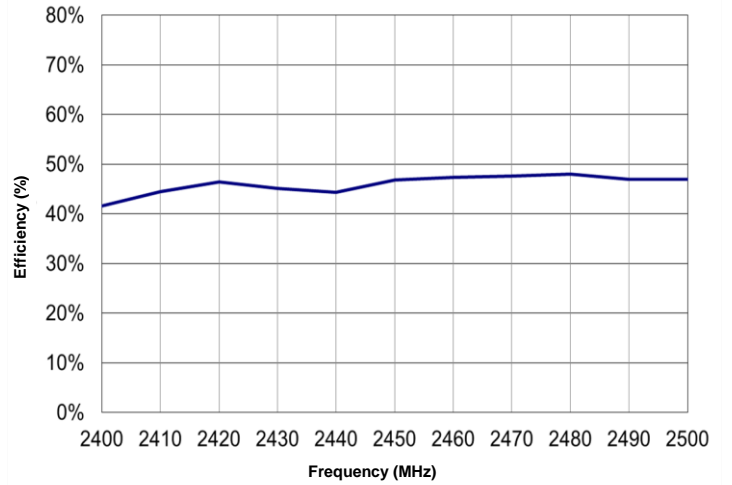

Antenna Radiation Patterns (On-Ground)

Typical performance on 50 x 70 mm PCB

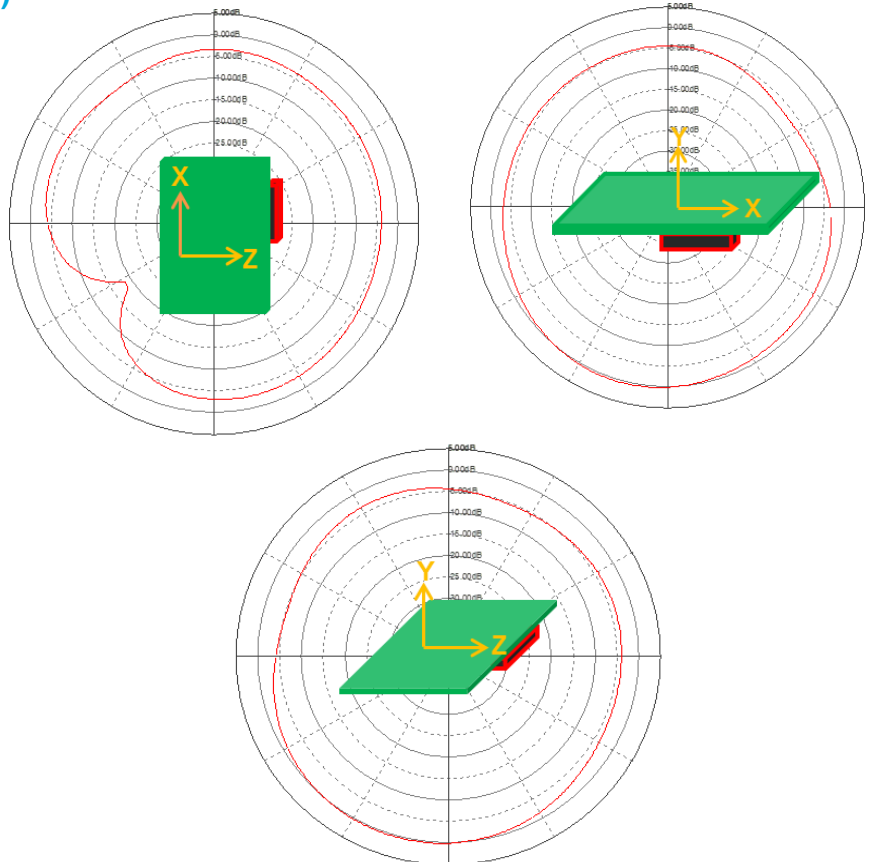
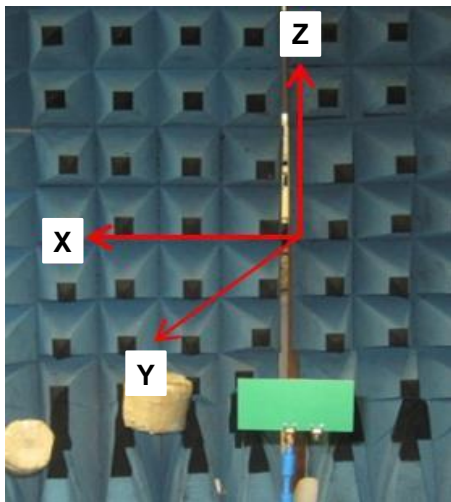

Wi-Fi / BT KYOCERA AVX Embedded Antenna Specifications.
KYOCERA AVX produces a wide variety of standard and custom antennas to meet user needs.

Antenna Layout (On-Ground)

Typical layout dimensions (mm)

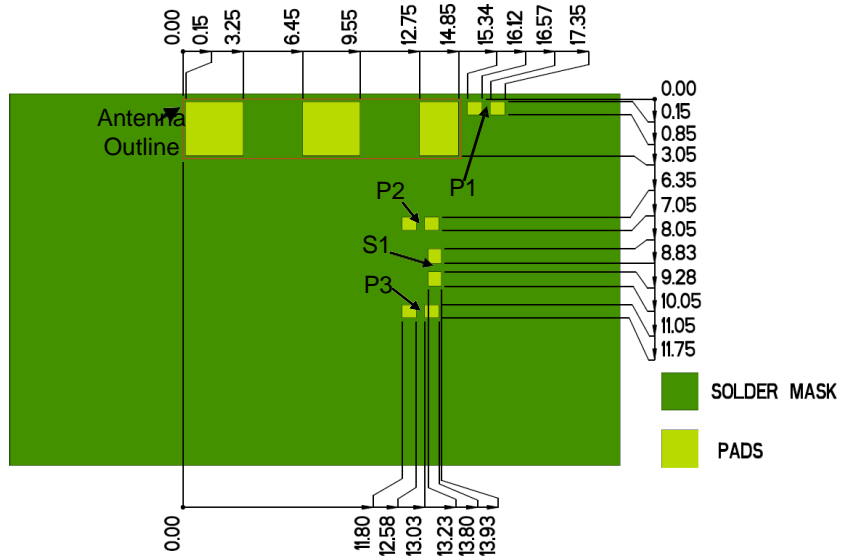
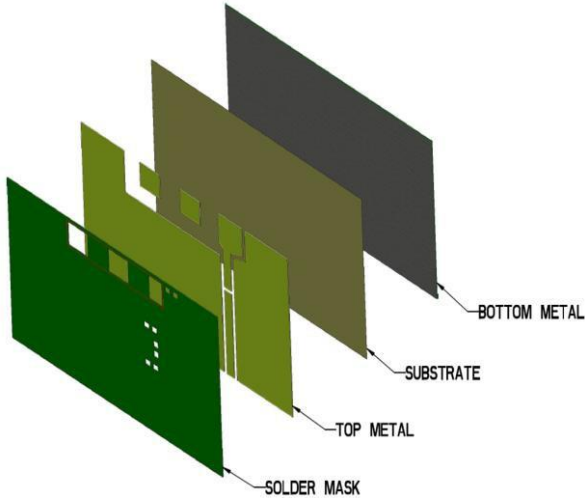

* VIAS: Diam. 0.2mm, (no vias on transmission lines).
Via holes must be covered by solder mask

Pin Descriptions

Pin#	Description
1	Feed
2	Dummy Pad
3	Dummy Pad

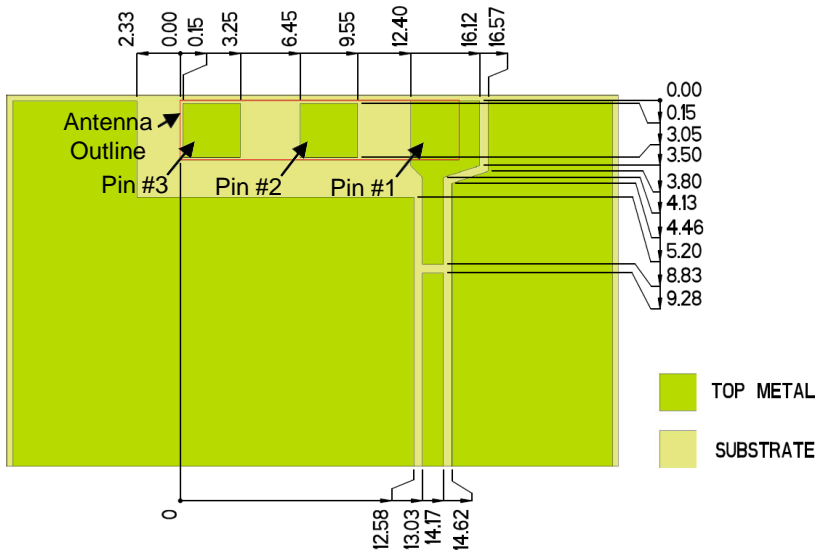

Matching Pi Network (Demo Board)

Component	Value	Tolerance
P1	0Ω	N/A
S1	0Ω	N/A
P2	DNI	N/A
P3	DNI	N/A

*Actual matching values depend on customer design

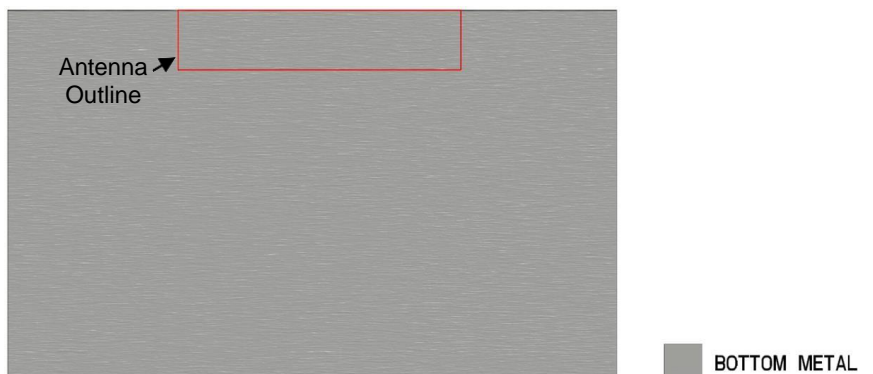
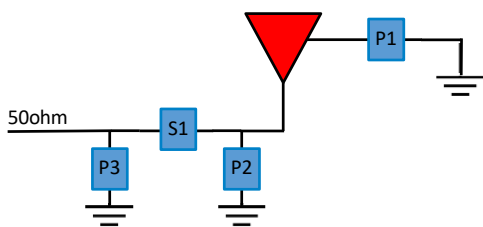

Wi-Fi / BT KYOCERA AVX Embedded Antenna Specifications.
 KYOCERA AVX produces a wide variety of standard and custom antennas to meet user needs.

Antenna Demo Board

1001013-02 Off-Ground

Part Number	A (mm)	B (mm)	C (mm)
1001013-02	72.0	50.0	15.0

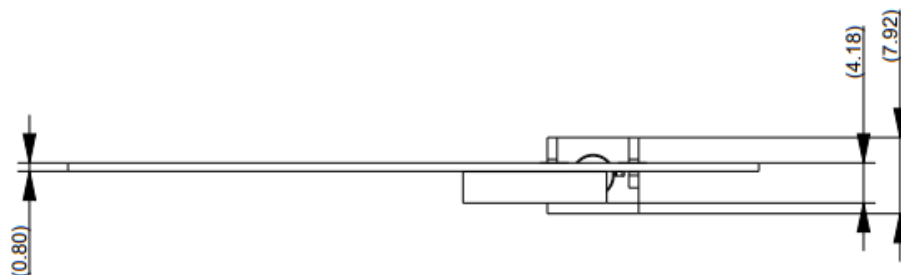
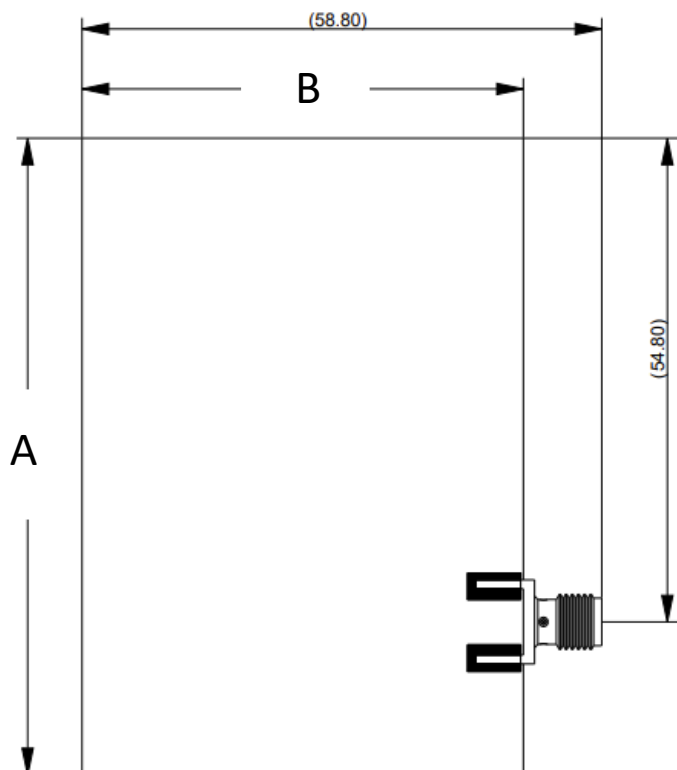
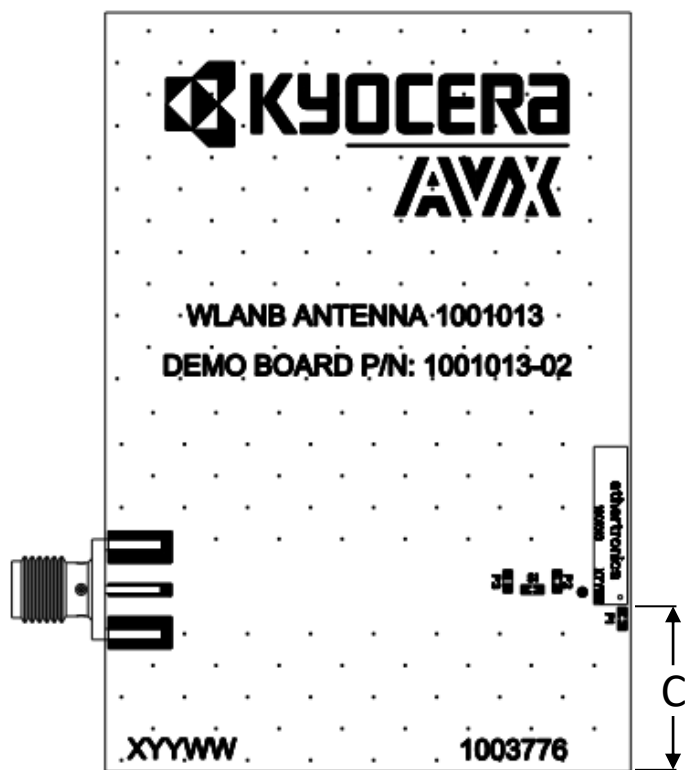

DECT NR+ KYOCERA AVX Embedded Antenna Specifications.
 KYOCERA AVX produces a wide variety of standard and custom antennas to meet user needs.

Appendix 1

Appendix 1 gives instructions on how to achieve DECT NR+ performances through layout and impedance tuning network. of DECT NR+ (1880 - 1930 MHz)

Electrical Specifications

Frequency (MHz)	1880 – 1930 MHz
Peak Gain	1.6 dBi
Average Efficiency	80%
VSWR Match	< 1.5:1
Polarization	Linear
Power Handling	2 Watt CW
Feed Point Impedance	50 Ω unbalanced
Radiation Pattern	Omnidirectional

*Data shown in Appendix 1 matching applied on 53 x 53 mm PCB.



DECT NR+ KYOCERA AVX Embedded Antenna Specifications.
KYOCERA AVX produces a wide variety of standard and custom antennas to meet user needs.

Test Environment Setup

Typical performance on 53 x 53 mm PCB

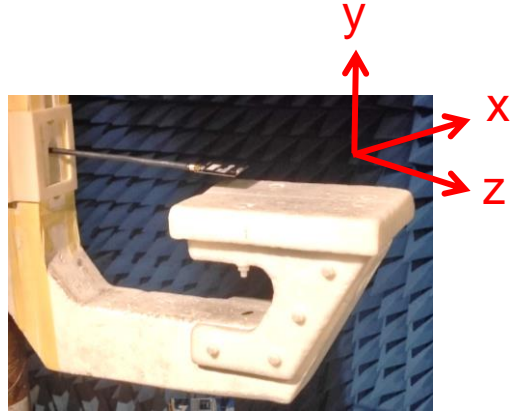

VSWR, Efficiency and Gain Plots

Typical performance on 53 x 53 mm PCB

Return Loss (1880 – 1930 MHz)

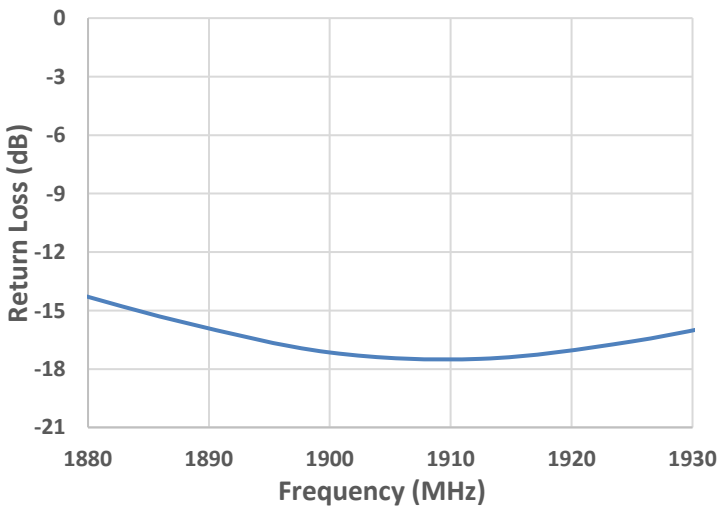

Efficiency (1880 – 1930 MHz)

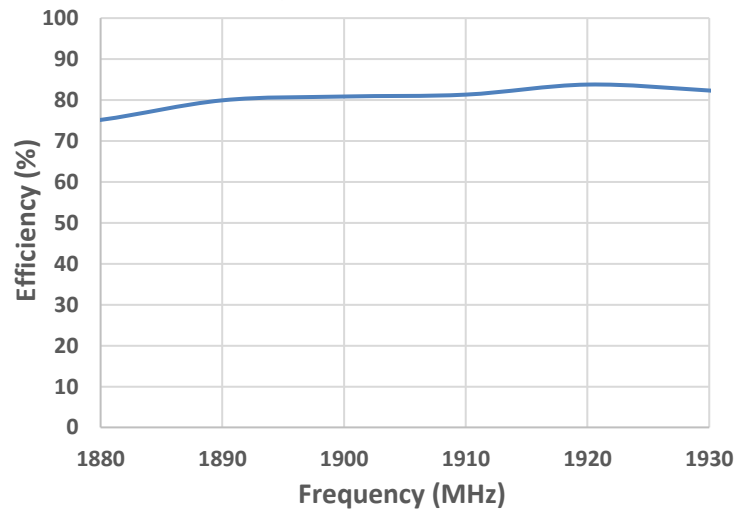

Gain (1880 – 1930 MHz)

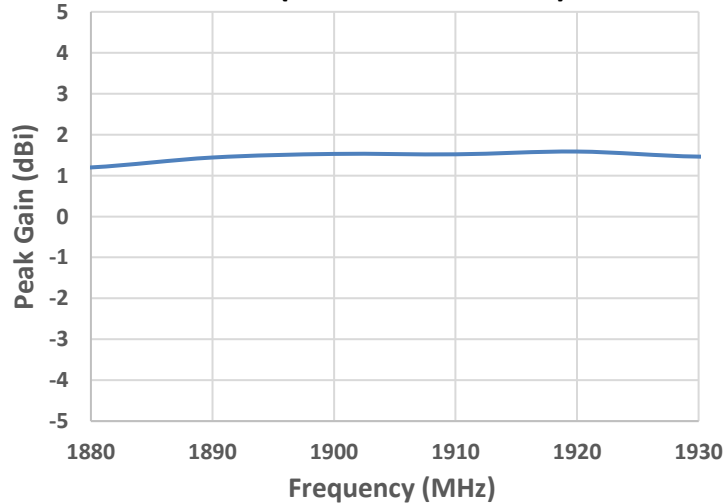

DECT NR+ KYOCERA AVX Embedded Antenna Specifications.
 KYOCERA AVX produces a wide variety of standard and custom antennas to meet user needs.

Test Environment Setup

Typical performance on 53 x 53 mm PCB

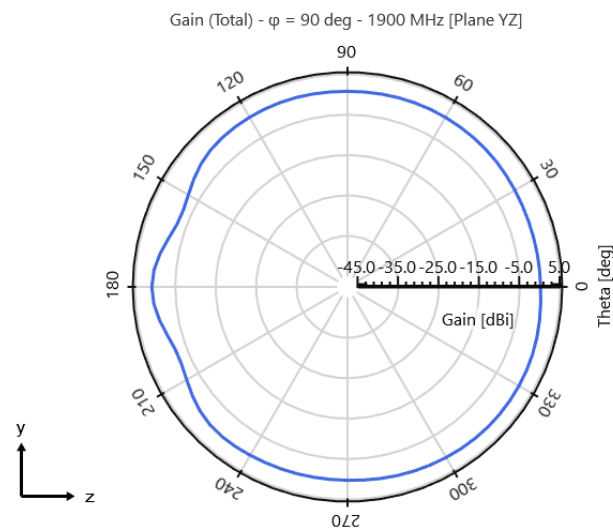
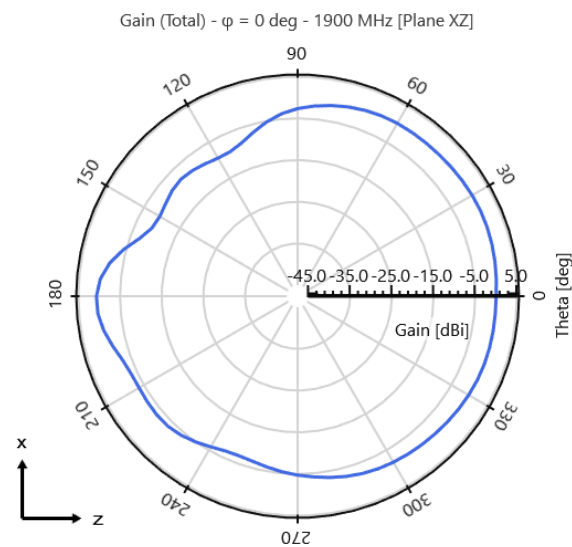
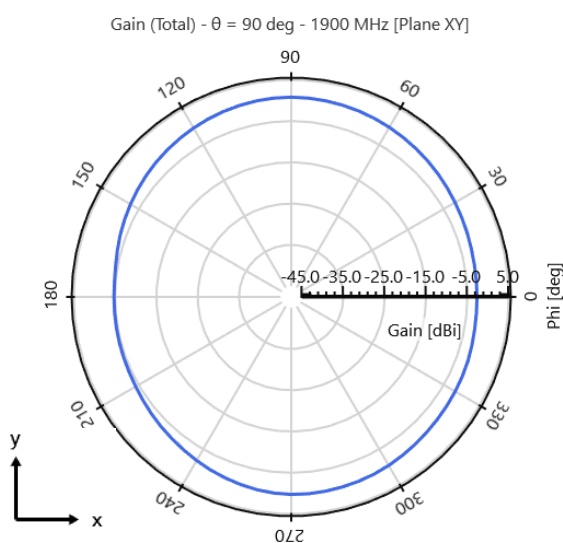

DECT NR+ KYOCERA AVX Embedded Antenna Specifications.
 KYOCERA AVX produces a wide variety of standard and custom antennas to meet user needs.

Antenna Layout (Off-Ground)

Typical layout dimensions (mm)

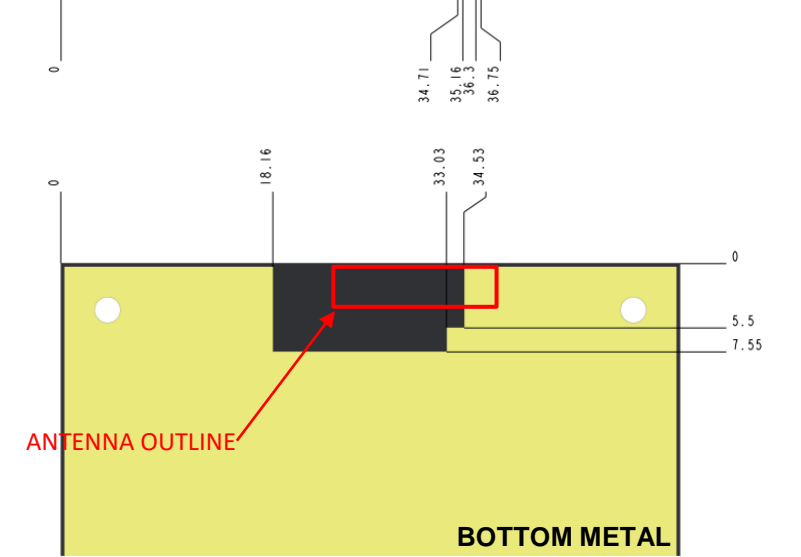
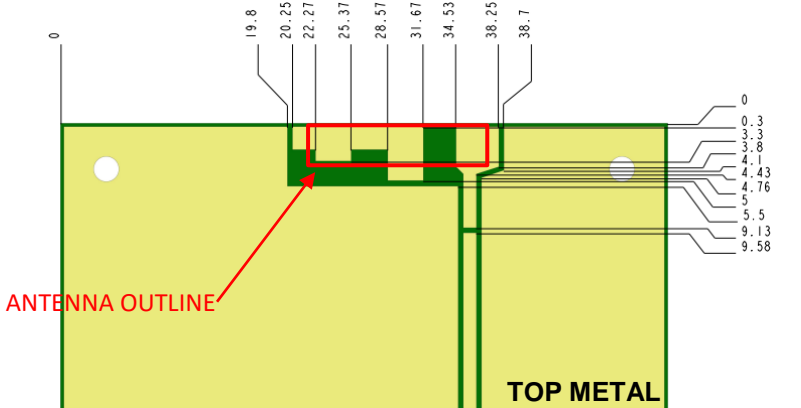
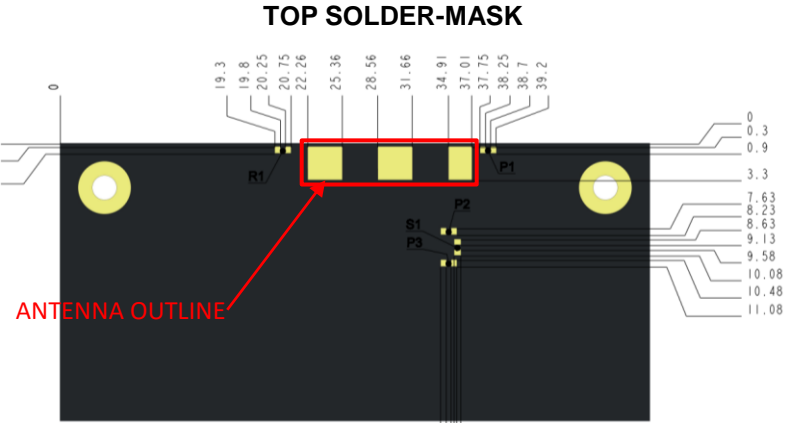
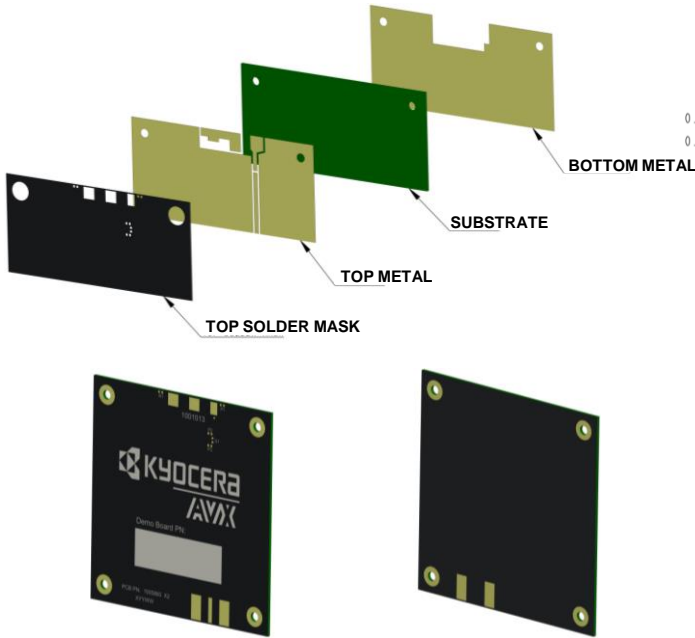

* VIAS: Diam. 0.2mm, (no vias on transmission lines).
 Via holes must be covered by solder mask

Pin Descriptions

Pin#	Description
1	Feed
2	Dummy Pad
3	Dummy Pad

Matching Pi Network (Demo Board)

Component	Value	Tolerance
R1	1.8pF	±0.05pF
P1	N/A	N/A
S1	0Ω	N/A
P2	N/A	N/A
P3	N/A	N/A

*Actual matching values depend on customer design

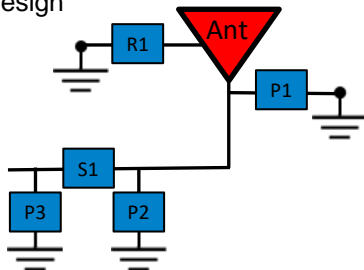

DECT NR+ KYOCERA AVX Embedded Antenna Specifications.
 KYOCERA AVX produces a wide variety of standard and custom antennas to meet user needs.

Antenna Demo Board

Part Number	A (mm)	B (mm)	C (mm)
1001013-04	53.0	53.0	15.9

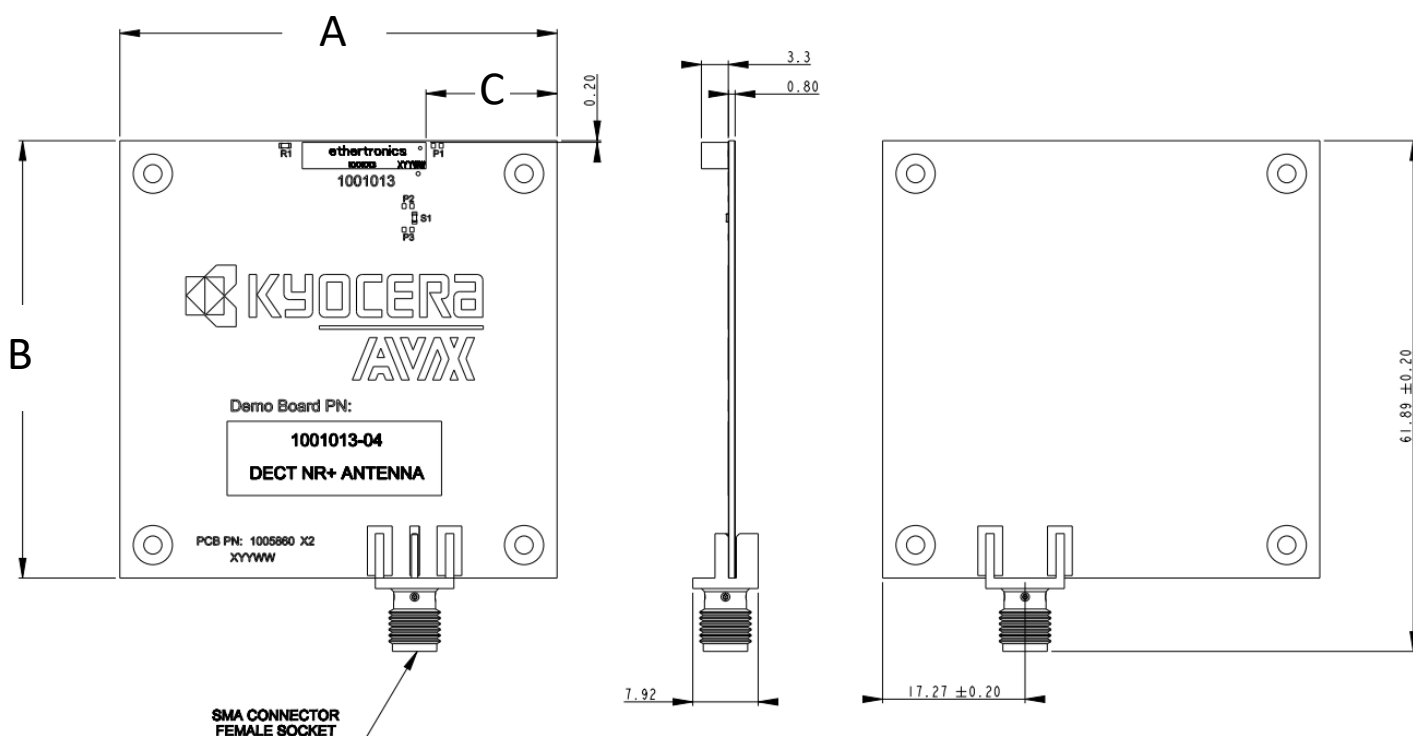

X-ON Electronics

Largest Supplier of Electrical and Electronic Components

Click to view similar products for [Antenna Development Tools](#) category:

Click to view products by [Kyocera AVX](#) manufacturer:

Other Similar products are found below :

[PCSD.06.A](#) [1002427-02](#) [1004796-01](#) [YC0010AAEVB](#) [1001013-02](#) [1005454-01](#) [1004795-01](#) [1002436-01](#) [ACR1004A-EVB](#) [RAC00024-EVB](#) [RAC00245-EVB](#) [ACR1004GC-EVB](#) [W3012-K](#) [W3006-K](#) [SPD.25A](#) [74889100TB](#) [A10192-U1](#) [DTAD.01.A.50](#) [SR4C033-EVB-1](#) [AEK-LTE-CER](#) [IOT-K](#) [SR4W035-EVB-1](#) [W3010-K](#) [LORA-K](#) [ISM-K](#) [REFLECTOR-EVB-1](#) [ACAG0201-2450-EVB](#) [ACAG0301-15752450-EVB](#) [ACAG0301-1575-EVB](#) [ACAG0301-24505500-EVB](#) [ACAG0301-5500-EVB](#) [ACAG0801-2450-EVB](#) [ACAG1204-433-EVB](#) [ACAG1204-868-EVB](#) [ACAG1204-915-EVB](#) [ACAR0301-SW2-EVB](#) [ACAR3005-C2WB-EVB](#) [ACAR3005-S824-EVB](#) [ACAR3705-S698-EVB](#) [ACAR4008-S698-EVB](#) [ACR0301U-EVB](#) [ACR1504I3-EVB-A](#) [ACR1504I3-EVB-S](#) [ACR2005I4-EVB](#) [ACR4006X-EVB](#) [PRO-EB-450](#) [PRO-EB-453](#) [PRO-EB-472](#) [PRO-EB-476](#) [PRO-EB-550](#)