



Part No. 1001312

Wi-Fi / BT / Zigbee or UWB Ceramic Antenna

2.4 GHz or 6.0 – 8.5 GHz

Supports: Wi-Fi applications, Agriculture, Automotive, Bluetooth, Zigbee, WLAN, Smart Home, Healthcare, Digital Signage, UWB

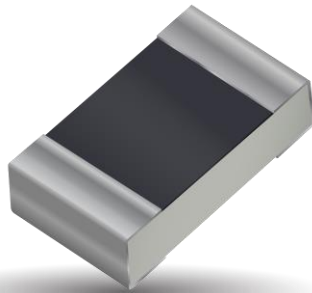

*UWB layout offered in Appendix 1

Ceramic Wi-Fi or UWB Ceramic Antenna

2400 – 2485 MHz;
6.0 – 8.5 GHz

KEY BENEFITS

Stay-in-Tune

IMD antenna technology provides superior RF field containment, resulting in less interaction with surrounding components.

Quicker Time-to-Market

By optimizing antenna size, performance and emissions, customer and regulatory specifications are more easily met.

Reliability

Products are the latest RoHS version compliant.

APPLICATIONS

- Embedded design
- Cellular, Headsets, Tablets
- Gateway, Access Point
- Handheld
- Telematics
- Tracking
- Healthcare
- M2M, Industrial devices
- Smart Grid
- OBD-II
- UWB

Ethertronics' series of ceramic Isolated Magnetic Dipole™ (IMD) antennas deliver on the key needs of device designers for higher functionality and performance in smaller/thinner designs.

Real-World Performance and Implementation

Ceramic antennas may look alike on the outside, but the important difference is inside. Other antennas may contain simple PIFA or monopole designs that interact with their surroundings, complicating layout or changing performance with use position. Ethertronics' antennas utilize patented IMD technology to deliver a unique size and performance combination.

Layouts:

1001312-01: Single Band 2.4 GHz layout

1001312-04: UWB 6.0 - 8.5 GHz layout (Appendix 1)

Electrical Specifications

Typical performance on 55 x 25 mm PCB

Frequency	2400 – 2485 MHz	6.0 – 8.5 GHz
Peak Gain	1.88 dBi	Refer to Appendix 1
Average Efficiency	62%	
VSWR Match	1.8:1 max	
Feed Point Impedance	50 ohms unbalanced	
Polarization	Linear	
Power Handling	0.5 Watt CW	

Mechanical Specifications & Ordering Part Number

Ordering Part Number	1001312
Size (mm)	2.00 x 1.20 x 0.55
Mounting	SMT
Weight (grams)	0.003
Packaging	Tape & Reel, 1001312 – 1,000 pieces per reel
Demo Board	1001312-01 (2.400 - 2.485 GHz) 1001312-04 (UWB 6.000 - 8.500 GHz)



2.4GHz Ethertronics' Embedded Antenna Specifications
Ethertronics produces a wide variety of standard and custom antennas to meet user needs.

Antenna Dimensions

Typical antenna dimensions (mm)

Part Number	A (mm)	B (mm)	C (mm)
1001312	2.0 ± 0.3	1.2 ± 0.3	0.55 ± 0.2

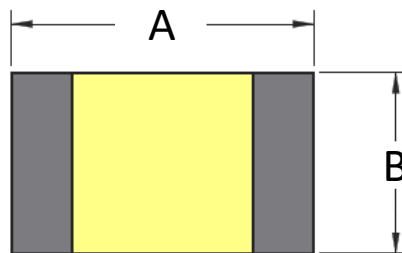
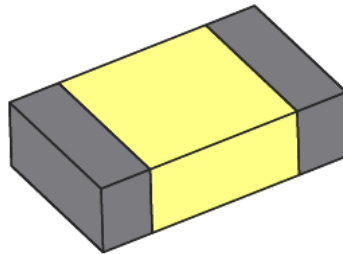

Top View

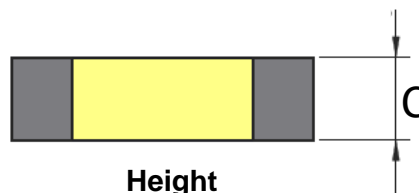

Height

Pin	Description
1	Feed
2	Ground

*Pin #1 and Pin #2 are interchangeable.

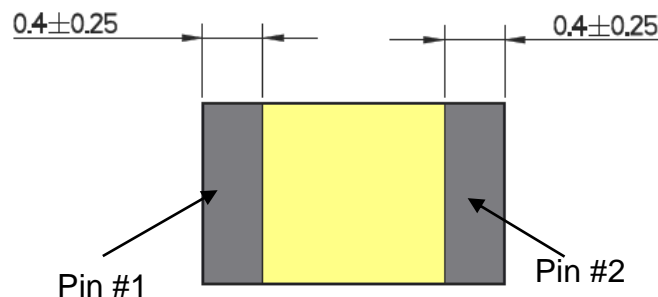

Bottom View



2.4GHz Ethertronics' Embedded Antenna Specifications
Ethertronics produces a wide variety of standard and custom antennas to meet user needs.

VSWR, Efficiency Plots

Typical performance on 55 x 25 mm PCB

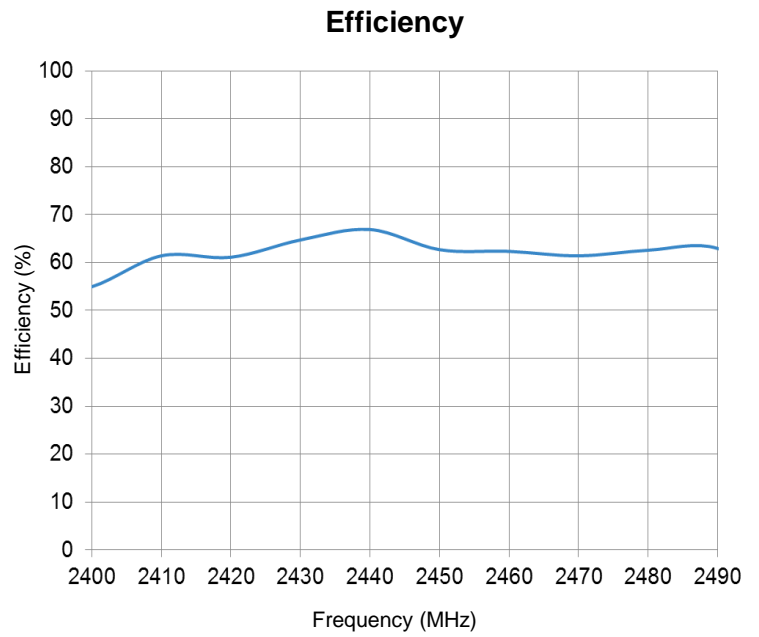
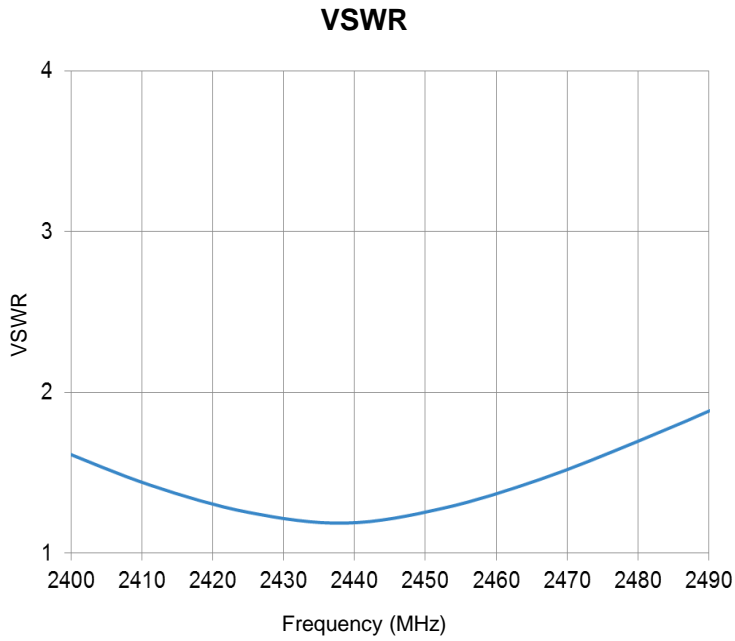

Antenna Radiation Patterns

Typical performance on 55 x 25 mm PCB
Measured @ 2440 MHz

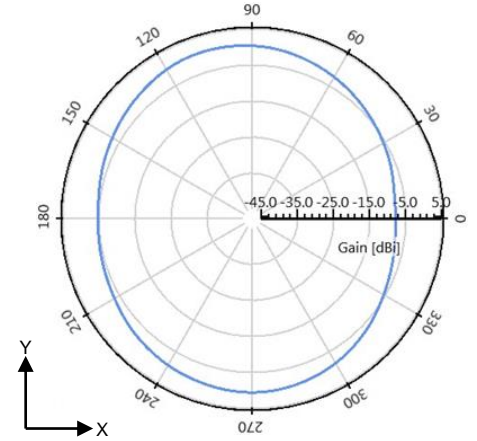
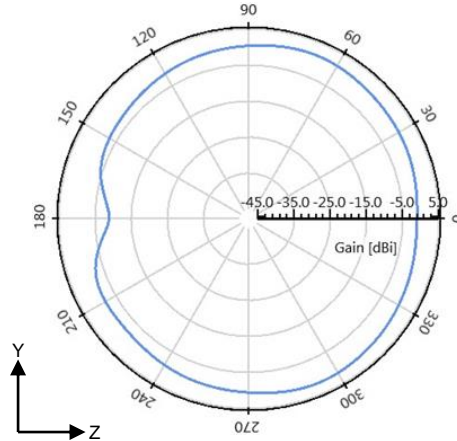
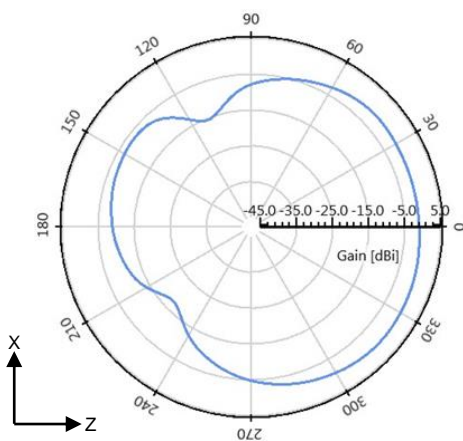



2.4GHz Ethertronics' Embedded Antenna Specifications

Ethertronics produces a wide variety of standard and custom antennas to meet user needs.

Antenna Layout (1001312-01)

Typical layout dimensions (mm)

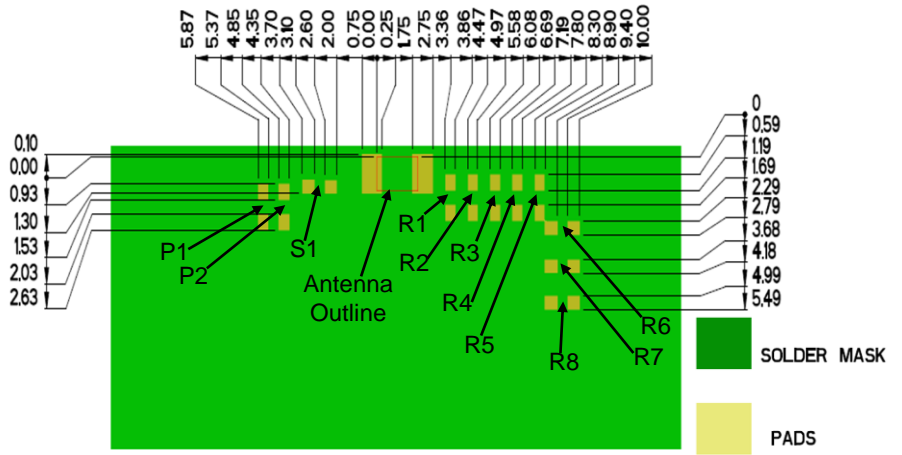
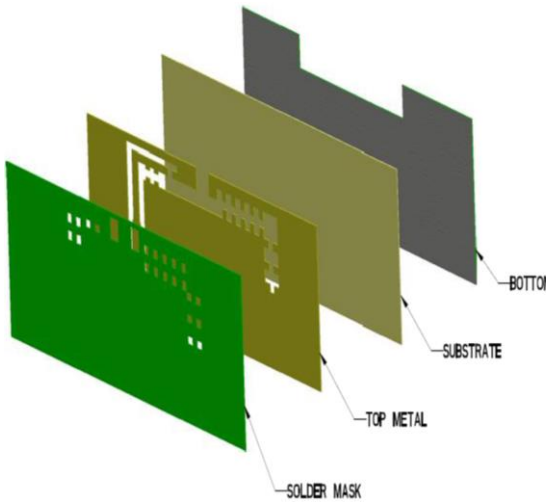

- Additional VIAS : Diam. 0.2mm to be placed around antenna, (no vias on transmission lines).
- Via holes must be covered by solder mask

Pin Descriptions

Pin#	Description
1	Feed
2	Ground

Matching Pi Network (Demo Board)

Component	Value	Tolerance
P1	4.7nH	±0.1nH
P2	DNI	N/A
S1	0Ω	N/A
R1	0Ω	N/A
R2 – R8	DNI	N/A

*Actual matching values depend on customer design

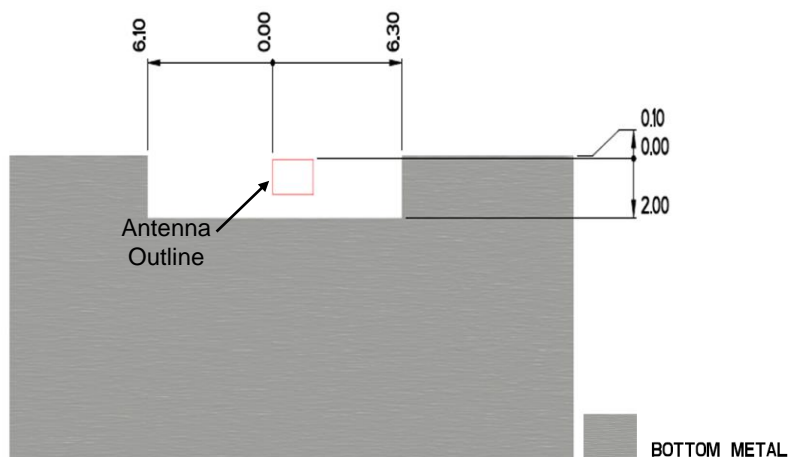
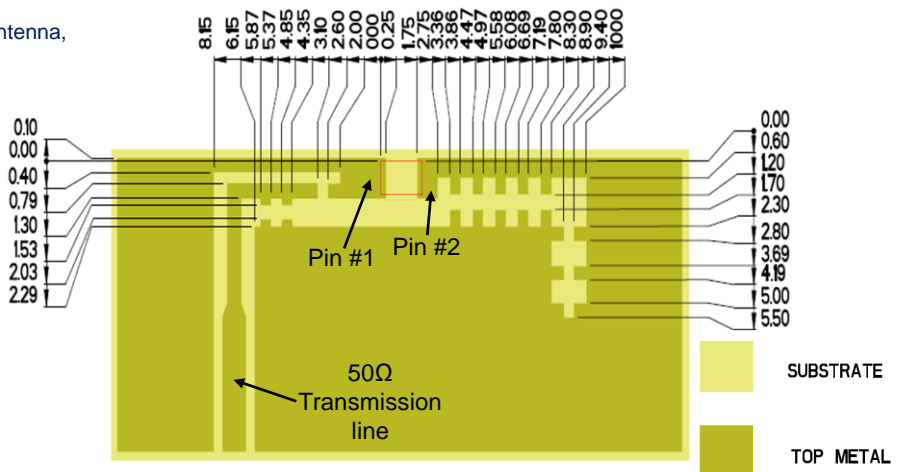
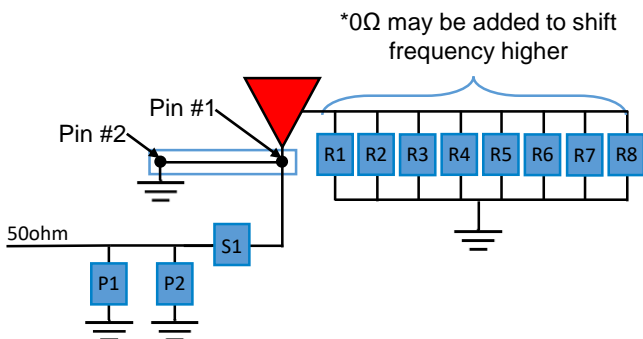



2.4GHz Ethertronics' Embedded Antenna Specifications

Ethertronics produces a wide variety of standard and custom antennas to meet user needs.

Antenna Layout Tips (General reference)

Important layout guidelines for correct operation of Ethertronics Ceramic Antennas. Please read guidelines below before laying out the antenna in a device. Figure 1 shows the typical antenna layout. Figure 2 shows Ethertronics' antenna layout.

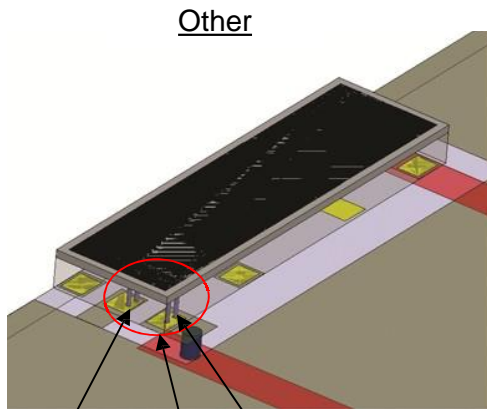

Shorting pin Feed pin
Antenna tuning loop:
Figure 1
Typical antenna layout

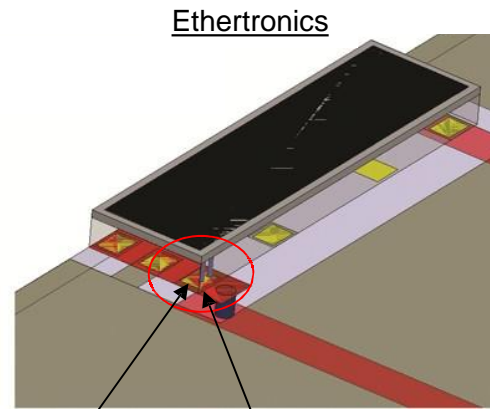

Shorting pin and feed pin are shared in
Ethertronics ceramic antennas

Figure 2
Ethertronics antenna layout
(required)

- The antenna tuning loop is formed by the PCB layout.
- The feed pin and shorting pin are combined because it requires very close proximity to achieve more band- width.



2.4GHz Ethertronics' Embedded Antenna Specifications

Ethertronics produces a wide variety of standard and custom antennas to meet user needs.

Antenna Demo Board

Typical layout dimensions (mm)

Part Number	A (mm)	B (mm)	C (mm)
1001312-01	55.0	25.0	26.0

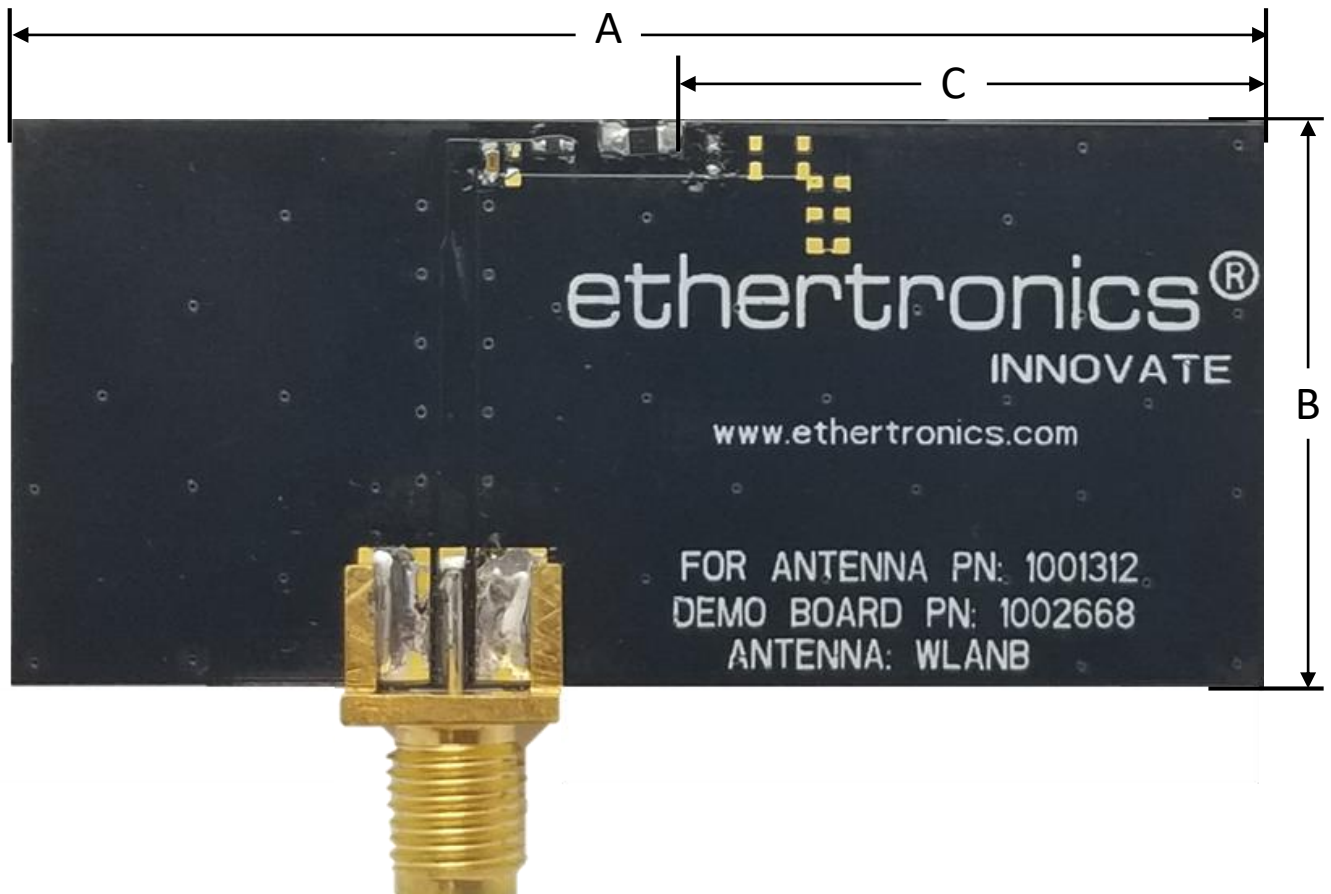



Appendix 1 UWB Ceramic Ethertronics' Embedded Antenna Specifications
Ethertronics produces a wide variety of standard and custom antennas to meet user needs.

Appendix 1

Appendix 1 gives instructions on how to achieve UWB performances through layout and impedance matching network.
(6.0 – 8.5 GHz)

Frequency (GHz)	6.0 – 8.5
Peak Gain	4.8 dBi
Average Efficiency	84%
VSWR Match	2.0:1 max
Feed Point Impedance	50 ohms unbalanced
Polarization	Linear
Power Handling	2 Watt CW

*Data shown above has Appendix 1 matching applied on 26.0 x 25.0 mm PCB,
Using UWB 1001312-04 layout





Appendix 1 UWB Ceramic Ethertronics' Embedded Antenna Specifications
Ethertronics produces a wide variety of standard and custom antennas to meet user needs.

VSWR, Efficiency Plots

Typical performance on 26.0 x 25.0 mm PCB

VSWR

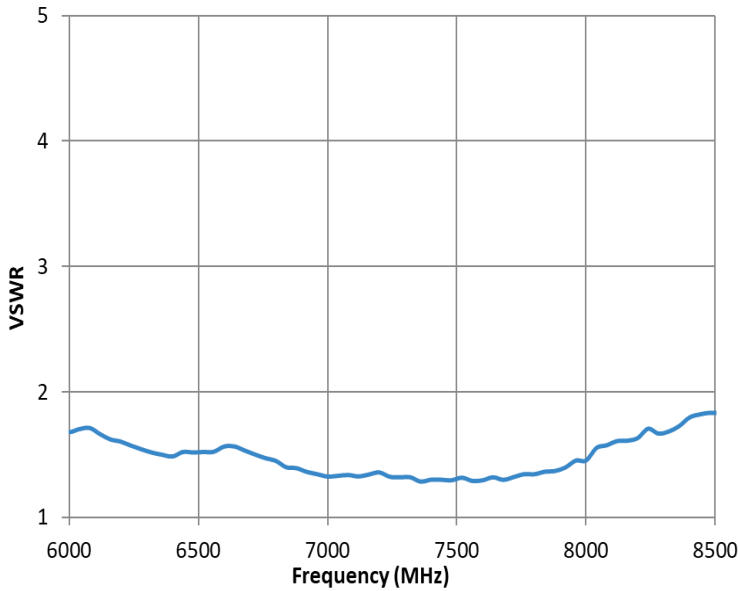

Efficiency

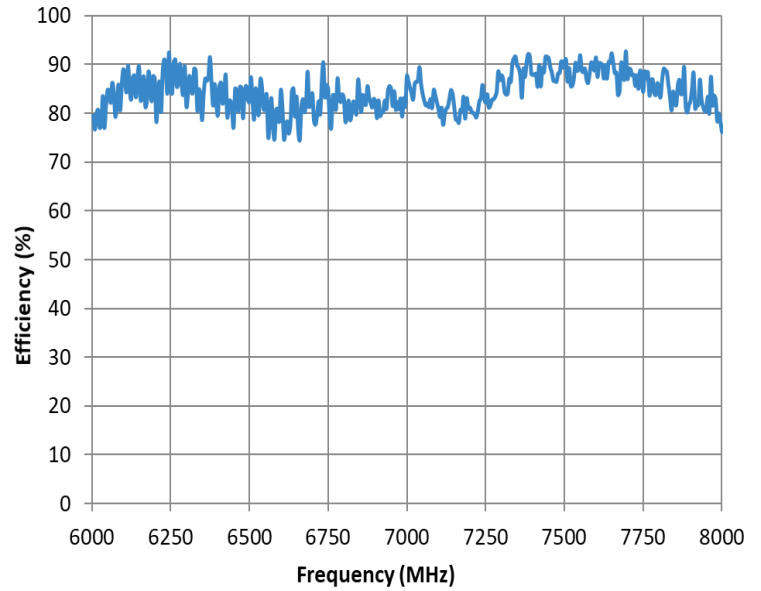

Antenna Radiation Patterns

Typical performance on 26.0 x 25.0 mm PCB
Measured @ 6500, 7000, 8000 MHz

- 6500 MHz
- 7000 MHz
- 8000 MHz

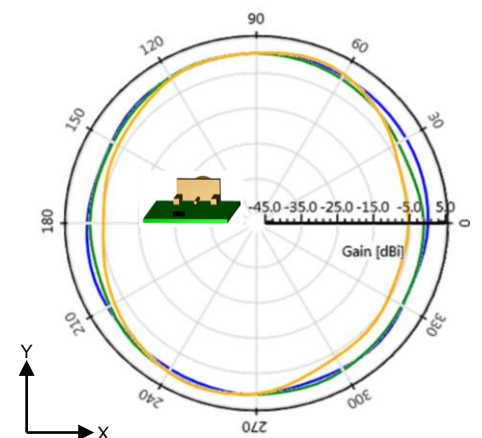
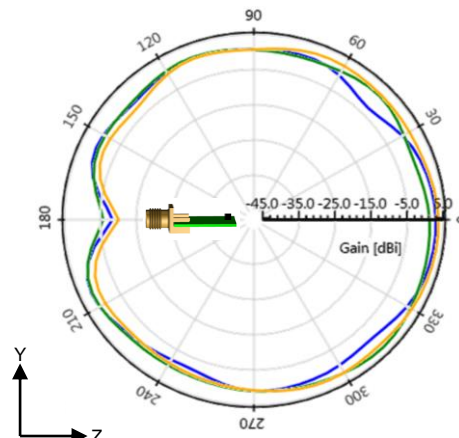
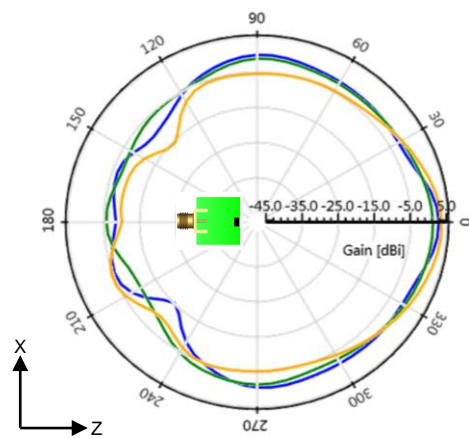
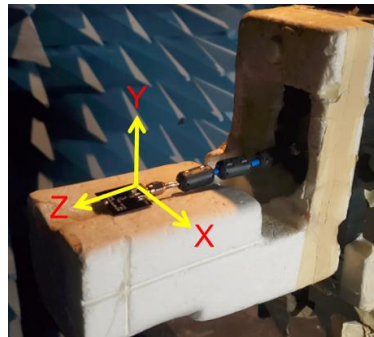



Appendix 1 UWB Ceramic Ethertronics' Embedded Antenna Specifications
Ethertronics produces a wide variety of standard and custom antennas to meet user needs.

Antenna Layout (1001312-04)

Typical layout dimensions (mm)

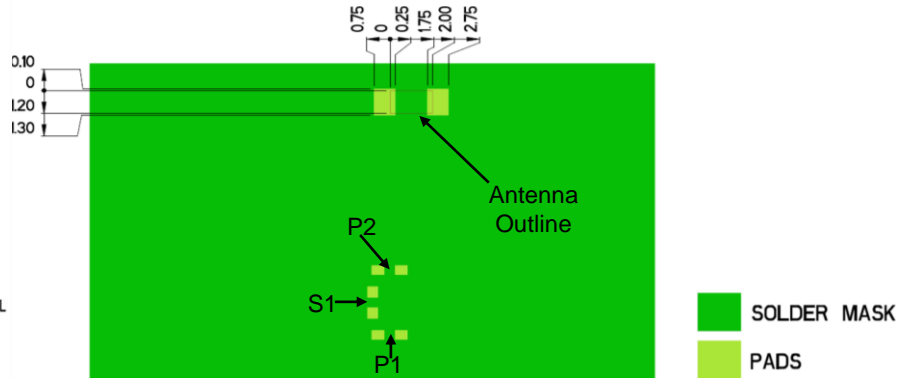
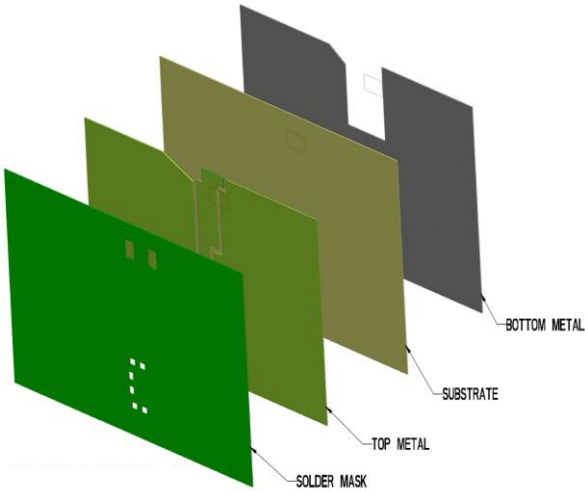

- Additional VIAS : Diam. 0.2mm to be placed around antenna, (no vias on transmission lines).
- Via holes must be covered by solder mask

Pin Descriptions

Pin#	Description
1	Feed
2	Ground

Matching Pi Network (Demo Board)

Component	Value	Tolerance
P1	DNI	N/A
S1	0Ω	N/A
P2	DNI	N/A

*Actual matching values depend on customer design

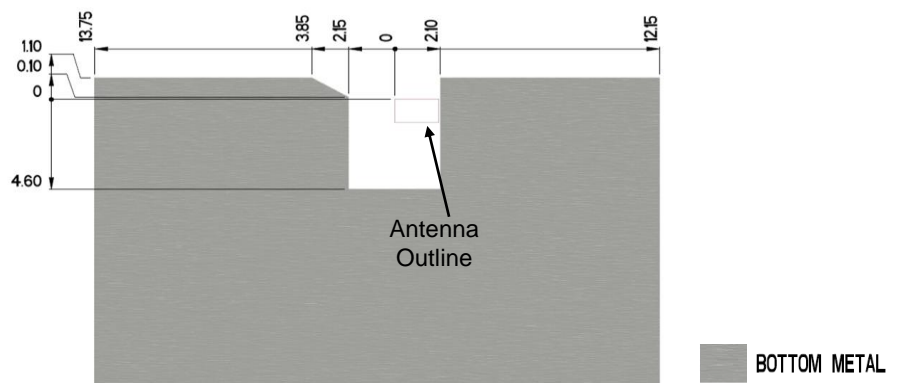
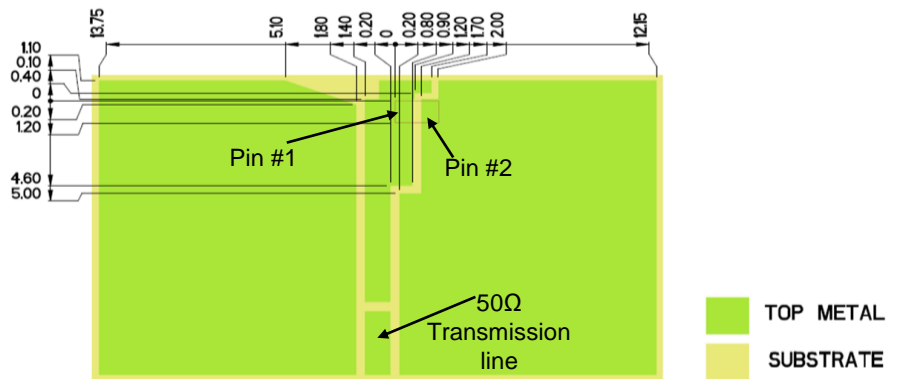
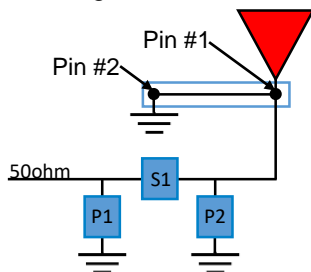



Appendix 1 UWB Ceramic Ethertronics' Embedded Antenna Specifications
Ethertronics produces a wide variety of standard and custom antennas to meet user needs.

Antenna Demo Board

Typical layout dimensions (mm)

Part Number	A (mm)	B (mm)	C (mm)
1001312-04	26.0 ± 0.25	25.0 ± 0.25	10.15

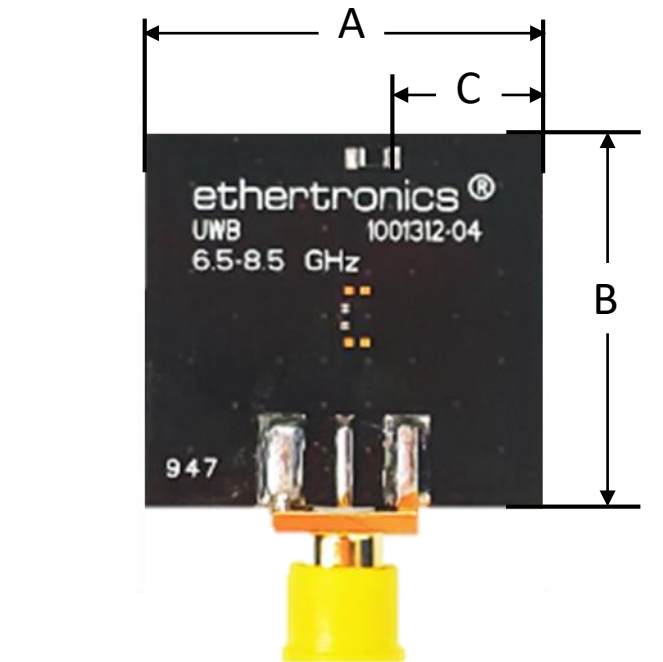

X-ON Electronics

Largest Supplier of Electrical and Electronic Components

Click to view similar products for [Antenna Development Tools](#) category:

Click to view products by [Kyocera AVX](#) manufacturer:

Other Similar products are found below :

[0868AT43A0020-EB1SMA](#) [EVALBGSA141MN10TOBO1](#) [A10393-U1](#) [PCSD.06.A](#) [B5771-U1](#) [KIT-LTE-GNSS-01](#) [KIT-WIFI-ISM-01](#)
[A10472-U1](#) [REFLECTOR-EVB-1](#) [A10340-U1](#) [ACAG0201-2450-EVB](#) [ACAG0301-15752450-EVB](#) [ACAG0301-1575-EVB](#) [ACAG0301-24505500-EVB](#) [ACAG0301-5500-EVB](#) [ACAG0801-2450-EVB](#) [ACAG1204-433-EVB](#) [ACAG1204-868-EVB](#) [ACAG1204-915-EVB](#)
[ACAR0301-SW2-EVB](#) [ACAR3005-C2WB-EVB](#) [ACAR3005-S824-EVB](#) [ACAR3705-S698-EVB](#) [ACAR4008-S698-EVB](#) [A10137-D](#)
[A10194-U1](#) [A10204-U1](#) [A5645H-EVB-1](#) [A5645-U1](#) [A5887H-EVB-1](#) [A6111-U1](#) [M20057-EVB-1](#) [SR42W001-U1](#) [SR42W009-U1](#)
[SR4G008-U1](#) [SR4G013-U1](#) [SR4G053-EVB-1](#) [SR4L049-EVB-1](#) [SRC5G027-U1](#) [SRCW004-U1](#) [1001312-01](#) [M310220-01](#) [M620720-01](#)
[M830120-01](#) [M830520-01](#) [EB_NN01-105A](#) [EB_NN02-201-5G](#) [CCKLTE450-NA](#) [AEK-GNCP-TH258L15](#) [MPA-104- KIT](#)