



Part No. 1001388 / 1001430

5 GHz Single Band Stamped Metal Embedded Antenna

5 GHz

Supports: Wi-Fi applications, Agriculture, Automotive, WLAN, Smart Home, Healthcare, Digital Signage, MIMO Applications



Ethertronics' 1001388 & 1001430 are the World's SMALLEST 5 GHz High Performance Stamped Metal antennas. These antennas are designed for WLAN MIMO enabled devices including routers, media players, and other mobile communications devices.

Real-World Performance and Implementation

Ethertronics Stamped metal antennas are designed to produce optimal performance and 3D radiation patterns, offering increased coverage range without compromising on footprint dimensions.

Greater Flexibility

Ethertronics' first-in-class technology enables the advance concept designs that deliver superior performance in reception critical applications.

5 GHz Single Band Stamped Metal Embedded Antenna

4900– 5900 MHz

KEY BENEFITS

Stay-in-Tune

Ethertronics antenna technology provides superior RF field containment, resulting in less interaction with surrounding components.

Quicker Time-to-Market

By optimizing antenna size, performance and emissions, customer and regulatory specifications are more easily met.

Reliability

Products are the latest RoHS version compliant

APPLICATIONS

- Embedded design
- Cellular, Headsets, Tablets
- Gateway, Access Point
- Handheld
- Telematics
- Tracking
- Healthcare
- M2M, Industrial devices
- Smart Grid
- OBD-II

Electrical Specifications

Typical performance on 75 x 75 mm PCB

Frequency (MHz)	5150 - 5825	5150 - 5825
Part Number #	1001388	1001430
Peak Gain	3.5 dBi	4.5 dBi
Average Efficiency	73%	72%
Return Loss in dB	< -10 dB	
Feed Point Impedance	50 ohms unbalanced	
Polarization	Linear	
Power Handling	2.0 Watt CW	

Mechanical Specifications & Ordering Part Number

Ordering Part #	1001388	1001430
Dimensions (mm)	8.75 x 4.05 x 2.01	8.75 x 4.05 x 2.01
Mounting Type	SMT	
Weight (grams)	0.025	
Packaging	Tape & Reel, 2K pcs/Reel	
Demo Board	1003666-01	



5 GHz Stamped Metal Ethertronics' Embedded Antenna Specifications
Ethertronics produces a wide variety of standard and custom antennas to meet user needs.

Antenna Dimensions (1001388)

Typical antenna dimensions (mm)

Part Number	A (mm)	B (mm)	C (mm)
1001388	8.75 ± 0.3	4.05 ± 0.3	2.01 ± 0.3

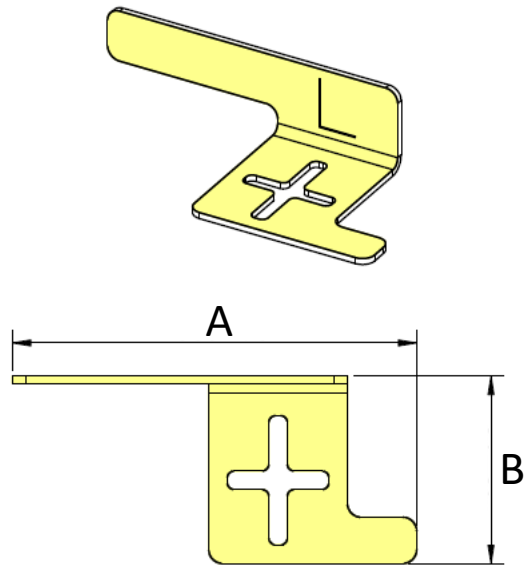

Top View

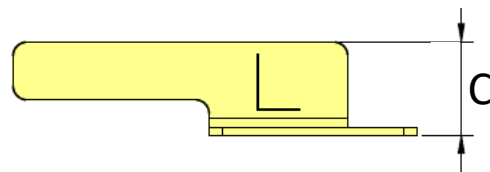

Height

Pin#	Description
1	Feed
2	Ground

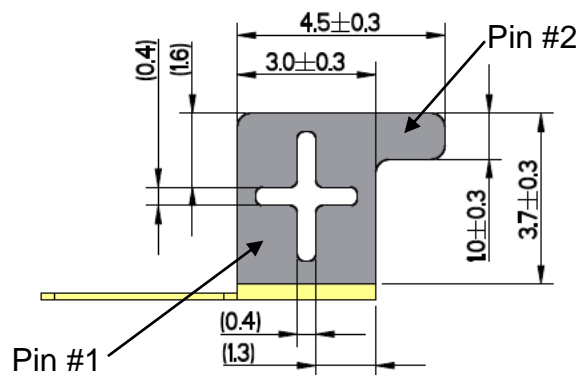

Bottom View



5 GHz Stamped Metal Ethertronics' Embedded Antenna Specifications
Ethertronics produces a wide variety of standard and custom antennas to meet user needs.

Antenna Dimensions (1001430)

Typical antenna dimensions (mm)

Part Number	A (mm)	B (mm)	C (mm)
1001430	8.75 ± 0.3	4.05 ± 0.3	2.01 ± 0.3

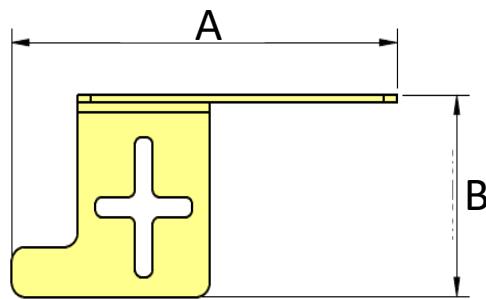
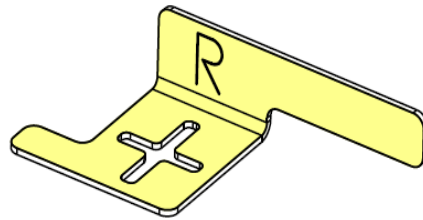

Top View

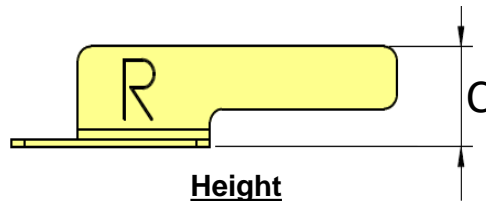

Height

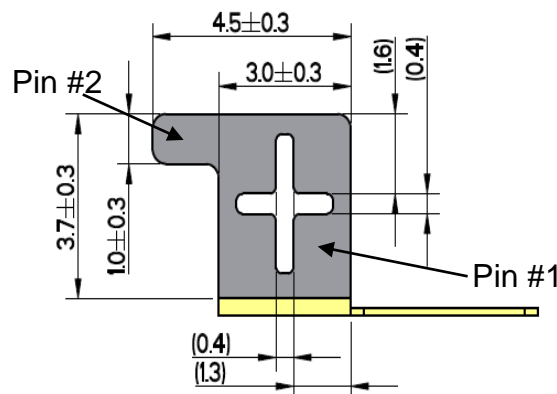

Bottom View

Pin#	Description
1	Feed
2	Ground



5 GHz Stamped Metal Ethertronics' Embedded Antenna Specifications
Ethertronics produces a wide variety of standard and custom antennas to meet user needs.

Return Loss and Efficiency Plots (1001388)

Typical performance on 75 x 75 mm PCB

VSWR

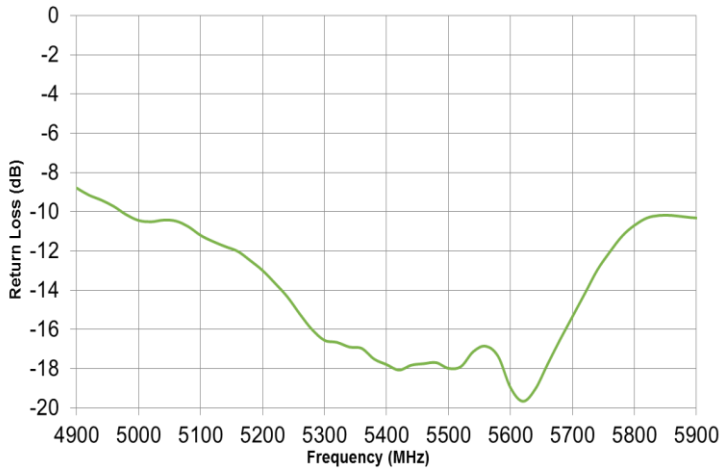

Efficiency

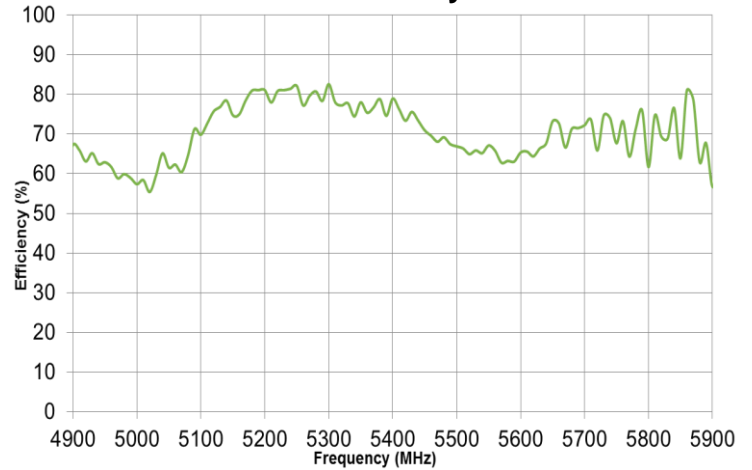

Antenna Radiation Patterns (1001388)

Typical performance on 75 x 75 mm PCB
Measured @ 5220, 5780 MHz

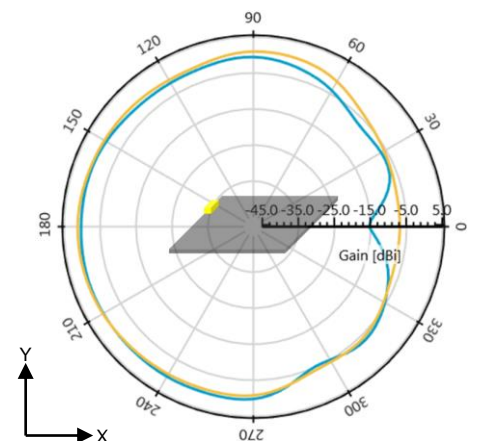
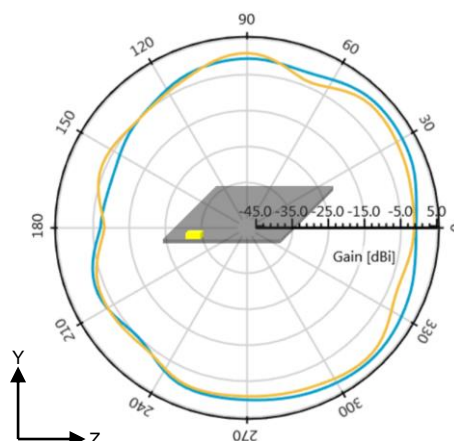
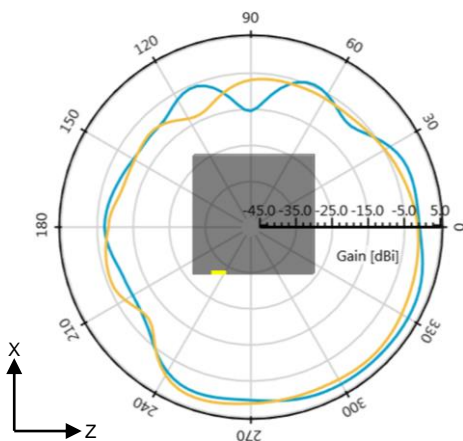
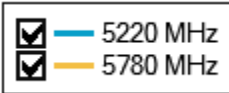



5 GHz Stamped Metal Ethertronics' Embedded Antenna Specifications
Ethertronics produces a wide variety of standard and custom antennas to meet user needs.

Return Loss and Efficiency Plots (1001430)

Typical performance on 75 x 75 mm PCB

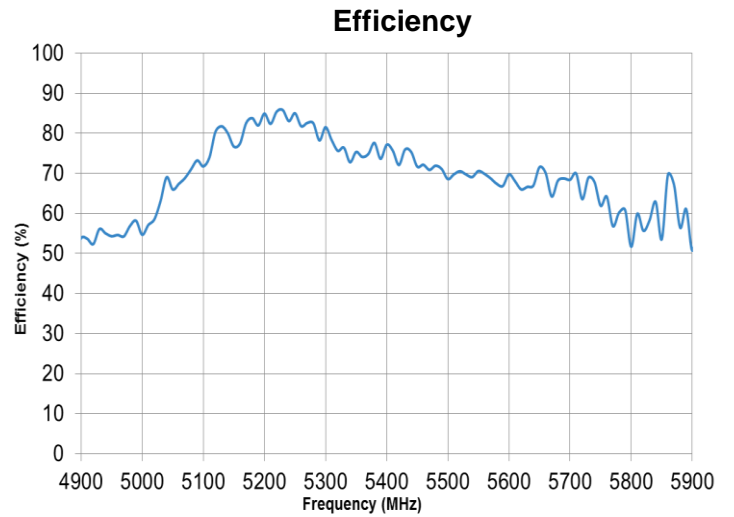
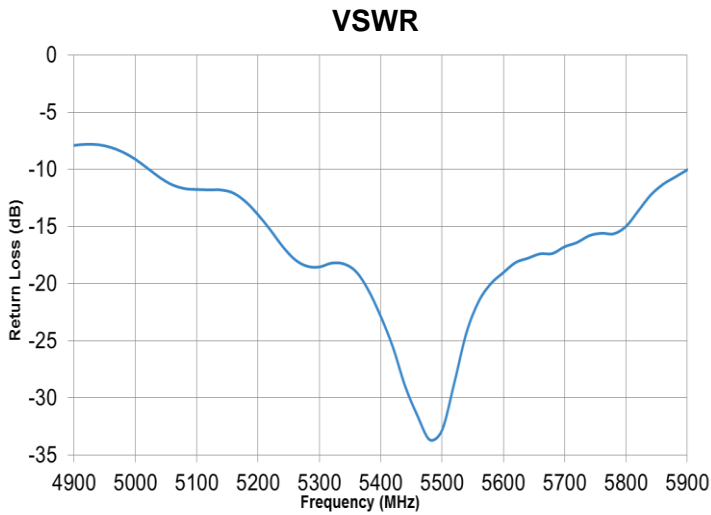

Antenna Radiation Patterns (1001430)

Typical performance on 75 x 75 mm PCB
Measured @ 5220, 5780 MHz

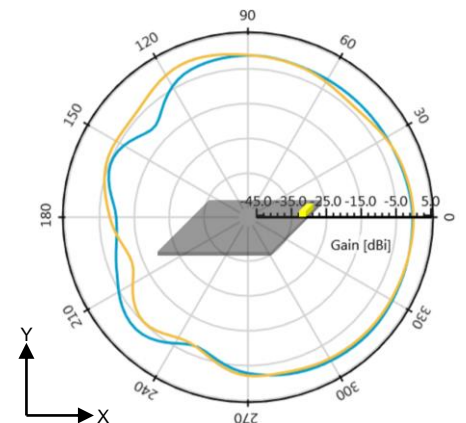
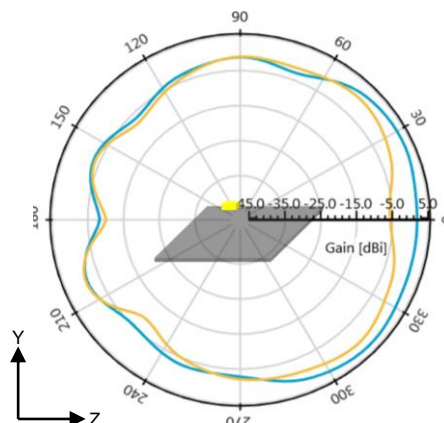
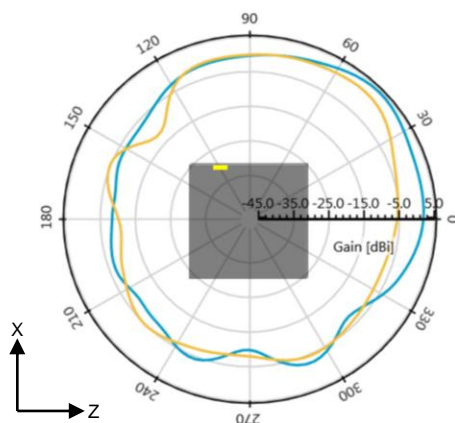
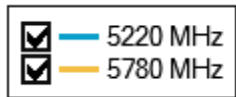



5 GHz Stamped Metal Ethertronics' Embedded Antenna Specifications
Ethertronics produces a wide variety of standard and custom antennas to meet user needs.

Antenna Layout (1001388)

Typical layout dimensions (mm)

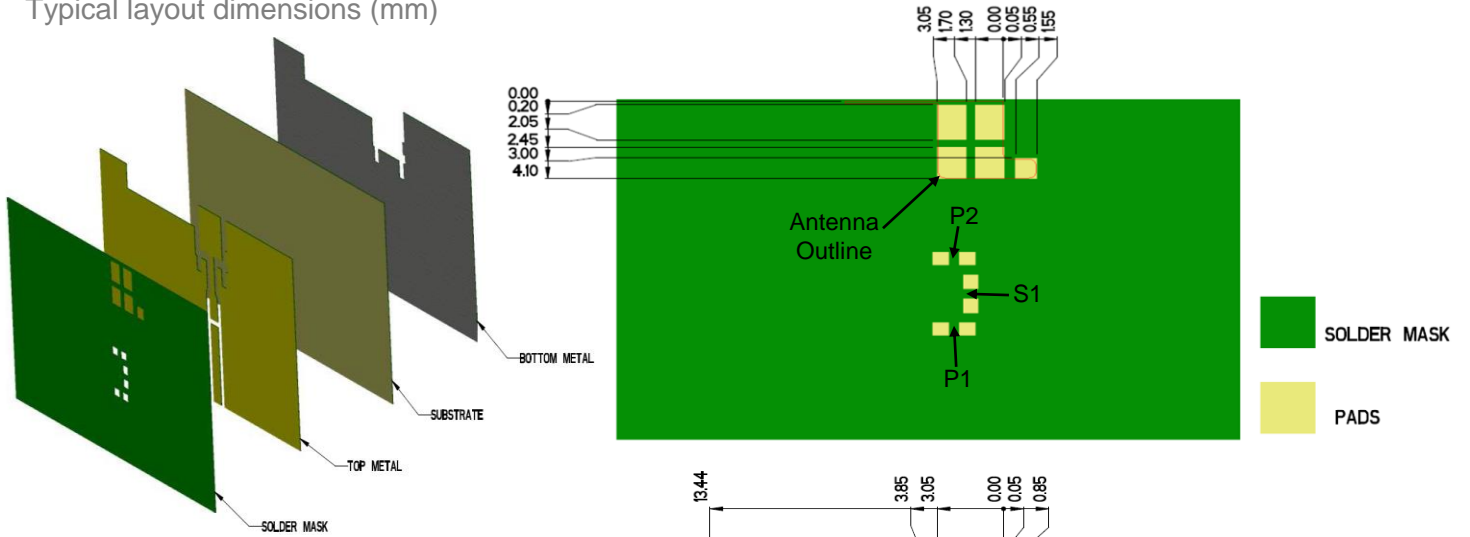

Pin Descriptions

Pin#	Description
1	Feed
2	Ground

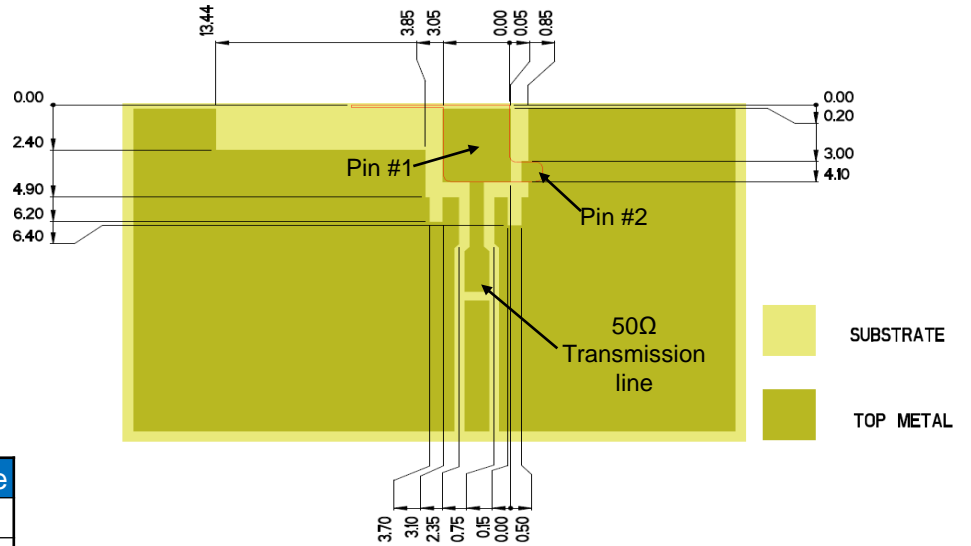

Matching Pi Network (Demo Board)

Component	Value	Tolerance
P1	DNI	DNI
S1	0Ω	N/A
P2	DNI	DNI

*Actual matching values depend on customer design

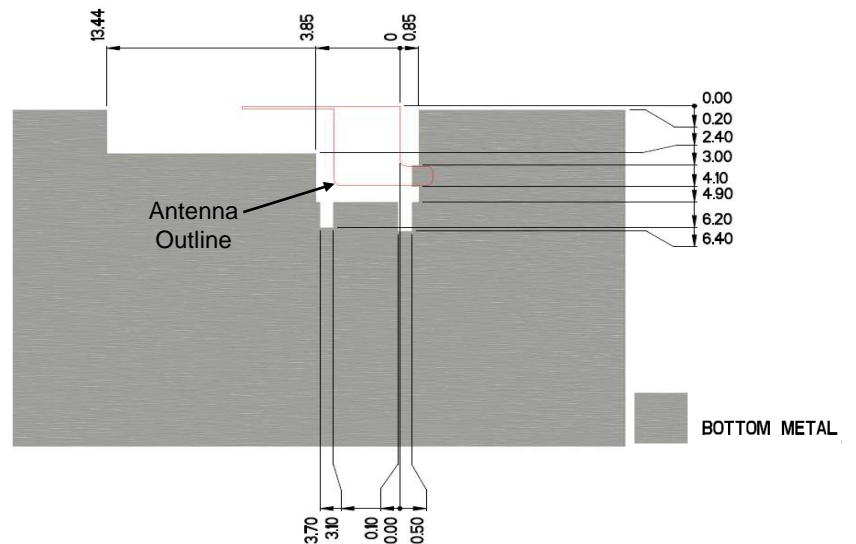
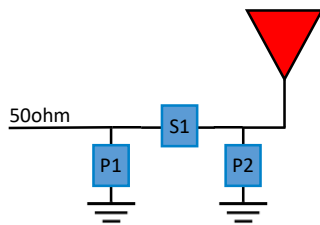



5 GHz Stamped Metal Ethertronics' Embedded Antenna Specifications
Ethertronics produces a wide variety of standard and custom antennas to meet user needs.

Antenna Layout (1001430)

Typical layout dimensions (mm)

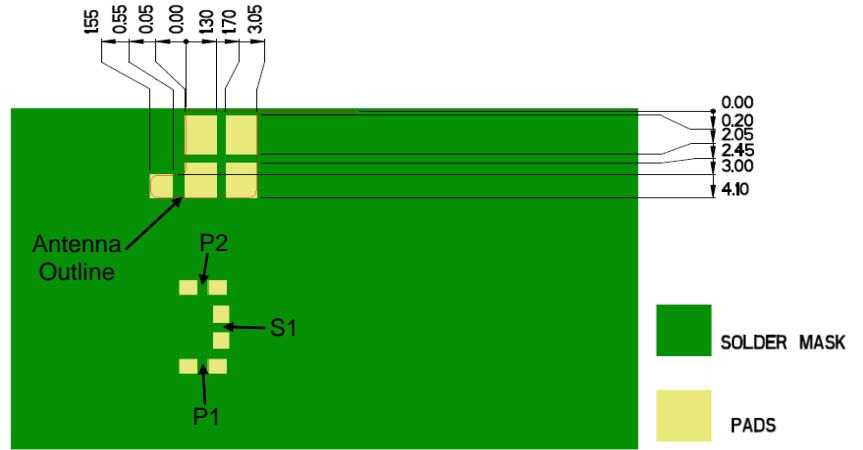
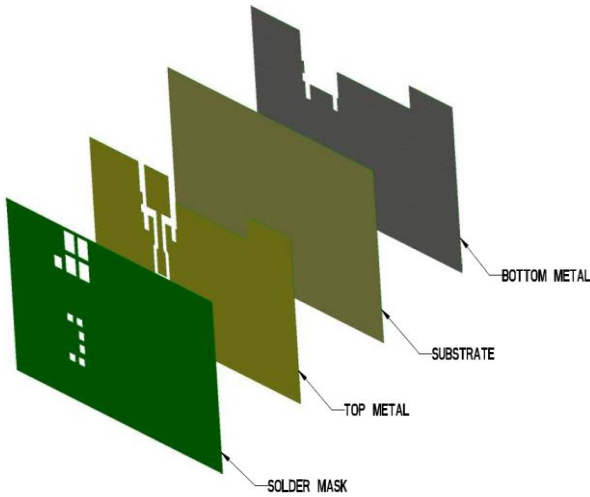

Pin Descriptions

Pin#	Description
1	Feed
2	Ground

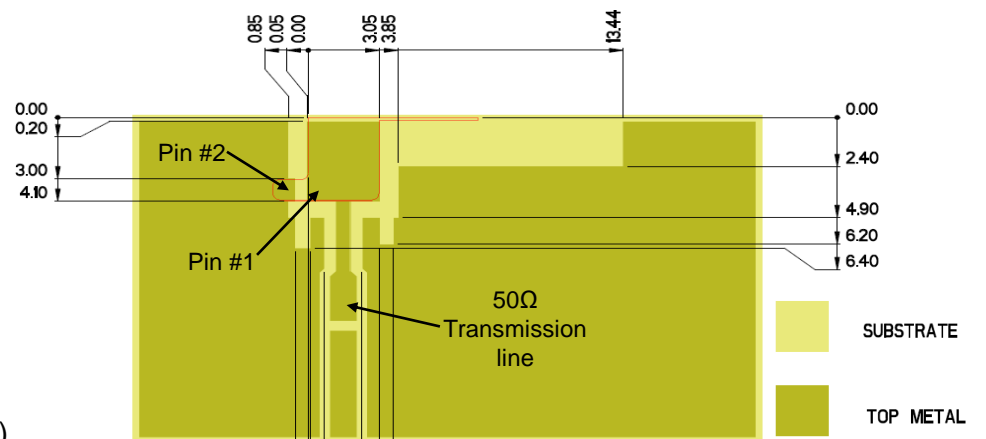

Matching Pi Network (Demo Board)

Component	Value	Tolerance
P1	DNI	DNI
S1	0Ω	N/A
P2	DNI	DNI

*Actual matching values depend on customer design

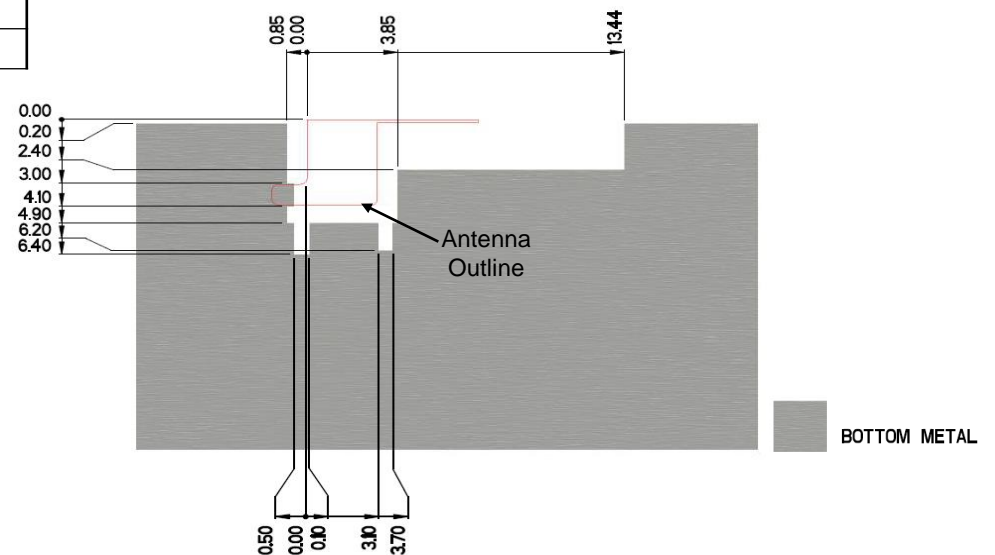
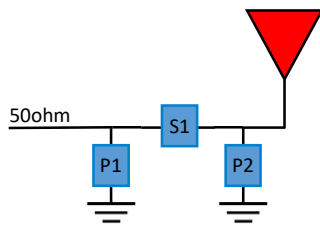



5 GHz Stamped Metal Ethertronics' Embedded Antenna Specifications
Ethertronics produces a wide variety of standard and custom antennas to meet user needs.

Antenna Demo Board

Typical layout dimensions (mm)

Part Number	A (mm)	B (mm)	C1 (mm)	C2 (mm)
1003666-01	75.0	75.0	10.5	10.5

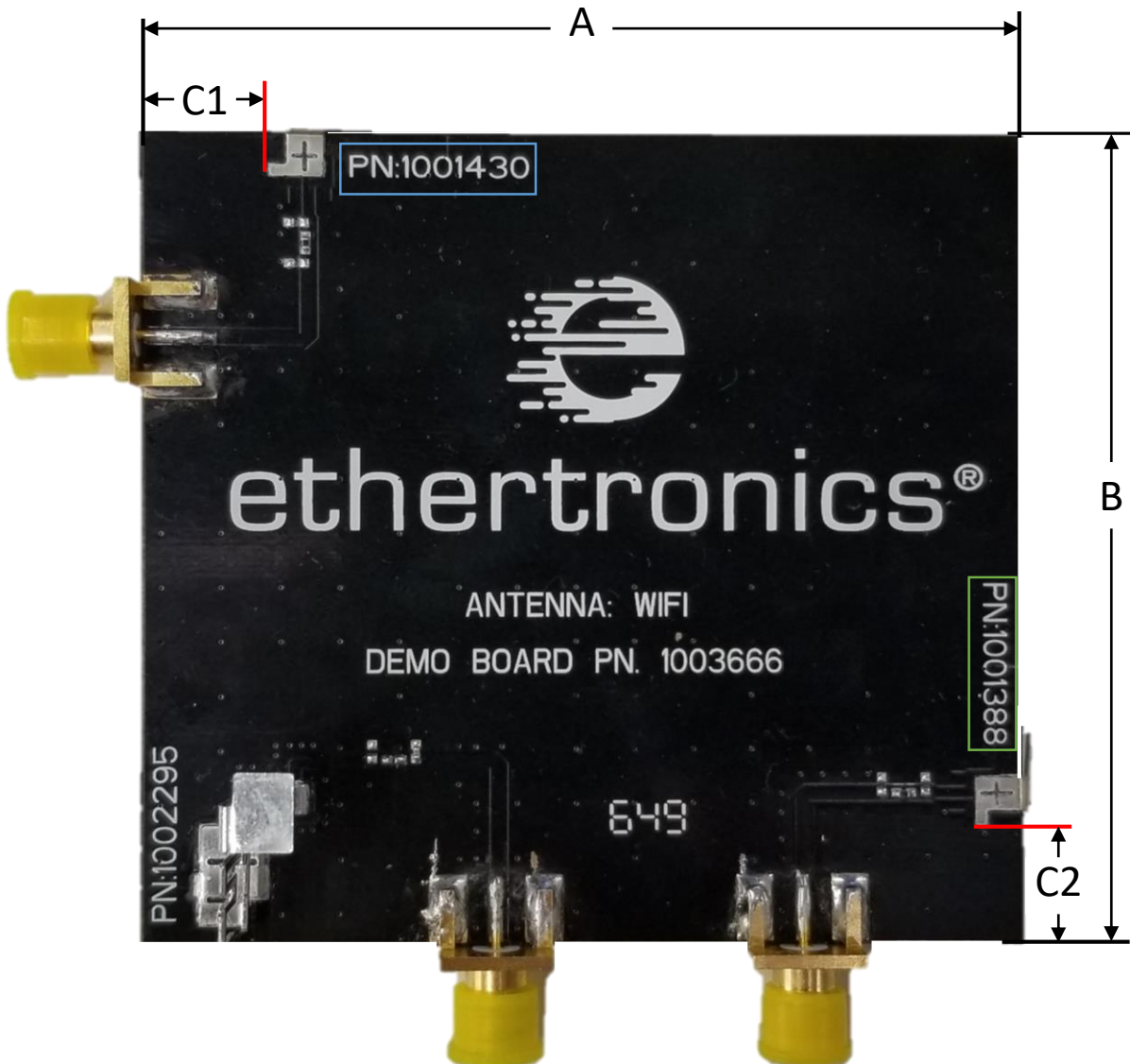

X-ON Electronics

Largest Supplier of Electrical and Electronic Components

Click to view similar products for [Antennas](#) category:

Click to view products by [Kyocera AVX](#) manufacturer:

Other Similar products are found below :

[GAN30084EU](#) [930-033-R](#) [GW17.07.0250E](#) [1513563-1](#) [EXE902SM](#) [APAMPG-117](#) [MAF94383](#) [W3908B0100](#) [W6102B0100](#) [YE572113-30RSMM](#) [108-00014-50](#) [66089-2406](#) [SPDA17RP918](#) [A09-F8NF-M](#) [A09-F5NF-M](#) [RGFRA1903041A1T](#) [W3593B0100](#) [W3921B0100](#) [SIMNA-868](#) [SIMNA-915](#) [SIMNA-433](#) [W1044](#) [W1049B090](#) [A75-001](#) [WTL2449CQ1-FRSMM](#) [CPL9C](#) [EXB148BN](#) [0600-00060](#) [TRA9020S3PBN-001](#) [Y4503](#) [GD5W-28P-NF](#) [MA9-7N](#) [GD53-25](#) [GD5W-21P-NF](#) [C37](#) [MAF94051](#) [MA9-5N](#) [EXD420PL](#) [B1322NR](#) [QWFTB120](#) [MAF94271](#) [MAF94300](#) [GPSMB301](#) [FG4403](#) [AO-AGSM-OM54](#) [5200232](#) [MIKROE-2349](#) [WCM.01.0111](#) [MIKROE-2393](#) [MIKROE-2352](#)