



Part No. 1002232

ISM & WLAN FR4 Embedded Antenna

868 MHz, 915 MHz, 2.4 GHz

Supports: WLAN applications, Agriculture, Automotive, Bluetooth, Tracking, Smart Home, Healthcare, Digital Signage, LoRa, Sigfox



ISM & WLAN FR4 Embedded Antenna

863-928 MHz, 2.400 - 2500 GHz

KEY BENEFITS

Versatile Antenna

1002232 can be used to support ISM and WLAN combined, allowing reduced BOM complexity while maintaining great performances.

Quicker Time-to-Market

By optimizing antenna size, performance and emissions, customer and regulatory specifications are more easily met.

Reliability

Products are the latest RoHS version compliant.

APPLICATIONS

- Embedded design
- Cellular, Headsets, Tablets
- Gateway, Access Point
- SRD868
- Telematics
- Tracking
- Healthcare
- M2M, Industrial devices
- Smart Grid
- OBD-II

KYOCERA AVX 1002232 FR4 antenna delivers the device designers' key needs for higher functionality and performance in smaller/thinner designs. This innovative antenna provides compelling advantages for all ISM and WLAN enabled devices.

Unique Form Factors Support Advanced Industrial Designs

Smaller, more efficient on-board embedded antennas break through restrictive design rules and provide new freedom in component placement.

Electrical Specifications

Typical performance on 110 x 50 mm PCB in free space.

Frequency	ISM EU 863 - 870 MHz	ISM US 902 - 928 MHz	WLAN 2400 - 2500 MHz
Peak Gain	0.51 dBi	0.21 dBi	1.5 dBi
Average Efficiency	63%	60%	59%
VSWR Match	2.0:1 max		
Feed Point Impedance	50 ohms unbalanced		
Polarization	Linear		
Power Handling	2 Watt CW		

Mechanical Specifications & Ordering Part Number

Ordering Part Number	1002232
Size (mm)	35.0 x 9.0 x 3.2
Weight (grams)	2.0
Mounting	SMT (P&P)
Packaging	Tape & Reel, 5,600 pieces per box, 1,120 per reel
Demo Board	1002232-01

ISM / WLAN FR4 KYOCERA AVX Antenna Specifications
 KYOCERA AVX produces a wide variety of standard and custom antennas to meet user needs.

Antenna Dimensions (1002232)

Typical antenna dimensions (mm)

Part Number	A (mm)	B (mm)	C (mm)
1002232	35.0 ± 0.3	9.0 ± 0.2	3.2 ± 0.3

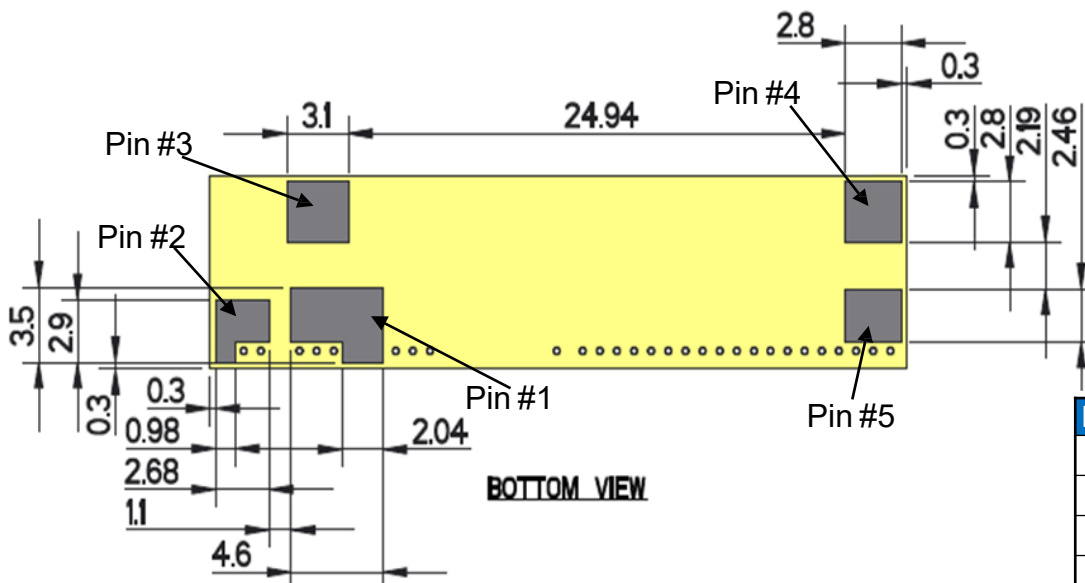
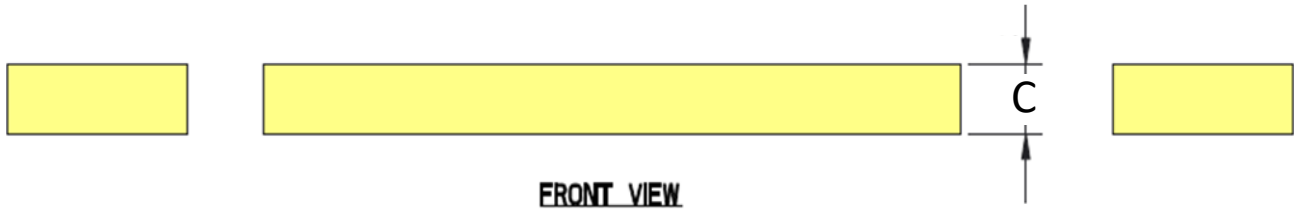
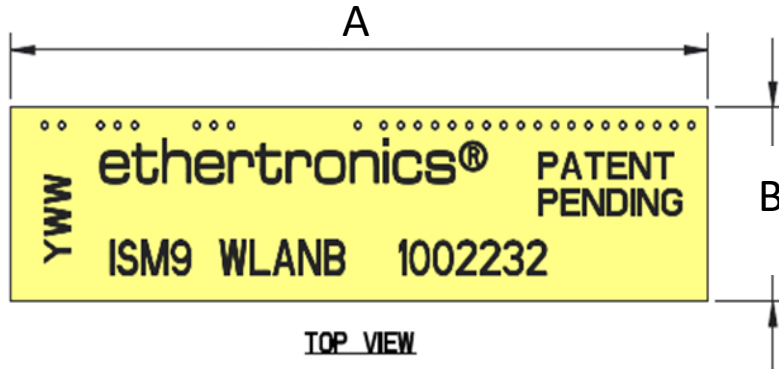

Pin#	Description
1	Feed
2	Ground
3	Dummy Pad
4	Dummy Pad
5	Dummy Pad

ISM / WLAN FR4 KYOCERA AVX Antenna Specifications
 KYOCERA AVX produces a wide variety of standard and custom antennas to meet user needs.

VSWR and Efficiency Plots

Typical performance on 110 x 50 mm PCB



ISM VSWR

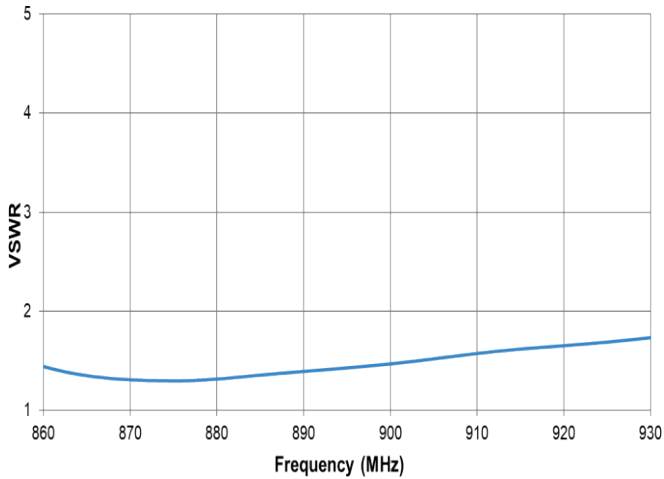

WLAN VSWR

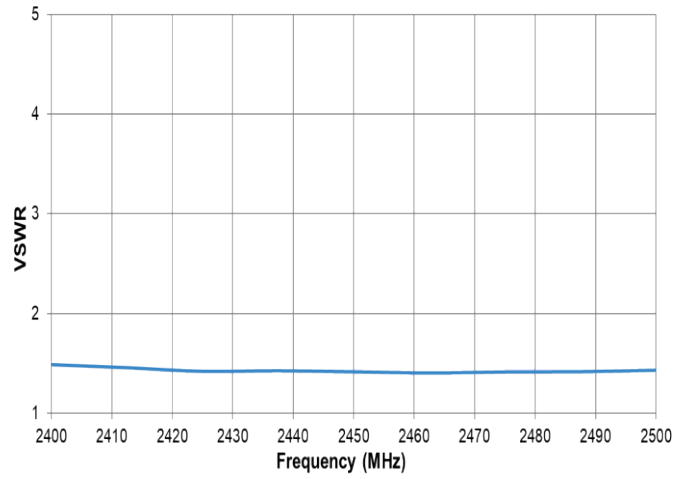

ISM Efficiency

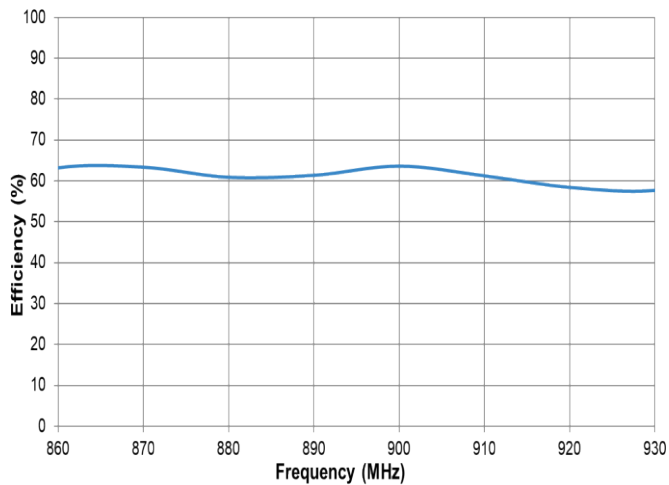

WLAN Efficiency

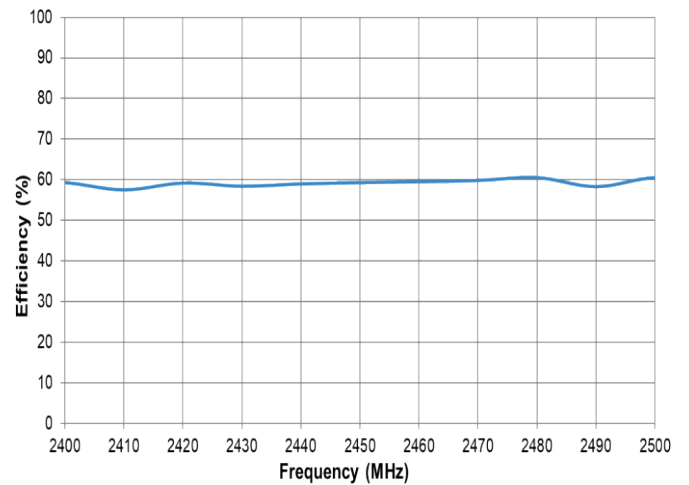

ISM / WLAN FR4 KYOCERA AVX Antenna Specifications
 KYOCERA AVX produces a wide variety of standard and custom antennas to meet user needs.

Antenna Radiation Patterns

Typical performance on 110 x 50 mm PCB
 Measured @ 868, 900, 2400 MHz

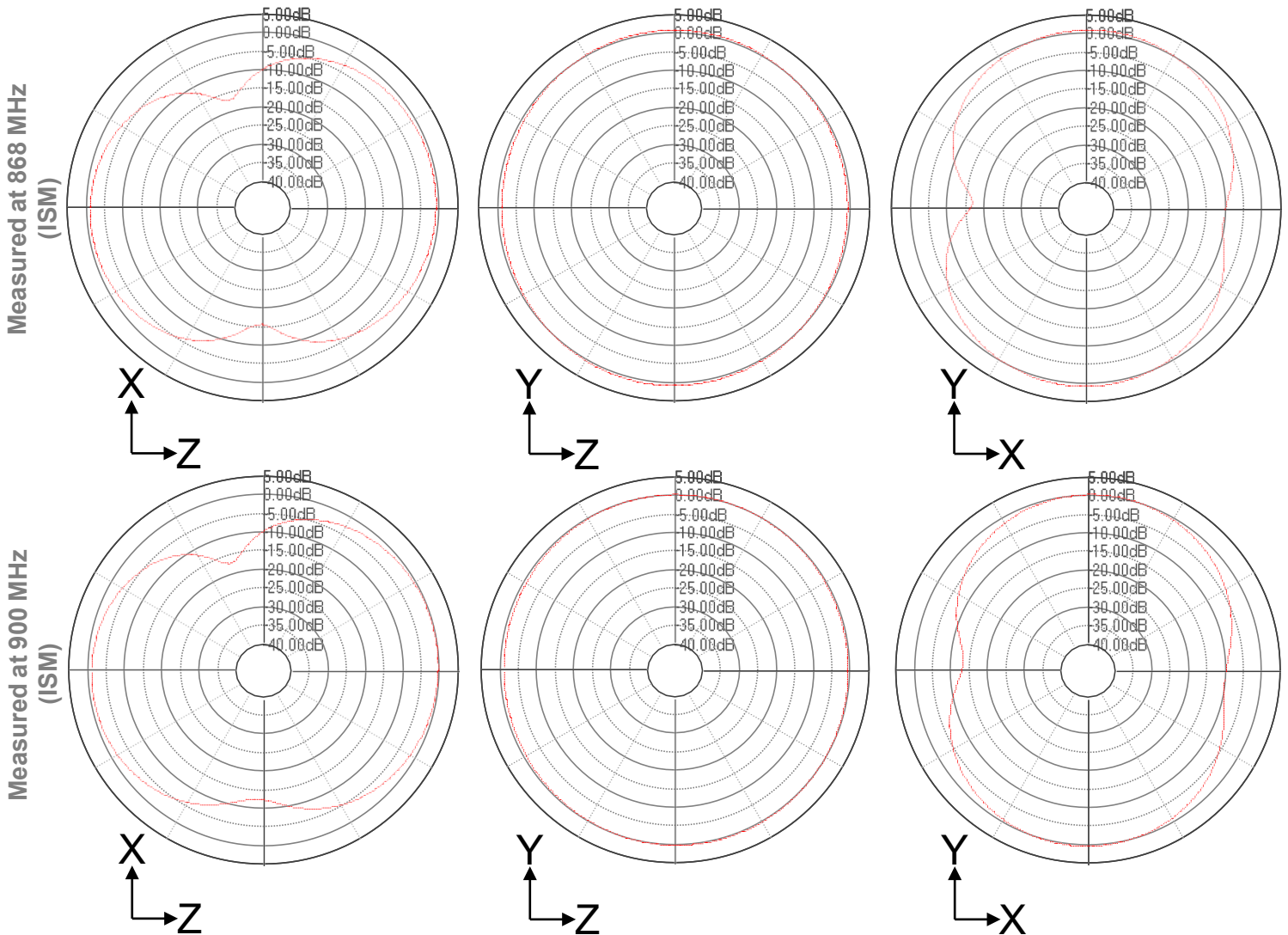
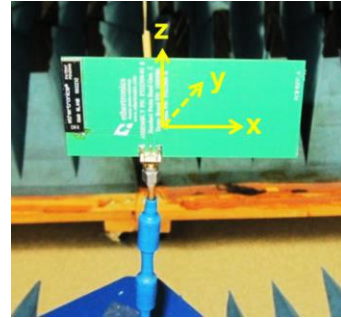
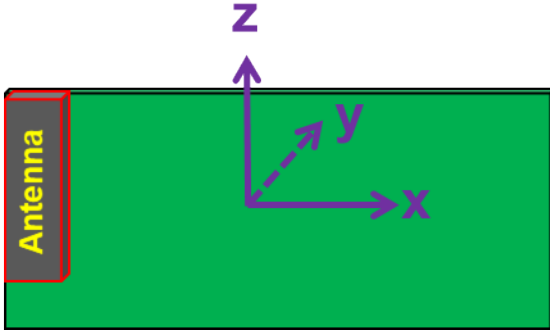

ISM / WLAN FR4 KYOCERA AVX Antenna Specifications
 KYOCERA AVX produces a wide variety of standard and custom antennas to meet user needs.

Antenna Radiation Patterns

Typical performance on 110 x 50 mm PCB
 Measured @ 868, 900, 2400 MHz

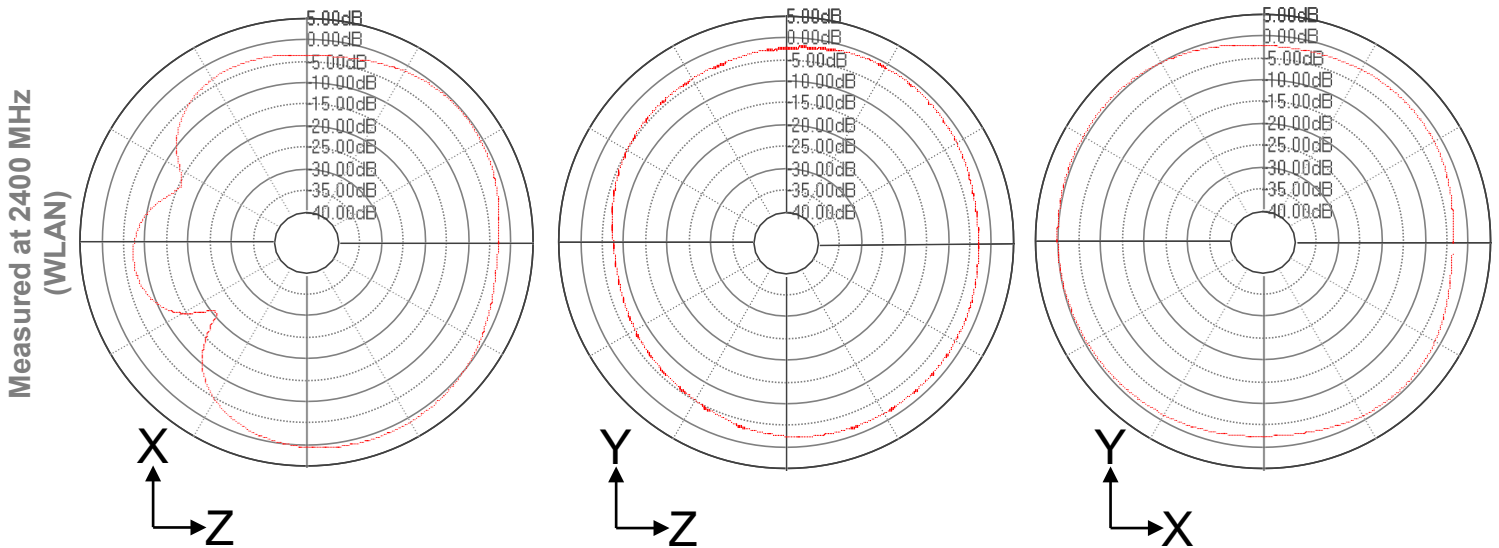
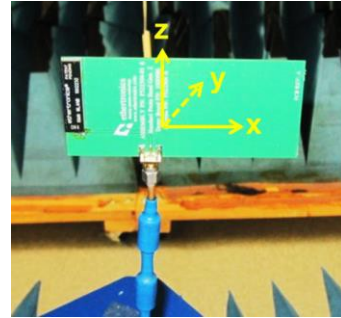
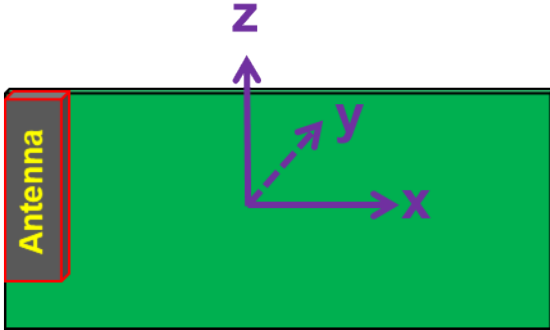

ISM / WLAN FR4 KYOCERA AVX Antenna Specifications
 KYOCERA AVX produces a wide variety of standard and custom antennas to meet user needs.

Antenna Layout

Typical layout dimensions (mm)

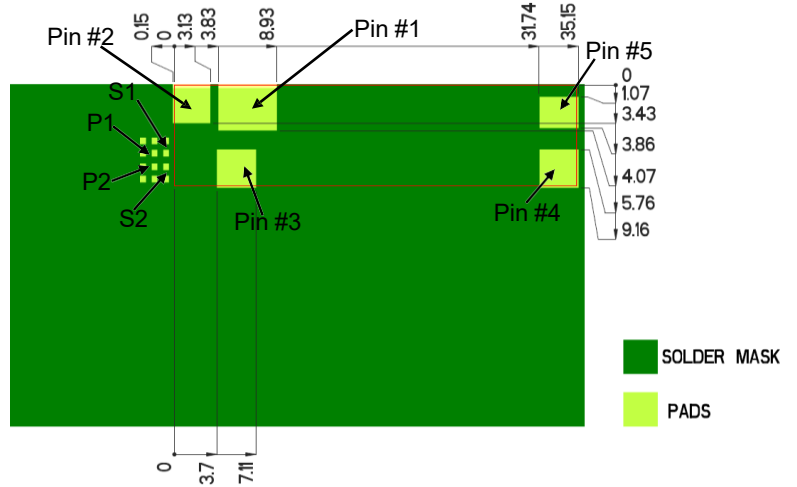
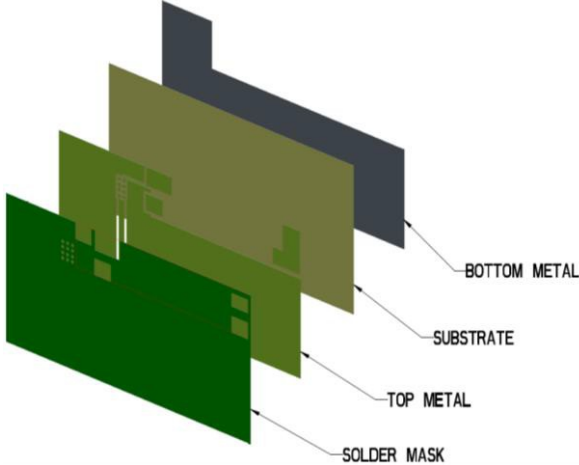

* VIAS: Diam. 0.2mm, (no vias on transmission lines).
 Via holes must be covered by solder mask

Pin Descriptions

Pin#	Description
1	Feed
2	Ground
3	Dummy Pad
4	Dummy Pad
5	Dummy Pad

Matching & Tuning Component Values

Component	Value	Tolerance
S1	2.0pF	±0.05pF
P1	N/A	N/A
P2	0.5pF	±0.05pF
S2	3.3nH	±0.1nH

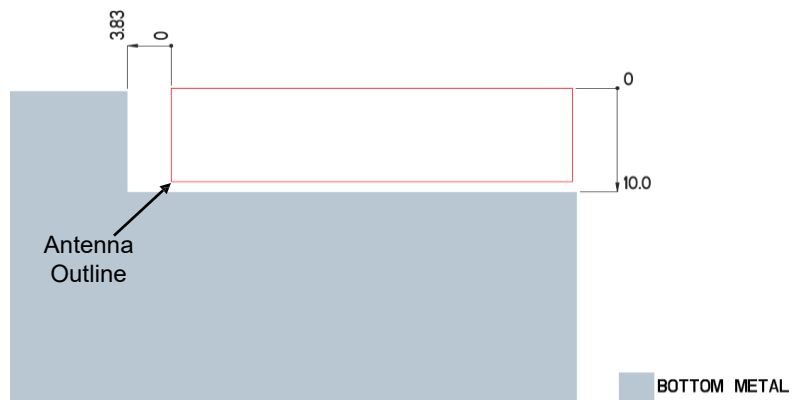
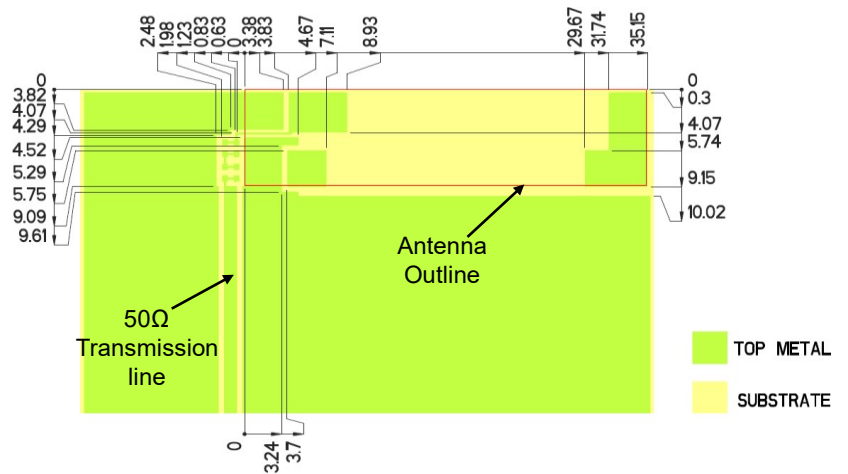

ISM / WLAN FR4 KYOCERA AVX Antenna Specifications
 KYOCERA AVX produces a wide variety of standard and custom antennas to meet user needs.

Antenna Matching Structure

Typical matching values on 50 x 110 mm PCB

Demo Board Front View

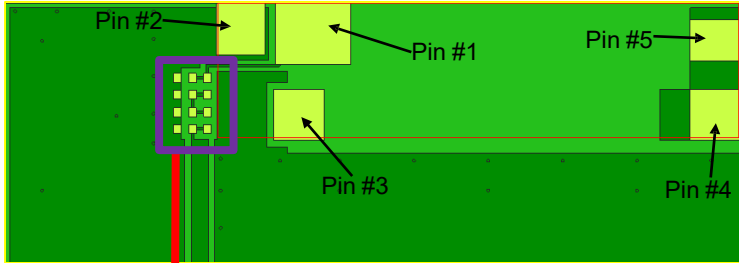

Antenna Matching

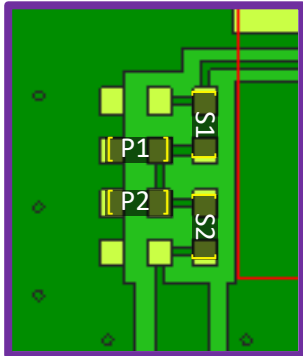

(Antenna Matching): pads are directly inline with the antenna feed trace.



Pin Descriptions

Pin#	Description
1	Feed
2	Ground
3	Dummy Pad
4	Dummy Pad
5	Dummy Pad

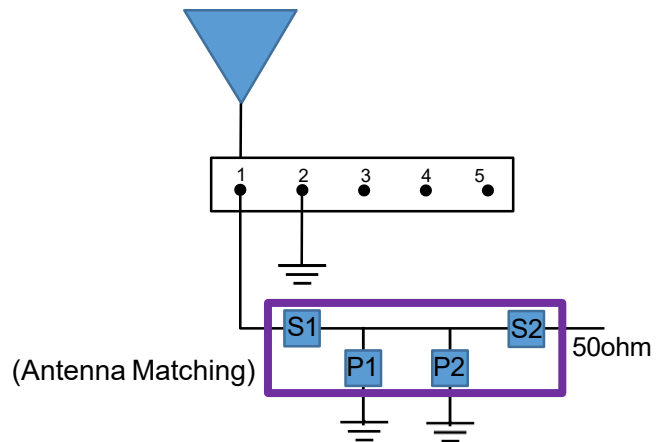

	S1	P1	P2	S2
Default Matching	2.0pF	N/A	0.5pF	3.3nH
Tolerance	±0.05pF	N/A	±0.05pF	± 0.1nH

ISM / WLAN FR4 KYOCERA AVX Antenna Specifications
KYOCERA AVX produces a wide variety of standard and custom antennas to meet user needs.

Antenna Demo Board (1002232)

Demo Board Front view (mm)

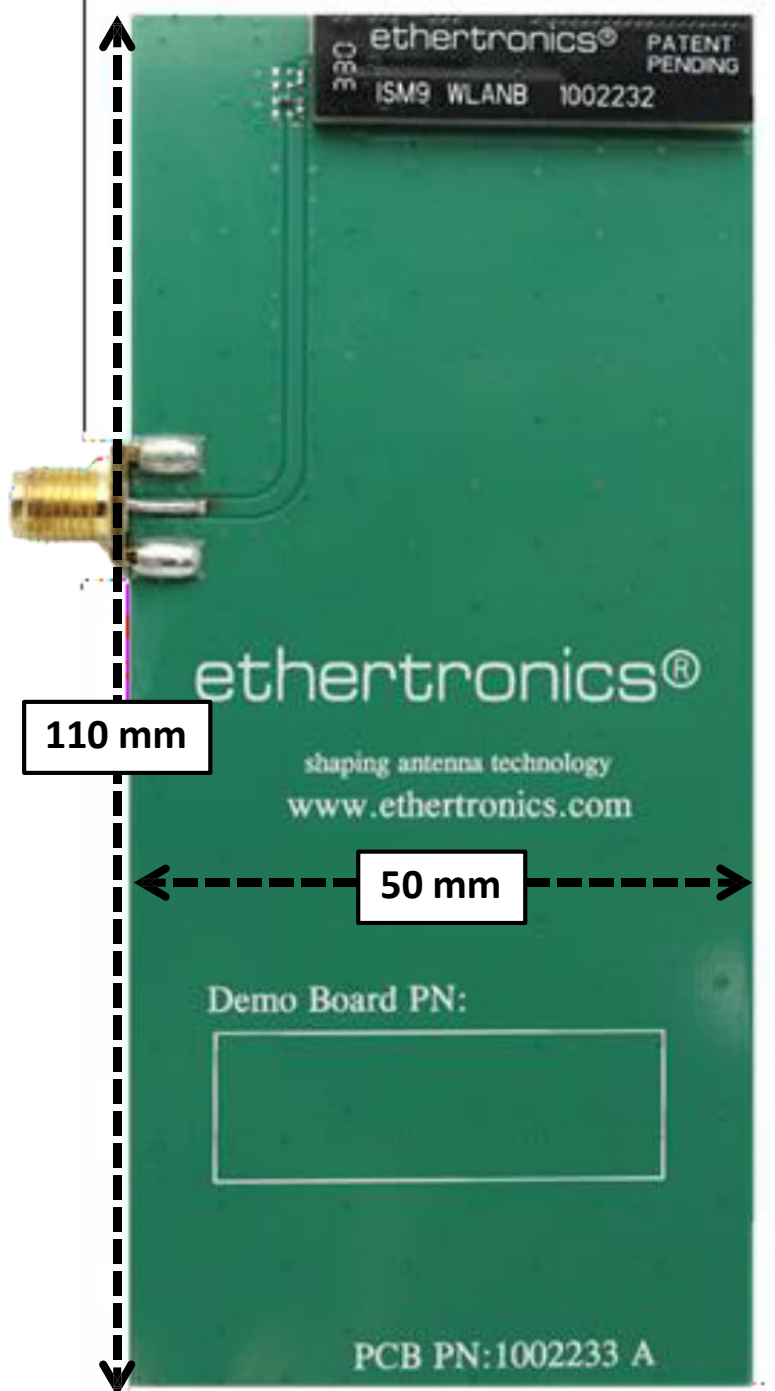

X-ON Electronics

Largest Supplier of Electrical and Electronic Components

Click to view similar products for [Antenna Development Tools](#) category:

Click to view products by [Kyocera AVX](#) manufacturer:

Other Similar products are found below :

[PCSD.06.A](#) [1002427-02](#) [1004796-01](#) [YC0010AAEVB](#) [1001013-02](#) [1005454-01](#) [1004795-01](#) [1002436-01](#) [ACR1004A-EVB](#) [RAC00024-EVB](#) [RAC00245-EVB](#) [ACR1004GC-EVB](#) [W3012-K](#) [W3006-K](#) [SPD.25A](#) [74889100TB](#) [A10192-U1](#) [DTAD.01.A.50](#) [SR4C033-EVB-1](#) [AEK-LTE-CER](#) [IOT-K](#) [SR4W035-EVB-1](#) [W3010-K](#) [LORA-K](#) [ISM-K](#) [REFLECTOR-EVB-1](#) [ACAG0201-2450-EVB](#) [ACAG0301-15752450-EVB](#) [ACAG0301-1575-EVB](#) [ACAG0301-24505500-EVB](#) [ACAG0301-5500-EVB](#) [ACAG0801-2450-EVB](#) [ACAG1204-433-EVB](#) [ACAG1204-868-EVB](#) [ACAG1204-915-EVB](#) [ACAR0301-SW2-EVB](#) [ACAR3005-C2WB-EVB](#) [ACAR3005-S824-EVB](#) [ACAR3705-S698-EVB](#) [ACAR4008-S698-EVB](#) [ACR0301U-EVB](#) [ACR1504I3-EVB-A](#) [ACR1504I3-EVB-S](#) [ACR2005I4-EVB](#) [ACR4006X-EVB](#) [PRO-EB-450](#) [PRO-EB-453](#) [PRO-EB-472](#) [PRO-EB-476](#) [PRO-EB-550](#)