

Part No. 1003893FT

BT Tunable FPC 2.4 GHz Embedded Antenna

2.4 GHz

Supports: Wi-Fi applications, Agriculture, Automotive, Bluetooth, Zigbee, WLAN, Smart Home, Healthcare, Digital Signage

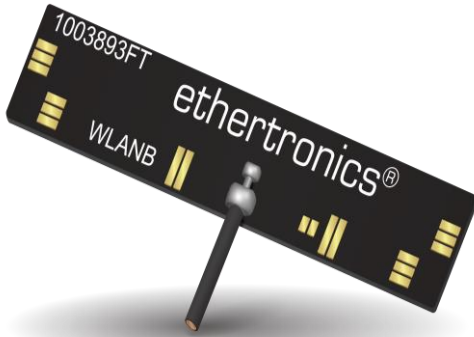

Ethertronics' WLAN antennas deliver on the key needs of device designers for higher functionality and performance in smaller/thinner designs. These innovative antennas provide compelling advantages for 2.4 GHz enabled devices.

Real-World Performance and Implementation

Antennas may look alike on the outside, but the important difference is inside. Other antennas may contain simple PIFA or monopole designs that interact with their surroundings, complicating layout or changing performance with use position. Ethertronics antennas utilize patented Isolated Magnetic Dipole (IMD) technology to deliver a unique size and performance combination. This antenna is also offered in PCB form under PN# 1003893PT.

BT Tunable FPC 2.4 GHz Embedded Antenna with cable

2.400 – 2.485 GHz

The 1003893FT is offered in many standard cable lengths ranging up to 200 mm. Ordering part number guide is located at end of document for selection ease.

KEY BENEFITS

Stay-in-Tune

Ethertronics antenna technology provides superior RF field containment, resulting in less interaction with surrounding components.

Quicker Time-to-Market

By optimizing antenna size, performance and emissions, customer and regulatory specifications are more easily met.

Reliability

Products are the latest RoHS version compliant

APPLICATIONS

- Embedded design
- Cellular, Headsets, Tablets
- Gateway, Access Point
- Handheld
- Telematics Tracking
- Healthcare M2M, Industrial devices
- Smart Grid
- OBD-II

Electrical Specifications

Typical Performance using 100 mm cable tested on PC-ABS

Frequency	2.400 – 2.485 GHz
Peak Gain	3.3 dBi
Average Efficiency	87%
VSWR Match	1.5:1 max
Feed Point Impedance	50 ohms unbalanced
Polarization	Linear
Power Handling	0.5 Watt CW

Mechanical Specifications

Ordering Part #	1003893FT-AA10L0100
Dimensions (mm)	40.0 x 8.0 x 0.12
Weight (grams)	0.7
Cable/Connector (mm)	Length: 100, Diameter: 1.13, Color: Black; u.FI compatible connector
Mounting	using 3M468 Adhesive
Packaging	PE bags

*Additional variations with different cable lengths, colors and connectors are available.



2.4 GHz Ethertronics' Embedded Antenna Specifications

Ethertronics produces a wide variety of standard and custom antennas to meet user needs.

Test Setup and Antenna Assembly

Measured in free space with PC/ABS loading and 100 mm cable

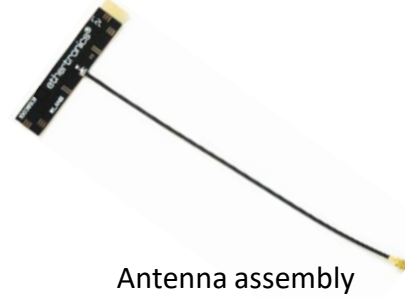
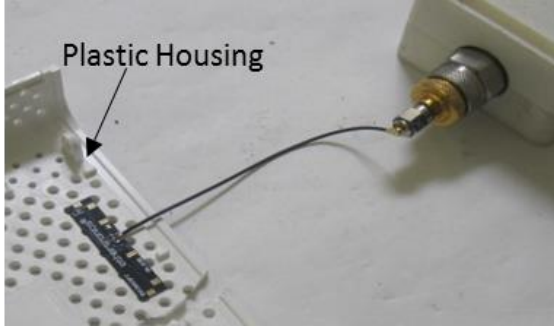

Antenna assembly

Typical VSWR and Efficiency Plots

Measured in free space with PC/ABS loading and 100 mm cable

VSWR

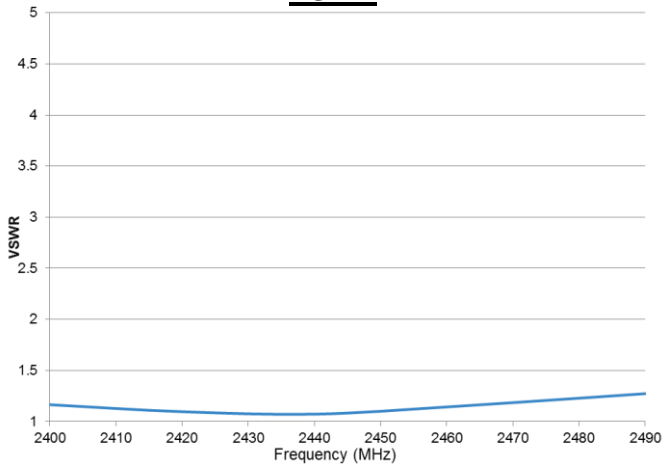

Efficiency

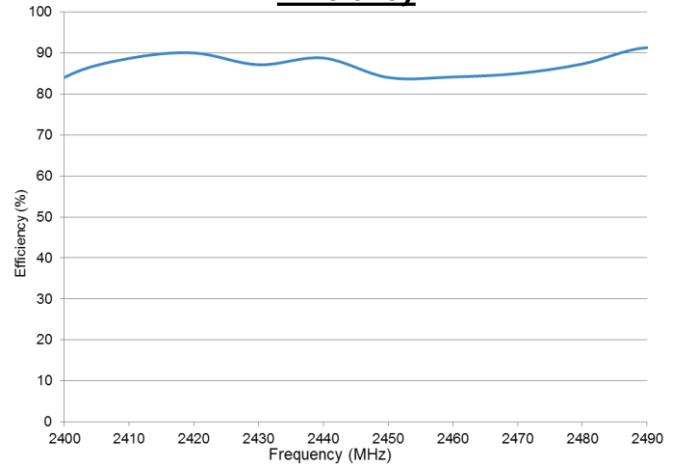

Antenna Radiation Patterns

Measured with PC/ABS loading and 100 mm cable

Typical Performance @ 2440 MHz

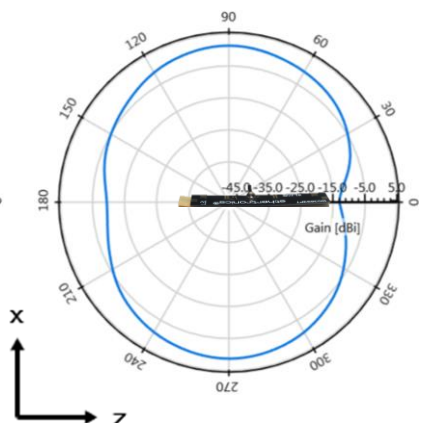
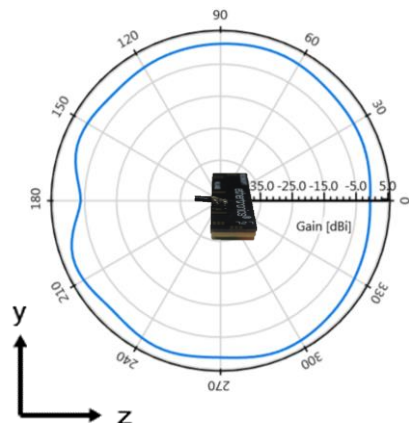
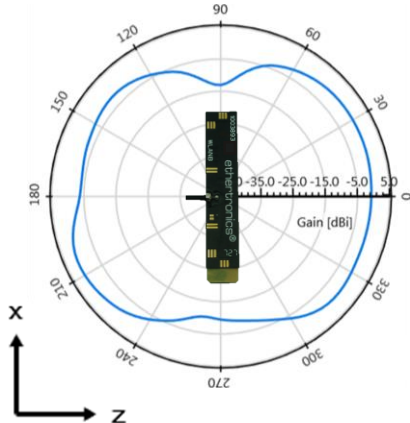
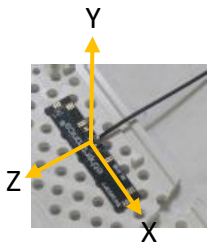



2.4 GHz Ethertronics' Embedded Antenna Specifications
Ethertronics produces a wide variety of standard and custom antennas to meet user needs.

Antenna Tuning Options

Typical Performance using 100 mm cable tested on PC-ABS



Ref Default: P1 ~ P8 Open

*This antenna has unique features enabling limited range RF tuning by leaving P1 ~ P8 connected by “solder bridge”. Refer to detailed tuning options below.

Options for Tuning: "2.4GHz (Lower)"

MODE	T1	T2	T3	T4
PADS	Connect: P1+P5	Connect: P1+P2+P5+P6	Connect: P3+P7	Connect: P3+P4+P7+P8
Outcome: (Ref: Default)	~20 MHz Shift low	~40 MHz Shift low	~20 MHz Shift low	~50 MHz Shift low

Antenna Tuning Procedure

This antenna has unique features enabling limited range RF tuning by adding a solder bridge in the designated area. Ease of tuning for any application on the fly with a soldering iron. Tuning optional if required.

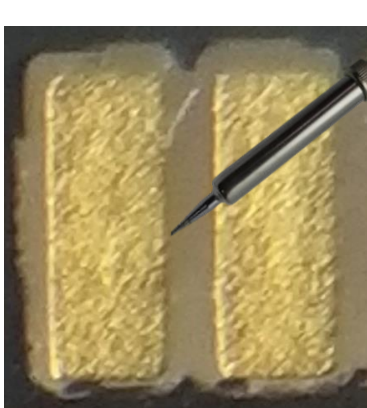

Antenna Tuning (Low)



*Add bridge of solder to connect pads for tuning



Filled Gap



2.4 GHz Ethertronics' Embedded Antenna Specifications
Ethertronics produces a wide variety of standard and custom antennas to meet user needs.

Mechanical Dimensions

For references only, in mm.

Part Number	A (mm)	B (mm)	C (mm)	D (mm)	Connector
1003893FT-AA10L0100	40.0 ± 0.3	8.0 ± 0.3	0.12	100.0 ± 3.0	u.FL compatible

*Height "C" of 0.12 mm includes FPC + adhesive thicknesses

*Connector shown in photo below is "Face Down"

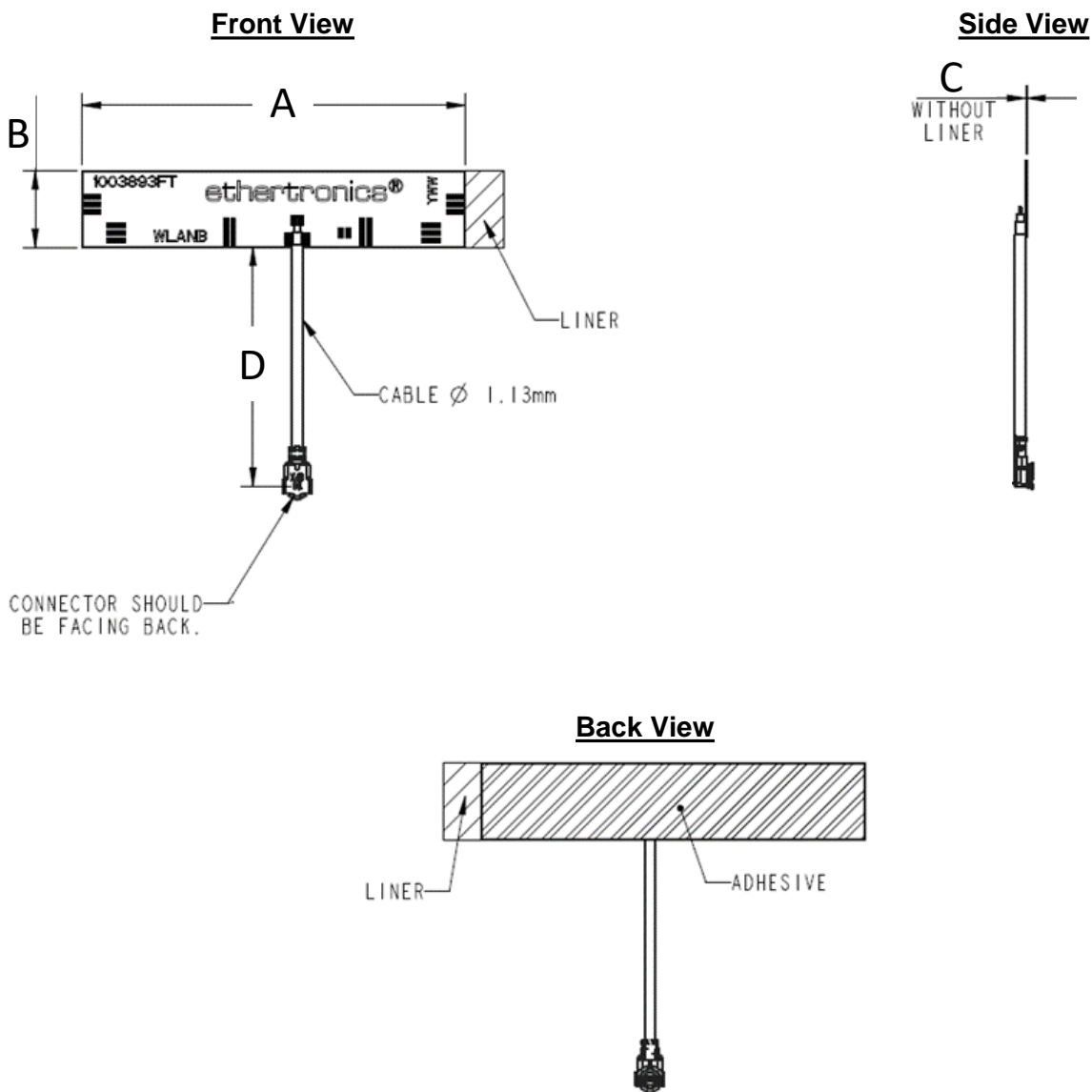



2.4 GHz Ethertronics' Embedded Antenna Specifications
Ethertronics produces a wide variety of standard and custom antennas to meet user needs.

Ordering Part Numbers

Typical antenna dimensions (mm)

Part Number	A (mm)	B (mm)	C (mm)	D (mm)	Connector
1003893FT-AA10L0025	40.0 ± 0.3	8.0 ± 0.3	0.12	25.0 ± 3.0	u.FL compatible
1003893FT-AA10L0050	40.0 ± 0.3	8.0 ± 0.3	0.12	50.0 ± 3.0	u.FL compatible
1003893FT-AA10L0075	40.0 ± 0.3	8.0 ± 0.3	0.12	75.0 ± 3.0	u.FL compatible
1003893FT-AA10L0100	40.0 ± 0.3	8.0 ± 0.3	0.12	100.0 ± 3.0	u.FL compatible
1003893FT-AA10L0150	40.0 ± 0.3	8.0 ± 0.3	0.12	150.0 ± 4.0	u.FL compatible
1003893FT-AA10L0200	40.0 ± 0.3	8.0 ± 0.3	0.12	200.0 ± 4.0	u.FL compatible

*Height "C" of 0.12 mm includes FPC + adhesive thicknesses

*Connector shown in photo below is "Face Down"

X-ON Electronics

Largest Supplier of Electrical and Electronic Components

Click to view similar products for [Antennas category](#):

Click to view products by [Kyocera AVX manufacturer](#):

Other Similar products are found below :

[GAN30084EU](#) [930-033-R](#) [GW17.07.0250E](#) [1513563-1](#) [EXE902SM](#) [APAMPG-117](#) [MAF94383](#) [W3908B0100](#) [W6102B0100](#) [YE572113-30RSMM](#) [108-00014-50](#) [66089-2406](#) [SPDA17RP918](#) [A09-F8NF-M](#) [A09-F5NF-M](#) [RGFRA1903041A1T](#) [W3593B0100](#) [W3921B0100](#) [SIMNA-868](#) [SIMNA-915](#) [SIMNA-433](#) [W1044](#) [W1049B090](#) [A75-001](#) [WTL2449CQ1-FRSMM](#) [CPL9C](#) [EXB148BN](#) [0600-00060](#) [TRA9020S3PBN-001](#) [GD5W-28P-NF](#) [MA9-7N](#) [GD53-25](#) [GD5W-21P-NF](#) [C37](#) [MAF94051](#) [MA9-5N](#) [EXD420PL](#) [B1322NR](#) [QWFTB120](#) [MAF94271](#) [MAF94300](#) [GPSMB301](#) [FG4403](#) [AO-AGSM-OM54](#) [5200232](#) [MIKROE-2349](#) [WCM.01.0111](#) [MIKROE-2393](#) [MIKROE-2352](#) [MIKROE-2350](#)