

Part No. 1004112

Broadband External LTE / Cellular Antenna

700 / 750 / 850 / 900 / 1800 / 1900 / 2100 / 2700 MHz

Supports: Broadband LTE (OCTA-BAND), LTE CAT-M, NB-IoT, SigFox, LoRa, Cellular LPWA, RPMA, Firstnet



Ethertronics' 1004112 antenna is designed to offer the best performances across LTE frequencies, regardless of the ground it is connected to. Its hinged connector and low profile design allows for diverse integration and functionality. Please refer to ordering guide for connector selection.

High Performance External LTE/Cellular Antenna

Low Band : 698-960 MHz

High Band: 1710-2155 MHz

High High Band: 2500-2700 MHz

The 1004112 broadband antenna offers full coverage for LTE bands 2, 4, 5, 7, 8, 12, 13, 14, 17, 25, 26 among others. Ethertronics antennas are versatile easy plug and play solutions for any major network carriers.

Electrical Specifications

Measured in Free space

| Frequency (MHz) | 690-960 | 1710-2200 | 2500-2700 |
|----------------------|------------------------|-----------|-----------|
| VSWR Match | < 2.5:1 | < 2.5:1 | < 2.5:1 |
| Average Efficiency | 65% | 60% | 78% |
| Peak Gain | 1.18 dBi | 4.5 dBi | 4.0 dBi |
| Polarization | Linear | | |
| Feed Point Impedance | 50 Ω unbalanced | | |

KEY BENEFITS

Greater Flexibility

Different connector options upon request. Small form factor and low profile. Independent of ground, the performances are maintained across design.

Quicker Time-to-Market

Standard antenna eliminates design fees, redesign cycle time and minimize risk associated with a customer solution. Quicker time to market.

Reliability

Comply with latest RoHS requirements

APPLICATIONS

- Medical applications
- Home automation
- Smart metering
- M2M, Industrial devices
- IoT
- Firstnet
- Automotive applications
- Healthcare Point of Sale
- Tracking
- NB-IoT
- Sigfox
- LoRa
- Cellular LPWA
- RPMA
- LTE CAT-M

Mechanical Specifications & Ordering Part Number

| Ordering Part # | 1004112-A001 | 1004112-B002 | 1004112-C003 |
|----------------------------|--------------------------|--------------------------|--------------------------|
| Dimensions (mm) | 218.2 x 27.2 x 13.8 | 227.1 x 27.2 x 14.5 | 218.2 x 27.2 x 13.8 |
| Mounting Type | External | External | External |
| Connector Type | SMA (MALE) 90° Hinged | TNC (MALE) 90° Hinged | SMA (MALE) 90° Hinged |
| Antenna Color | White | Black | Black |
| Weight (grams) | 31.5 | 43.2 | 31.5 |
| Operating Temperature (°C) | -30 to +70 | | |
| Max Power Handling (W) | 5 | | |

*Additional variations available in different colors and connectors



1004112 External LTE / Cellular performances
Ethertronics produces a wide variety of standard and custom antennas to meet user needs.

VSWR and Efficiency

Typical performance, measured in free space

Low Band VSWR

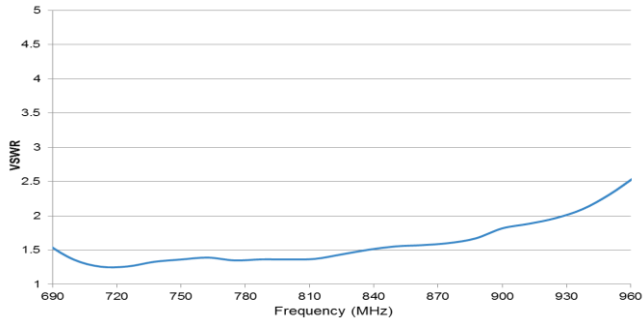

Low Band Efficiency

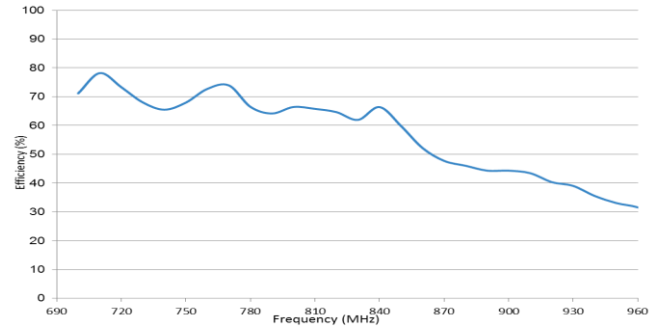

High Band VSWR

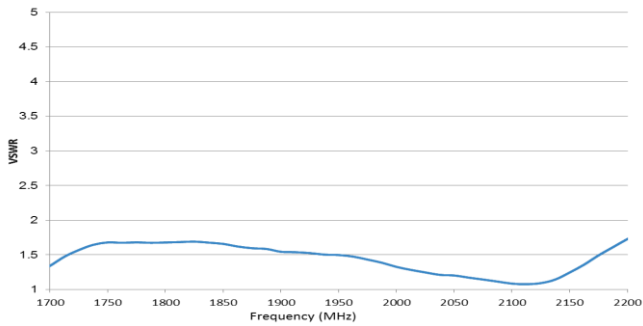

High Band Efficiency

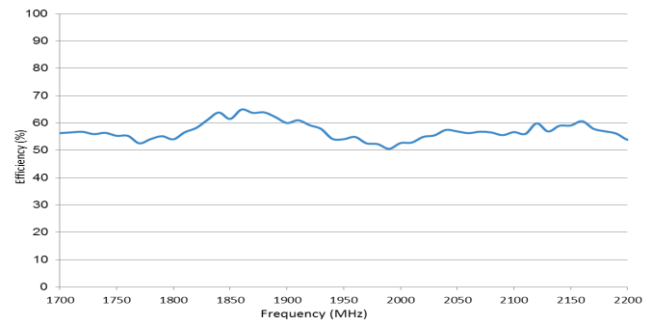

High High Band VSWR

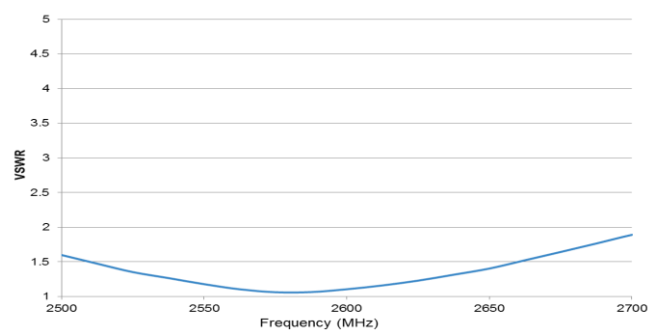

High High Band Efficiency

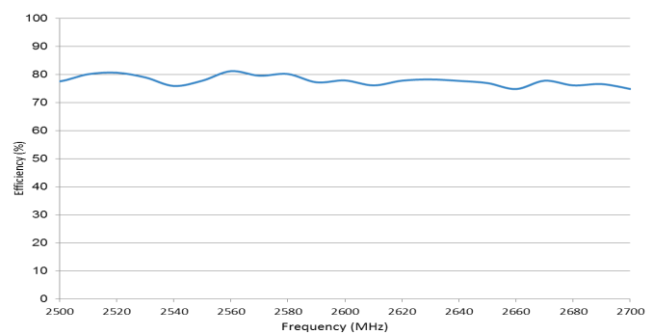



1004112 External LTE / Cellular performances
Ethertronics produces a wide variety of standard and custom antennas to meet user needs.

Antenna Radiation Patterns – Low / High Band

Typical performance, measured in free space

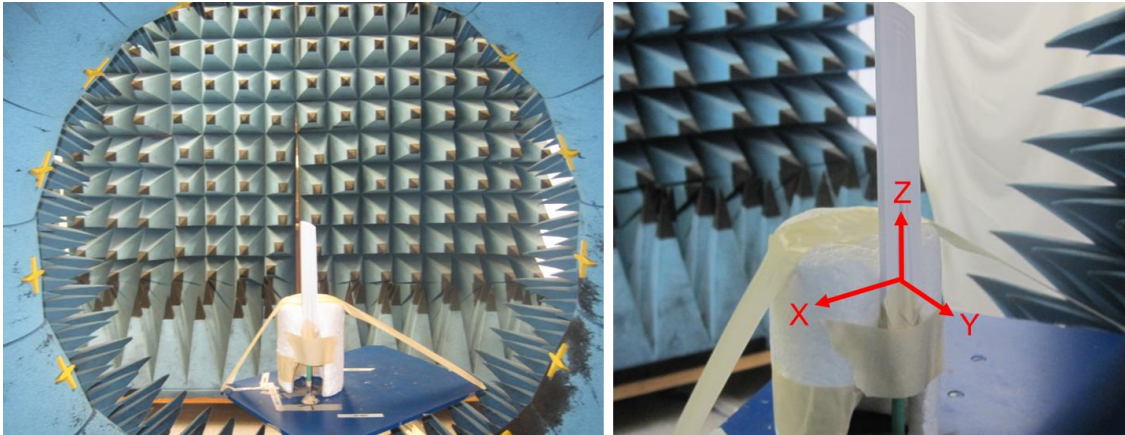

Low Band measured at 750 MHz

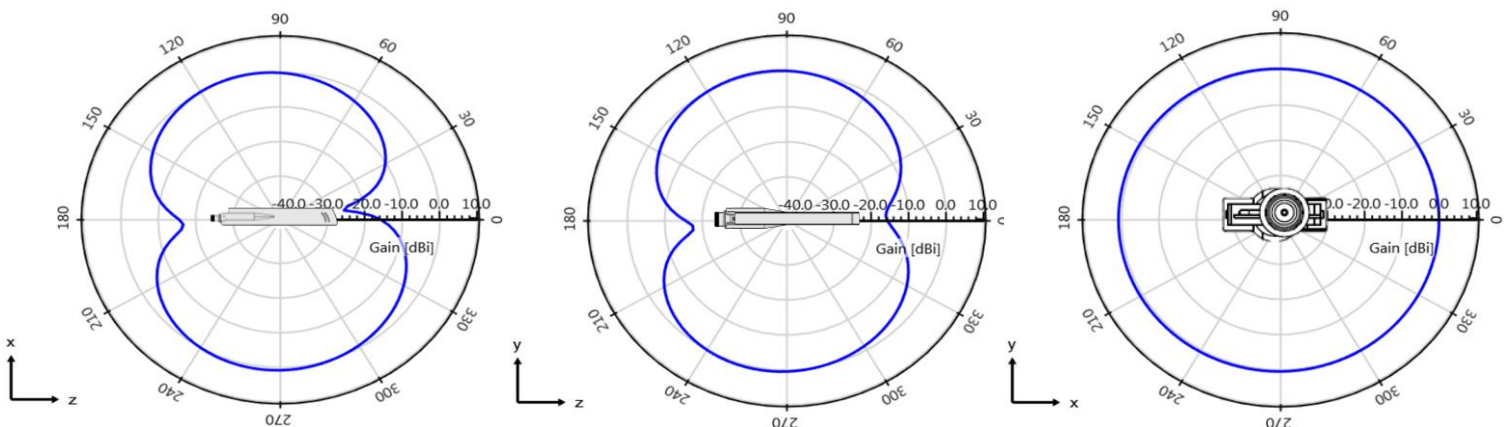

High Band measured at 1720 MHz

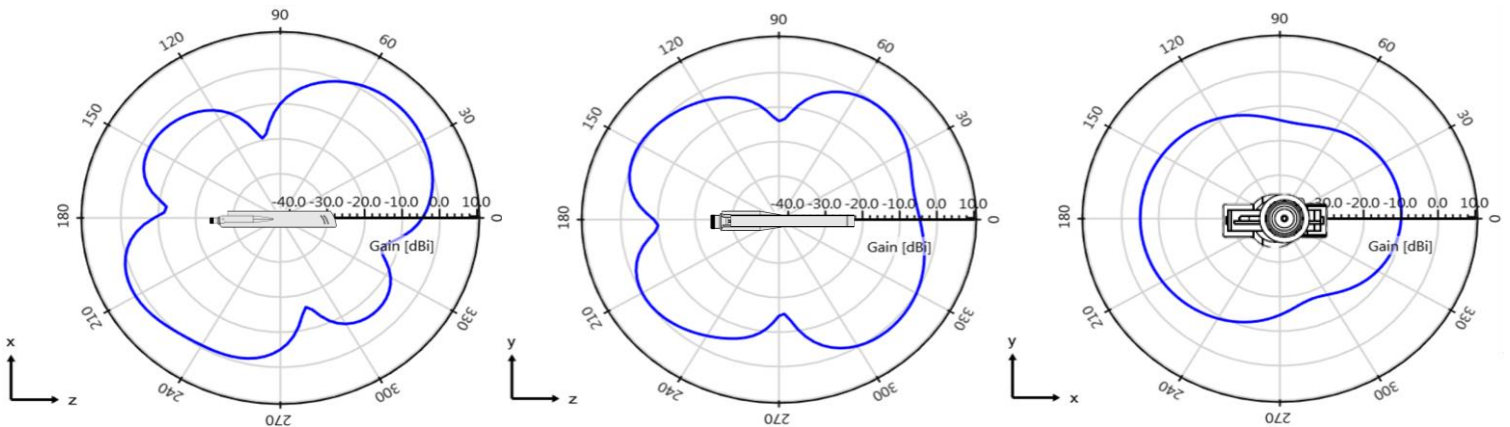



1004112 External LTE / Cellular performances
Ethertronics produces a wide variety of standard and custom antennas to meet user needs.

Antenna Radiation Patterns – High High Band

Typical performance, measured in free space

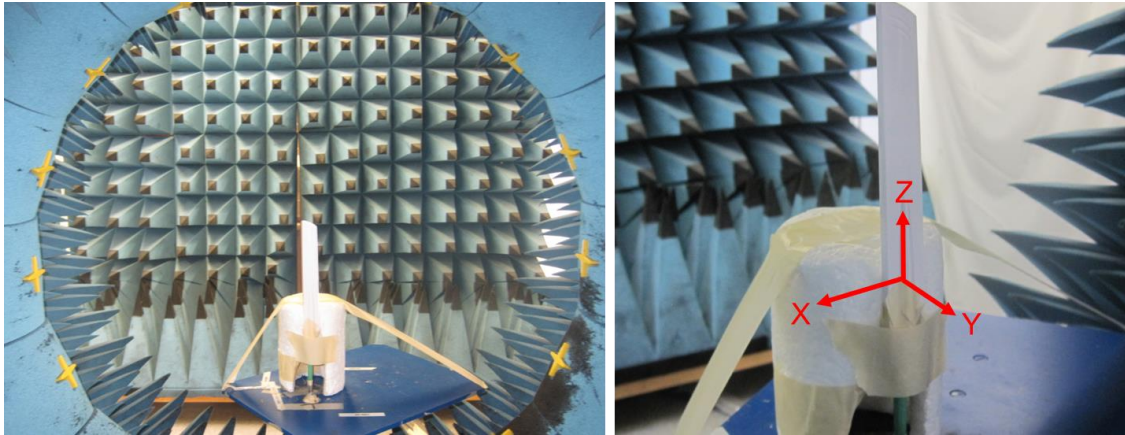

High High Band measured at 2550 MHz

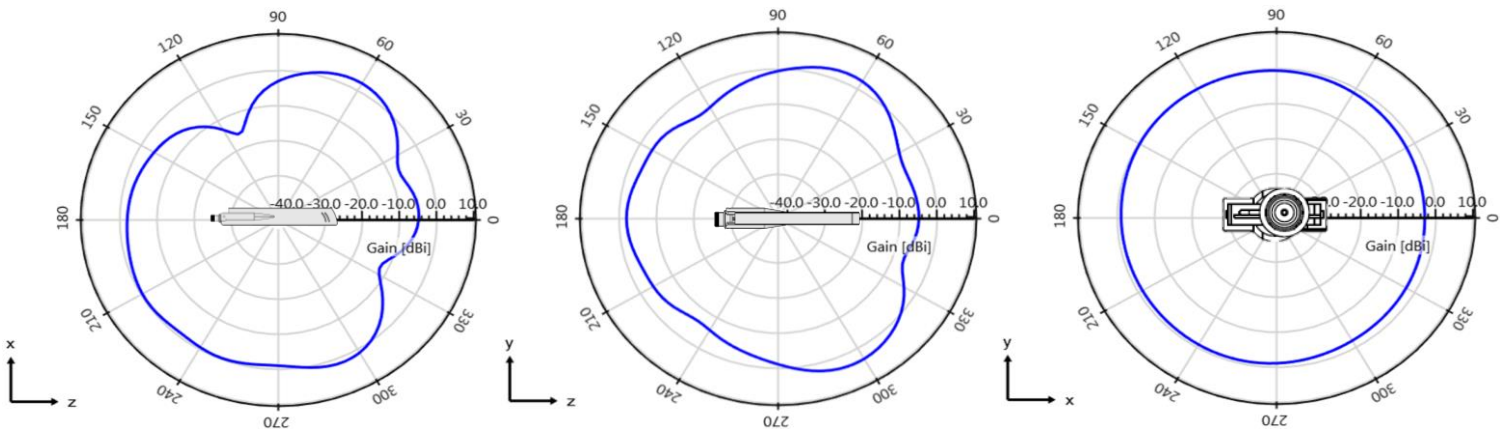



1004112 External LTE / Cellular performances

Ethertronics produces a wide variety of standard and custom antennas to meet user needs.

Mechanical Dimensions

Typical antenna dimensions (mm)

| Part Number | A (mm) | B (mm) | C (mm) | D (mm) | E (mm) | F (mm) | G (mm) | Connector |
|--------------|-------------|------------|------------|------------|-------------|------------|------------|------------|
| 1004112-A001 | 218.2 ± 3.0 | 27.2 ± 1.0 | 13.8 ± 1.0 | 10.1 ± 0.5 | 197.4 ± 3.0 | 27.4 ± 2.0 | 41.5 ± 2.0 | SMA (Male) |
| 1004112-B002 | 227.1 ± 3.0 | 27.2 ± 1.0 | 13.8 ± 1.0 | 14.5 ± 0.5 | 197.4 ± 3.0 | 36.4 ± 2.0 | 50.0 ± 2.0 | TNC (Male) |
| 1004112-C003 | 218.2 ± 3.0 | 27.2 ± 1.0 | 13.8 ± 1.0 | 10.1 ± 0.5 | 197.4 ± 3.0 | 27.4 ± 2.0 | 41.5 ± 2.0 | SMA (Male) |

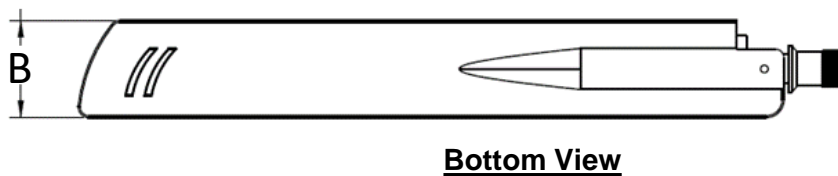
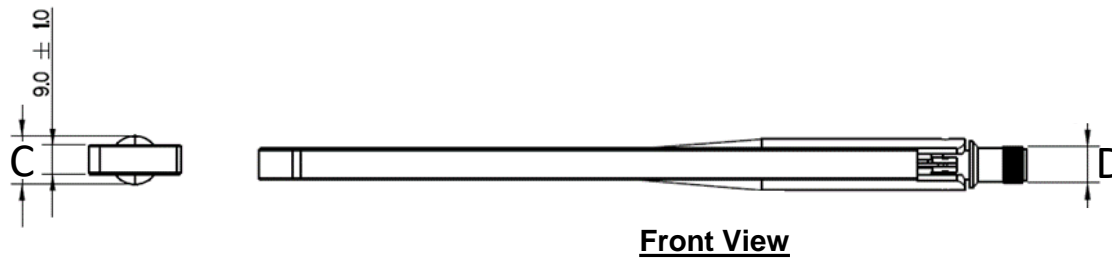
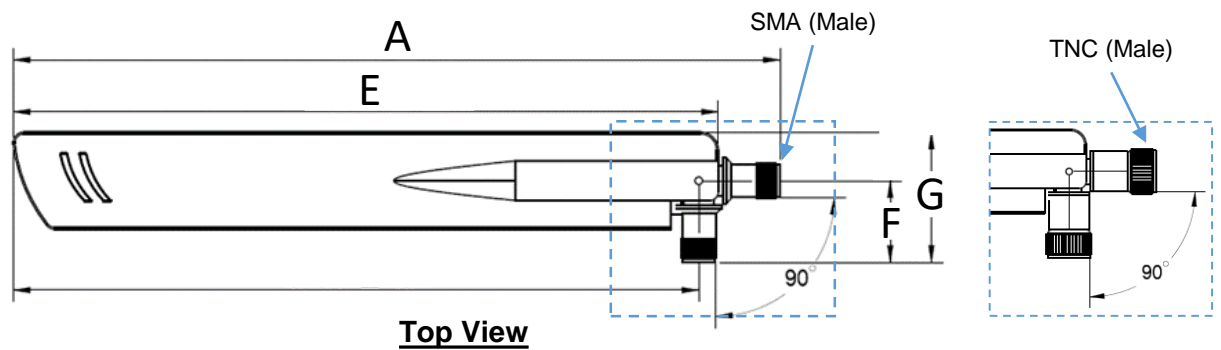

X-ON Electronics

Largest Supplier of Electrical and Electronic Components

Click to view similar products for [Antennas category](#):

Click to view products by [Kyocera AVX manufacturer](#):

Other Similar products are found below :

[GAN30084EU](#) [930-033-R](#) [GW17.07.0250E](#) [1513563-1](#) [EXE902SM](#) [APAMPG-117](#) [MAF94383](#) [W3908B0100](#) [W6102B0100](#) [YE572113-30RSMM](#) [108-00014-50](#) [66089-2406](#) [SPDA17RP918](#) [A09-F8NF-M](#) [A09-F5NF-M](#) [RGFRA1903041A1T](#) [W3593B0100](#) [W3921B0100](#) [SIMNA-868](#) [SIMNA-915](#) [SIMNA-433](#) [W1044](#) [W1049B090](#) [A75-001](#) [WTL2449CQ1-FRSMM](#) [CPL9C](#) [EXB148BN](#) [0600-00060](#) [TRA9020S3PBN-001](#) [GD5W-28P-NF](#) [MA9-7N](#) [GD53-25](#) [GD5W-21P-NF](#) [C37](#) [MAF94051](#) [MA9-5N](#) [EXD420PL](#) [B1322NR](#) [QWFTB120](#) [MAF94271](#) [MAF94300](#) [GPSMB301](#) [FG4403](#) [AO-AGSM-OM54](#) [5200232](#) [MIKROE-2349](#) [WCM.01.0111](#) [MIKROE-2393](#) [MIKROE-2352](#) [MIKROE-2350](#)