

Part No. 1004795-EC646-01

Antenna Band Switching Solution on Small EVB (LTE Antenna + Switch)

698-960 MHz; 1710-2170 MHz

Supports: Broadband LTE, 4G/5G, LTE CAT-M, NB-IoT, Cellular LPWA

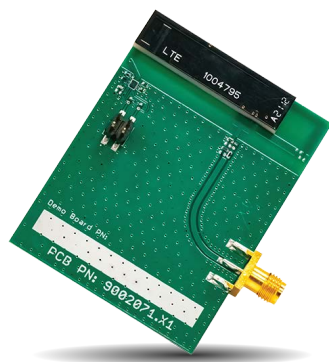

KYOCERA AVX Band Switching technology using standard products allows faster time-to-market. The Evaluation Board has a small size of 45.5 x 60 mm, which allows engineers test the antenna performance on a typical size of IoT devices, reducing the number of iterations and improving the accuracy.

The EVB uses the standard FR4 embedded LTE antenna 1004795 together with the chipset EC646 for band switching or aperture tuning.

Real-World Performance and Implementation

Antennas may look alike on the outside, but the important difference is inside. Other antennas may contain simple PIFA or monopole designs that interact with their surroundings, complicating layout or changing performance with use position. KYOCERA AVX antennas utilize patented Isolated Magnetic Dipole (IMD) technology to deliver a unique size and performance combination.

Band Switching Solution for small devices

Low Band: 698 – 960 MHz
High Band: 1710 - 2170 MHz

KEY BENEFITS

Stay-in-Tune

KYOCERA AVX antenna technology provides superior RF field containment, resulting in less interaction with surrounding components.

Quicker Time-to-Market

By optimizing antenna size, performance and emissions, customer and regulatory specifications are more easily met.

Reliability

Products are the latest RoHS version compliant.

APPLICATIONS

- Embedded design
- Cellular, Headsets, Tablets
- Handheld
- Telematics
- Tracking
- Healthcare
- M2M, Industrial devices
- Smart Grid
- OBD-II

Electrical Specifications

Typical Performance using 45.5 x 60.0 mm PCB

Frequency (MHz)	RF1 (890-960)	RF2 (700-800)	RF3 (700-750 / 1710-2170)	RF4 (790-890)
Peak Gain (dBi)	-1.60	-1.69	-1.45 / 2.99	-0.28
Average Efficiency (%)	18	22	20 / 60	30
Return Loss (dB)	< -2.5 / -2.5			
Feed Point Impedance	50 ohms unbalanced			
Polarization	Linear			
Power Handling	2.0 Watt CW			

Mechanical Specifications & Ordering Part Number

Ordering Part #	1004795-EC646-01
Dimensions (mm)	45.5 x 60.0
Connector	SMA (female)
Weight (grams)	10.5
Storage Temperature/ Humidity (Sealed shipping package)	+5°C to +40°C 45~75%
Operating Temperature	-40°C to +85°C
Packaging	Trays

LTE Active Tuning Solution + switch KYOCERA AVX Demo Board Specifications
 KYOCERA AVX produces a wide variety of standard and custom antennas to meet user needs.

Antenna Matching Structure

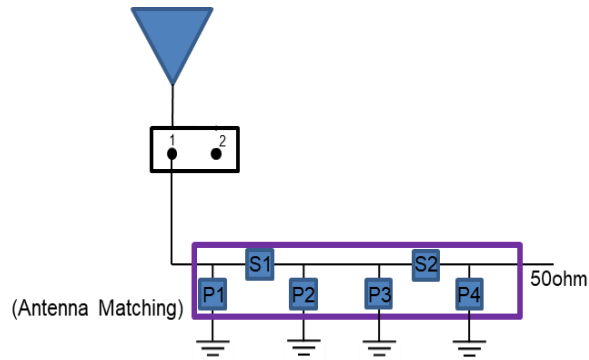
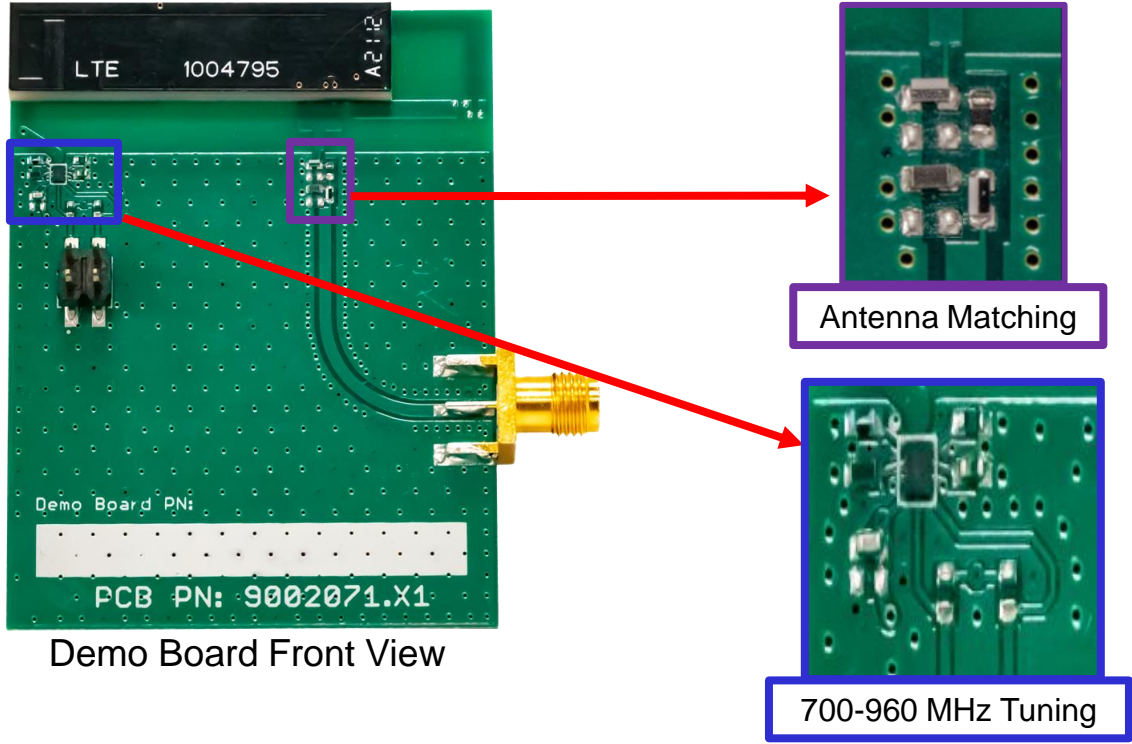

Matching	Value	PN
P1	5.6nH	L04025R6BHN
S1	0Ω	-
P2	NA	-
S2	2.2nH	L04022R2BHN
P3	1.5pF	04021J1R5PBS
P4	NA	-

LTE Active Tuning Solution + switch KYOCERA AVX Demo Board Specifications
 KYOCERA AVX produces a wide variety of standard and custom antennas to meet user needs.

Tuning Circuit (Low Band)

S0	S1	RF1	RF2	RF3	RF4
Low	Low	ON	OFF	OFF	OFF
Low	High	OFF	ON	OFF	OFF
High	Low	OFF	OFF	ON	OFF
High	High	OFF	OFF	OFF	ON

High and low state are controlled by connecting S0 or S1 with a 10kΩ resistor to either state “1” or state “0”.

State “1”: open connection across port.

State “0”: connection across port.

It is important to have 10kΩ to protect the EC646.

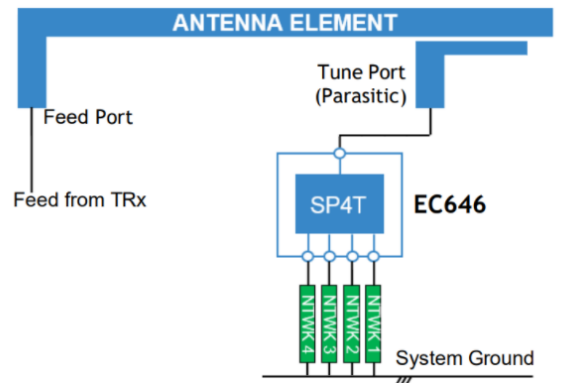
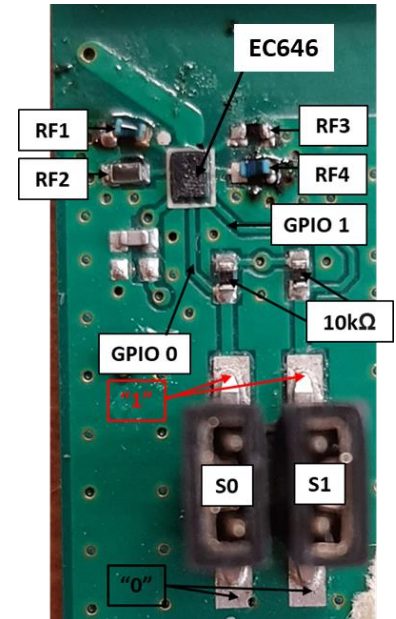

Tuning	Value	PN	Sub-band covered
RF1	16nH	LQW15AN16NG00D	890-960MHz
RF2	4.7pF	04025J4R7ABS	700-800MHz
RF3	1.8nH	L04021R8AHN	700-750MHz
RF4	40nH	LQW15AN40NG00D	790-890MHz

LTE Active Tuning Solution + switch KYOCERA AVX Demo Board Specifications
 KYOCERA AVX produces a wide variety of standard and custom antennas to meet user needs.

Return Loss, Efficiency and Peak Gain Plots

Typical Performance using 45.5x60.0 mm PCB

Low Band Return loss

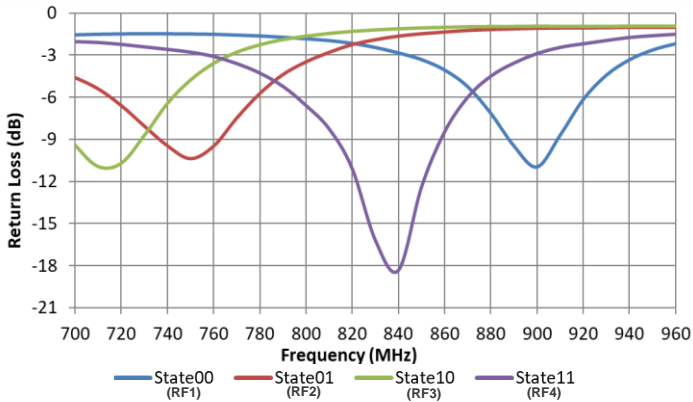

High Band Return Loss

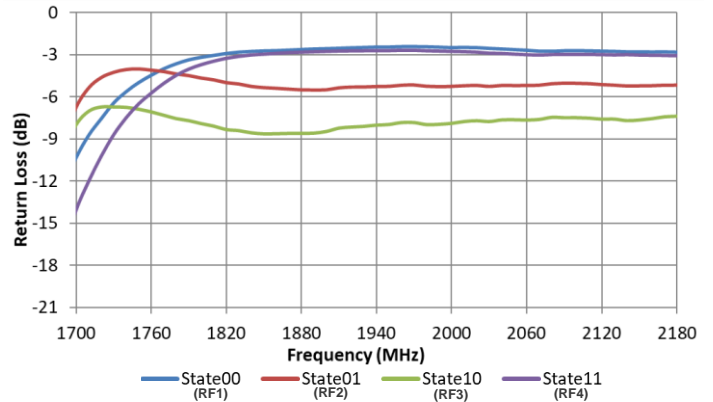

Low Band Efficiency

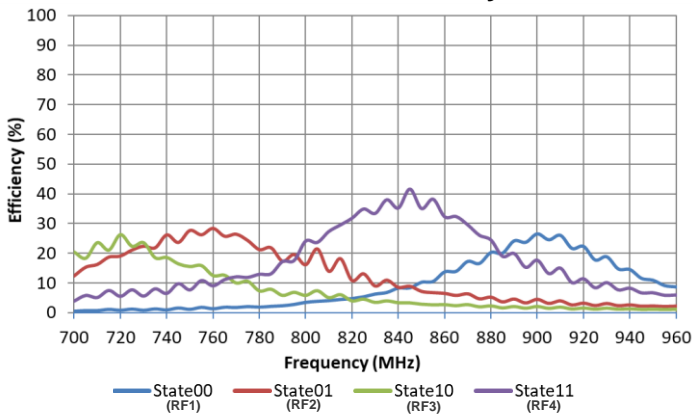

High Band Efficiency

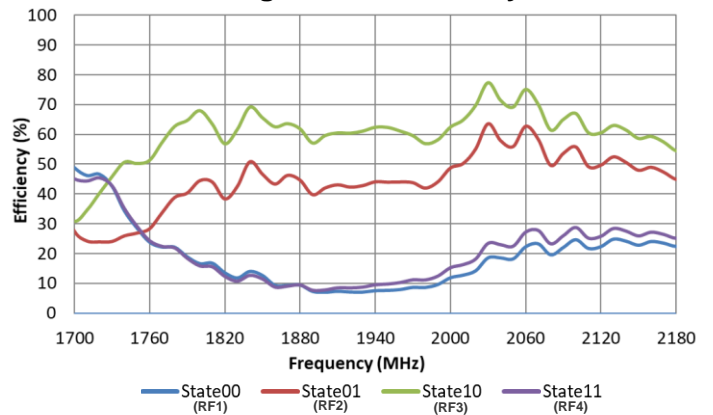

Low Band Peak Gain

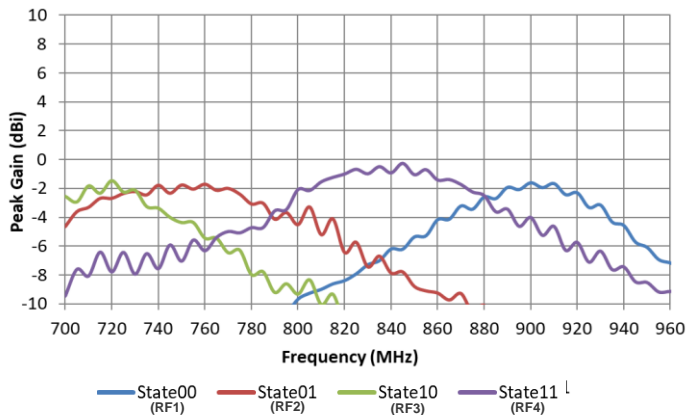

High Band Peak Gain

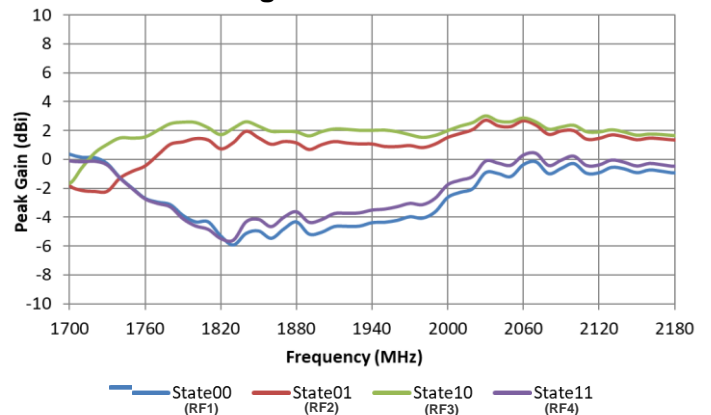

LTE Active Tuning Solution + switch KYOCERA AVX Demo Board Specifications
 KYOCERA AVX produces a wide variety of standard and custom antennas to meet user needs.

Antenna Radiation Patterns – Low Band

Typical Performance using 45.5x60.0 mm PCB

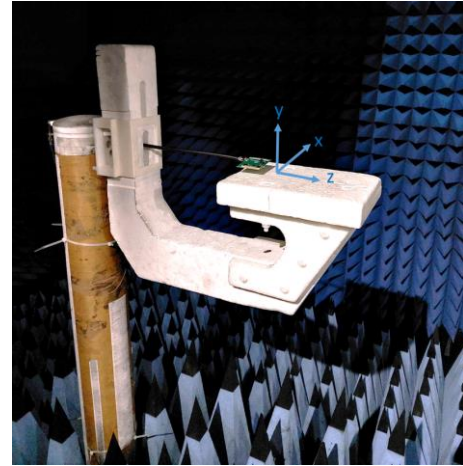
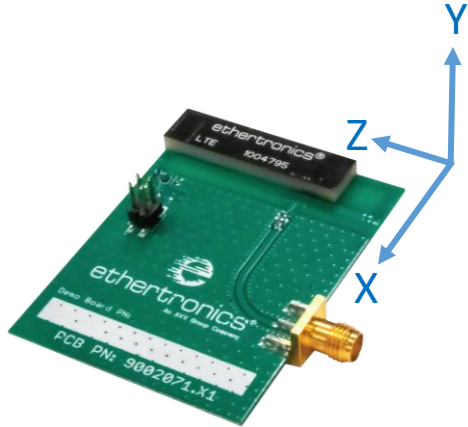

Low Band measured at 720 MHz

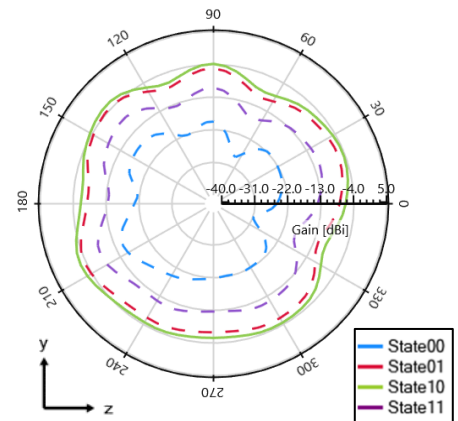
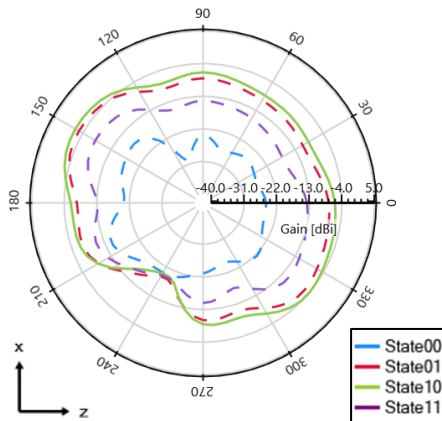
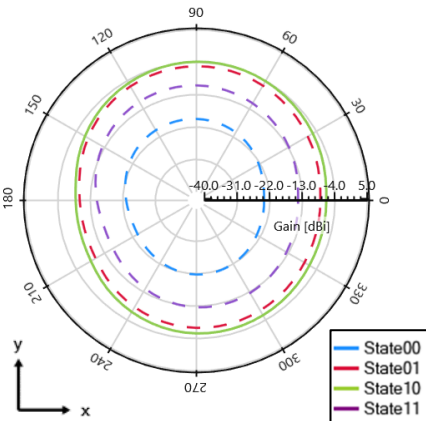

Low Band measured at 760 MHz

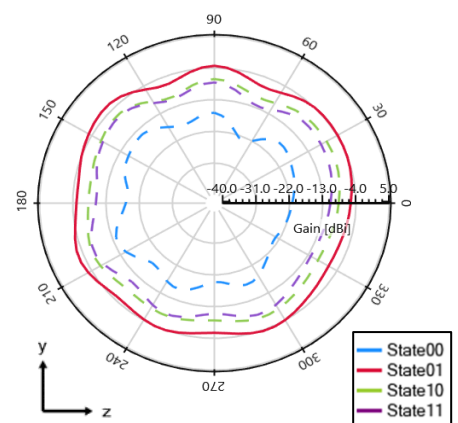
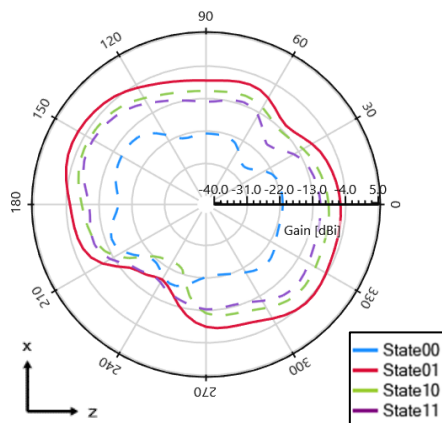
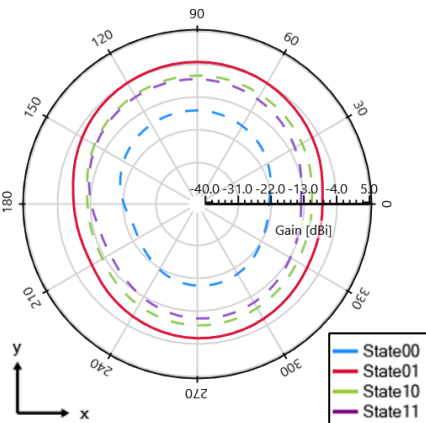

LTE Active Tuning Solution + switch KYOCERA AVX Demo Board Specifications
 KYOCERA AVX produces a wide variety of standard and custom antennas to meet user needs.

Antenna Radiation Patterns – Low Band cont.
 Typical Performance using 45.5x60.0 mm PCB

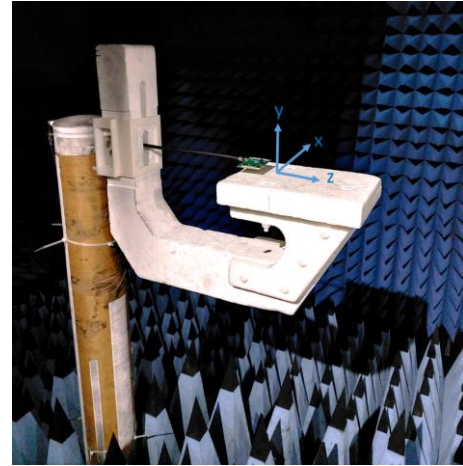
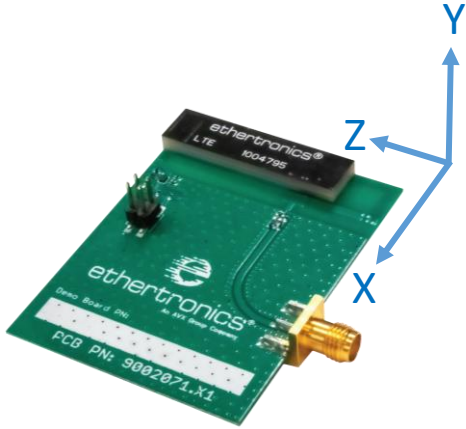

Low Band measured at 850 MHz

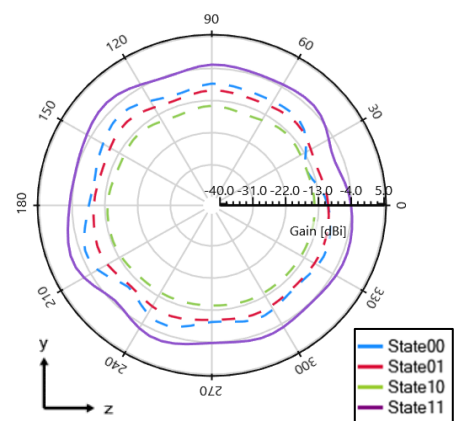
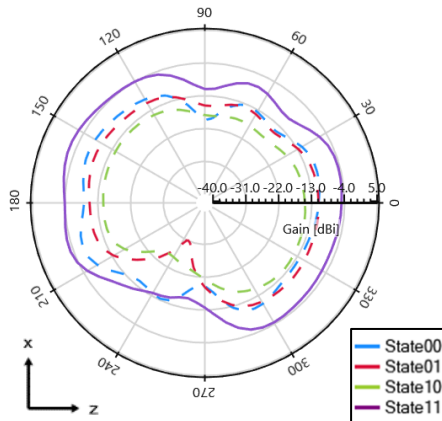
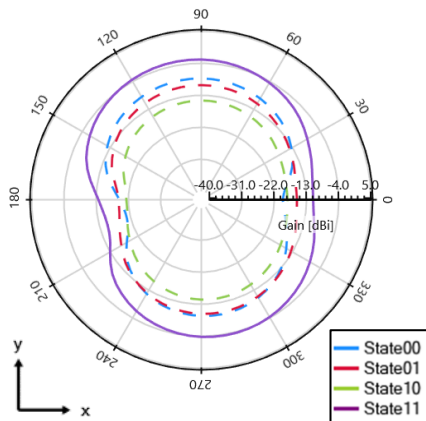

Low Band measured at 900 MHz

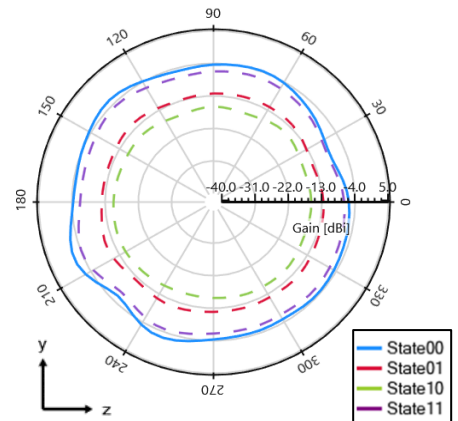
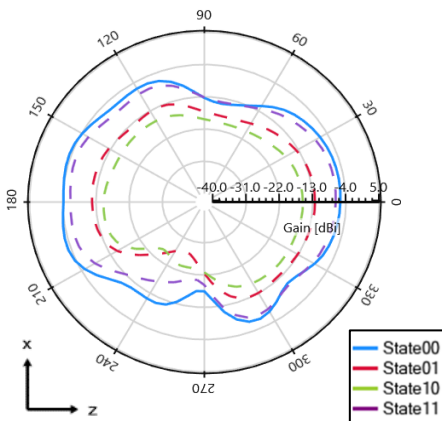
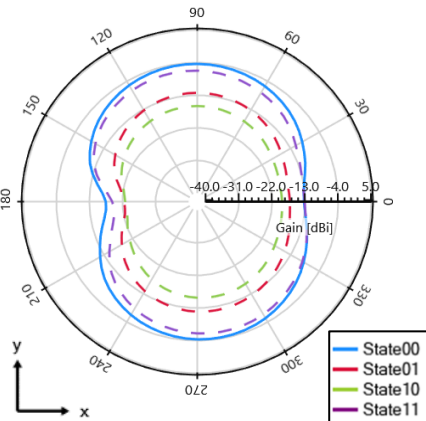

LTE Active Tuning Solution + switch KYOCERA AVX Demo Board Specifications
 KYOCERA AVX produces a wide variety of standard and custom antennas to meet user needs.

Antenna Radiation Patterns – High Band

Typical Performance using 45.5x60.0 mm PCB

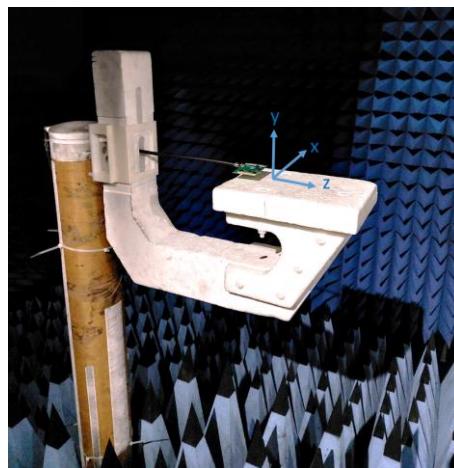
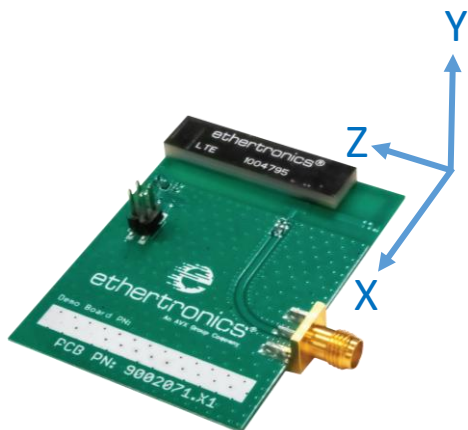

Low Band measured at 1850 MHz

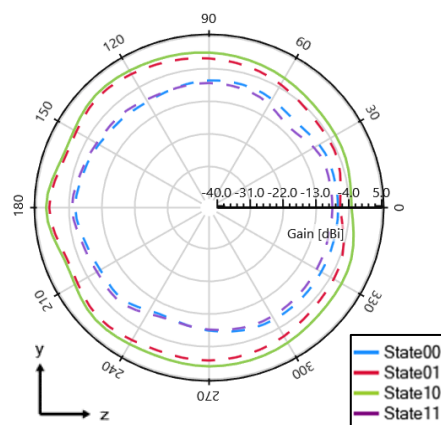
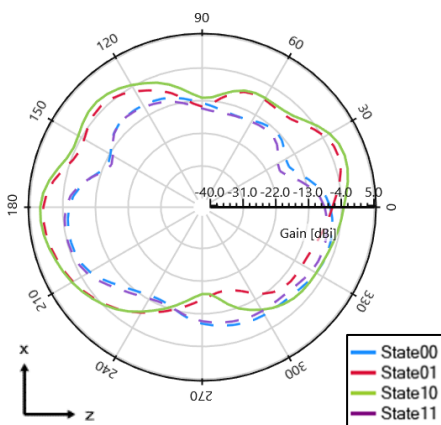
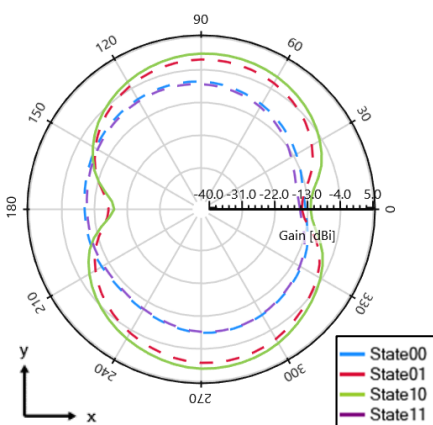

LTE Active Tuning Solution + switch KYOCERA AVX Demo Board Specifications
 KYOCERA AVX produces a wide variety of standard and custom antennas to meet user needs.

Mechanical Dimensions

Typical antenna dimensions mm.

Part Number	A	B	C	D
1004795-EC646-01	(45.5)	(60)	39.25	(0.80)

“() ” for reference only.

Top View

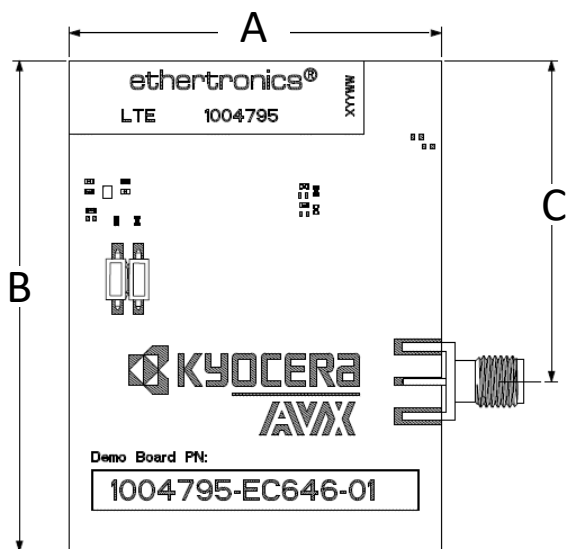

Side View

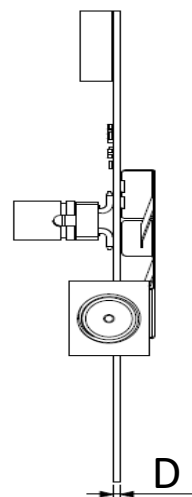

Bottom View

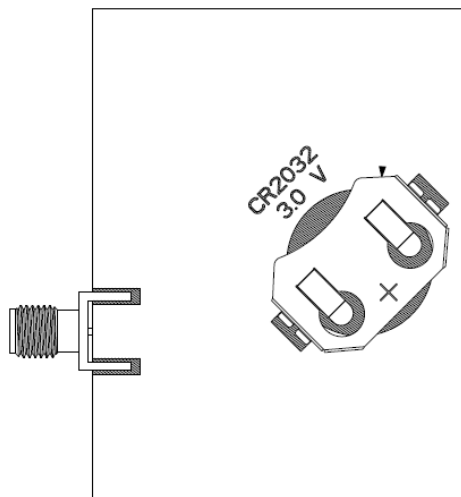

X-ON Electronics

Largest Supplier of Electrical and Electronic Components

Click to view similar products for [Antenna Development Tools](#) category:

Click to view products by [Kyocera AVX](#) manufacturer:

Other Similar products are found below :

[PCSD.06.A](#) [1002427-02](#) [1004796-01](#) [YC0010AAEVB](#) [1001013-02](#) [1005454-01](#) [1004795-01](#) [1002436-01](#) [ACR1004A-EVB](#) [RAC00024-EVB](#) [RAC00245-EVB](#) [ACR1004GC-EVB](#) [W3012-K](#) [W3006-K](#) [SPD.25A](#) [74889100TB](#) [A10192-U1](#) [DTAD.01.A.50](#) [SR4C033-EVB-1](#) [AEK-LTE-CER](#) [IOT-K](#) [SR4W035-EVB-1](#) [W3010-K](#) [LORA-K](#) [ISM-K](#) [REFLECTOR-EVB-1](#) [ACAG0201-2450-EVB](#) [ACAG0301-15752450-EVB](#) [ACAG0301-1575-EVB](#) [ACAG0301-24505500-EVB](#) [ACAG0301-5500-EVB](#) [ACAG0801-2450-EVB](#) [ACAG1204-433-EVB](#) [ACAG1204-868-EVB](#) [ACAG1204-915-EVB](#) [ACAR0301-SW2-EVB](#) [ACAR3005-C2WB-EVB](#) [ACAR3005-S824-EVB](#) [ACAR3705-S698-EVB](#) [ACAR4008-S698-EVB](#) [ACR0301U-EVB](#) [ACR1504I3-EVB-A](#) [ACR1504I3-EVB-S](#) [ACR2005I4-EVB](#) [ACR4006X-EVB](#) [PRO-EB-450](#) [PRO-EB-453](#) [PRO-EB-472](#) [PRO-EB-476](#) [PRO-EB-550](#)