

# Female Style 1/2 R High Temperature

## Series 8577 – 3 rows (3 x 16) Inverted



Contact Design and Termination Length	Number of Contacts	Loading Description	Part Number Performance classes according to DIN 41612	
			II	I
0.6 x 0.6 mm Post Profile 3.0 mm (Y) Right Angled	48	a + b + c fully loaded	20 8577 048 002 025	20 8577 048 002 049
	32	a + c fully loaded	20 8577 048 002 026	20 8577 048 002 050
	16	a + c even loading	20 8577 048 002 033	20 8577 048 002 057
	16	a loading only	20 8577 048 002 027	20 8577 048 002 051

NB: Alternative Prefix Variations Available: 26, please refer to Page 10.  
 Additional Plating & Loading Variations: Please contact your local AVX sales office or distributor.

### LOADING DESCRIPTION

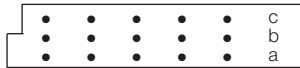

48 contacts, rows a + b + c fully loaded

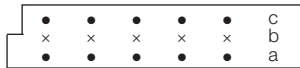

32 contacts, rows a + c fully loaded



16 contacts, rows a + c even loading

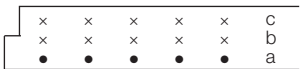

16 contacts, rows a loading only

### DIMENSIONS

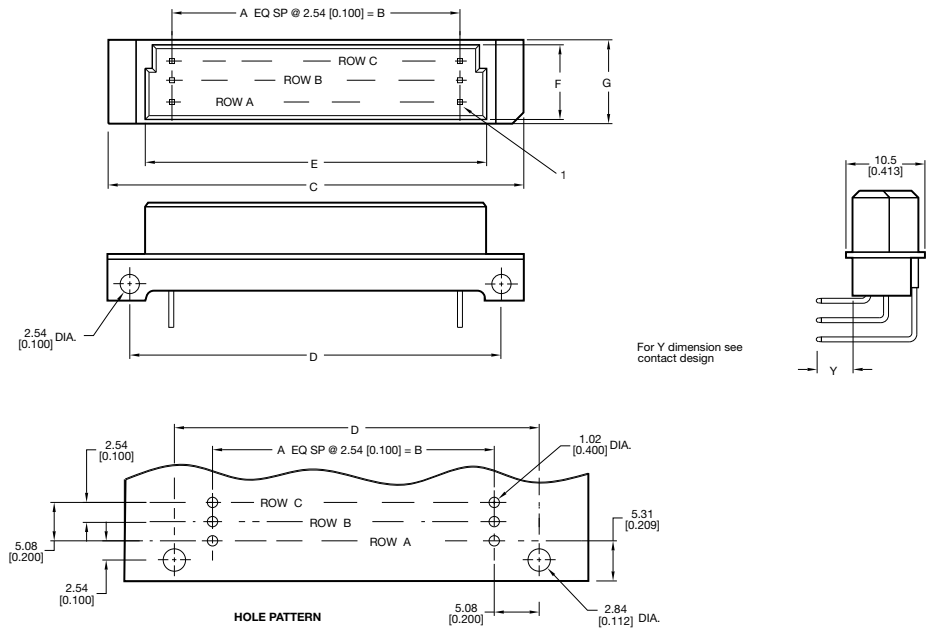

Unit: millimeters (inches)

No. Contact Positions	Contact Rows	A	B	C	D	E	F	G
48	3 (3 x 16)	15	38.10 (1.500)	53.90 (2.122)	48.26 (1.900)	44.30 (1.744)	8.48 (0.334)	10.50 (0.413)

# Male Style 1/2 R High Temperature



## Series 8577 – 3 rows (3 x 16) Inverted



Contact Design and Termination Length	Number of Contacts	Loading Description	Part Number Performance classes according to DIN 41612	
			II	I
2.9 mm (Y) Straight	48	a + b + c fully loaded	10 8577 048 001 025	10 8577 048 001 049
	32	a + c fully loaded	10 8577 048 001 026	10 8577 048 001 050
	16	a + c even loading	10 8577 048 001 033	10 8577 048 001 057
	16	a loading only	10 8577 048 001 027	10 8577 048 001 051
	46 + 2	fully loaded + ground	10 8577 048 101 025	10 8577 048 101 049
4.5 mm (Y) Straight	48	a + b + c fully loaded	10 8577 048 002 025	10 8577 048 002 049
	32	a + c fully loaded	10 8577 048 002 026	10 8577 048 002 050
	16	a + c even loading	10 8577 048 002 033	10 8577 048 002 057
	16	a loading only	10 8577 048 002 027	10 8577 048 002 051
	46 + 2	fully loaded + ground	10 8577 048 102 025	10 8577 048 102 049

NB: Alternative Prefix Variations Available: 16, please refer to Page 10.

Additional Plating & Loading Variations: Please contact your local AVX sales office or distributor.

### LOADING DESCRIPTION



48 contacts, rows a + b + c fully loaded

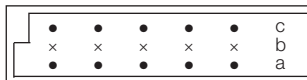

32 contacts, rows a + c fully loaded

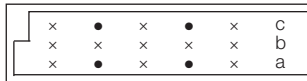

16 contacts, rows a + c even loading

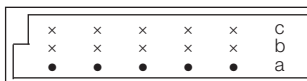

16 contacts, row a loading only

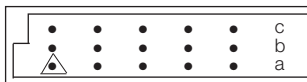

46 + 2 contacts, fully loaded with ground in A1 & A16

△ denotes ground pin

### DIMENSIONS

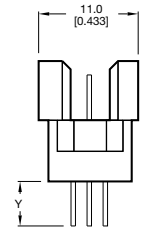
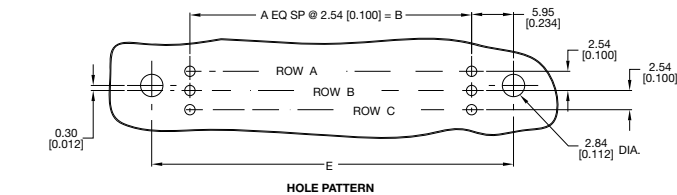
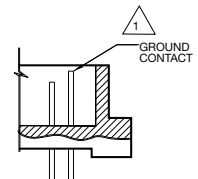
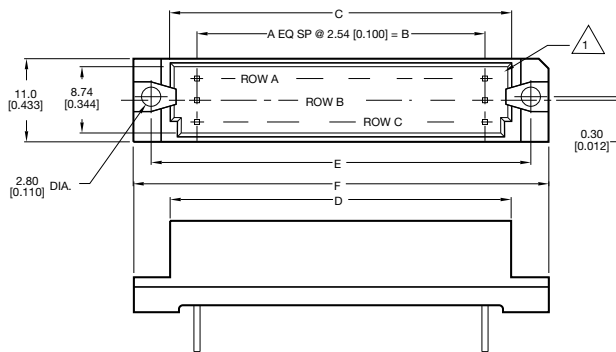

For Y dimension see contact design

Unit: millimeters (inches)

No. Contact Positions	Contact Rows	A	B	C	D	E	F
48	3 (3 x 16)	15	38.10 (1.500)	44.70 (1.760)	47.29 (1.862)	49.99 (1.968)	54.91 (2.162)

# Female Style R High Temperature



## Series 8577 – 3 rows (3 x 32) Inverted

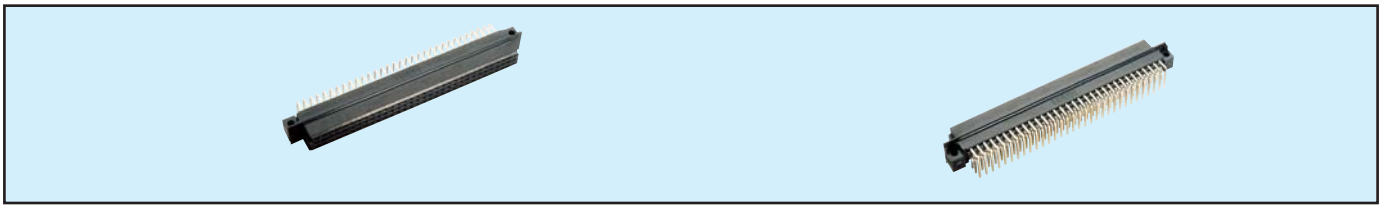

Contact Design and Termination Length	Number of Contacts	Loading Description	Part Number	
			Performance classes according to DIN 41612	
			II	I
0.6 x 0.6 mm Post Profile 3.0 mm (Y) Right Angled	96	a + b + c fully loaded	20 8577 096 002 025	20 8577 096 002 049
	64	a + c fully loaded	20 8577 096 002 026	20 8577 096 002 050
	32	a + c even loading	20 8577 096 002 033	20 8577 096 002 057
	32	a loading only	20 8577 096 002 027	20 8577 096 002 051

NB: Alternative Prefix Variations Available: 26, please refer to Page 10.

Additional Plating & Loading Variations: Please contact your local AVX sales office or distributor.

### LOADING DESCRIPTION



96 contacts, rows a + b + c fully loaded

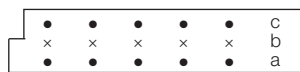

64 contacts, rows a + c fully loaded

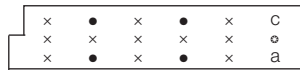

32 contacts, rows a + c even loading

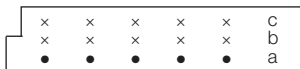

32 contacts, rows a loading only

### DIMENSIONS

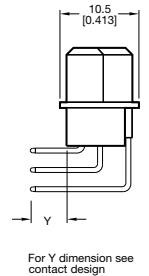
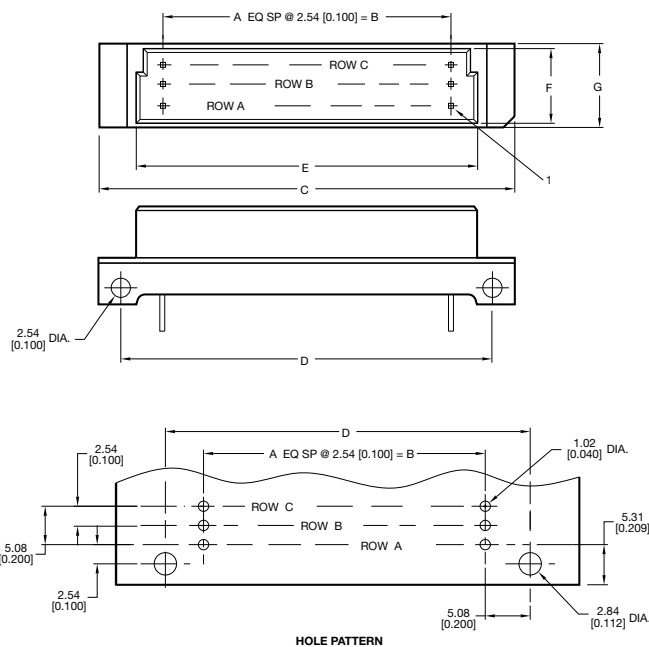

For Y dimension see contact design

Unit: millimeters (inches)

No. Contact Positions	Contact Rows	A	B	C	D	E	F	G
96	3 (3 x 32)	31	78.74 (3.100)	93.90 (3.697)	88.90 (3.500)	84.90 (3.343)	8.48 (0.334)	10.50 (0.413)

# Male Style R High Temperature



## Series 8577 – 3 rows (3 x 32) Inverted

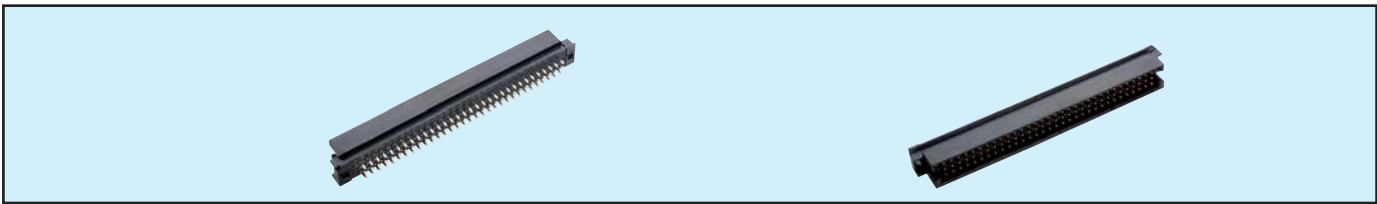

Contact Design and Termination Length	Number of Contacts	Loading Description	Part Number	
			Performance classes according to DIN 41612	
			II	I
2.9 mm (Y) Straight	96	a + b + c fully loaded	10 8577 096 001 025	10 8577 096 001 049
	64	a + c fully loaded	10 8577 096 001 026	10 8577 096 001 050
	32	a + c even loading	10 8577 096 001 033	10 8577 096 001 057
	32	a loading only	10 8577 096 001 027	10 8577 096 001 051
	46 + 2	fully loaded + ground	10 8577 096 101 025	10 8577 096 101 049
4.5 mm (Y) Straight	48	a + b + c fully loaded	10 8577 096 002 025	10 8577 096 002 049
	32	a + c fully loaded	10 8577 096 002 026	10 8577 096 002 050
	16	a + c even loading	10 8577 096 002 033	10 8577 096 002 057
	16	a loading only	10 8577 096 002 027	10 8577 096 002 051
	46 + 2	fully loaded + ground	10 8577 096 102 025	10 8577 096 102 049

NB: Alternative Prefix Variations Available: 16, please refer to Page 10.

Additional Plating & Loading Variations: Please contact your local AVX sales office or distributor.

### LOADING DESCRIPTION

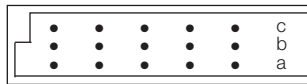

96 contacts, rows a + b + c fully loaded

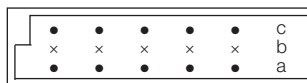

64 contacts, rows a + c fully loaded

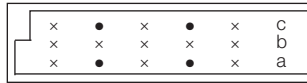

32 contacts, rows a + c even loading

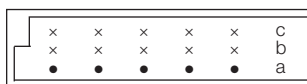

32 contacts, row a loading only

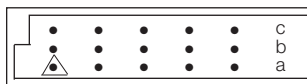

96 + 2 contacts, fully loaded with ground in A1 & A32

△ denotes ground pin

### DIMENSIONS

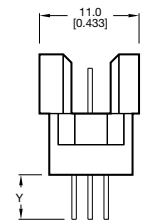
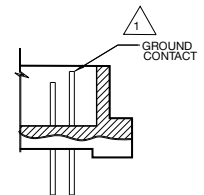
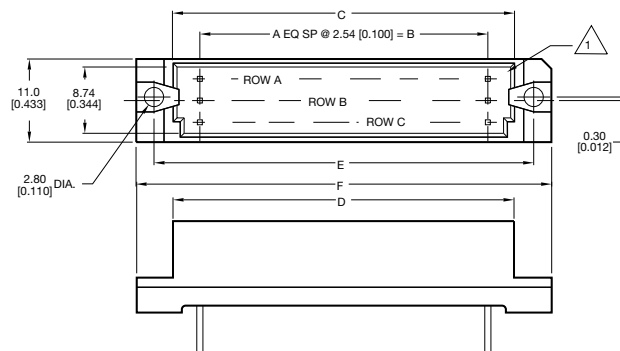

For Y dimension see contact design

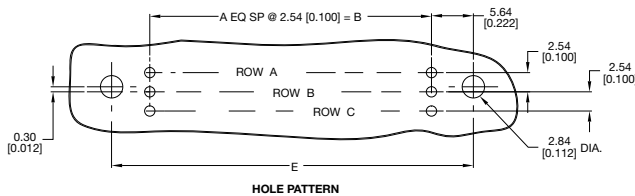

Unit: millimeters (inches)

No. Contact Positions	Contact Rows	A	B	C	D	E	F
96	3 (3 x 32)	31	78.74 (3.100)	85.29 (3.358)	87.91 (3.461)	90.00 (3.543)	94.89 (3.736)



# Female Style R Expanded High Temperature Series 8577 – 4 rows (4 x 32) Inverted

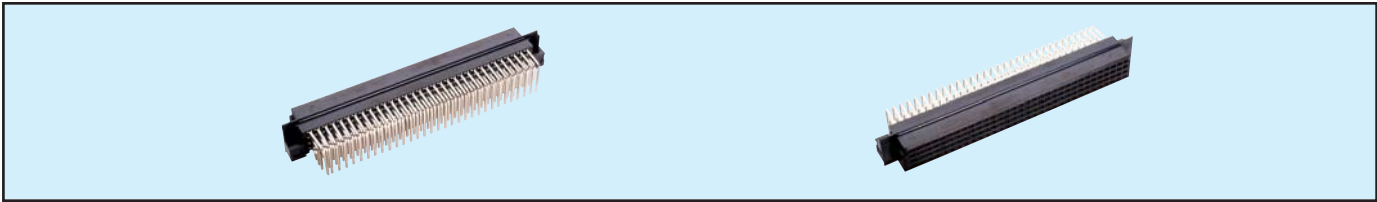

Contact Design and Termination Length	Number of Contacts	Loading Description	Part Number Performance classes according to DIN 41612	
			II	I
0.6 x 0.6 mm Post Profile 3.0 mm (Y) Right Angled	128	a + b + c + d fully loaded	20 8577 128 002 025	20 8577 128 002 049

NB: Alternative Prefix Variations Available: 26, please refer to Page 10.  
Additional Plating & Loading Variations: Please contact your local AVX sales office or distributor.

## LOADING DESCRIPTION

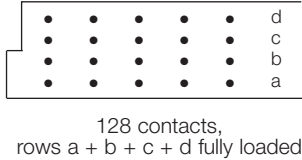

## DIMENSIONS

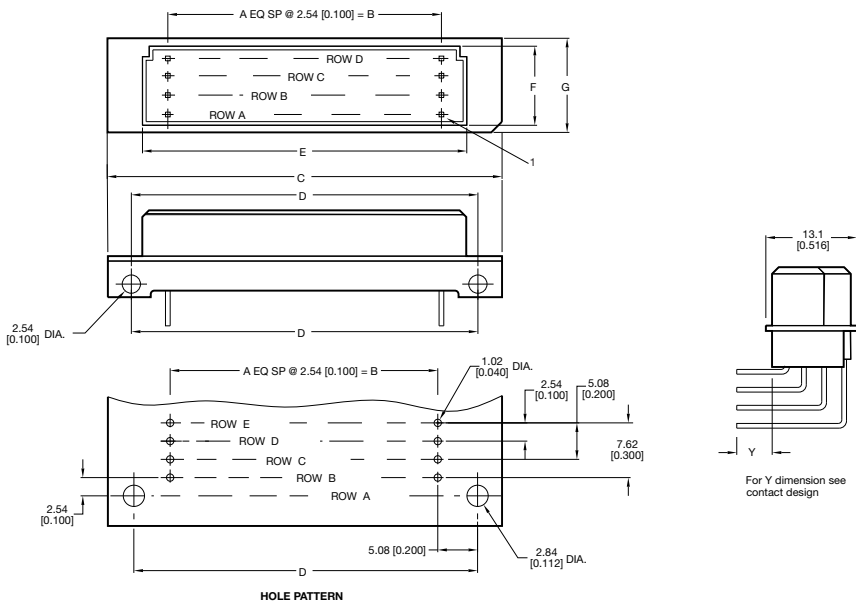

Unit: millimeters (inches)

No. Contact Positions	Contact Rows	A	B	C	D	E	F	G
128	4 (4 x 32)	31	78.74 (3.100)	93.90 (3.697)	88.90 (3.500)	84.90 (3.343)	11.10 (0.437)	13.10 (0.516)

# Female Style R Expanded High Temperature Series 8577 – 3 rows (3 x 50) Inverted

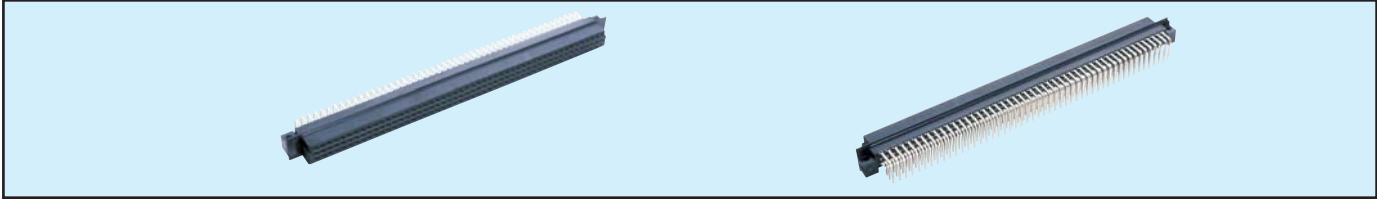

Contact Design and Termination Length	Number of Contacts	Loading Description	Part Number Performance classes according to DIN 41612	
			II	I
0.6 x 0.6 mm Post Profile 2.8 mm (Y) Right Angled	150	a + b + c fully loaded	20 8577 150 001 025	20 8577 150 001 049
		a + c fully loaded	20 8577 150 001 026	20 8577 150 001 050

NB: Alternative Prefix Variations Available: 26, please refer to Page 10.  
Additional Plating & Loading Variations: Please contact your local AVX sales office or distributor.

## LOADING DESCRIPTION

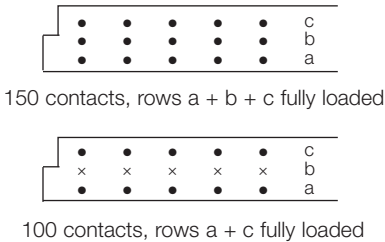

## DIMENSIONS

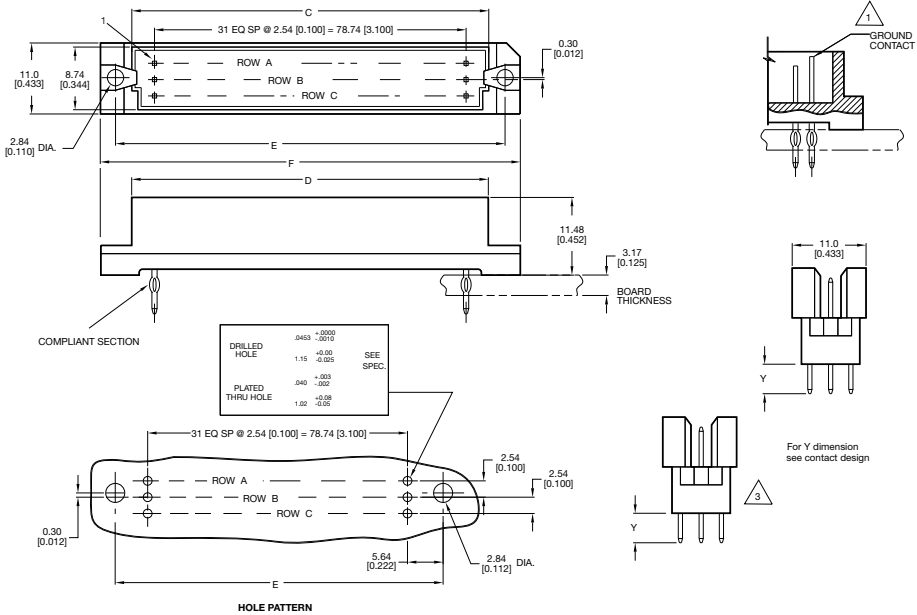

Unit: millimeters (inches)

No. Contact Positions	Contact Rows	A	B	C	D	E	F
150	3 (3 x 50)	49	125.50 (4.941)	130.90 (5.154)	133.60 (5.260)	135.70 (5.343)	140.60 (5.536)

## X-ON Electronics

Largest Supplier of Electrical and Electronic Components

*Click to view similar products for [DIN 41612 Connectors](#) category:*

*Click to view products by [Kyocera AVX](#) manufacturer:*

Other Similar products are found below :

[004.767](#) [608489050008049](#) [691327-1](#) [74670-0732](#) [74680-0340](#) [75880-0015](#) [76453-0014](#) [86093159ALF](#) [9732967801](#) [QLC260R](#)  
[120X10019X](#) [120X10089X](#) [122A10249X](#) [122A11089X](#) [122A13089X](#) [122A10089X](#) [122A10129X](#) [122A10349X](#) [122A13359X](#) [1377391-4](#)  
[DIN-048CPC-SR1-MH](#) [1393583-2](#) [1393726-7](#) [140X10129X](#) [143-1913-000](#) [143-1908-000](#) [1484472-1](#) [2110070-1](#) [2110070-2](#) [CBC20T00-](#)  
[008FDS5-0-1-002VR](#) [172699-5036](#) [2-1393557-4](#) [2-1437084-2](#) [394506](#) [419-2080-402](#) [419-2085-302](#) [V42254B2202C968](#) [419-2086-201](#) [419-](#)  
[2087-002](#) [448657-1](#) [448847-3](#) [5-1393755-9](#) [02990000004](#) [033020](#) [054302](#) [043556](#) [0760557108](#) [09062483201750](#) [0850033067](#)  
[09031646555](#)