

0.35mm Pitch
Board to Board Connector

5843 Series

シリーズ (Series)	5843
基板間高さ (Stacking Height)	0.8 / 1.0 / 1.5mm
極間隔 (Pitch)	0.35mm
極数 (No. of Positions)	10 to 48 Pos.
定格電流 (Rated Current)	DC 0.3A/Contact
定格電圧 (Rated Voltage)	DC 60V/Contact
耐電圧 (D. W. Voltage)	AC 250Vrms/min.
コンタクト材質 (Contact Material)	銅合金 (Copper alloy)
インシュレータ材質 (Insulator Material)	耐熱樹脂 (Heat-resistant plastic)
使用温度範囲 (Operating Temperature)	-40 to +85°C

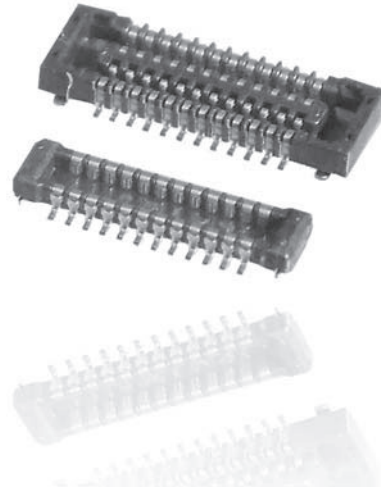

◆概要

5843 シリーズは、0.35mm の狭ピッチ基板対基板用コネクタで、嵌合（基板間）高さ 0.8mm/1.0mm/1.5mm、奥行き寸法 2.4mm の省スペース製品です。コネクタの裏面は絶縁の底壁を形成しコンタクトの露出をなくしたことで、基板配線設計の自由度を向上した製品です。

◆特長

- (1) 0.35mm ピッチ、奥行き寸法 2.4mm、嵌合（基板間）高さ 0.8mm/1.0mm/1.5mm の省スペース型コネクタで、基板実装面積の省面積化に貢献します。
- (2) 嵌合時のロック構造は、弊社独自のロック構造を採用。低背でありながらも優れたクリック感と、抜去時の保持力を強化しています。
- (3) スリム・低背でありながらコネクタ裏面に底壁を設けて金属の露出をなくし、製品の端子ランド対向間のパターン配線をも可能としました。高密度実装に最適な構造です。
- (4) 接点部は、「挟み込み接点形状」（2点接点）を採用し、振動や落下衝撃などに強い構造となっています。また、プラグコンタクトの形状は、集中荷重を上げて異物を排除（ワイピング効果）する機構を施し、高い接触信頼性を実現しています。
- (5) 5,000 個入りのエンボステープ梱包でお届けします。
- (6) 環境に優しい RoHS 指令対応品です。

◆Outline

The 5843 Series are Board to Board Connectors with a fine pitch of 0.35mm. This space-saving product features a stacking height of 0.8/1.0/1.5mm (between boards) as well as a width of 2.4mm. The bottoms of the connectors are insulated and avoid exposure of contacts, thus enabling flexible designs on printed circuit boards.

◆Features

- (1) Space-saving connectors featuring a pitch of 0.35mm, width of 2.4mm, and stacking height of 0.8/1.0/1.5mm between the boards, which contribute to downsizing of mounting areas.
- (2) An original locking structure is adopted for mating, which generates a firm “click” sound and enhances the retention force when connectors are removed despite the low profile.
- (3) As there is a bottom surface on the back of the connector and the contact part is not exposed, wiring patterns can be flexibly laid out on the substrate area which will be positioned between the terminals.
- (4) The contact structure employs a pinching structure (two-point contact design), which is highly resistant to vibration and drop shocks. Further, plug contacts incorporate an original structure with a wiping effect that eliminates foreign matter with concentrated load, thus ensuring excellent contact reliability.
- (5) Packaged in tape and reel: 5,000 pieces/reel.
- (6) RoHS compliant product.

0.35mm Pitch 5843 Series

0.35mm ピッチ 嵌合高さ 0.8/1.0/1.5mm 金具付き SMT
0.35mm Pitch, Stacking Height=0.8/1.0/1.5mm, With Metal tabs, SMT

● Plug (嵌合高さ 0.8/1.0/1.5mm 共通)

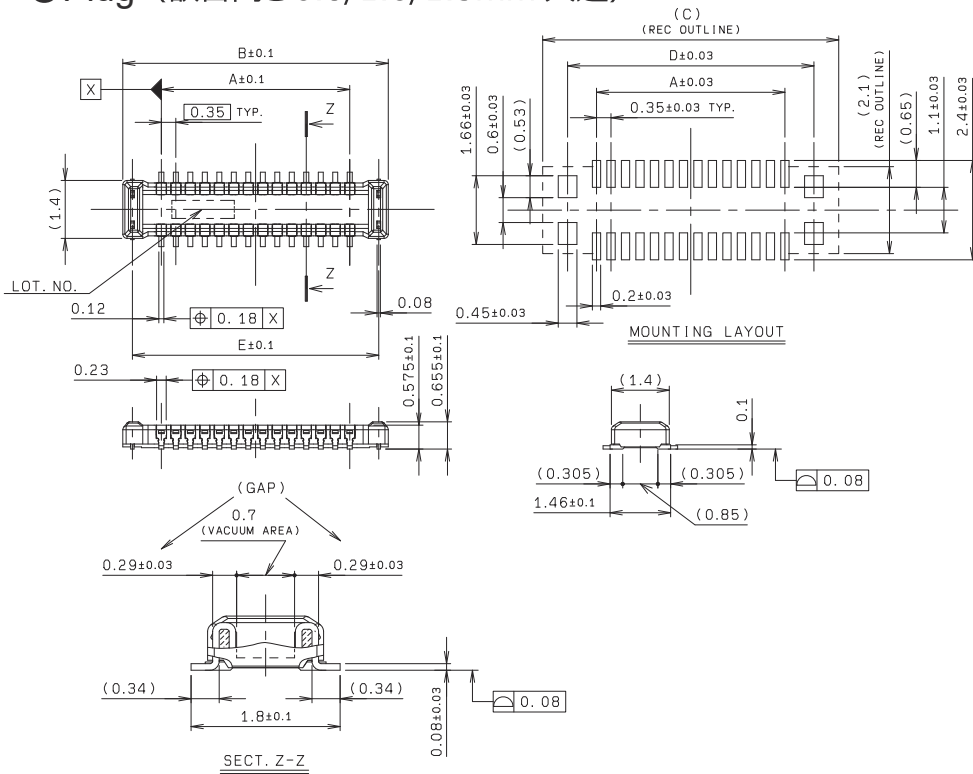

嵌合するリセプタクルコネクタは、
次ページの 24 5843 XXX 0X2 829+ です。
24 5843 XXX 0X2 829+ on the next page are
receptacle connectors to be mated.

● Packaging

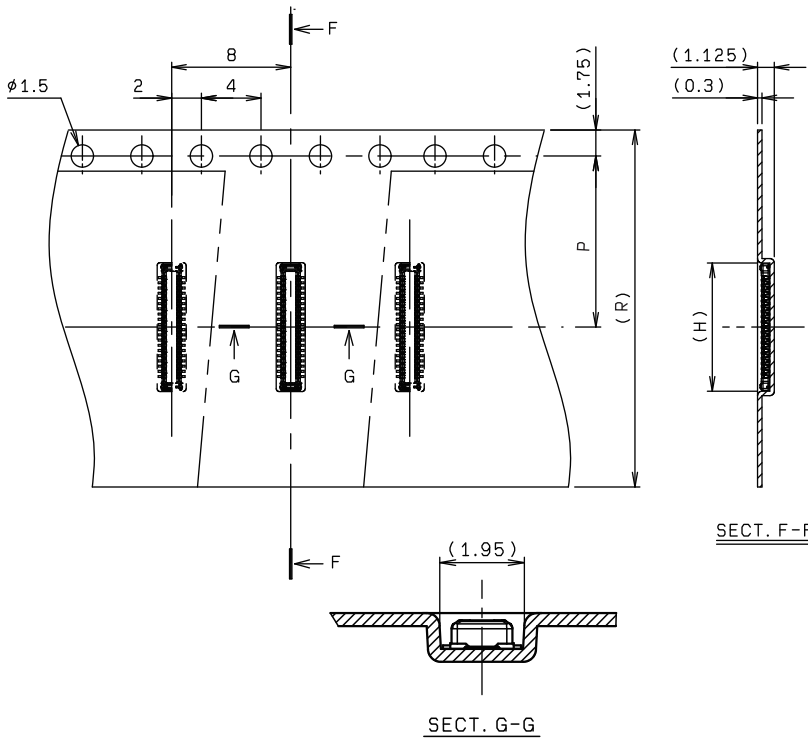

極数 NO. OF POS.	A	B	C	D	P	R	H
10	1.40	3.26	4.00	2.80	7.5	16.0	3.36
12	1.75	3.61	4.35	3.15			3.71
14	2.10	3.96	4.70	3.50			4.06
16	2.45	4.31	5.05	3.85			4.41
18	2.80	4.66	5.40	4.20			4.76
20	3.15	5.01	5.75	4.55			5.11
22	3.50	5.36	6.10	4.90			5.46
24	3.85	5.71	6.45	5.25			5.81
26	4.20	6.06	6.80	5.60			6.16
28	4.55	6.41	7.15	5.95			6.51
30	4.90	6.76	7.50	6.30	11.5	24.0	6.86
32	5.25	7.11	7.85	6.65			7.21
34	5.60	7.46	8.20	7.00			7.56
36	5.95	7.81	8.55	7.35			7.91
38	6.30	8.16	8.90	7.70			8.26
40	6.65	8.51	9.25	8.05			8.61
42	7.00	8.86	9.60	8.40			8.96
44	7.35	9.21	9.95	8.75			9.31
46	7.70	9.56	10.30	9.10			9.66
48	8.05	9.91	10.65	9.45			10.01

※極数により梱包仕様が異なる可能性があります。
For some numbers of positions, the packaging specification would vary.

注文コード/Ordering Code

Plug
Part No. 14 5843 XXX 022 829+
極数 No. of Pos.

RoHS 対応品
RoHS Compliant Product

梱包数量：5,000 個/リール
PACKING QUANTITY: 5,000/Reel

本カタログには推奨めっきを掲載しております。めっき種類・仕様、ならびに生産対応可能極数については営業部にご確認願います。
Recommended plating types are mentioned in this catalogue. For other plating types and their specifications, and available numbers of positions, please feel free to contact our sales department.

0.35mm Pitch 5843 Series

0.35mm ピッチ 嵌合高さ 0.8/1.0/1.5mm 金具付き SMT
0.35mm Pitch, Stacking Height=0.8/1.0/1.5mm, With Metal tabs, SMT

● Receptacle

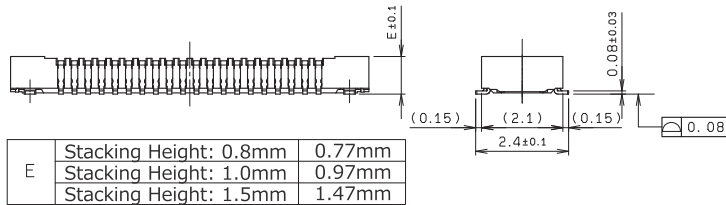
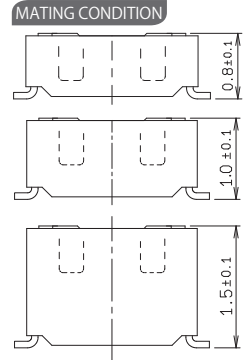
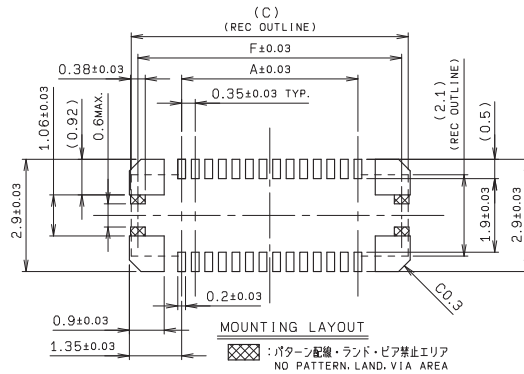
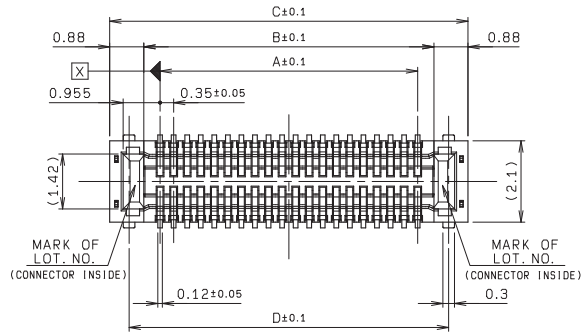

E	Stacking Height: 0.8mm	0.77mm
	Stacking Height: 1.0mm	0.97mm
	Stacking Height: 1.5mm	1.47mm

嵌合するプラグコネクタは、
前ページの 14 5843 XXX 022 829+ です。
14 5843 XXX 0X2 829+ on the previous page are
plug connectors to be mated.

● Packaging

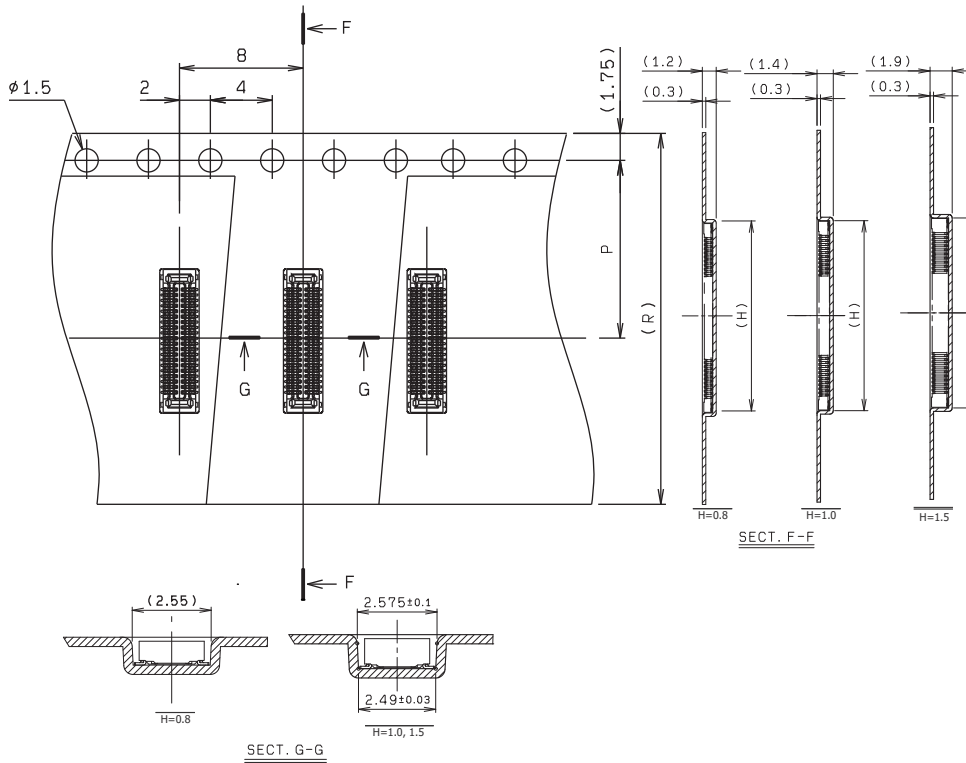

極数 NO. OF POS.	A	B	C	D	F	P	R	H
10	1.40	2.24	4.00	3.00	3.66	7.5	16.0	4.10
12	1.75	2.59	4.35	3.35	4.01			4.45
14	2.10	2.94	4.70	3.70	4.36			4.80
16	2.45	3.29	5.05	4.05	4.71			5.15
18	2.80	3.64	5.40	4.40	5.06			5.50
20	3.15	3.99	5.75	4.75	5.41			5.85
22	3.50	4.34	6.10	5.10	5.76			6.20
24	3.85	4.69	6.45	5.45	6.11			6.55
26	4.20	5.04	6.80	5.80	6.46			6.90
28	4.55	5.39	7.15	6.15	6.81			7.25
30	4.90	5.74	7.50	6.50	7.16	7.60		
32	5.25	6.09	7.85	6.85	7.51	7.95		
34	5.60	6.44	8.20	7.20	7.86	8.30		
36	5.95	6.79	8.55	7.55	8.21	8.65		
38	6.30	7.14	8.90	7.90	8.56	9.00		
40	6.65	7.49	9.25	8.25	8.91	9.35		
42	7.00	7.84	9.60	8.60	9.26	9.70		
44	7.35	8.19	9.95	8.95	9.61	10.05		
46	7.70	8.54	10.30	9.30	9.96	10.40		
48	8.05	8.89	10.65	9.65	10.31	10.75		

※極数により梱包仕様が異なる可能性があります。
For some numbers of positions, the packaging specification would vary.

注文コード/Ordering Code

Part No. 24 5843 XXX 0X2 829+

RoHS 対応品
RoHS Compliant Product

0: Receptacle, Stack. H=0.8mm
3: Receptacle, Stack. H=1.0mm
4: Receptacle, Stack. H=1.5mm

梱包数量: 5,000 個/リール
PACKING QUANTITY: 5,000/Reel

本カタログには推奨めっきを掲載しております。めっき種類・仕様、ならびに生産対応可能極数については営業部にご確認願います。
Recommended plating types are mentioned in this catalogue. For other plating types and their specifications, and available numbers of positions, please feel free to contact our sales department.

X-ON Electronics

Largest Supplier of Electrical and Electronic Components

Click to view similar products for [Board to Board & Mezzanine Connectors](#) category:

Click to view products by [Kyocera AVX](#) manufacturer:

Other Similar products are found below :

[589158040000018](#) [MDF7C-18P-2.54DSA\(55\)](#) [FCN-230C068-11](#) [FCN-268F012-G/BD](#) [FCN-268F036-G/BD](#) [FCN-268M012-G/0D](#) [FCN-268M024-G/1D](#) [FCN-723J004/1](#) [MIS-048-01-F-D-DP-K](#) [832-10-034-10-001000](#) [FX4C-80S-1.27DSA](#) [FCN-214Q030-G/0](#) [FCN-234P048-G/0](#) [FCN-235D050-G/C](#) [210-93-314-41-105000](#) [2-22603-0](#) [MDF7-40DP-2.54DSA\(55\)](#) [AXG720047](#) [5031084030](#) [MIT-114-03-F-D-K](#) [55323-1519](#) [DF33-2P-3.3DSA\(24\)](#) [YFT-20-05-H-03-SB-K](#) [503308-3040](#) [026-6203-PDB](#) [027-6203-PDB](#) [069159702701000](#) [10123981-102LF](#) [101A10019X](#) [55650-0588-C](#) [68684-306](#) [75140-7012](#) [589159005003045](#) [194261-1](#) [FCN-268F024-G0D](#) [10124054-515LF](#) [68685-603](#) [8-1616154-3](#) [MIS-019-01-F-D](#) [589159005002045](#) [541371078](#) [IL-WX-10PB-HF-B-E1000E](#) [FCN-268M024-G/3D](#) [20021832-06016C1LF](#) [KX15-20KLDL-E1000E](#) [MDF7-16DP-2.54DSA\(55\)](#) [AXE810124](#) [FCN-214J100-G/0](#) [FCN-230C068-E/S](#) [AXE812124](#)