

1.0 mm Pitch

Board to Board Connector

5078 Series

シリーズ (Series)	5078
基板間高さ (Stacking Height)	-
極間隔 (Pitch)	1.0mm
極数 (No. of Positions)	30 to 60 Pos.
定格電流 (Rated Current)	AC/DC 0.5A
定格電圧 (Rated Voltage)	AC/DC 100V/Contact
耐電圧 (D. W. Voltage)	AC 500Vrms/min.
コンタクト材質 (Contact Material)	銅合金 (Copper alloy)
インシュレータ材質 (Insulator Material)	耐熱樹脂 (Heat-resistant plastic)
使用温度範囲 (Operating Temperature)	-40 to +85°C

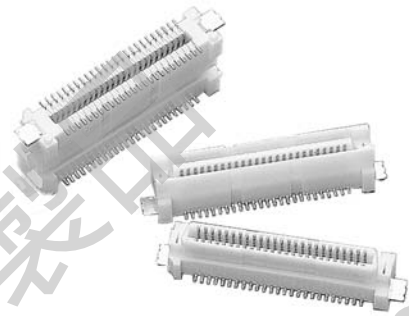

◆概要

5078シリーズは、1.0mmピッチ、SMTタイプ2ピースの基板対基板コネクタです。コンタクトは独自の構造で、高信頼性を実現しました。保持金具付きで、機械的ストレスからも保護します。

◆特長

- (1) 基板を垂直に接続するタイプと、基板を水平に接続するタイプの2種を取り揃え、設計の自由度を高めています。
- (2) エンボステープ梱包でお届けします。
- (3) 環境に優しい RoHS 指令対応品です。

◆Outline

The 5078 Series are 1.0mm pitch, SMT, two-piece Board to Board Connectors. In addition, these connectors are protected against mechanical stress by metal tabs.

◆Features

- (1) In order to enhance less limitation in designing at customers' site, there are two types to connect printed circuit boards; vertically and horizontally.
- (2) Packaged in tape and reel.
- (3) RoHS compliant product

●5078 Series

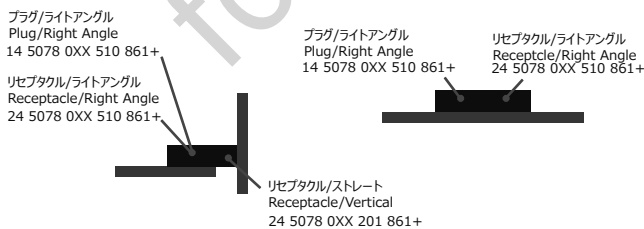

本カタログには推奨めっきを掲載しております。めっき種類・仕様、ならびに生産対応可能極数については営業部にご確認願います。
Recommended plating types are mentioned in this catalogue. For other plating types and their specifications, and available numbers of positions, please feel free to contact our sales department.

1.0mm Pitch 5078 Series



1.0mm ピッチ プラグ ライトアングルタイプ SMT
1.0mm Pitch, Plug, Right angle type, SMT

094B-1701-0
093A-1701-0

● Plug

極数 NO. OF POS.	A	B	C	D	E	F	G
30P	14.0	14.5	22.0	16.0	18.7	18.0	20.0
40P	19.0	19.5	27.0	21.0	23.7	23.0	25.0
50P	24.0	24.5	32.0	26.0	28.7	28.0	30.0
60P	29.0	29.5	37.0	31.0	33.7	33.0	35.0

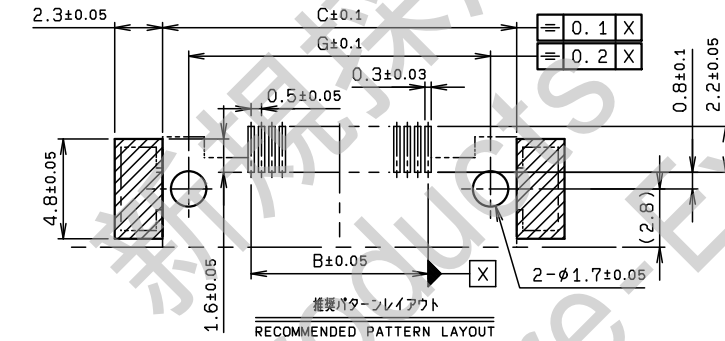
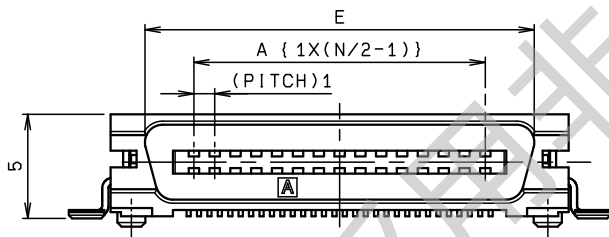
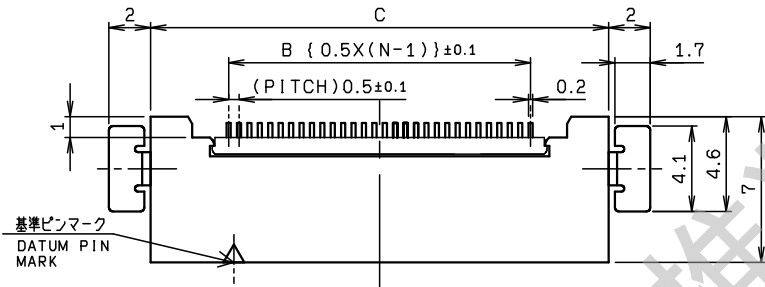
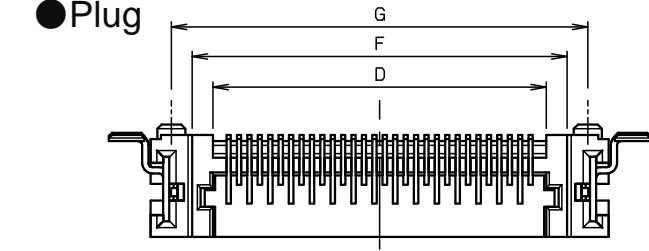

推奨パターンレイアウト
RECOMMENDED PATTERN LAYOUT

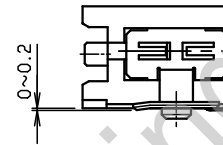
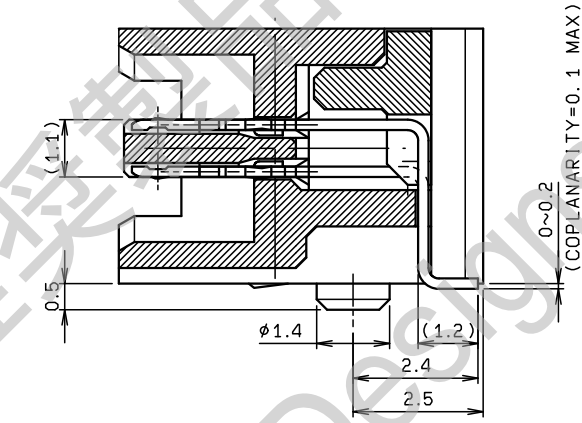

● Packaging

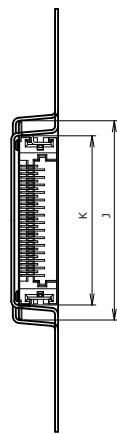

SECT. C-C

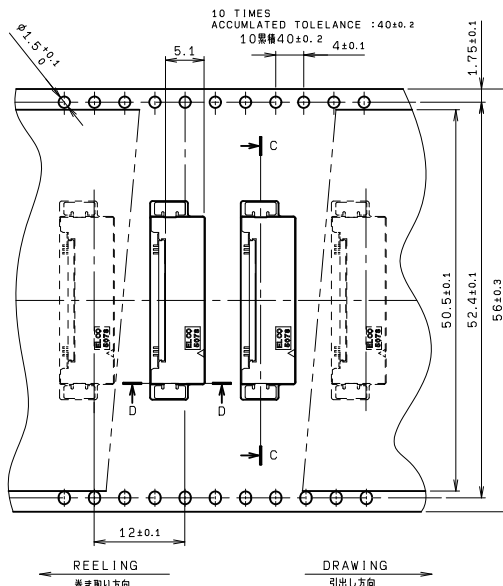

極数 NO. OF POS.	J	K
30	26.4	22.4
40	31.4	27.4
50	36.4	32.4
60	41.4	37.4

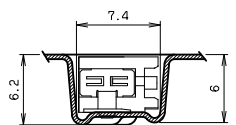

SECT. D-D

注文コード/Ordering Code

Plug
Part No. 14 5078 0XX 510 861+

極数 No. of Pos.

RoHS 対応品
RoHS Compliant Product

梱包数量 : 1,000 個/リール
PACKING QUANTITY: 1,000/Reel

本カタログには推奨めっきを掲載しております。めっき種類・仕様、ならびに生産対応可能極数については営業部にご確認願います。
Recommended plating types are mentioned in this catalogue. For other plating types and their specifications, and available numbers of positions, please feel free to contact our sales department.

1.0mm Pitch 5078 Series



1.0mm ピッチ リセプタクル ライトアングルタイプ SMT
1.0mm Pitch, Receptacle, Right angle type, SMT

094B-1701-0
093A-1701-0

● Receptacle

【基板垂直接続
(Right Angle)】

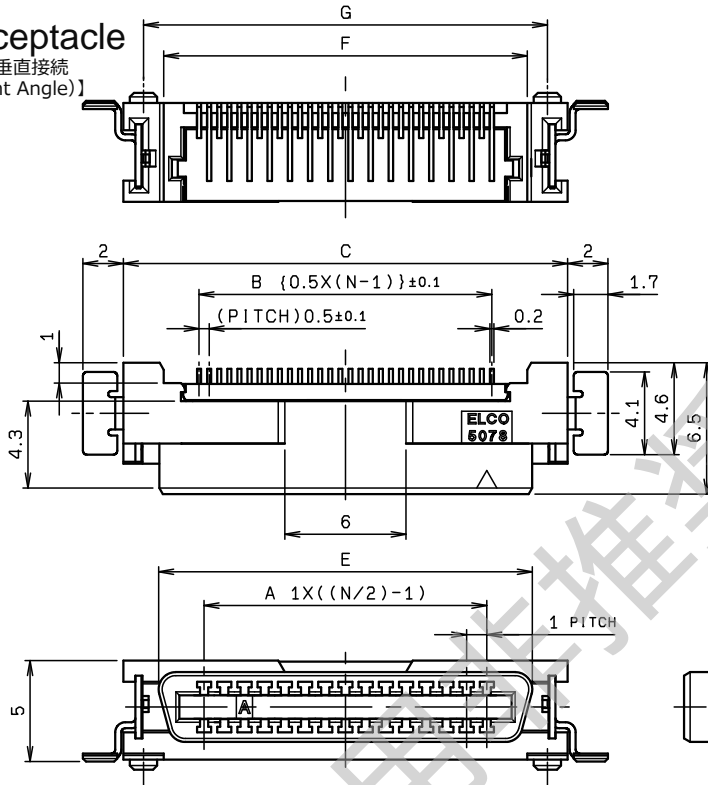

極数 NO. OF POS.	A	B	C	E	F	G
30	14.0	14.5	22.0	18.5	18.0	20.0
40	19.0	19.5	27.0	23.5	23.0	25.0
50	24.0	24.5	32.0	28.5	28.0	30.0
60	29.0	29.5	37.0	33.5	33.0	35.0

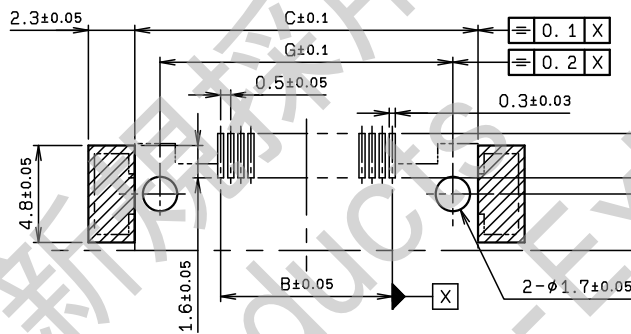
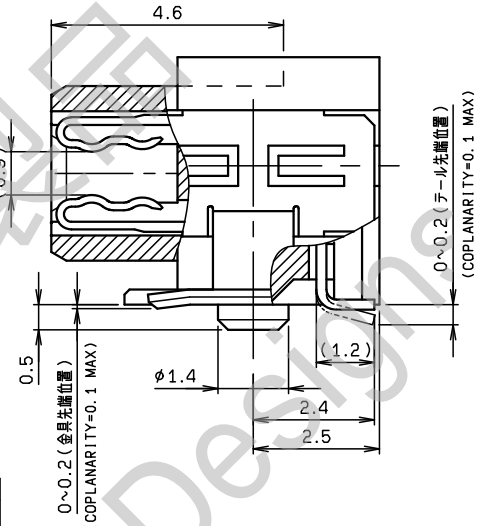

推奨パターンレイアウト
RECOMMENDED PATTERN LAYOUT

● Packaging

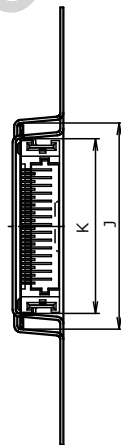

SECT. C-C

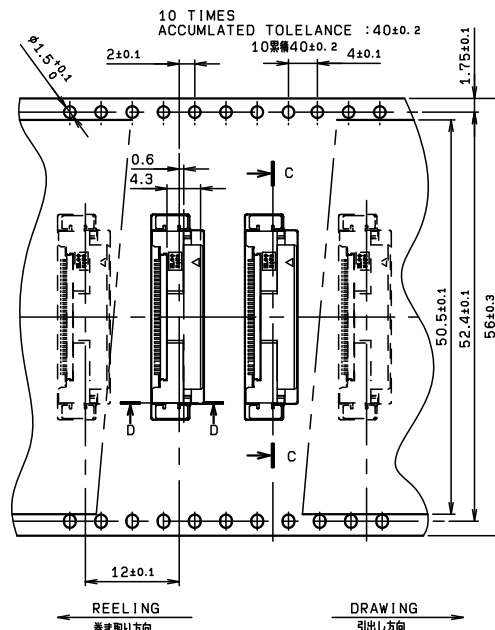

極数 NO. OF POS.	J	K
30	26.4	25.4
40	31.4	30.4
50	36.4	35.4
60	41.4	40.4

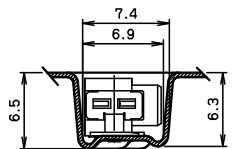

SECT. D-D

注文コード/Ordering Code
Receptacle

Part No. 24 5078 0XX 510 861+

極数 No. of Pos.

RoHS 対応品
RoHS Compliant Product

梱包数量：1,000 個/リール
PACKING QUANTITY: 1,000/Reel

本カタログには推奨めっきを掲載しております。めっき種類・仕様、ならびに生産対応可能極数については営業部にご確認願います。
Recommended plating types are mentioned in this catalogue. For other plating types and their specifications, and available numbers of positions, please feel free to contact our sales department.

1.0mm Pitch 5078 Series

1.0mm ピッチ リセプタクル ストレートタイプ SMT
1.0mm Pitch, Receptacle, Vertical type, SMT

094B-1701-0
093A-1701-0

● Receptacle

【基板垂直接続 (Vertical)】

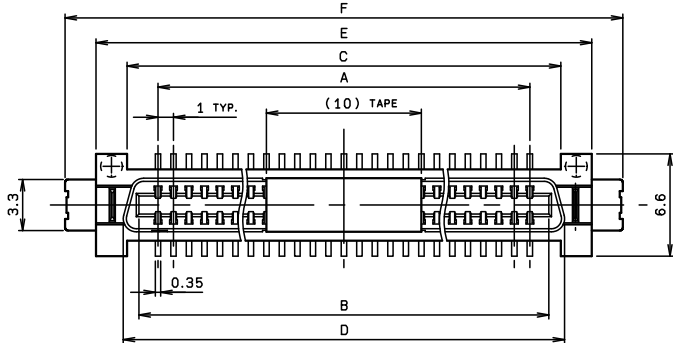

種 類 NO. OF POS.	A	B	C	D	E	F	G
30	14.0	16.25	18.0	18.5	22.0	26.0	20.0
40	19.0	21.25	23.0	23.5	27.0	31.0	25.0
50	24.0	26.25	28.0	28.5	32.0	36.0	30.0
60	29.0	31.25	33.0	33.5	37.0	41.0	35.0

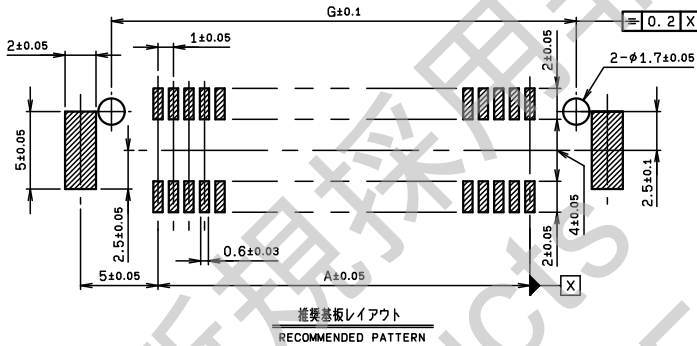
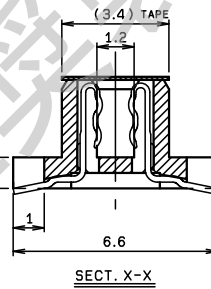
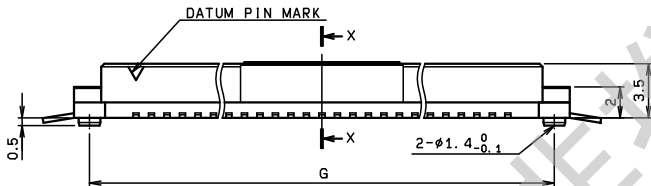
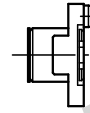

● Packaging

種 類 NO. OF POS.	J	K	L
30	26.2	52.4	56.0
40	26.2	52.4	56.0
50	26.2	52.4	56.0
60	26.2	52.4	56.0

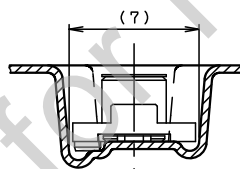

SECT. F-F

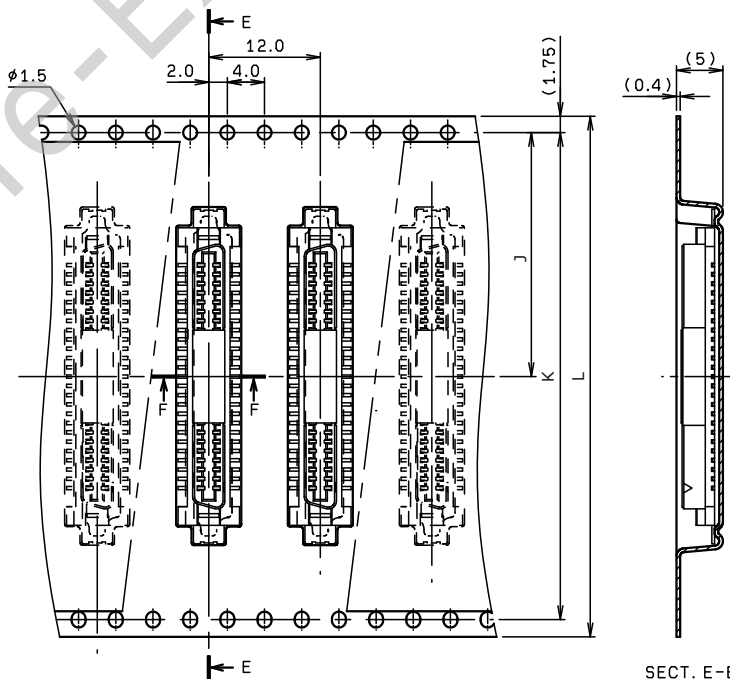

SECT. E-E

注文コード/Ordering Code
Receptacle

Part No. **24 5078 0XX 201 861+**

└ 極数 No. of Pos.

RoHS 対応品
RoHS Compliant Product

梱包数量 : 1,000 個/リール
PACKING QUANTITY: 1,000/Reel

本カタログには推奨めっきを掲載しております。めっき種類・仕様、ならびに生産対応可能極数については営業部にご確認願います。
Recommended plating types are mentioned in this catalogue. For other plating types and their specifications, and available numbers of positions, please feel free to contact our sales department.

X-ON Electronics

Largest Supplier of Electrical and Electronic Components

Click to view similar products for [Board to Board & Mezzanine Connectors](#) category:

Click to view products by [Kyocera AVX](#) manufacturer:

Other Similar products are found below :

[589158040000018](#) [MDF7C-18P-2.54DSA\(55\)](#) [FCN-230C068-11](#) [FCN-268F012-G/BD](#) [FCN-268F036-G/BD](#) [FCN-268M012-G/0D](#) [FCN-268M024-G/1D](#) [FCN-723J004/1](#) [MIS-048-01-F-D-DP-K](#) [832-10-034-10-001000](#) [FX4C-80S-1.27DSA](#) [FCN-214Q030-G/0](#) [FCN-234P048-G/0](#) [FCN-235D050-G/C](#) [210-93-314-41-105000](#) [2-22603-0](#) [MDF7-40DP-2.54DSA\(55\)](#) [AXG720047](#) [5031084030](#) [MIT-114-03-F-D-K](#) [55323-1519](#) [DF33-2P-3.3DSA\(24\)](#) [YFT-20-05-H-03-SB-K](#) [503308-3040](#) [026-6203-PDB](#) [027-6203-PDB](#) [069159702701000](#) [10123981-102LF](#) [101A10019X](#) [55650-0588-C](#) [68684-306](#) [75140-7012](#) [589159005003045](#) [063209](#) [194261-1](#) [FCN-268F024-G0D](#) [10124054-515LF](#) [68685-603](#) [8-1616154-3](#) [MIS-019-01-F-D](#) [589159005002045](#) [541371078](#) [IL-WX-10PB-HF-B-E1000E](#) [FCN-268M024-G/3D](#) [20021832-06016C1LF](#) [KX15-20KLDL-E1000E](#) [MDF7-16DP-2.54DSA\(55\)](#) [AXE810124](#) [FCN-214J100-G/0](#) [FCN-230C068-E/S](#)