

Single IDC Contact 18-24 AWG: WTB

9176-500

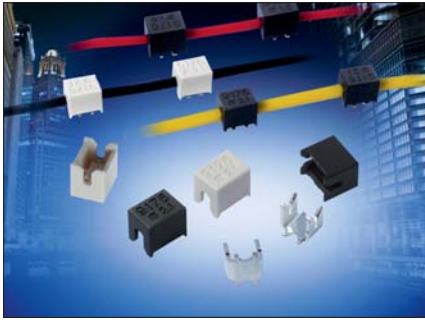

The 917X series of surface mount Insulation Displacement Connectors (IDC) were developed to meet the harsh automotive and industrial market applications for connecting individual wires directly to a PCB ranging from 14 AWG to 28 AWG. This industry proven contact system has been tested to automotive levels of shock, vibration, and temperature cycling to prove their reliability and robustness. This new single contact was developed as a standalone component to enhance the application uses with the IDC technology. The simplicity of inserting a wire into an SMT contact with a small tool or optional retention / termination cap allows a wide range of devices to be connected to the PCB without soldering. In SSL applications specifically, these contacts are used to bring power and signal onto the PCB or are used to daisy chain multiple boards together in a long string. While the IDC contact provides a gas-tight connection to conductor of the wire, the optional cap provides a positive strain relief even in the harshest conditions. In case of repair, the wires can be removed and replace up to three times.

The single 9176 series contact and cap accepts 18 AWG to 24 AWG wires with an insulation diameter ranging from 1.1mm to 2.1mm. These dual beam contacts support a 10 amp current rating with a large SMT solder base to provide maximum stability on the PCB. The optional locking strain relief cap acts as the termination tool for severe vibration applications.

APPLICATIONS

- Connecting discrete wire components directly to the PCB
- Bringing power and signals onto a PCB
- Daisy chaining PCB's together to create a continuous string of boards
- Application notes: refer to 201-01-124

FEATURES AND BENEFITS

- IDC contact is supplied in T&R pockets for standard SMT placement
- IDC contact provides a gas-tight connection to the PCB for long term reliability
- Optional termination cap provides additional strain relief for severe environments
- Tested to automotive levels on shock, vibration and temperature cycling for reliability
- Reduced total applied cost versus solder or crimp processes
- Individual contacts can be located anywhere on the PCB based on specific application

ELECTRICAL

- Current Rating: 10 Amps/Contact
- Voltage Rating: Dependant on component proximity

ENVIRONMENTAL

- Operating Temperature: -40°C to +125°C

MECHANICAL

- Insulator Material: Nylon 46: UL94V0
- Contact Material: Phosphor Bronze
- Plating: Tin over Nickel
- Durability: 3 Cycles

HOW TO ORDER – CONTACT OPTIONS

70	9176	001	5XX	006																
Prefix	Series	Number of Ways	Wire Gauge Size	Plating Option																
70 = Contact				006 = Pure Tin all over																
		<table border="1"> <thead> <tr> <th>Code</th> <th>No of Ways</th> <th>Details</th> </tr> </thead> <tbody> <tr> <td>001</td> <td>1</td> <td>Page 3</td> </tr> </tbody> </table>	Code	No of Ways	Details	001	1	Page 3	<table border="1"> <thead> <tr> <th>Code</th> <th>Accepted Wire Gauge</th> </tr> </thead> <tbody> <tr> <td>501</td> <td>18 Gauge Stranded</td> </tr> <tr> <td>511</td> <td>20 Gauge Solid or Stranded</td> </tr> <tr> <td>522</td> <td>22 Gauge Solid or Stranded</td> </tr> <tr> <td>532</td> <td>24 Gauge Solid or Stranded</td> </tr> </tbody> </table>	Code	Accepted Wire Gauge	501	18 Gauge Stranded	511	20 Gauge Solid or Stranded	522	22 Gauge Solid or Stranded	532	24 Gauge Solid or Stranded	
Code	No of Ways	Details																		
001	1	Page 3																		
Code	Accepted Wire Gauge																			
501	18 Gauge Stranded																			
511	20 Gauge Solid or Stranded																			
522	22 Gauge Solid or Stranded																			
532	24 Gauge Solid or Stranded																			

HOW TO ORDER – CAP OPTIONS

60	9176	001	5XX	X00																						
Prefix	Series	Number of Ways	Wire Gauge Size	Insulator Color																						
60 = Cap																										
		<table border="1"> <thead> <tr> <th>Code</th> <th>No of Ways</th> <th>Details</th> </tr> </thead> <tbody> <tr> <td>001</td> <td>1</td> <td>Page 5</td> </tr> </tbody> </table>	Code	No of Ways		Details	001	1	Page 5	<table border="1"> <thead> <tr> <th>Code</th> <th>Wire Insulation (AWG)</th> </tr> </thead> <tbody> <tr> <td>516</td> <td>1.1-1.6 (22-24)</td> </tr> <tr> <td>521</td> <td>1.6-2.1 (18-20)</td> </tr> </tbody> </table>	Code	Wire Insulation (AWG)	516	1.1-1.6 (22-24)	521	1.6-2.1 (18-20)	<table border="1"> <thead> <tr> <th>Code</th> <th>Color</th> <th>Application</th> </tr> </thead> <tbody> <tr> <td>000</td> <td>Black</td> <td>Industrial</td> </tr> <tr> <td>100</td> <td>White</td> <td>Lighting</td> </tr> </tbody> </table>	Code	Color	Application	000	Black	Industrial	100	White	Lighting
Code	No of Ways	Details																								
001	1	Page 5																								
Code	Wire Insulation (AWG)																									
516	1.1-1.6 (22-24)																									
521	1.6-2.1 (18-20)																									
Code	Color	Application																								
000	Black	Industrial																								
100	White	Lighting																								

CONNECTOR/TOOLING PART NUMBER MATRIX

SERIES 9176-500 IDC				HAND INSERTION TOOLING*		ACCESSORY CAPS		
AWG	Wire Insulation	Positions	Part Number	Plastic (medium volume)	Metal (high volume)	Cap Application Tool	White	Black
18	Ø 1.6 - 2.1	1p	709176001501006	069176702001000	069176701901000	069176701801000	609176001521100	609176001521000
20	Ø 1.6 - 2.1	1p	709176001511006	069176702001000	069176701901000	069176701801000	609176001521100	609176001521000
22	Ø 1.1 - 1.6	1p	709176001522006	069176702002000	069176701902000	069176701801000	609176001516100	609176001516000
24	Ø 1.1 - 1.6	1p	709176001532006	069176702002000	069176701902000	069176701801000	609176001516100	609176001516000

* Hand Insertion Tooling and Cap Application - Universal Hand Tool 067000773001000; Consult Application Notes 201-01-124

Certification: UL File #E90723



CONTACT DETAILS

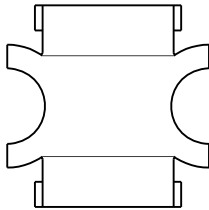
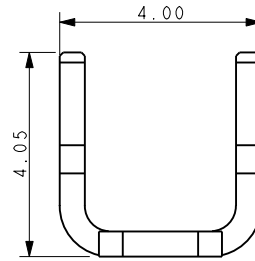
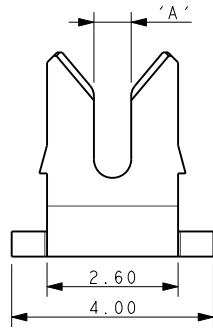

AREA AVAILABLE FOR PICK & PLACE 2.00mm SQUARE

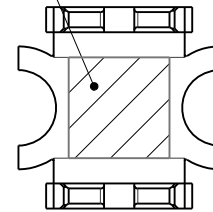

Code	Accepted Wire Gauge	A
501	18 AWG Stranded	0.72
511	20 AWG Solid and Stranded	0.60
522	22 AWG Solid and Stranded	0.47
532	24 AWG Solid and Stranded	0.37

NOTES:

- CONNECTOR FOR IDC WIRE TO BOARD CONNECTION.
- CONTACT MATERIAL: PHOSPHOR BRONZE.
- CONTACT PLATING: PURE TIN.
- CONNECTOR DESIGNED TO ACCEPT BETWEEN 18 AND 24 GAUGE STRANDED WIRE. SEE TABLE.
- ALL DIMENSIONS FOR REFERENCE UNLESS OTHERWISE STATED.
- FOR FULL PRODUCT SPECIFICATION REFER TO ELCO SPEC 201-01-106 AND APPLICATION NOTES 201-01-124.
- SMT PCB LAYOUT, REFER TO PAGE 3.
- PACKING IN TAPE AND REEL, QUANTITY 1000 PER REEL.
- WHEN REQUIRED, MATCHING CAP DETAILS ON DRAWING 60-9176-001-5XX-X00S.
- ASSEMBLY TOOLING ON PAGE 5 (WITH CAP AND WITHOUT CAP).

PACKING DETAILS

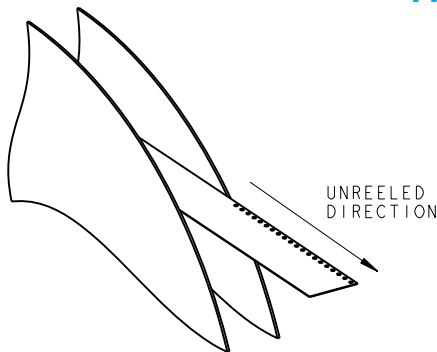

REEL QTY	1000
LEADER	480MM
TRAILER	120MM

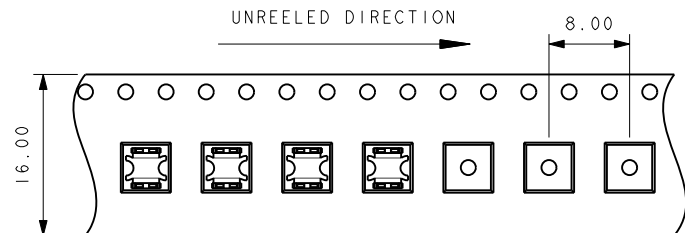

18-24 AWG IDC WIRE TO BOARD CONNECTOR SINGLE CONTACT

SMT PCB LAYOUT

PURE TIN PADS

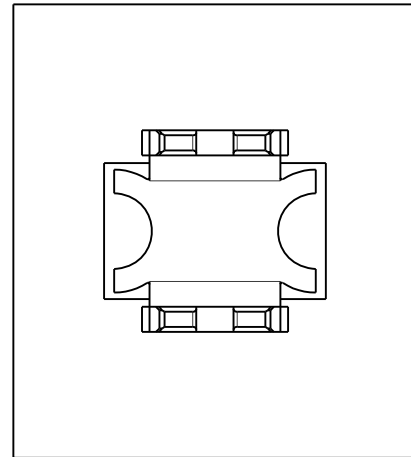
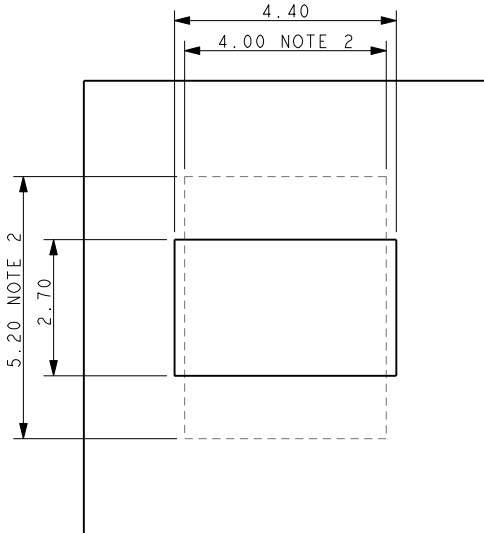

ORIENTATION OF CONTACT ON PAD

ASSEMBLED/INSTALLED PRODUCTS

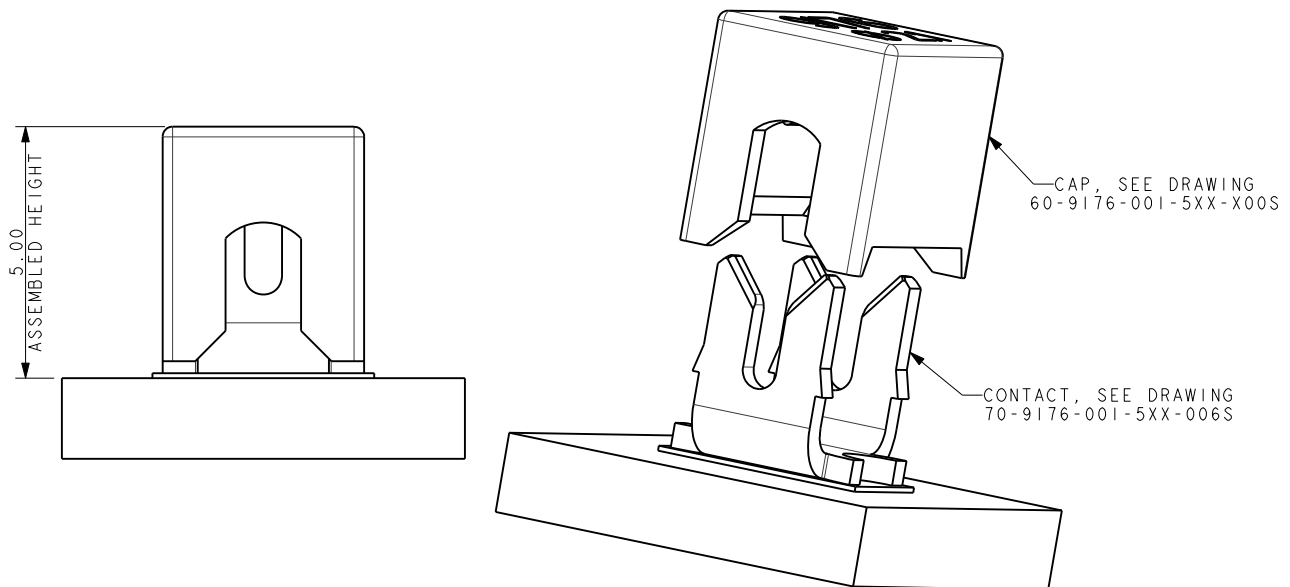

NOTES:

1. CONNECTOR CAN BE USED WITH CONTACT ONLY OR WITH OPTIONAL CAP.
2. OUTLINE OF CAP WHEN USED.
3. FOR FULL PRODUCT SPECIFICATION REFER TO ELCO SPEC 201-01-106 AND 201-01-124.
4. DIMENSIONS SHOWN ARE REFERENCED DIMENSIONS.
5. ASSEMBLY TOOLING ON PAGE 43 (WITH CAP AND WITHOUT CAP).

Single IDC Contact 18-24 AWG: WTB

9176-500

ASSEMBLY TOOLING – CAP USED

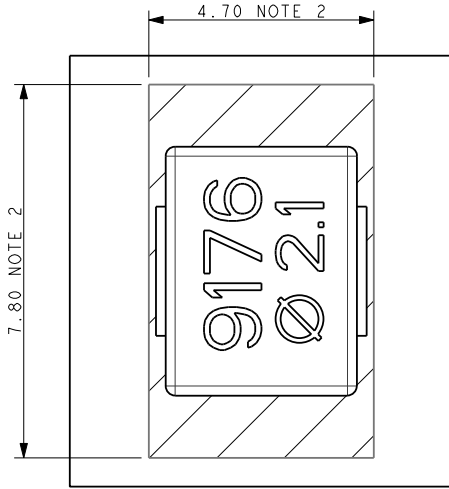

CAP APPLICATION TOOL

06-9176-7018-01-000

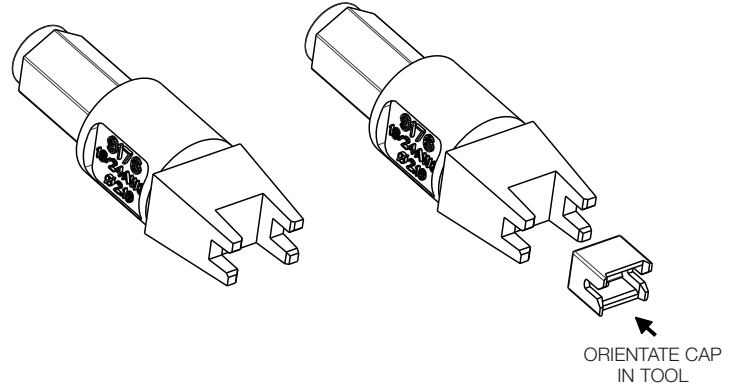

UNIVERSAL HANDLE

06 7000 7730 01 000

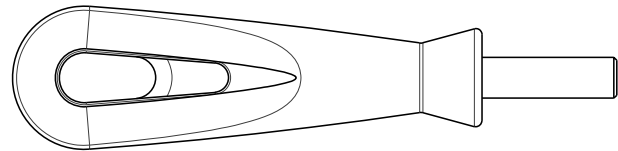

NOTES:

1. ASSEMBLY TOOLING FOR CAP.
2. AREA OF PCB TO BE KEPT CLEAR OF COMPONENTS, TACKS PERMISSIBLE.
3. WIRE AND CAP INSERTED IN ONE OPERATION.
4. REFER TO APPLICATION NOTE 201-01-124 FOR FURTHER INFORMATION.
5. REFER BELOW WHEN CONTACT USED WITHOUT CAP.

ASSEMBLY TOOLING – CAP NOT USED WIRE ONTO CONTACT

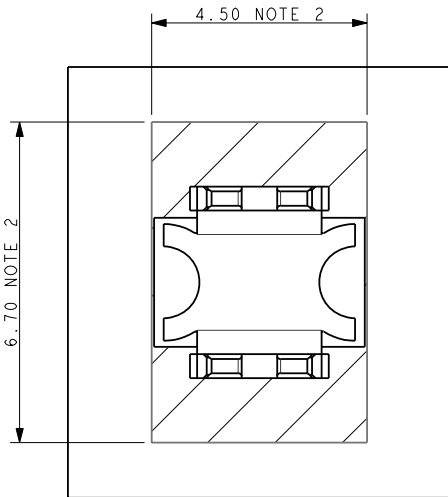

2.1 WIRE (18-20 AWG)

06-9176-7019-01-000
06-9176-7020-01-000

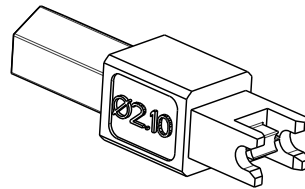

1.6 WIRE (22-24 AWG)

06-9176-7019-02-000
06-9176-7020-02-000

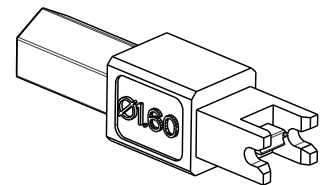

UNIVERSAL HANDLE

06 7000 7730 01 000

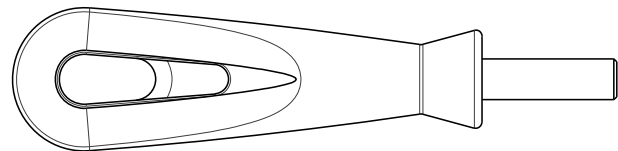

NOTES:

1. ASSEMBLY TOOLING FOR CONTACT ONLY, NO CAP USED.
2. MINIMUM AREA OF PCB TO BE KEPT CLEAR OF COMPONENTS, TRACK PERMISSIBLE.
3. REFER TO TABLE FOR CORRECT TOOL/WIRE COMBINATION.
4. REFER TO APPLICATION NOTE 201-01-124 FOR FURTHER INFORMATION.

Wire Gauge	Wire Insulation ϕ	Metal Tool High Volume	Plastic Tool Small to Medium Volume	Handle
22-24 AWG	1.10 to 1.60	06-9176-7019-02-000	06-9176-7020-02-000	06-7000-7730-01-000
18-20 AWG	1.60 to 2.10	06-9176-7019-01-000	06-9176-7020-01-000	06-7000-7730-01-000

CAP DETAILS

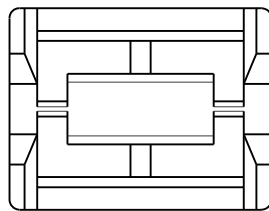
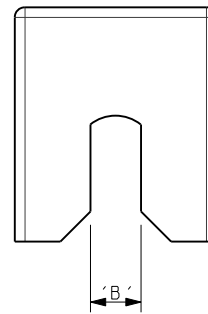
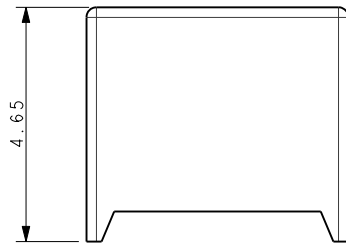
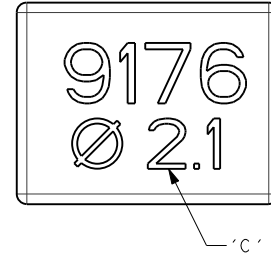
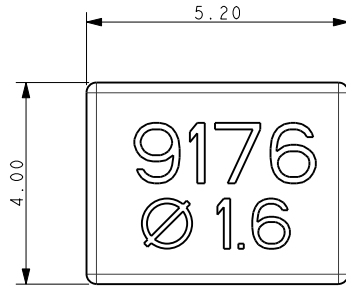

Code	Insulator Diameter (AWG)	B	Text C
516	1.1 to 1.6 (22-24)	1.00	Ø 1.6
521	1.6 to 2.1 (18-20)	1.50	Ø 2.1

NOTES:

1. CAP FOR IDC WIRE TO BOARD CONNECTION.
2. CAP MATERIAL: GLASS FILLED NYLON 46, COLOR SEE PAGE 1.
3. CAPS DESIGNED TO ACCOMMODATE WIRE INSULATION DIAMETERS 1.1MM TO 2.1MM.
4. ALL DIMENSIONS FOR REFERENCE UNLESS OTHERWISE STATED.
5. FOR FULL PRODUCT SPECIFICATION REFER TO ELCO SPEC 201-01-106, APPLICATION NOTES 201-01-124.
6. PACKING IN BAGS, QUANTITY 1000 PER BAG.
7. FOR INSTALATION DETAILS REFER TO DRAWING 70-9176-001-XX-006S.

X-ON Electronics

Largest Supplier of Electrical and Electronic Components

Click to view similar products for [Headers & Wire Housings](#) category:

Click to view products by [Kyocera AVX](#) manufacturer:

Other Similar products are found below :

[892-18-020-10-001101](#) [58102-G61-06LF](#) [582553-1](#) [0009485154](#) [009176003701906](#) [0050291907](#) [LY20-4P-DT1-P1E-BR](#) [02.125.8002.8](#)
[609-3404](#) [61062-3](#) [61082-181009](#) [622-3653LF](#) [63453-116](#) [636-1030](#) [636-1427](#) [636-3427](#) [636-4007](#) [641938-9](#) [641991-4](#) [644827-2](#) [65817-](#)
[010LF](#) [65817-015LF](#) [65863-015LF](#) [66207-023LF](#) [67095-007LF](#) [67601157](#) [68645-018](#) [68648-049](#) [70.362.1628.0](#) [70-4210](#) [70-4226B](#) [70-](#)
[4853B](#) [707-5020](#) [707-5028](#) [71.350.2428.0](#) [71918-208LF](#) [71961-016LF](#) [733-134](#) [733-162](#) [754199-000](#) [760-3052](#) [787-8014-00](#) [79531-3000](#)
[FCN-360C032-B](#) [FCN-367T-T012/H](#) [FCN-723D010/2](#) [80.063.4001.1](#) [800-90-001-10-001000](#) [800-90-010-10-002000](#) [801-43-002-10-013000](#)