

High Temperature MLCCs

AT Series – 200°C & 250°C Rated

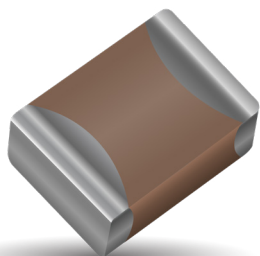

Present military specifications, as well as a majority of commercial applications, require a maximum operating temperature of 125°C. However, the emerging market for high temperature electronics demands capacitors operating reliably at temperatures beyond 125°C. AVX's high temperature chip capacitor product line, has been extended with the BME COG chip. All AT chips have verified capabilities of long term operation up to 250°C for applications in both military and commercial businesses. These capacitors demonstrate high volumetric efficiency, high insulation resistance and low ESR/ESL for the most demanding applications, such as "down-hole" oil exploration and aerospace programs.

HOW TO ORDER

AT10	3	T	104	K	A	T	2	A
AVX Style	Voltage Code	Temperature Coefficient	Capacitance Code (2 significant digits + no. of zeros)	Capacitance Tolerance	Test Level A = Standard	Termination	Packaging	Special Code A = Standard
AT03 = 0603 AT05 = 0805 AT06 = 1206 AT10 = 1210 AT12 = 1812 AT14 = 2225	16V = Y 25V = 3 50V = 5	PME COG 250°C = A COG 200°C = 2 VHT 250°C = T VHT 200°C = 4 BME COG 250°C = 5 COG 200°C = 3	101 = 100pF 102 = 1nF 103 = 10nF 104 = 100nF 105 = 1µF	J = ±5% K = ±10% M = ±20%		1 = Pd/Ag T = 100% Sn Plated (RoHS Compliant) 7 = Ni/Au Plated (For 250°C BME COG Only)	2 = 7" Reel 4 = 13" Reel 9 = Bulk	

ELECTRICAL SPECIFICATIONS

Temperature Coefficient

PME COG 0±30ppm/°C, -55C to 250°C

BME COG 0±30ppm/°C, -55C to 200°C

See TCC Plot for +250°C

VHT: T ±15%, -55°C to +150°C

See TCC Plot for +250°C

Capacitance Test (MIL-STD-202, Method 305)

25°C, 1.0 ± 0.2 Vrms (open circuit voltage) @ 1kHz

Dissipation factor 25°C

COG: 0.15% Max at 1.0 ± 0.2 Vrms (open circuit voltage) @ 1kHz

VHT: 2.5% Max at 1.0 ± 0.2 Vrms (open circuit voltage) @ 1kHz

Insulation Resistance 25°C (MIL-STD-202, Method 302)

100GΩ or 1000MΩ-µF (whichever is less)

Insulation Resistance 125°C (MIL-STD-202, Method 302)

10GΩ or 100MΩ-µF (whichever is less)

Insulation Resistance 200°C (MIL-STD-202, Method 302)

1GΩ or 10MΩ-µF (whichever is less)

Insulation Resistance 250°C (MIL-STD-202, Method 302)

100MΩ or 1MΩ-µF (whichever is less)

Direct Withstanding Voltage 25°C (Flash Test)

250% rated voltage for 5 seconds with 50mA max charging current

DIMENSIONS:

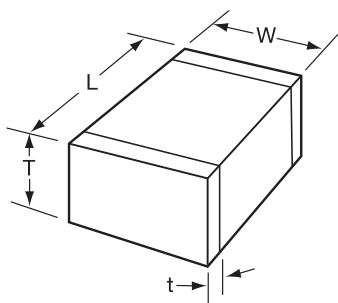

millimeters (inches)

Size	AT03 = 0603	AT05 = 0805	AT06 = 1206	AT10 = 1210	AT12 = 1812	AT14 = 2225
(L) Length	1.60 ± 0.15 (0.063 ± 0.006)	2.01 ± 0.20 (0.079 ± 0.008)	3.20 ± 0.20 (0.126 ± 0.008)	3.20 ± 0.20 (0.126 ± 0.008)	4.50 ± 0.30 (0.177 ± 0.012)	5.72 ± 0.25 (0.225 ± 0.010)
(W) Width	0.81 ± 0.15 (0.032 ± 0.006)	1.25 ± 0.20 (0.049 ± 0.008)	1.60 ± 0.20 (0.063 ± 0.008)	2.50 ± 0.20 (0.098 ± 0.008)	3.20 ± 0.20 (0.126 ± 0.008)	6.35 ± 0.25 (0.250 ± 0.010)
(T) Thickness Max.	1.02 (0.040)	1.30 (0.051)	1.52 (0.060)	1.70 (0.067)	2.54 (0.100)	2.54 (0.100)
(t) terminal	min. 0.25 (0.010) max. 0.75 (0.030)	0.25 (0.010) 0.75 (0.030)	0.25 (0.010) 0.75 (0.030)	0.25 (0.010) 0.75 (0.030)	0.25 (0.010) 1.02 (0.040)	0.25 (0.010) 1.02 (0.040)

High Temperature MLCC

AT Series – 200°C & 250°C Rated



PERFORMANCE CHARACTERISTICS

Typical Temperature Coefficient of Capacitance (VHT Dielectric)

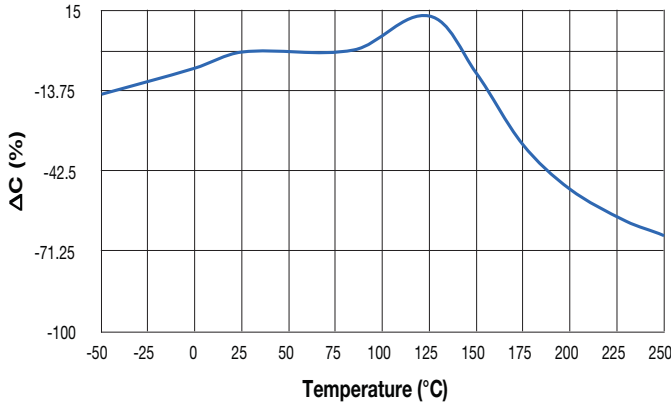

Typical Temperature Coefficient of Capacitance (COG Dielectric)

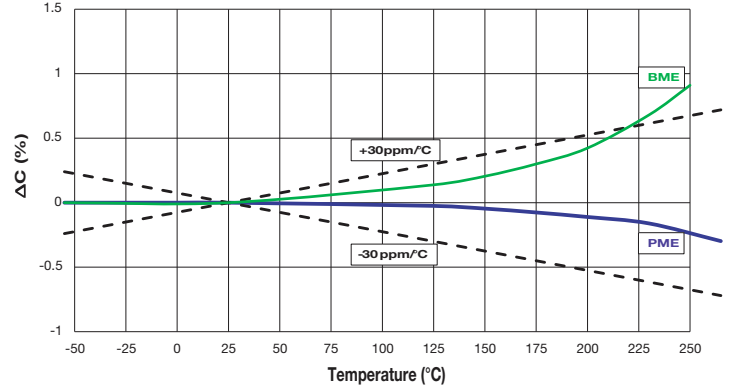

Typical Voltage Coefficient of Capacitance (VHT Dielectric)

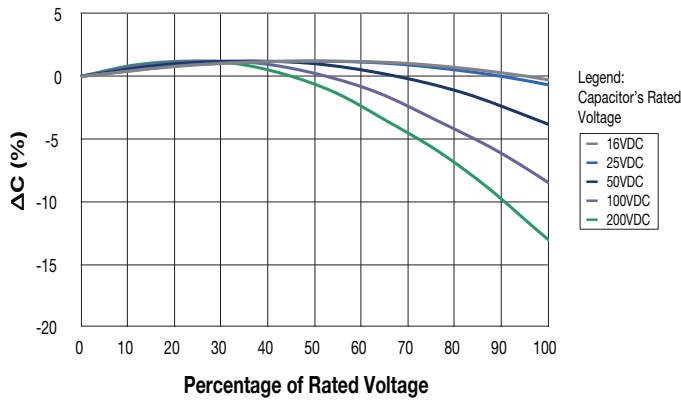

Typical Voltage Coefficient of Capacitance (COG Dielectric)

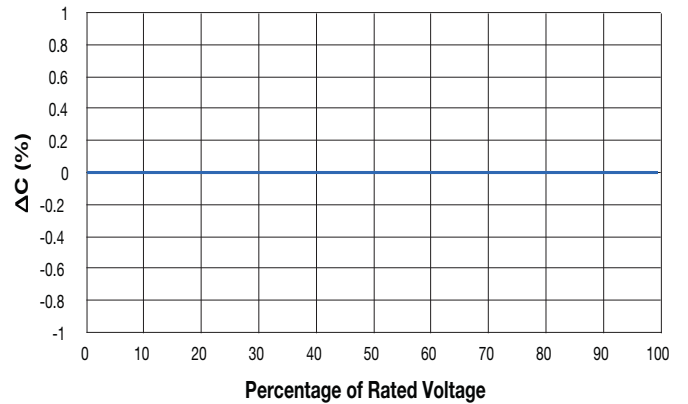

Typical RC vs Temperature (VHT Dielectric)

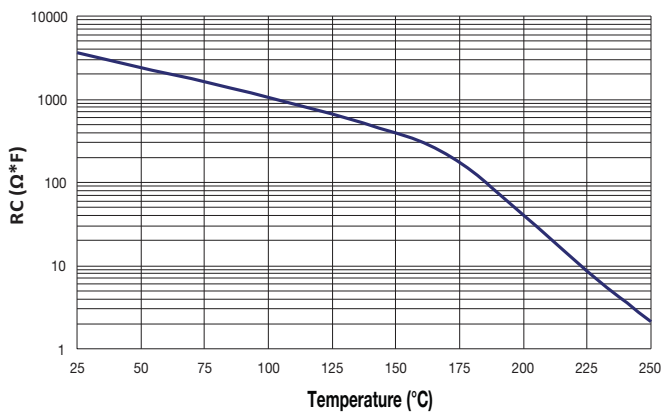

Typical RC vs Temperature (COG Dielectric)

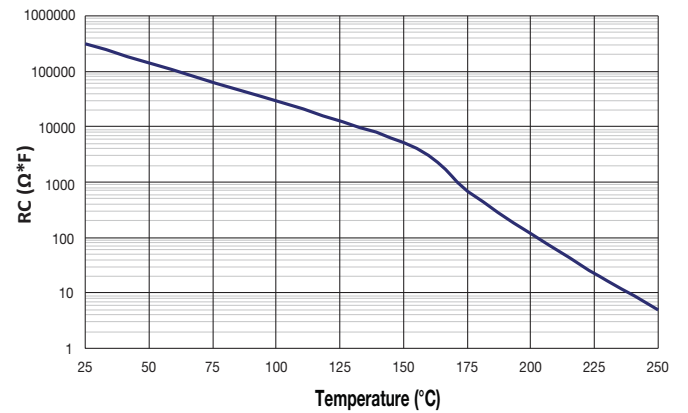

High Temperature MLCC

AT Series – 200°C & 250°C Rated



RELIABILITY

250°C Life Test @ 2x Rated Voltage (VHT Dielectric)

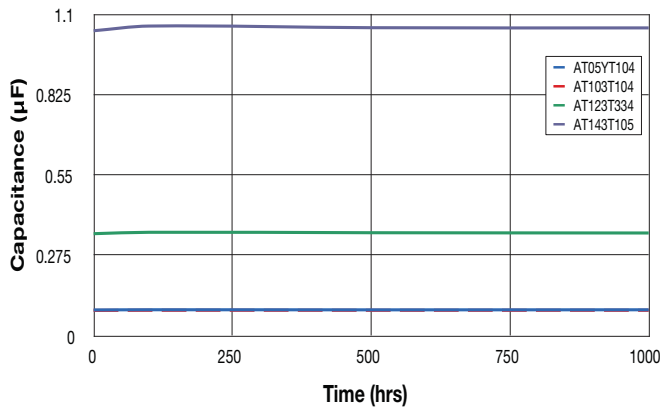

250°C Life Test @ 2x Rated Voltage (COG Dielectric)

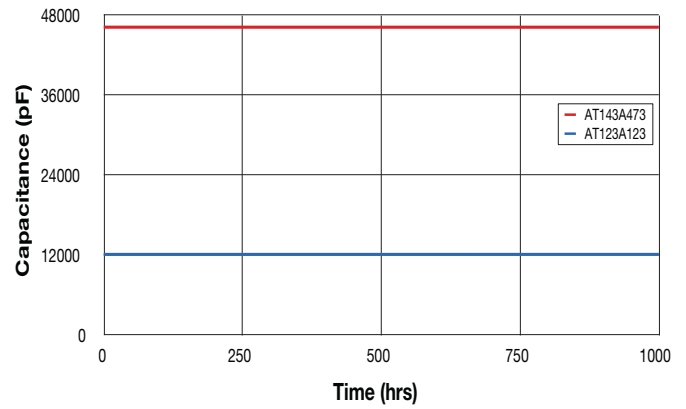

VHT - Failure Rate @ 90% Confidence Level (%/1000 hours)		
Temperature (°C)	50% Rated Voltage	100% Rated Voltage
200	0.002	0.017
250	0.026	0.210

*Typical 1210, 1812, 2225 Failure Rate Analysis based on 250°C testing and voltage ratings specified on the following page.

COG - Failure Rate @ 90% Confidence Level (%/1000 hours)		
Temperature (°C)	50% Rated Voltage	100% Rated Voltage
200	0.006	0.047
250	0.074	0.590

*Typical 1812 and 2225 Failure Rate Analysis based on 250°C testing and voltage ratings specified on the following page.

FREQUENCY RESPONSE

Impedance Frequency Response (VHT Dielectric)

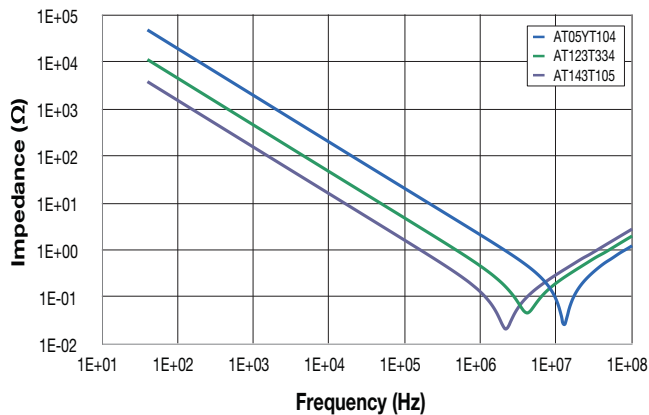

Impedance Frequency Response (COG Dielectric)

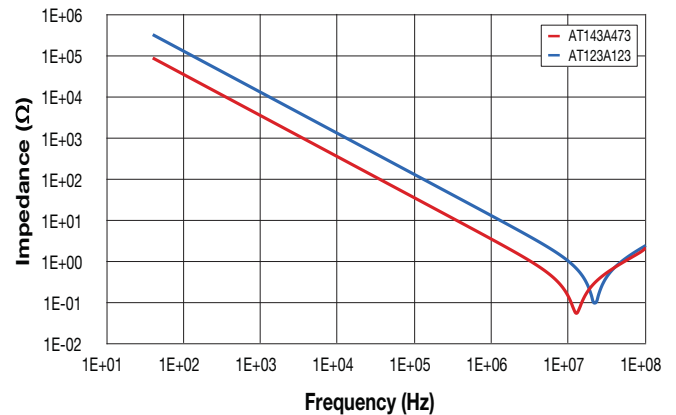

ESR Frequency Response (VHT Dielectric)

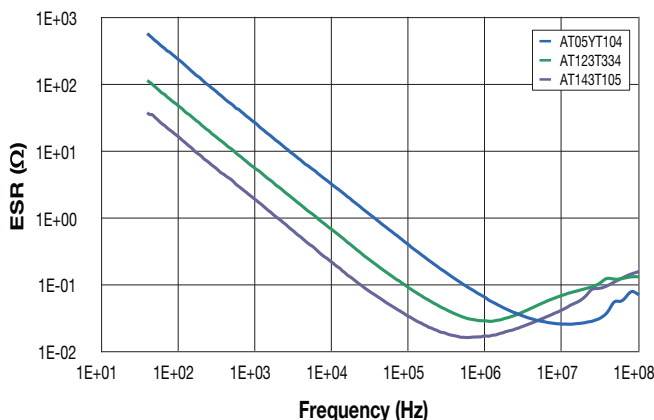

ESR Frequency Response (COG Dielectric)

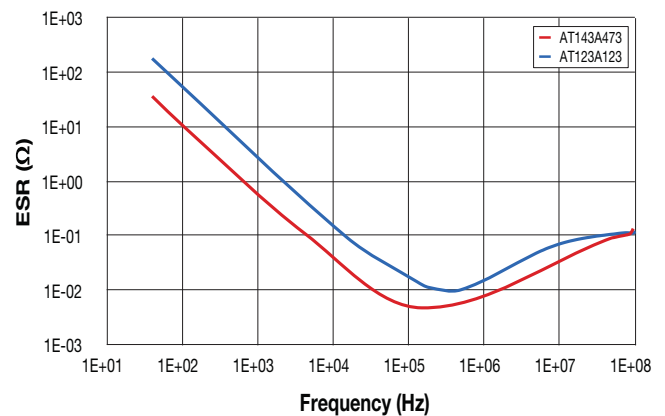

The Important Information/Disclaimer is incorporated in the catalog where these specifications came from or available online at www.avx.com/disclaimer/ by reference and should be reviewed in full before placing any order.

High Temperature MLCC

AT Series – 200°C & 250°C Rated



CAPACITANCE RANGE

PREFERRED SIZES ARE SHADED

VHT Temp. Coefficient: 4 200°C Rated

Case Size	AT03 = 0603	AT05 = 0805	AT06 = 1206	AT10 = 1210	AT12 = 1812	AT14 = 2225
Soldering	Reflow/Wave	Reflow/Wave	Reflow/Wave	Reflow Only	Reflow Only	Reflow Only
(L) Length	mm 1.60±0.15 (in.) (0.063±0.006)	2.01±0.20 (0.079±0.008)	3.20±0.20 (0.126±0.008)	3.20±0.20 (0.126±0.008)	4.50±0.30 (0.177±0.012)	5.72±0.25 (0.225±0.010)
(W) Width	mm 0.81±0.15 (in.) (0.032±0.006)	1.25±0.20 (0.049±0.008)	1.60±0.20 (0.063±0.008)	2.50±0.20 (0.098±0.008)	3.20±0.20 (0.126±0.008)	6.35±0.25 (0.250±0.010)
(T) Thickness	mm 1.02 (in.) (0.040)	1.30 (0.051)	1.52 (0.060)	1.70 (0.067)	2.54 (0.100)	2.54 (0.100)
(t) Terminal	min 0.25(0.010) max 0.75(0.030)	0.25(0.010) 0.75(0.030)	0.25(0.010) 0.75(0.030)	0.25(0.010) 0.75(0.030)	0.25(0.010) 1.02(0.040)	0.25(0.010) 1.02(0.040)
Rated Temp. (°C)	200	200	200	200	200	200
Temp. Coefficient	4	4	4	4	4	4
Voltage (V)	25	25 50	25 50	25 50	50	50
Cap (pF)	1000 102					
	1200 122					
	1500 152					
	1800 182					
	2200 222					
	2700 272					
	3300 332					
	3900 392					
	4700 472					
	5600 562					
Cap (µF)	6800 682					
	8200 822					
	0.010 103					
	0.012 123					
	0.015 153					
	0.018 183					
	0.022 223					
	0.027 273					
	0.033 333					
	0.039 393					
0.047 473						
0.056 563						
0.068 683						
0.082 823						
0.100 104						
0.120 124						
0.150 154						
0.180 184						
0.220 224						
0.270 274						
0.330 334						
0.390 394						
0.470 474						
0.560 564						
0.680 684						
0.820 824						
1.000 105						
Voltage (V)	25	25 50	25 50	25 50	50	50
Rated Temp. (°C)	200	200	200	200	200	200
Case Size	AT03 = 0603	AT05 = 0805	AT06 = 1206	AT10 = 1210	AT12 = 1812	AT14 = 2225

VHT Temp. Coefficient: T 250°C Rated

Case Size	AT03 = 0603	AT05 = 0805	AT06 = 1206	AT10 = 1210	AT12 = 1812	AT14 = 2225
Soldering	Reflow/Wave	Reflow/Wave	Reflow/Wave	Reflow Only	Reflow Only	Reflow Only
(L) Length	mm 1.60±0.15 (in.) (0.063±0.006)	2.01±0.20 (0.079±0.008)	3.20±0.20 (0.126±0.008)	3.20±0.20 (0.126±0.008)	4.50±0.30 (0.177±0.012)	5.72±0.25 (0.225±0.010)
(W) Width	mm 0.81±0.15 (in.) (0.032±0.006)	1.25±0.20 (0.049±0.008)	1.60±0.20 (0.063±0.008)	2.50±0.20 (0.098±0.008)	3.20±0.20 (0.126±0.008)	6.35±0.25 (0.250±0.010)
(T) Thickness	mm 1.02 (in.) (0.040)	1.30 (0.051)	1.52 (0.060)	1.70 (0.067)	2.54 (0.100)	2.54 (0.100)
(t) Terminal	min 0.25(0.010) max 0.75(0.030)	0.25(0.010) 0.75(0.030)	0.25(0.010) 0.75(0.030)	0.25(0.010) 0.75(0.030)	0.25(0.010) 1.02(0.040)	0.25(0.010) 1.02(0.040)
Rated Temp. (°C)	250	250	250	250	250	250
Temp. Coefficient	T	T	T	T	T	T
Voltage (V)	16	16 25	16 25	16 25	25	25
Cap (pF)	1000 102					
	1200 122					
	1500 152					
	1800 182					
	2200 222					
	2700 272					
	3300 332					
	3900 392					
	4700 472					
	5600 562					
Cap (µF)	6800 682					
	8200 822					
	0.010 103					
	0.012 123					
	0.015 153					
	0.018 183					
	0.022 223					
	0.027 273					
	0.033 333					
	0.039 393					
0.047 473						
0.056 563						
0.068 683						
0.082 823						
0.100 104						
0.120 124						
0.150 154						
0.180 184						
0.220 224						
0.270 274						
0.330 334						
0.390 394						
0.470 474						
0.560 564						
0.680 684						
0.820 824						
1.000 105						
Voltage (V)	16	16 25	16 25	16 25	25	25
Rated Temp. (°C)	250	250	250	250	250	250
Case Size	AT03 = 0603	AT05 = 0805	AT06 = 1206	AT10 = 1210	AT12 = 1812	AT14 = 2225

Voltage rating per table. Capacitance values specified at 25°C, derate capacitance value based on TCC and VCC Plots on page 107.

NOTE: Contact factory for non-specified capacitance values.

High Temperature MLCC

AT Series – 200°C & 250°C Rated



CAPACITANCE RANGE

PREFERRED SIZES ARE SHADED

BME COG Temp. Coefficient: 4 200°C Rated

Case Size		AT03=0603		AT05=0805		AT06=1206	
Soldering		Reflow/Wave		Reflow/Wave		Reflow/Wave	
(L) Length	mm	1.60±0.15		2.01±0.20		3.20±0.20	
	(in.)	(0.063±0.006)		(0.079±0.008)		(0.126±0.008)	
(W) Width	mm	0.81±0.15		1.25±0.20		1.60±0.20	
	(in.)	(0.032±0.006)		(0.049±0.008)		(0.063±0.008)	
(T) Thickness	mm	1.02		1.30		1.52	
	(in.)	(0.040)		(0.051)		(0.060)	
(t) Terminal	min	0.25(0.010)		0.25(0.010)		0.25(0.010)	
	max	0.75(0.030)		0.75(0.030)		0.75(0.030)	
Rated Temp. (°C)		200		200		200	
Temp. Coefficient		3		3		3	
Voltage (V)		25	50	25	50	25	50
Cap (pF)	39	390					
	47	470					
	56	560					
	68	680					
	82	820					
	100	101					
	120	121					
	150	151					
	180	181					
	220	221					
	270	271					
	330	331					
	390	391					
	470	471					
	560	561					
	680	681					
	820	821					
	1000	102					
	1200	122					
	1500	152					
	1800	182					
	2200	222					
	2700	272					
	3300	332					
	3900	392					
	4700	472					
	5600	562					
	6800	682					
	8200	822					
	0.010	103					
Cap (µF)	0.012	123					
	0.015	153					
	0.018	183					
	0.022	223					
	0.027	273					
	0.033	333					
	0.039	393					
	0.047	473					
	0.056	563					
	0.068	683					
	0.082	823					
	0.100	104					
Voltage (V)		25	50	25	50	25	50
Rated Temp. (°C)		200	200	200	200	200	200
Case Size		AT03=0603		AT05=0805		AT06=1206	

BME COG (Ni/Au) Temp. Coefficient: 5 250°C Rated

Case Size		AT03=0603		AT05=0805		AT06 = 1206	
Soldering		Reflow/Wave		Reflow/Wave		Reflow/Wave	
(L) Length	mm	1.60±0.15		2.01±0.20		3.20±0.20	
	(in.)	(0.063±0.006)		(0.079±0.008)		(0.126±0.008)	
(W) Width	mm	0.81±0.15		1.25±0.20		1.60±0.20	
	(in.)	(0.032±0.006)		(0.049±0.008)		(0.063±0.008)	
(T) Thickness	mm	1.02		1.30		1.52	
	(in.)	(0.040)		(0.051)		(0.060)	
(t) Terminal	min	0.25(0.010)		0.25(0.010)		0.25(0.010)	
	max	0.75(0.030)		0.75(0.030)		0.75(0.030)	
Rated Temp. (°C)		250		250		250	
Temp. Coefficient		5		5		5	
Voltage (V)		25		25		25	
Cap (pF)	39	390					
	47	470					
	56	560					
	68	680					
	82	820					
	100	101					
	120	121					
	150	151					
	180	181					
	220	221					
	270	271					
	330	331					
	390	391					
	470	471					
	560	561					
	680	681					
	820	821					
	1000	102					
	1200	122					
	1500	152					
	1800	182					
	2200	222					
	2700	272					
	3300	332					
	3900	392					
	4700	472					
	5600	562					
	6800	682					
	8200	822					
	0.010	103					
Cap (µF)	0.012	123					
	0.015	153					
	0.018	183					
	0.022	223					
	0.027	273					
	0.033	333					
	0.039	393					
	0.047	473					
	0.056	563					
	0.068	683					
	0.082	823					
	0.100	104					
Voltage (V)		25		25		25	
Rated Temp. (°C)		250		250		250	
Case Size		AT03=0603		AT05=0805		AT06=1206	

Voltage rating per table. Capacitance values specified at 25°C, derate capacitance value based on TCC and VCC Plots on page 107.

NOTE: Contact factory for non-specified capacitance values.



The Important Information/Disclaimer is incorporated in the catalog where these specifications came from or available online at www.avx.com/disclaimer/ by reference and should be reviewed in full before placing any order.

High Temperature MLCC

AT Series – 200°C & 250°C Rated



CAPACITANCE RANGE

PREFERRED SIZES ARE SHADED

PME COG Temp. Coefficient: 2 200°C Rated

Case Size	AT05 = 0805	AT06 = 1206	AT10 = 1210	AT12 = 1812	AT14 = 2225
Soldering	Reflow/Wave	Reflow/Wave	Reflow Only	Reflow Only	Reflow Only
(L) Length	mm 2.01 ± 0.20 (in.) (0.079 ± 0.008)	3.20 ± 0.20 (0.126 ± 0.008)	3.20 ± 0.20 (0.126 ± 0.008)	4.50 ± 0.30 (0.177 ± 0.012)	2.75 ± 0.25 (0.225 ± 0.010)
(W) Width	mm 1.25 ± 0.20 (in.) (0.049 ± 0.008)	1.60 ± 0.20 (0.063 ± 0.008)	2.50 ± 0.20 (0.098 ± 0.008)	3.20 ± 0.20 (0.126 ± 0.008)	6.35 ± 0.25 (0.250 ± 0.010)
(T) Thickness	mm 1.30 (in.) (0.051)	1.52 (0.060)	1.70 (0.067)	2.54 (0.100)	2.54 (0.100)
(t) Terminal	min 0.25 (0.010) max 0.75 (0.030)	0.25 (0.010) 0.75 (0.030)	0.25 (0.010) 0.75 (0.030)	0.25 (0.010) 1.02 (0.040)	0.25 (0.010) 1.02 (0.040)
Rated Temp. (°C)	200	200	200	200	200
Temp. Coefficient	2	2	2	2	2
Voltage (V)	50	50	50	50	50
Cap (pF)	100 101				
	120 121				
	150 151				
	180 181				
	220 221				
	270 271				
	330 331				
	390 391				
	470 471				
	560 561				
	680 681				
	820 821				
	1000 102				
	1200 122				
	1500 152				
	1800 182				
	2200 222				
	2700 272				
3300 332					
3900 392					
4700 472					
5600 562					
6800 682					
8200 822					
Cap (µF)	0.010 103				
	0.012 123				
	0.015 153				
	0.018 183				
	0.022 223				
	0.027 273				
	0.033 333				
	0.039 393				
	0.047 473				
	0.056 563				
0.068 683					
0.082 823					
0.100 104					
Voltage (V)	50	50	50	50	50
Rated Temp. (°C)	200	200	200	200	200
Case Size	AT05 = 0805	AT06 = 1206	AT10 = 1210	AT12 = 1812	AT14 = 2225

PME COG Temp. Coefficient: A 250°C Rated

Case Size	AT05 = 0805	AT06 = 1206	AT10 = 1210	AT12 = 1812	AT14 = 2225
Soldering	Reflow/Wave	Reflow/Wave	Reflow Only	Reflow Only	Reflow Only
(L) Length	mm 2.01 ± 0.20 (in.) (0.079 ± 0.008)	3.20 ± 0.20 (0.126 ± 0.008)	3.20 ± 0.20 (0.126 ± 0.008)	4.50 ± 0.30 (0.177 ± 0.012)	2.75 ± 0.25 (0.225 ± 0.010)
(W) Width	mm 1.25 ± 0.20 (in.) (0.049 ± 0.008)	1.60 ± 0.20 (0.063 ± 0.008)	2.50 ± 0.20 (0.098 ± 0.008)	3.20 ± 0.20 (0.126 ± 0.008)	6.35 ± 0.25 (0.250 ± 0.010)
(T) Thickness	mm 1.30 (in.) (0.051)	1.52 (0.060)	1.70 (0.067)	2.54 (0.100)	2.54 (0.100)
(t) Terminal	min 0.25 (0.010) max 0.75 (0.030)	0.25 (0.010) 0.75 (0.030)	0.25 (0.010) 0.75 (0.030)	0.25 (0.010) 1.02 (0.040)	0.25 (0.010) 1.02 (0.040)
Rated Temp. (°C)	250	250	250	250	250
Temp. Coefficient	A	A	A	A	A
Voltage (V)	25	25	25	25	25
Cap (pF)	100 101				
	120 121				
	150 151				
	180 181				
	220 221				
	270 271				
	330 331				
	390 391				
	470 471				
	560 561				
	680 681				
	820 821				
	1000 102				
	1200 122				
	1500 152				
	1800 182				
	2200 222				
	2700 272				
3300 332					
3900 392					
4700 472					
5600 562					
6800 682					
8200 822					
Cap (µF)	0.010 103				
	0.012 123				
	0.015 153				
	0.018 183				
	0.022 223				
	0.027 273				
	0.033 333				
	0.039 393				
	0.047 473				
	0.056 563				
0.068 683					
0.082 823					
0.100 104					
Voltage (V)	25	25	25	25	25
Rated Temp. (°C)	250	250	250	250	250
Case Size	AT05 = 0805	AT06 = 1206	AT10 = 1210	AT12 = 1812	AT14 = 2225

Voltage rating per table. Capacitance values specified at 25°C, derate capacitance value based on TCC and VCC Plots on page 107.

NOTE: Contact factory for non-specified capacitance values.

X-ON Electronics

Largest Supplier of Electrical and Electronic Components

Click to view similar products for [Multilayer Ceramic Capacitors MLCC - SMD/SMT category:](#)

Click to view products by [Kyocera AVX manufacturer:](#)

Other Similar products are found below :

[D55342E07B523DR-T/R](#) [NCA1206X7R104K16TRPF](#) [NIN-FB391JTRF](#) [NIN-FC2R7JTRF](#) [NMC0402NPO220J50TRPF](#)
[NMC0402X5R105K6.3TRPF](#) [NMC0402X5R224K6.3TRPF](#) [NMC0402X7R103J25TRPF](#) [NMC0402X7R153K16TRPF](#)
[NMC0402X7R392K50TRPF](#) [NMC0603NPO1R8C50TRPF](#) [NMC0603NPO201J50TRPF](#) [NMC0603NPO330G50TRPF](#)
[NMC0603NPO331F50TRPF](#) [NMC0603X5R475M6.3TRPF](#) [NMC0805NPO220J100TRPF](#) [NMC0805NPO270J50TRPF](#)
[NMC0805NPO681F50TRPF](#) [NMC0805NPO820J50TRPF](#) [NMC1206X7R102K50TRPF](#) [NMC1210Y5V105Z50TRPLPF](#) [NMC-](#)
[L0402NPO7R0C50TRPF](#) [NMC-L0603NPO2R2B50TRPF](#) [NMC-P1206X7R103K1KVTRPLPF](#) [NMC-Q0402NPO8R2D200TRPF](#)
[C1206C101J1GAC](#) [C1608C0G2A221J](#) [C1608X7R1E334K](#) [C2012C0G2A472J](#) [2220J2K00562KXT](#) [KHC201E225M76N0T00](#)
[1812J2K00332KXT](#) [CCR06CG153FSV](#) [CDR14BP471CJUR](#) [CDR31BX103AKWR](#) [CDR33BX683AKUS](#) [CGA2B2C0G1H010C](#)
[CGA2B2C0G1H040C](#) [CGA2B2C0G1H050C](#) [CGA2B2C0G1H060D](#) [CGA2B2C0G1H070D](#) [CGA2B2C0G1H120J](#) [CGA2B2C0G1H151J](#)
[CGA2B2C0G1H1R5C](#) [CGA2B2C0G1H2R2C](#) [CGA2B2C0G1H390J](#) [CGA2B2C0G1H391J](#) [CGA2B2C0G1H3R3C](#) [CGA2B2C0G1H680J](#)
[CGA2B2C0G1H6R8D](#)