

How to Order

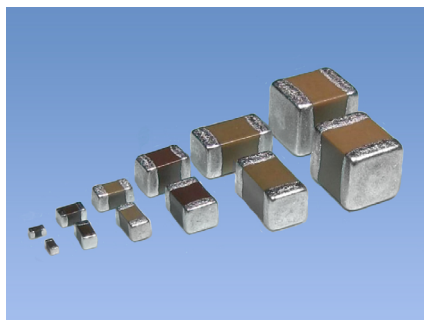

■ Features

- Kyocera's series of Multilayer Ceramic Chip Capacitors are designed to meet a wide variety of needs. We offer a complete range of products for both general and specialized applications.
- We have a network worldwide in order to supply our global customer bases quickly and efficiently.
- All our products are highly reliable due to their monolithic structure of high-purity and superfine uniform ceramics and their integral internal electrodes.
- Our stringent quality control in every phase of production from material procurement to shipping ensures consistent manufacturing and superior quality.
- Kyocera components are available in a wide choice of dimensions, temperature characteristics, rated voltages, and terminations to meet specific configurational requirements.

■ KYOCERA PART NUMBER

CM **03** **X5R** **225** **M** **06** **A** **H** □□□
 ① ② ③ ④ ⑤ ⑥ ⑦ ⑧ OPTION :

Above digits are used to track individual specification or thickness.

(Example)

- ① Series : CM Series(General)
- ② Size : 0201
- ③ Dielectric : X5R
- ④ Capacitance : 2.2μF
- ⑤ Tolerance : ±20%
- ⑥ Voltage : 6.3Vdc
- ⑦ Termination : Sn
- ⑧ Packaging : Cavity pitch 2mm / Reel Size φ180

① Series Code

CODE	Type
CM	General
CT	Low Profile
CU	High-Q
AR	Automotive
KNH	Three Terminal Capacitors

② Size Code

CODE	EIA	JIS
02	01005	0402
03	0201	0603
05	0402	1005
105	0603	1608
21	0805	2012
316	1206	3216
32	1210	3225

③ Dielectric Code

Temperature Compensation Type			
CODE	Temperature Range (°C)	ppm/°C	
CG	-55 to 125	0	±30
CH			±60

- All parts of COG will be marked as "CG" but will conform to the above table.
- Temperature coefficients are determined by calculation based on measurement at 20°C and 85°C.

High Dielectric Constant Type			
CODE	Temperature Range (°C)	ΔC (%)	Standard Temperature (°C)
X5R	-55 to 85	±15	25
X6S	-55 to 105	±22	
X6T		+22/-33	
X7R		±15	
X7S	-55 to 125	±22	
X7T		+22/-33	

④ Capacitance Code

Capacitance expressed in pF.
Two significant digits plus number of zeros.
For Values < 10pF, Letter R denotes decimal point,
102=1,000pF=1nF

(Example)

CODE	Capacitance
R50	0.5pF
1R0	1pF
100	10pF
101	100pF
102	1nF
103	10nF
104	100nF
105	1μF
106	10μF
107	100μF

⑤ Tolerance Code

Temperature Compensation Type (COG)	
CODE	Tolerance
A*	±0.05pF
B	±0.1pF
C	±0.25pF
D	±0.5pF
G*	±2%
J	±5%
K	±10%

* : Option

⑥ Voltage Code

CODE	Rated Voltage
02	2.5Vdc
04	4Vdc
06	6.3Vdc
10	10Vdc
16	16Vdc
25	25Vdc
35	35Vdc
50	50Vdc
100	100Vdc

⑦ Termination Code

CODE	Termination
A	Nickel Barrier/ Tin

• Please contact us if Au termination is needed.

⑧ Packaging Code

CODE	Size Code	Cavity pitch	Reel size
T	105 to 32	4mm	φ180
H	02 to 05	2mm	
Q	03/05	1mm	
P	02	1mm	
L	105 to 32	4mm	φ330
N	02 to 05	2mm	
W	03/05	1mm	

High Dielectric Constant Type (X5R/X6S/X6T/X7R/X7S/X7T)	
CODE	Tolerance
J*	±5%
K	±10%
M	±20%

* : Option

Dimension

■CM/CT/CU/AR Series (Two Terminal Capacitors)

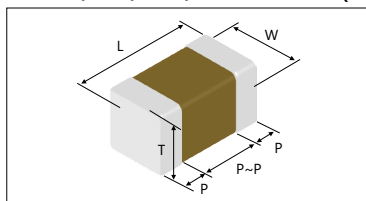

■Packaging Code

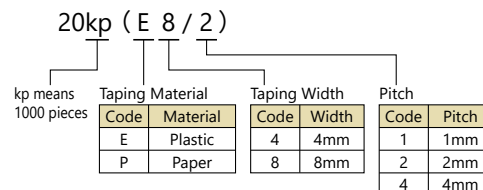

Size	Code		Dimension Code	Dimension (mm)						Quantity per reel	
	EIA	JIS		L	W	T	P min.	P max.	P to P min.	φ180 Reel	φ330 Reel
02	01005	0402	A	0.4±0.02	0.2±0.02	0.2±0.02	0.07	0.14	0.13	40kp(E4/1) 20kp(P8/2)	— 80kp(P8/2)
03	0201	0603	A	0.6±0.05	0.3±0.05	0.22 max.	0.13	0.23	0.19	30kp(P8/1) 15kp(P8/2)	150kp(P8/1) 50kp(P8/2)
			B			0.3±0.03					
			C			0.3±0.05					
			D			0.22 max.					
			E			0.3±0.09					
			F			0.5±0.05					
05	0402	1005	A	1.0±0.2	0.5±0.2	0.33 max.	0.15	0.35	0.3	20kp(P8/1) 10kp(P8/2)	100kp(P8/1) 50kp(P8/2)
			B			0.5±0.05					
			C			0.22 max.					
			D			0.5±0.15					
			E			0.33 max.					
			F			0.5 max.					
			G			0.55 max.					
			H			0.5±0.2					
			J			0.8 max.					
			105			0603					
B	0.8±0.1										
C	1.6±0.15	0.8±0.15	0.8±0.15								
D	1.6±0.2	0.8±0.2	0.8±0.2								
21	0805	2012	A	2.0±0.1	1.25±0.1	1.25±0.1	0.2	0.75	0.7	3kp(E8/4) 4kp(P8/4)	10kp(E8/4) 10kp(P8/4)
			B	2.0±0.15	1.25±0.15	0.95 max.					
			C	2.0±0.2	1.25±0.2	0.95 max.					
			D			1.25±0.2					
316	1206	3216	A	3.2±0.2	1.6±0.2	0.95 max.	0.3	0.85	1.4	4kp(P8/4) 2.5kp(E8/4)	— 5kp(E8/4)
			B	1.6±0.15	1.6±0.15						
			C	1.6±0.2	1.6±0.2						
			D	3.2±0.3	1.6±0.3	1.6±0.3					
32	1210	3225	A	3.2±0.3	2.5±0.2	2.5±0.2	0.3	1.0	1.4	1kp(E8/4)	4kp(E8/4)

■KNH Series (Three Terminal Capacitors)

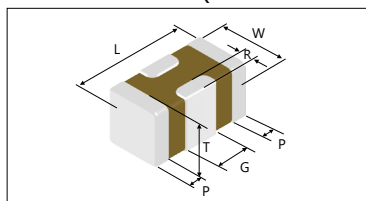

Size	Code		Dimension Code	Dimension (mm)						Packaging	
	EIA	JIS		L	W	T	G	P	R	φ180 Reel	φ330 Reel
KNH 05	0402	1005	A	1.0±0.1	0.5±0.2	0.5 max.	0.3±0.1	0.15±0.1	≥0.05	10kp(P8/2)	—
			B	1.0±0.15	0.5±0.15	0.5±0.15					
			C	1.0±0.2	0.5±0.2	0.5±0.2					

■ Features

We offer a diverse product line ranging from ultra-compact (0.4×0.2mm) to large (3.2×2.5mm) components configured for a variety of temperature characteristics, rated voltages, and packages. We offer the choice and flexibility for almost any applications.

■ Applications

This standard type is ideal for use in a wide range of applications, from commercial to industrial equipment.

Temperature Compensation Dielectric

● Capacitance chart ■ Standard Spec.1

Size (EIA Code)	CM02 (01005)	
	16	25
Rated Voltage(Vd.c)		
Capacitance		
1R0	1 pF	
1R5	1.5 pF	
2R0	2 pF	
3R0	3 pF	
4R0	4 pF	
5R0	5 pF	
6R0	6 pF	
7R0	7 pF	
8R0	8 pF	A
9R0	9 pF	
100	10 pF	
120	12 pF	
150	15 pF	
180	18 pF	
220	22 pF	
270	27 pF	
330	33 pF	
390	39 pF	
470	47 pF	
560	56 pF	
680	68 pF	
820	82 pF	
101	100 pF	
121	120 pF	
151	150 pF	
181	180 pF	
221	220 pF	A

Please contact for capacitance value other than standard.

Please refer to [here](#) for the test method and specifications of Standard Specification 1.

Alphabets in capacitance chart denote dimensions. Please refer to the below table for detail.

(Example) In case of "A" for CM02;

L: 0.4±0.02mm, W: 0.2±0.02mm, T: 0.2±0.02mm

Size	Dimension Code	Dimension (mm)			Packaging									
		L	W	T	φ180 Reel					φ330 Reel				
					Code	Quantity (pcs.)	Taping Material	Taping Width (mm)	Cavity Pitch (mm)	Code	Quantity (pcs.)	Taping Material	Taping Width (mm)	Cavity Pitch (mm)
02	A	0.4±0.02	0.2±0.02	0.2±0.02	P	40,000	Plastic	4	1	—	—	—	—	—
					H	20,000	Paper	8	2	N	80,000	Paper	8	2

X5R Dielectric

●Capacitance chart ■ Standard Spec.1 ■ Standard Spec.2 ▨ Optional Spec.

Size (EIA Code)	CM02 (01005)			CM03 (0201)					CM05 (0402)					
	6.3	10	16	4	6.3	10	16	25	4	6.3	10	16	25	35
Rated Voltage (Vdc)														
Capacitance														
101 100 pF														
151 150 pF														
221 220 pF														
331 330 pF														
471 470 pF														
681 680 pF														
102 1000 pF														
152 1500 pF														
222 2200 pF														
332 3300 pF														
472 4700 pF														
682 6800 pF														
103 10000 pF														
153 15000 pF														
223 22000 pF														
333 33000 pF														
473 47000 pF														
683 68000 pF														
104 0.1 μF														
224 0.22 μF														
474 0.47 μF														
105 1 μF														
225 2.2 μF														
475 4.7 μF														
106 10 μF														
156 15 μF														
226 22 μF														
476 47 μF														

Size (EIA Code)	CM105 (0603)					CM21 (0805)					CM316 (1206)				CM32 (1210)				
	6.3	10	16	25	35	4	6.3	10	16	25	50	16	25	50	100	16	25	50	
Rated Voltage (Vdc)																			
Capacitance																			
105 1 μF																			
225 2.2 μF																			
475 4.7 μF																			
106 10 μF																			
226 22 μF																			
476 47 μF																			
107 100 μF																			

Please contact for capacitance value other than standard.

Please refer to [here](#) for the test method and specifications of Standard Specification 1.

Please refer to [here](#) for the test method and specifications of Standard Specification 2.

Tan δ Code	Tan δ
3	5.0% max.
7	10.0% max.
8	12.5% max.
9	15.0% max.
10	20.0% max.

Two digits alphanumeric in capacitance chart denote dimensions and tan δ. Please refer to the above table for detail.

(Example) In case of "B7" for CM03;

L: 0.6±0.03mm, W: 0.3±0.03mm, T: 0.3±0.03mm, Tanδ: 10.0% max.

Size	Dimension Code	Dimension (mm)			Packaging													
		L	W	T	φ180 Reel					φ330 Reel								
					Code	Quantity (pcs.)	Taping Material	Taping Width (mm)	Cavity Pitch (mm)	Code	Quantity (pcs.)	Taping Material	Taping Width (mm)	Cavity Pitch (mm)				
02	A	0.4±0.02	0.2±0.02	0.2±0.02	P	40,000	Plastic	4	1	—	—	—	—	—				
					H	20,000	Paper	8	2	N	80,000	Paper	8	2				
03	B	0.6±0.03	0.3±0.03	0.3±0.03	Q	30,000	Paper	8	1	W	150,000	Paper	8	1				
					H	15,000	Paper	8	2	N	50,000	Paper	8	2				
	C	0.6±0.05	0.3±0.05	0.3±0.05	Q	30,000	Paper	8	1	W	150,000	Paper	8	1				
					H	15,000	Paper	8	2	N	50,000	Paper	8	2				
	E	0.6±0.09	0.3±0.09	0.3±0.09	H	15,000	Paper	8	2	N	50,000	Paper	8	2				
					F	0.6±0.09	0.3±0.09	0.5±0.05	H	10,000	Paper	8	2	—	—	—		
05	B	1.0±0.05	0.5±0.05	0.5±0.05	Q	20,000	Paper	8	1	W	100,000	Paper	8	1				
					H	10,000	Paper	8	2	N	50,000	Paper	8	2				
	D	1.0±0.15	0.5±0.15	0.5±0.15	H	10,000	Paper	8	2	N	40,000	Paper	8	2				
	G	1.0±0.2	0.5±0.2	0.55 max.	H	10,000	Paper	8	2	N	50,000	Paper	8	2				
	H	1.0±0.2	0.5±0.2	0.5±0.2	H	10,000	Paper	8	2	N	40,000	Paper	8	2				
J	1.0±0.2	0.5±0.2	0.8 max.	H	10,000	Paper	8	2	N	30,000	Paper	8	2					
105	B	1.6±0.1	0.8±0.1	0.8±0.1	T	4,000	Paper	8	4	L	10,000	Paper	8	4				
					C	1.6±0.15	0.8±0.15	0.8±0.15	T	4,000	Paper	8	4	L	10,000	Paper	8	4
					D	1.6±0.2	0.8±0.2	0.8±0.2	T	4,000	Paper	8	4	L	10,000	Paper	8	4
21	A	2.0±0.1	1.25±0.1	1.25±0.1	T	3,000	Plastic	8	4	L	10,000	Plastic	8	4				
					D	2.0±0.2	1.25±0.2	1.25±0.2	T	3,000	Plastic	8	4	L	10,000	Plastic	8	4
316	B	3.2±0.2	1.6±0.15	1.6±0.15	T	2,500	Plastic	8	4	L	5,000	Plastic	8	4				
					C	3.2±0.2	1.6±0.2	1.6±0.2	T	2,500	Plastic	8	4	L	5,000	Plastic	8	4
32	A	3.2±0.3	2.5±0.2	2.5±0.2	T	1,000	Plastic	8	4	L	4,000	Plastic	8	4				

X6S/X6T Dielectric

●Capacitance chart ■ Standard Spec.2 ▨ Optional Spec.

Size (EIA Code)	X6S																
	CM03 (0201)				CM05 (0402)					CM105 (0603)				CM21 (0805)			
Rated Voltage (Vdc) Capacitance	2.5	4	6.3	10	4	6.3	10	16	25	4	6.3	10	16	4	6.3	10	16
104 0.1 μF																	
224 0.22 μF																	
474 0.47 μF							▨ B8	▨ B8									
105 1 μF		■ E10	■ E10	▨ E10													
225 2.2 μF																	
475 4.7 μF	▨ F9						▨ D8/H8	▨ H8									
106 10 μF																	
226 22 μF						▨ B8											
476 47 μF																	
107 100 μF																	

Size (EIA Code)	X6T		
	CM03 (0201)		
Rated Voltage (Vdc) Capacitance	2.5	4	10
224 0.22 μF			▨ E8
474 0.47 μF			
105 1 μF	▨ C8		
225 2.2 μF	▨ E8	▨ E8	
475 4.7 μF			
106 10 μF			

Please contact for capacitance value other than standard.

Please refer to [here](#) for the test method and specifications of Standard Specification 2.

Two digits alphanumeric in capacitance chart denote dimensions and tan δ. Please refer to the above table for detail.

(Example) In case of "D9" for CM105;

L: 1.6±0.2mm, W: 0.8±0.2mm, T: 0.8±0.2mm, Tanδ: 15.0% max.

Tan δ Code	Tan δ
7	10.0% max.
8	12.5% max.
9	15.0% max.
10	20.0% max.

Size	Dimension Code	Dimension (mm)			Packaging									
		L	W	T	φ180 Reel					φ330 Reel				
					Code	Quantity (pcs.)	Taping Material	Taping Width (mm)	Cavity Pitch (mm)	Code	Quantity (pcs.)	Taping Material	Taping Width (mm)	Cavity Pitch (mm)
03	C	0.6±0.05	0.3±0.05	0.3±0.05	Q	30,000	Paper	8	1	W	150,000	Paper	8	1
					H	15,000	Paper	8	2	N	50,000	Paper	8	2
	E	0.6±0.09	0.3±0.09	0.3±0.09	H	15,000	Paper	8	2	N	50,000	Paper	8	2
					F	10,000	Paper	8	2	—	—	—	—	—
05	B	1.0±0.05	0.5±0.05	0.5±0.05	Q	20,000	Paper	8	1	W	100,000	Paper	8	1
					H	10,000	Paper	8	2	N	50,000	Paper	8	2
	D	1.0±0.15	0.5±0.15	0.5±0.15	H	10,000	Paper	8	2	N	40,000	Paper	8	2
					H	10,000	Paper	8	2	N	50,000	Paper	8	2
	G	1.0±0.2	0.5±0.2	0.5±0.2	H	10,000	Paper	8	2	N	40,000	Paper	8	2
					H	10,000	Paper	8	2	N	50,000	Paper	8	2
J	1.0±0.2	0.5±0.2	0.8 max.	H	10,000	Paper	8	2	N	30,000	Paper	8	2	
105	D	1.6±0.2	0.8±0.2	0.8±0.2	T	4,000	Paper	8	4	L	10,000	Paper	8	4
21	D	2.0±0.2	1.25±0.2	1.25±0.2	T	3,000	Plastic	8	4	L	10,000	Plastic	8	4

X7R Dielectric

●Capacitance chart ■ Standard Spec.1 □ Standard Spec.2 ▨ Optional Spec.

Size (EIA Code)	CM02 (01005)	CM05 (0402)		CM105 (0603)		CM21 (0805)			
	16	6.3	25	6.3	25	6.3	16	25	50
Rated Voltage (Vdc)	16	6.3	25	6.3	25	6.3	16	25	50
Capacitance	16	6.3	25	6.3	25	6.3	16	25	50
101	100 pF	■ A8							
151	150 pF	■ A8							
221	220 pF	■ A8							
331	330 pF	■ A8							
471	470 pF	■ A8							
681	680 pF	■ A8							
102	1000 pF	■ A8							
152	1500 pF	■ A8							
222	2200 pF	■ A8							
332	3300 pF	■ A8							
472	4700 pF	■ A8							
682	6800 pF	■ A8							
103	10000 pF	■ A8							
153	15000 pF	■ A8							
223	22000 pF	■ A8							
333	33000 pF	■ A8							
473	47000 pF	■ A8							
683	68000 pF	■ A8							
104	0.1 μF		■ B8						
224	0.22 μF		▨ B8						
474	0.47 μF		▨ B8		□ B3				■ D3
105	1 μF				■ C8			■ D8	■ D8
225	2.2 μF							■ D8	■ D8
475	4.7 μF							■ D8	■ D8
106	10 μF							■ D8	■ D8

Size (EIA Code)	CM316 (1206)					CM32 (1210)		
	6.3	10	16	25	50	16	25	50
Rated Voltage (Vdc)	6.3	10	16	25	50	16	25	50
Capacitance	6.3	10	16	25	50	16	25	50
225	2.2 μF					□ C3		
475	4.7 μF							
106	10 μF			■ C8	□ C3		■ A8	■ A3
226	22 μF	■ C8	■ C5			■ A8	■ A8	■ A3

Please contact for capacitance value other than standard.

Please refer to [here](#) for the test method and specifications of Standard Specification 1.

Please refer to [here](#) for the test method and specifications of Standard Specification 2.

Two digits alphanumeric in capacitance chart denote dimensions and tan δ. Please refer to the above table for detail.

(Example) In case of "A8" for CM02;

L: 0.4±0.02mm, W: 0.2±0.02mm, T: 0.2±0.02mm, Tanδ: 12.5% max.

Tan δ Code	Tan δ
3	5.0% max.
5	7.5% max.
8	12.5% max.

Size	Dimension Code	Dimension (mm)			Packaging									
		L	W	T	φ180 Reel					φ330 Reel				
					Code	Quantity (pcs.)	Taping Material	Taping Width (mm)	Cavity Pitch (mm)	Code	Quantity (pcs.)	Taping Material	Taping Width (mm)	Cavity Pitch (mm)
02	A	0.4±0.02	0.2±0.02	0.2±0.02	P	40,000	Plastic	4	1	—	—	—	—	—
					H	20,000	Paper	8	2	N	80,000	Paper	8	2
					Q	20,000	Paper	8	1	W	100,000	Paper	8	1
05	B	1.0±0.05	0.5±0.05	0.5±0.05	H	10,000	Paper	8	2	N	50,000	Paper	8	2
					T	4,000	Paper	8	4	L	10,000	Paper	8	4
105	C	1.6±0.1	0.8±0.1	0.8±0.1	T	4,000	Paper	8	4	L	10,000	Paper	8	4
					T	4,000	Paper	8	4	L	10,000	Paper	8	4
21	D	2.0±0.2	1.25±0.2	1.25±0.2	T	3,000	Plastic	8	4	L	10,000	Plastic	8	4
316	C	3.2±0.2	1.6±0.2	1.6±0.2	T	2,500	Plastic	8	4	L	5,000	Plastic	8	4
32	A	3.2±0.3	2.5±0.2	2.5±0.2	T	1,000	Plastic	8	4	L	4,000	Plastic	8	4

X7S/X7T Dielectric

•Capacitance chart Standard Spec.1 Standard Spec.2 Optional Spec.

Size (EIA Code)	X7S							X7T					
	CM03 (0201)	CM05 (0402)		CM21 (0805)	CM316 (1206)		CM03 (0201)	CM05 (0402)	CM105 (0603)		CM21 (0805)		
Rated Voltage (Vdc) Capacitance	6.3	4	6.3	10	100	10	100	6.3	10	6.3	10	6.3	10
104 0.1 μF	B7												
224 0.22 μF													
474 0.47 μF													
105 1 μF		B8	B8		D3			E8					
225 2.2 μF		D3	D3	D3			C3						
475 4.7 μF							D3		H8			D8	
106 10 μF										D9	D9		
226 22 μF						C5						D8	D8

Please contact for capacitance value other than standard.

Please refer to [here](#) for the test method and specifications of Standard Specification 1.

Please refer to [here](#) for the test method and specifications of Standard Specification 2.

Two digits alphanumeric in capacitance chart denote dimensions and tan δ. Please refer to the above table for detail.

(Example) In case of "D9" for CM105;

L: 1.6±0.2mm, W: 0.8±0.2mm, T: 0.8±0.2mm, Tanδ: 15.0% max.

Tan δCode	Tan δ
3	5.0% max.
5	7.5% max.
7	10.0% max.
8	12.5% max.
9	15.0% max.

Size	Dimension Code	Dimension (mm)			Packaging									
		L	W	T	φ180 Reel					φ330 Reel				
					Code	Quantity (pcs.)	Taping Material	Taping Width (mm)	Cavity Pitch (mm)	Code	Quantity (pcs.)	Taping Material	Taping Width (mm)	Cavity Pitch (mm)
03	B	0.6±0.03	0.3±0.03	0.3±0.03	Q	30,000	Paper	8	1	W	150,000	Paper	8	1
					H	15,000	Paper	8	2	N	50,000	Paper	8	2
	E	0.6±0.09	0.3±0.09	0.3±0.09	H	15,000	Paper	8	2	N	50,000	Paper	8	2
05	B	1.0±0.05	0.5±0.05	0.5±0.05	Q	20,000	Paper	8	1	W	100,000	Paper	8	1
					H	10,000	Paper	8	2	N	50,000	Paper	8	2
	D	1.0±0.15	0.5±0.15	0.5±0.15	H	10,000	Paper	8	2	N	40,000	Paper	8	2
	H	1.0±0.2	0.5±0.2	0.5±0.2	H	10,000	Paper	8	2	N	40,000	Paper	8	2
105	D	1.6±0.2	0.8±0.2	0.8±0.2	T	4,000	Paper	8	4	L	10,000	Paper	8	4
21	D	2.0±0.2	1.25±0.2	1.25±0.2	T	3,000	Plastic	8	4	L	10,000	Plastic	8	4
316	C	3.2±0.2	1.6±0.2	1.6±0.2	T	2,500	Plastic	8	4	L	5,000	Plastic	8	4
	D	3.2±0.3	1.6±0.3	1.6±0.3	T	2,000	Plastic	8	4	—	—	—	—	—

Test Conditions and Standards

Test Conditions and Specifications for Temperature Compensation Type (CA Characteristics) CM /CT /CU Series (Standard Spec.1)

Test Items		Test Conditions (Complies with JIS C5101)	Specifications								
Capacitance Value (C)		<table border="1"> <thead> <tr> <th>Capacitance</th> <th>Frequency</th> <th>Volt</th> </tr> </thead> <tbody> <tr> <td>C ≤ 1000pF</td> <td>1MHz ± 10%</td> <td rowspan="2">0.5 to 5Vrms</td> </tr> <tr> <td>C > 1000pF</td> <td>1kHz ± 10%</td> </tr> </tbody> </table>	Capacitance	Frequency	Volt	C ≤ 1000pF	1MHz ± 10%	0.5 to 5Vrms	C > 1000pF	1kHz ± 10%	Within tolerance
Capacitance	Frequency		Volt								
C ≤ 1000pF	1MHz ± 10%	0.5 to 5Vrms									
C > 1000pF	1kHz ± 10%										
Q			C ≥ 30pF : Q ≥ 1000 C < 30pF : Q ≥ 400 + 20C								
Insulation Resistance (IR)		Apply the rated voltage for 1 minute, and measure it in normal temperature and humidity. The charge and discharge current of the capacitor must not exceed 50mA.	Over 10000MΩ or 500MΩ·μF, whichever is less								
Dielectric Resistance		Apply *3 times of the rated voltage for 1 to 5 seconds. *CU02CΔR20-120/25V: twice The charge and discharge current of the capacitor must not exceed 50mA.	No problem observed								
Appearance		Microscope	No problem observed								
Termination Strength		Apply a sideward force of 500g (5N) to a PCB-mounted sample. note: 1N for 01005 size.	No problem observed								
Bending Strength		Glass epoxy PCB: Fulcrum spacing: 90mm, duration time 10 seconds.	No significant damage with 1mm bending.								
Vibration Test	Appearance	Vibration frequency: 10 to 55 (Hz) Amplitude: 1.5mm Sweeping condition: 10→55→10Hz/ 1 minute in X, Y and Z directions: 2 hours each, 6 hours in total.	No problem observed								
	Capacitance		Within Tolerance								
	Q		C ≥ 30pF : Q ≥ 1000 C < 30pF : Q ≥ 400 + 20C								
Soldering Heat Resistant	Appearance	Soak the sample in 260°C ± 5°C solder for 10 ± 0.5 seconds and place in normal temperature and humidity, and measure the sample after 24 ± 2 hours. (Pre-heating conditions)	No problem observed								
	Capacitance Variation		Within ± 2.5% or ± 0.25pF, whichever is larger								
	Q		C ≥ 30pF : Q ≥ 1000 C < 30pF : Q ≥ 400 + 20C								
	IR		Over 10000MΩ or 500MΩ·μF whichever is less								
	Withstanding Voltage		The charge and discharge current of the capacitor must not exceed 50mA for IR and withstanding voltage measurement.	Resist without problem							
Solderability		Soaking condition	Solder coverage : 95% min.								
		<table border="1"> <thead> <tr> <th>Order</th> <th>Temperature</th> <th>Time</th> </tr> </thead> <tbody> <tr> <td>1</td> <td>80 to 100°C</td> <td>2 minutes</td> </tr> <tr> <td>2</td> <td>150 to 200°C</td> <td>2 minutes</td> </tr> </tbody> </table>		Order	Temperature	Time	1	80 to 100°C	2 minutes	2	150 to 200°C
Order	Temperature	Time									
1	80 to 100°C	2 minutes									
2	150 to 200°C	2 minutes									
Temperature Cycle	Appearance	(Cycle) Room temperature (3 min.) → Lowest operation temperature (30 min.) → Room temperature (3 min.) → Highest operation temperature (30 min.) After 5 cycles, measure after 24 ± 2 hours. The charge and discharge current of the capacitor must not exceed 50mA for IR and withstanding voltage measurement.	No problem observed								
	Capacitance Variation		Within ± 2.5% or ± 0.25pF, whichever is larger								
	Q		C ≥ 30pF : Q ≥ 1000 C < 30pF : Q ≥ 400 + 20C								
	IR		Over 10000MΩ or 500MΩ·μF, whichever is less								
	Withstanding Voltage		Resist without problem								
Moisture Resistant Load	Appearance	After applying the rated voltage for 500 + 12/-0 hours in the condition of 40°C ± 2°C and 90 to 95%RH, allow the parts to stabilize in normal temperature and humidity for 24 ± 2 hours, before measurement. The charge and discharge current of the capacitor must not exceed 50mA for IR measurement.	No problem observed								
	Capacitance Variation		Within ± 7.5% or ± 0.75pF, whichever is larger								
	Q		C ≥ 30pF : Q ≥ 200 C < 30pF : Q ≥ 100 + 10C / 3								
	IR		Over 500MΩ or 25MΩ·μF, whichever is less								
High-Temperature Load	Appearance	After applying *twice the rated voltage in the temperature of 125 ± 3°C for 1000 + 12/-0 hours, measure the sample after 24 ± 2 hours in normal temperature and humidity. The charge and discharge current of the capacitor must not exceed 50mA for IR measurement. *Applied voltages for respective products are indicated in the chart below.	No problem observed.								
	Capacitance Variation		Within ± 3% or ± 0.3pF, whichever is larger								
	Q		C ≥ 30pF : Q ≥ 350 10pF < C < 30pF : Q ≥ 275 + 5C / 2 C < 10pF : Q ≥ 200 + 10C								
	IR		Over 1000MΩ or 50MΩ·μF, whichever is less								

Please ask for individual specification for the hatched range in previous chart.

Voltage to be applied in the High Temperature Load (Applied voltage is the multiple of the rated voltage)

Applied Voltage	Rated Voltage	Products
× 1.0	16V	CM02CA221
× 1.2	25V	CM02CAR20-120

Test Conditions and Standards

Test Conditions and Specifications for High Dielectric Type (X5R, X7R, X7S) CM /CT Series (Standard Spec.1)

Test Items		Test Conditions (Complies with JIS C5101)	Specifications												
Capacitance Value (C)		Measure after heat treatment	Within tolerance												
Tanδ		<table border="1"> <thead> <tr> <th>Capacitance</th> <th>Frequency</th> <th>Volt</th> </tr> </thead> <tbody> <tr> <td>C ≤ 10μF</td> <td>1kHz±10%</td> <td>1.0±0.2Vrms</td> </tr> <tr> <td></td> <td>*1kHz±10%</td> <td>0.5±0.2Vrms</td> </tr> <tr> <td>C > 10μF</td> <td>120Hz±10%</td> <td>0.5±0.2Vrms</td> </tr> </tbody> </table>	Capacitance	Frequency	Volt	C ≤ 10μF	1kHz±10%	1.0±0.2Vrms		*1kHz±10%	0.5±0.2Vrms	C > 10μF	120Hz±10%	0.5±0.2Vrms	Refer to capacitance chart
	Capacitance	Frequency	Volt												
C ≤ 10μF	1kHz±10%	1.0±0.2Vrms													
	*1kHz±10%	0.5±0.2Vrms													
C > 10μF	120Hz±10%	0.5±0.2Vrms													
		*CM02X5R104□06A# The charge and discharge current of the capacitor must not exceed 50mA.													
Insulation Resistance (IR)		Apply the rated voltage for 1 minute, and measure it in normal temperature and humidity. The charge and discharge current of the capacitor must not exceed 50mA.	Over 10000MΩ or 500MΩ•μF, whichever is less												
Dielectric Resistance		Apply *2.5 times of the rated voltage for 1 to 5 seconds. *CM316X5R225, CM316X7S225/100V: twice The charge and discharge current of the capacitor must not exceed 50mA.	No problem observed												
Appearance		Microscope	No problem observed												
Termination Strength		Apply a sideward force of 500g (5N) to a PCB-mounted sample. note : 2N for 0201 size, and 1N for 01005 size. Exclude CT series with thickness of less than 0.66mm.	No problem observed												
Bending Strength		Glass epoxy PCB: Fulcrum spacing: 90mm, duration time 10 seconds. Exclude CT series with thickness of less than 0.66mm.	No significant damage with 1mm bending												
Vibration Test	Appearance	Take the initial value after heat treatment. Vibration frequency: 10 to 55 (Hz) Amplitude: 1.5mm	No problem observed												
	Capacitance	Sweeping condition: 10→55→10Hz/ 1 minute in X, Y and Z directions: 2 hours each, 6 hours in total, and place in normal temperature and humidity, then measure the sample after heat treatment.	Within tolerance												
	Tanδ		Within tolerance												
Soldering Heat Resistant	Appearance	Take the initial value after heat treatment.	No problem observed												
	Capacitance Variation	Soak the sample in 260°C±5°C solder for 10±0.5 seconds and place in normal temperature and humidity, and measure after heat treatment. (Pre-heating conditions)	Within±7.5%												
	Tanδ	<table border="1"> <thead> <tr> <th>Order</th> <th>Temperature</th> <th>Time</th> </tr> </thead> <tbody> <tr> <td>1</td> <td>80 to 100°C</td> <td>2 minutes</td> </tr> <tr> <td>2</td> <td>150 to 200°C</td> <td>2 minutes</td> </tr> </tbody> </table>	Order	Temperature	Time	1	80 to 100°C	2 minutes	2	150 to 200°C	2 minutes	Within tolerance			
	Order	Temperature	Time												
	1	80 to 100°C	2 minutes												
2	150 to 200°C	2 minutes													
IR		Over 10000MΩ or 500MΩ•μF, whichever is less													
Withstanding Voltage	The charge and discharge current of the capacitor must not exceed 50mA for IR and withstanding voltage measurement.	Resist without problem													
Solderability		Soaking condition <table border="1"> <thead> <tr> <th>Sn-3Ag-0.5Cu</th> <th>245±5°C</th> <th>3±0.5 sec.</th> </tr> <tr> <th>Sn63 Solder</th> <th>235±5°C</th> <th>2±0.5 sec.</th> </tr> </thead> </table>	Sn-3Ag-0.5Cu	245±5°C	3±0.5 sec.	Sn63 Solder	235±5°C	2±0.5 sec.	Solder coverage : 95% min.						
Sn-3Ag-0.5Cu	245±5°C	3±0.5 sec.													
Sn63 Solder	235±5°C	2±0.5 sec.													
Temperature Cycle	Appearance	Take the initial value after heat treatment. (Cycle)	No problem observed												
	Capacitance Variation	Room temperature (3 min.)→ Lowest operation temperature (30 min.)→ Room temperature (3 min.)→ Highest operation temperature(30 min.)	Within±7.5%												
	Tanδ	After 5 cycles, measure after heat treatment.	Within tolerance												
	IR	The charge and discharge current of the capacitor must not exceed 50mA for IR and withstanding voltage measurement.	Over 10000MΩ or 500MΩ•μF, whichever is less												
	Withstanding Voltage		Resist without problem												
Moisture Resistant Load	Appearance	Take the initial value after heat treatment.	No problem observed												
	Capacitance Variation	After applying rated voltage for 500+12/-0 hours in the condition of 40°C±2°C and 90 to 95%RH, and place in normal temperature and humidity, then measure the sample after heat treatment.	Within±12.5%												
	Tanδ	The charge and discharge current of the capacitor must not exceed 50mA for IR measurement.	200% max. of initial value												
	IR		Over 500MΩ or 25MΩ•μF, whichever is less												
High-Temperature Load	Appearance	Take the initial value after heat treatment.	No problem observed												
	Capacitance Variation	After applying *twice the rated voltage at the highest operation temperature for 1000+12/-0 hours, and measure the sample after heat treatment in normal temperature and humidity. The charge and discharge current of the capacitor must not exceed 50mA for IR measurement.	Within±12.5%												
	Tanδ	*Apply 1.5 times when the rated voltage is 10V or less. Applied voltages for respective products are indicated in the chart below.	200% max. of initial value												
	IR		Over 1000MΩ or 50MΩ•μF, whichever is less												
Heat treatment		Expose sample in the temperature of 150+0/-10°C for 1 hour and leave the sample in normal temperature and humidity for 24±2 hours.													

Voltage to be applied in the High Temperature Load (Applied voltage is the multiple of the rated voltage)

Applied Voltage	Rated Voltage	Products
×1.0	10V	CM02X5R104
	100V	CM316X5R225, CM316X7S225
×1.3	6.3V	CM02X5R153-104, CT03X5R104
×1.5	16V	CM02X5R101-103, CM05X5R224, CM105X5R225, CM21X5R106, CM316X5R226, CM02X7R101-222, CM316X7R106, CM32X7R226, CT105X5R105, CT21X5R475
	25V	CM21X5R225, CM316X5R106, CM32X5R106-226, CM05X7R104, CM21X7R225, CM32X7R106
	50V	CM21X5R105, CM316X5R475, CM32X5R106, CM21X7R105, CM32X7R106, CT21X5R225,

Please contact us for the optional specifications of the capacitance chart.

Test Conditions and Standards

Test Conditions and Specifications for High Dielectric Type (X5R, X6S, X7R, X7S, X7T) CM /CT Series (Standard Spec.2)

Test Items	Test Conditions (Complies with JIS C5101)	Specifications												
Capacitance Value (C)	Measure after heat treatment	Within tolerance												
Tanδ	<table border="1"> <thead> <tr> <th>Capacitance</th> <th>Frequency</th> <th>Volt</th> </tr> </thead> <tbody> <tr> <td>C ≤ 10μF</td> <td>1kHz±10%</td> <td>1.0±0.2Vrms</td> </tr> <tr> <td>C > 10μF</td> <td>*1kHz±10%</td> <td>0.5±0.2Vrms</td> </tr> <tr> <td></td> <td>120Hz±10%</td> <td>0.5±0.2Vrms</td> </tr> </tbody> </table> <p>*CM02X5R474M06A#, CM03X5R225□06A#, CM03X5R225M06A#035, CM03X5R475M06A#055, CM03X5R475M04A#, CM05X5R106M06A#, CT05X5R475M06A#033 The charge and discharge current of the capacitor must not exceed 50mA.</p>	Capacitance	Frequency	Volt	C ≤ 10μF	1kHz±10%	1.0±0.2Vrms	C > 10μF	*1kHz±10%	0.5±0.2Vrms		120Hz±10%	0.5±0.2Vrms	Refer to capacitance chart
	Capacitance	Frequency	Volt											
C ≤ 10μF	1kHz±10%	1.0±0.2Vrms												
C > 10μF	*1kHz±10%	0.5±0.2Vrms												
	120Hz±10%	0.5±0.2Vrms												
Insulation Resistance (IR)	Apply the rated voltage for 1 minute, and measure it in normal temperature and humidity. The charge and discharge current of the capacitor must not exceed 50mA.	Over 50MΩ•μF												
Dielectric Resistance	Apply *2.5 times of the rated voltage for 1 to 5 seconds. *CM21X7S105, CM316X7S475/100V: twice The charge and discharge current of the capacitor must not exceed 50mA.	No problem observed												
Appearance	Microscope	No problem observed												
Termination Strength	Apply a sideward force of 500g (5N) to a PCB-mounted sample. note : 2N for 0201 size, and 1N for 01005 size. Exclude CT series with thickness of less than 0.66mm.	No problem observed												
Bending Strength	Glass epoxy PCB: Fulcrum spacing: 90mm, duration time 10 seconds. Exclude CT series with thickness of less than 0.66mm.	No significant damage with 1mm bending												
Vibration Test	Appearance	Take the initial value after heat treatment. Vibration frequency: 10 to 55 (Hz) Amplitude: 1.5mm	No problem observed											
	Capacitance	Sweeping condition: 10→55→10Hz/ 1 minute in X, Y and Z directions: 2 hours each, 6 hours in total, and place in normal temperature and humidity, then measure the sample after heat treatment.	Within tolerance											
	Tanδ		Within tolerance											
Soldering Heat Resistant	Appearance	Take the initial value after heat treatment. Soak the sample in 260°C±5°C solder for 10±0.5 seconds and place in normal temperature and humidity, and measure after heat treatment. (Pre-heating conditions)	No problem observed											
	Capacitance Variation		Within±7.5%											
	Tanδ		Within tolerance											
	IR		Over 50MΩ•μF											
	Withstanding Voltage	The charge and discharge current of the capacitor must not exceed 50mA for IR and withstanding voltage measurement.	Resist without problem											
Solderability	Soaking condition	<table border="1"> <thead> <tr> <th>Order</th> <th>Temperature</th> <th>Time</th> </tr> </thead> <tbody> <tr> <td>1</td> <td>80 to 100°C</td> <td>2 minutes</td> </tr> <tr> <td>2</td> <td>150 to 200°C</td> <td>2 minutes</td> </tr> </tbody> </table>	Order	Temperature	Time	1	80 to 100°C	2 minutes	2	150 to 200°C	2 minutes			
		Order	Temperature	Time										
1	80 to 100°C	2 minutes												
2	150 to 200°C	2 minutes												
	<table border="1"> <tbody> <tr> <td>Sn-3Ag-0.5Cu</td> <td>245±5°C</td> <td>3±0.5 sec.</td> </tr> <tr> <td>Sn63 Solder</td> <td>235±5°C</td> <td>2±0.5 sec.</td> </tr> </tbody> </table>	Sn-3Ag-0.5Cu	245±5°C	3±0.5 sec.	Sn63 Solder	235±5°C	2±0.5 sec.	Solder coverage : 95% min.						
Sn-3Ag-0.5Cu	245±5°C	3±0.5 sec.												
Sn63 Solder	235±5°C	2±0.5 sec.												
Temperature Cycle	Appearance	Take the initial value after heat treatment. (Cycle)	No problem observed											
	Capacitance Variation	Room temperature (3 min.)→Lowest operation temperature (30 min.)→Room temperature (3 min.)→Highest operation temperature(30 min.)	Within±7.5%											
	Tanδ	After 5 cycles, measure after heat treatment.	Within tolerance											
	IR	The charge and discharge current of the capacitor must not exceed 50mA for IR and withstanding voltage measurement.	Over 50MΩ•μF											
	Withstanding Voltage		Resist without problem											
Moisture Resistant Load	Appearance	Take the initial value after heat treatment.	No problem observed											
	Capacitance Variation	After applying rated voltage for 500+12/-0 hours in the condition of 40°C±2°C and 90 to 95%RH, and place in normal temperature and humidity, then measure the sample after heat treatment. The charge and discharge current of the capacitor must not exceed 50mA for IR measurement.	Within±12.5%											
	Tanδ		200% max. of initial value											
	IR		Over 10MΩ•μF											
High-Temperature Load	Appearance	Take the initial value after heat treatment.	No problem observed											
	Capacitance Variation	After applying *□ times the rated voltage at the highest operation temperature for 1000+12/-0 hours, and measure the sample after heat treatment in normal temperature and humidity. The charge and discharge current of the capacitor must not exceed 50mA for IR measurement.	Within±12.5%											
	Tanδ	*Apply 1.0 times when the rated voltage is 4V or less. Applied voltages for respective products are indicated in the chart below.	200% max. of initial value											
	IR		Over 10MΩ•μF											
Heat treatment	Expose sample in the temperature of 150+0/-10°C for 1 hour and leave the sample in normal temperature and humidity for 24±2 hours.													

Voltage to be applied in the High Temperature Load (Applied voltage is the multiple of the rated voltage)

Applied Voltage	Rated Voltage	Products	Applied Voltage	Rated Voltage	Products		
×1.0	6.3V	CM02X5R224, CM02X5R474, CM03X5R225, CM03X5R475, CM05X5R106	×1.2	6.3V	CM03X5R105		
		CM05X5R156, CM05X5R226, CM21X5R476, CM03X6S105, CM105X6S226			CM03X5R474		
		CT05X5R105, CT05X5R225, CT05X5R475		×1.3	10V	CM03X5R223-224, CM05X5R105-225	
	CM03X5R225, CM105X5R226, CM21X6S226	16V	CM05X5R105				
	×1.5	16V	CM03X5R105, CM05X5R225, CM05X5R475, CM105X5R226	6.3V	6.3V	CM21X6S226, CM05X7S105	
			CM05X6S225, CM21X6S226, CM21X7R475			CM105X7T106, CM21X7T226	
		25V	CM05X5R105, CM05X5R225, CM05X5R475, CM105X5R475	×1.5	10V	10V	CM03X5R105, CM05X5R474, CM05X5R475,
			CM105X5R106, CM21X5R226, CM05X6S105				CM21X5R226, CM105X6S106, CM105X7T475
			CM05X5R105, CM105X5R475, CM105X5R106				25V
		100V	CM21X7S105, CM316X7S475	50V	CM316X7R475		

Please contact us for the optional specifications of the capacitance chart.



Test Conditions and Standards

Substrate for Adhesion Strength Test, Vibration Test, Soldering Heat Resistance Test, Temperature Cycle Test, Load Humidity Test, High-Temperature with Loading Test.

(Unit: mm)

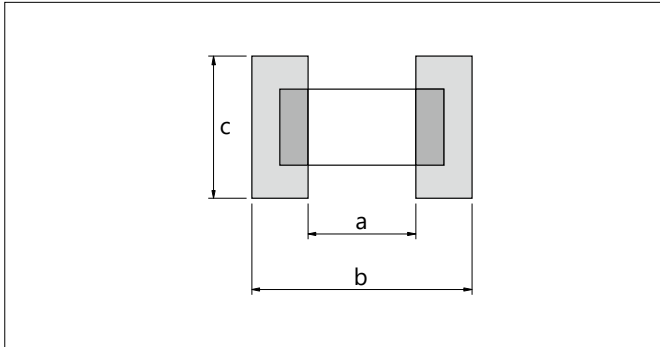

Size (EIA Code)	a	b	c
02 (01005)	0.15	0.5	0.2
03 (0201)	0.26	0.92	0.32
05 (0402)	0.4	1.4	0.5
105 (0603)	1.0	3.0	1.2
21 (0805)	1.2	4.0	1.65
316 (1206)	2.2	5.0	2.0
32 (1210)	2.2	5.0	2.9

Substrate for Bending Test

(Unit: mm)

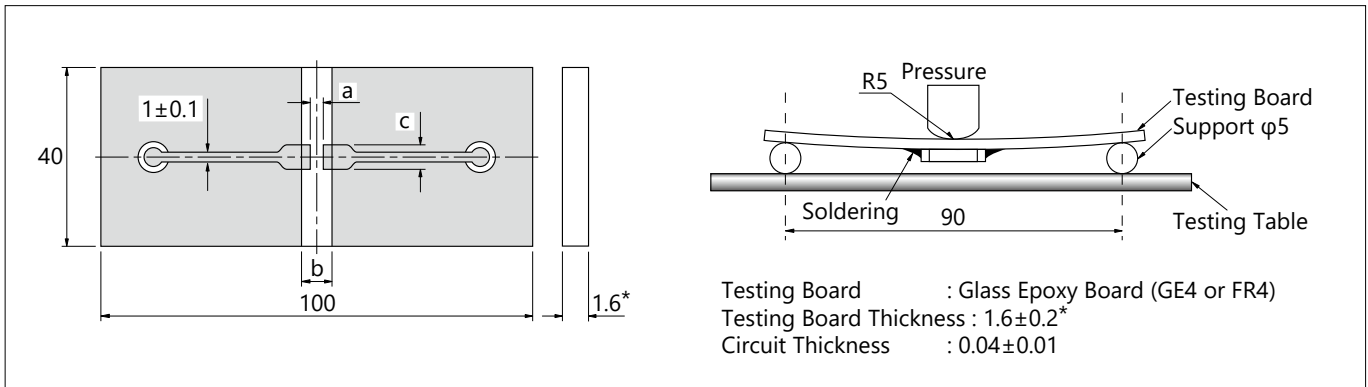

*02, 03, 05 size 0.8±0.1mm

Structure

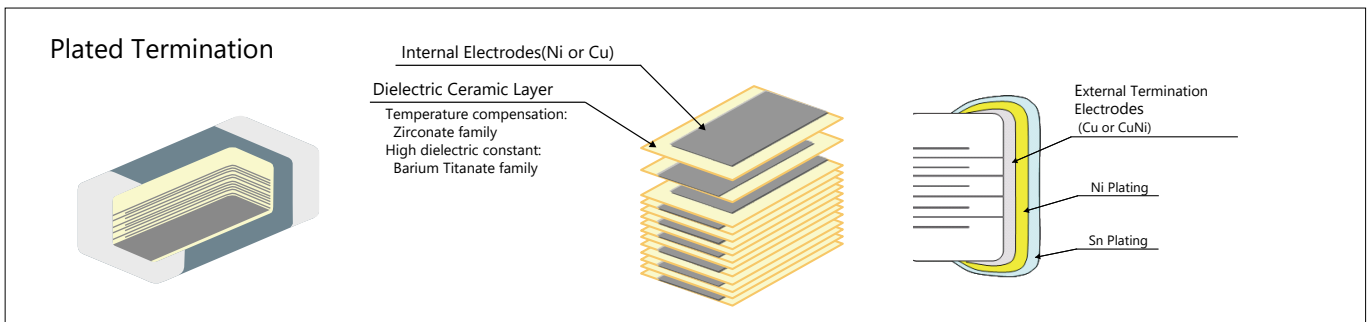

■ Certification status

<ISO>

Acquired ISO 9001 quality management system certification.

<IATF>

Acquired IATF 16949 quality management system certification.

■ Production plant

Kagoshima kokubu plant

Packaging Options Tape and Reel

Reel

(Unit: mm)

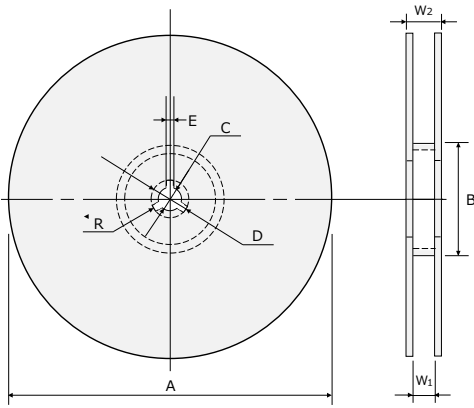

Code Reel	A	B	C	D
7-inch Reel (CODE: T, H, Q)	180 ⁺⁰ _{-2.0}	φ60 min.	13±0.5	21±0.8
7-inch Reel (CODE: P)	178±2.0			
13-inch Reel (CODE: L, N, W)	330±2.0			
Code Reel	E	W ₁	W ₂	R
7-inch Reel (CODE: T, H, Q)	2.0±0.5	10.5±1.5	16.5 max.	1.0
7-inch Reel (CODE: P)		4.35±0.3	6.95±1.0	
13-inch Reel (CODE: L, N, W)		9.5±1.0	16.5 max.	

Carrier Tape

(Unit: mm)

F=1mm (02 Size)

F=2mm (02, 03, 05 Size)

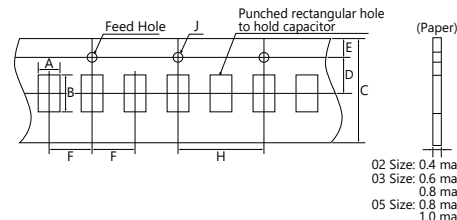
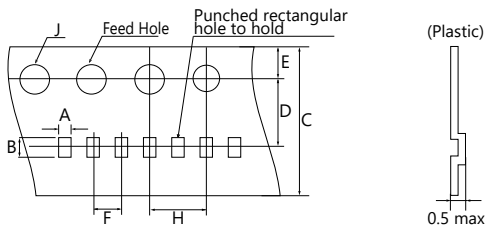

02 Size: 0.4 max.
03 Size: 0.6 max.
05 Size: 0.8 max.
1.0 max.²⁾

¹⁾Applicable to product thickness of 0.5±0.05
²⁾Applicable to product thickness of 0.8max.

F=1mm (03, 05 Size)

F=4mm (105, 21, 316, 32 Size)

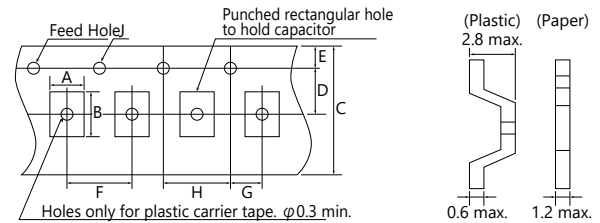
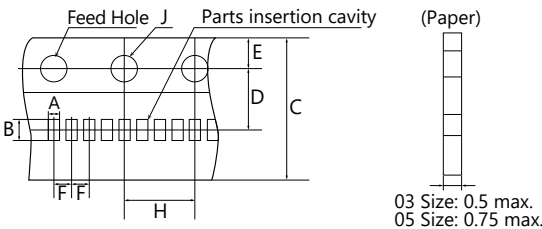

Size (EIA Code)	A	B	C	D	E	F	G	H	J	Carrier Tape	
										Width	Material
02 (01005)*	0.24±0.02	0.44±0.02	4.0±0.08	1.8±0.02	0.9±0.05	1.0±0.02	—	2.0±0.04	0.8±0.04	4	Plastic
	0.25±0.03	0.45±0.03	8.0±0.3	3.5±0.05	1.75±0.1	2.0±0.05	—	4.0±0.1	1.5±0.1/-0	8	Paper
03 (0201)*	0.37±0.03	0.67±0.03	8.0+0.3/-0.1 8.0±0.3	3.5±0.05	1.75±0.1	1.0±0.05 2.0±0.05	—	4.0±0.05 4.0±0.1	1.5±0.1/-0	8	Paper
	0.39±0.03	0.69±0.03	8.0±0.3	3.5±0.05	1.75±0.1	2.0±0.05	—	4.0±0.1	1.5±0.1/-0		
	0.42±0.03	0.72±0.03	8.0±0.3	3.5±0.05	1.75±0.1	2.0±0.05	—	4.0±0.1	1.5±0.1/-0		
	0.44±0.05	0.74±0.05	8.0±0.3	3.5±0.05	1.75±0.1	2.0±0.05	—	4.0±0.1	1.5±0.1/-0		
05 (0402)*	0.65±0.1	1.15±0.1	8.0+0.3/-0.1 8.0±0.3	3.5±0.05	1.75±0.1	1.0±0.05 2.0±0.05	—	4.0±0.05 4.0±0.1	1.5±0.1/-0	8	Paper
	0.75±0.1		2.0±0.05			—	4.0±0.1				
	0.8±0.1	1.3±0.1	8.0±0.3	3.5±0.05	1.75±0.1	2.0±0.05	—	4.0±0.1			
105 (0603)*	1.0±0.2	1.8±0.2	8.0±0.3	3.5±0.05	1.75±0.1	4.0±0.1	2.0±0.05	4.0±0.1	1.5±0.1/-0	8	Paper
	1.1±0.2	1.9±0.2	8.0±0.3	3.5±0.05	1.75±0.1	4.0±0.1	2.0±0.05	4.0±0.1	1.5±0.1/-0		
21 (0805)	1.5±0.2	2.3±0.2	8.0±0.3	3.5±0.05	1.75±0.1	4.0±0.1	2.0±0.05	4.0±0.1	1.5±0.1/-0	8	Paper
										8	Plastic
316 (1206)	2.0±0.2	3.6±0.2	8.0±0.3	3.5±0.05	1.75±0.1	4.0±0.1	2.0±0.05	4.0±0.1	1.5±0.1/-0	8	Paper
										8	Plastic
32 (1210)	2.9±0.2	3.6±0.2	8.0±0.3	3.5±0.05	1.75±0.1	4.0±0.1	2.0±0.05	4.0±0.1	1.5±0.1/-0	8	Plastic

* Option



Packaging Options

Detail of leader and trailer

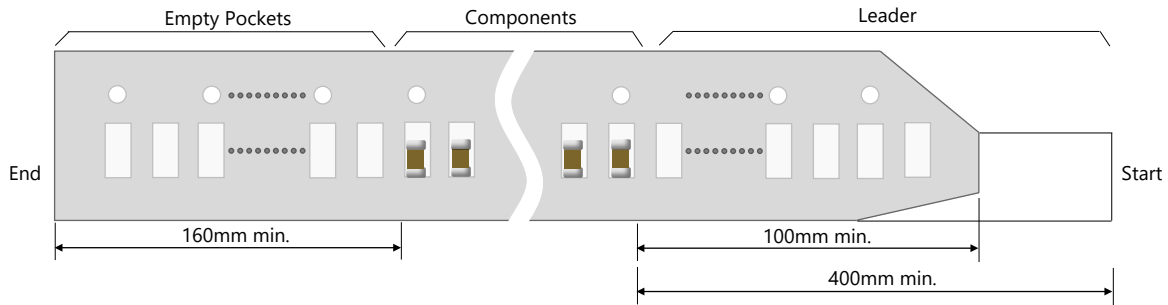

Adhesive tape

- 1) The exfoliative strength when peeling off the top tape from the carrier tape by the method of the following figure shall be *0.1 to 0.7N. *02 Size: 0.1 to 0.5N
- 2) When the top tape is peeled off, the adhesive stays on the top tape.
- 3) Chip capacitors will be in a state free without being stuck on the thermal adhesive tape.

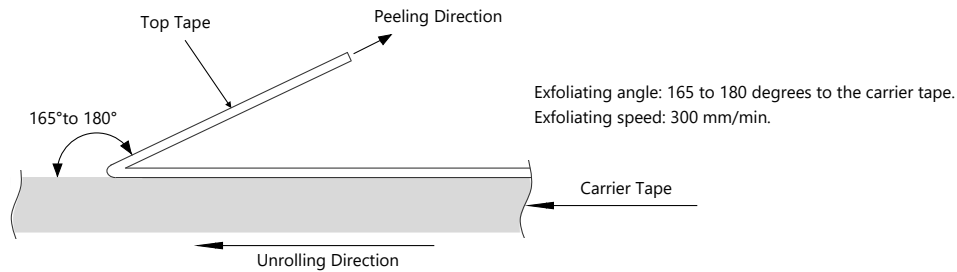

Carrier tape

- 1) Chip will not fall off from carrier tape or carrier tape will not be damaged by bending than within a radius of 25mm.
- 2) The chip are inserted continuously without any empty pocket.
- 3) Chip will not be mis-mounted because of too big clearance between components and cavity. Also the waste of carrier tape will not fill a nozzle hole of mounting machine.

Surface Mounting Information

Dimensions for recommended typical land

Since the amount of solder (size of fillet) to be used has direct influence on the capacitor after mounting, the sufficient consideration is necessary.

When the amounts of solder is too much, the stress that a capacitor receives becomes larger. It may become the cause of a crack in the capacitor. When the land design of printed wiring board is considered, it is necessary to set up the form and size of land pattern so that the amount of solder is suitable.

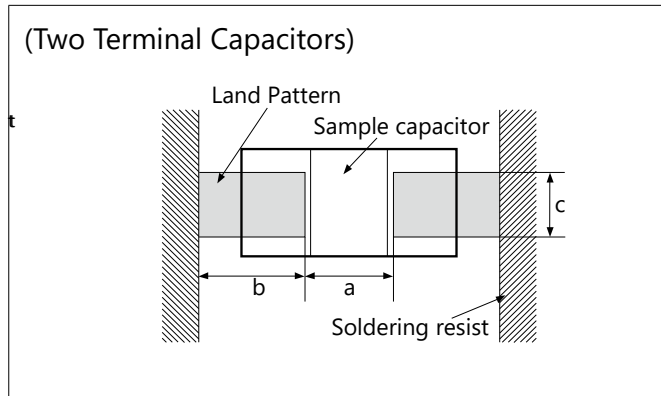

Two Terminal Capacitors

(Unit: mm)

Size (EIA Code)	Dimension		Recommended land dimensions		
	L	W	a	b	c
02 (01005)	0.4±0.02	0.2±0.02	0.13 to 0.2	0.12 to 0.18	0.2 to 0.23
	0.6±0.03	0.3±0.03	0.2 to 0.25	0.25 to 0.35	0.3 to 0.4
03 (0201)	0.6±0.05	0.3±0.05	0.23 to 0.3	0.25 to 0.35	0.3 to 0.45
	0.6±0.09	0.3±0.09	0.23 to 0.3	0.25 to 0.35	0.3 to 0.45
05 (0402)	1.0±0.05	0.5±0.05	0.3 to 0.5	0.35 to 0.45	0.4 to 0.6
	1.0±0.15	0.5±0.15	0.4 to 0.6	0.4 to 0.5	0.5 to 0.75
105 (0603)	1.0±0.2	0.5±0.2	0.7 to 1.0	0.8 to 1.0	0.6 to 0.9
	1.6±0.1	0.8±0.1	0.8 to 1.0	0.8 to 1.0	0.8 to 1.1
	1.6±0.15	0.8±0.15	0.8 to 1.0	0.8 to 1.0	0.8 to 1.1
21 (0805)	1.6±0.2	0.8±0.2	1.0 to 1.3	1.0 to 1.2	1.0 to 1.45
	1.6±0.25	0.8±0.25	1.0 to 1.3	1.0 to 1.2	1.0 to 1.45
	2.0±0.1	1.25±0.1	1.0 to 1.3	1.0 to 1.2	1.25 to 1.55
316 (1206)	2.0±0.15	1.25±0.15	2.1 to 2.5	1.1 to 1.3	1.4 to 1.9
	2.0±0.2	1.25±0.2	2.1 to 2.5	1.1 to 1.3	1.4 to 1.9
	3.2±0.2	1.6±0.15	2.1 to 2.5	1.1 to 1.3	1.6 to 2.0
32 (1210)	3.2±0.2	1.6±0.2	2.1 to 2.5	1.1 to 1.3	1.6 to 2.0
	3.2±0.3	1.6±0.3	2.1 to 2.5	1.1 to 1.3	1.6 to 2.0
	3.2±0.3	1.6±0.3	2.1 to 2.5	1.1 to 1.3	1.9 to 2.8

* Recommended land dimensions may differ depending on dimensional tolerance.

Design of printed circuit and Soldering

The recommended fillet height shall be 1/2 of the thickness of capacitors or 0.5mm. When mounting two or more capacitors in the common land, it is necessary to separate the land with the solder resist strike so that it may become the exclusive land of each capacitor.

Ideal Solder Height

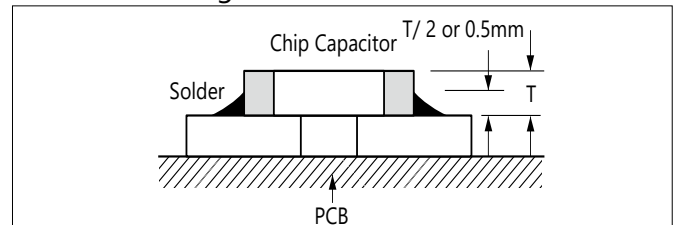

Item	Prohibited	Recommended example : Separation by solder resist
Multiple parts mount		
Mount with leaded parts		
Wire soldering after mounting		
Side by side layout		



Surface Mounting Information

Mounting Design

The chip could crack if the PCB warps during processing after the chip has been soldered.

Recommended chip position on PCB to minimize stress from PCB warpage

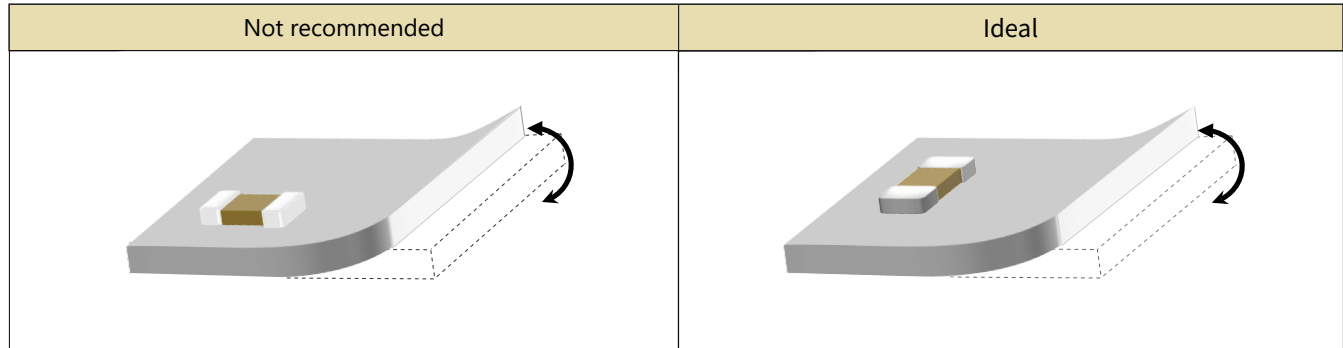

Actual Mounting

- 1) If the position of the vacuum nozzle is too low, a large force may be applied to the chip capacitor during mounting, resulting in cracking.
- 2) During mounting, set the nozzle pressure to a static load of 1 to 3 N.
- 3) To minimize the shock of the vacuum nozzle, provide a support pin on the back of the PCB to minimize PCB flexure.
- 4) Bottom position of pick up nozzle should be adjusted to the top surface of a substrate which camber is corrected.

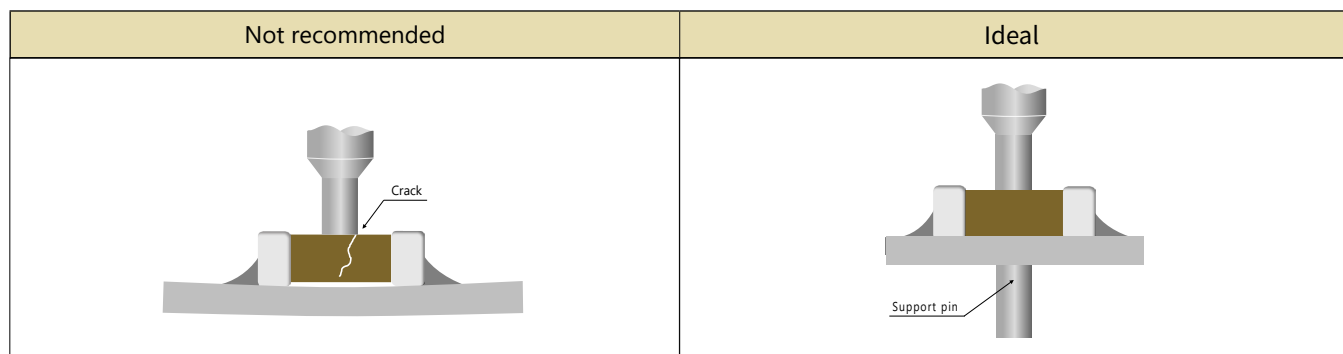

Resin Mold

- 1) If a large amount of resin is used for molding the chip, cracks may occur due to contraction stress during curing. To avoid such cracks, use a low shrinkage resin.
- 2) The insulation resistance of the chip will degrade due to moisture absorption. Use a low moisture absorption resin.
- 3) Check carefully that the resin does not generate a decomposition gas or reaction gas during the curing process or during normal storage. Such gases may crack the chip capacitor or damage the device itself.

Surface Mounting Information

Soldering Method

- 1) Ceramic is easily damaged by rapid heating or cooling. If some heat shock is unavoidable, preheat enough to limit the temperature difference (ΔT) to within 150 degree Celsius.
- 2) The product size 1.6×0.8mm to 3.2×1.6mm can be used in reflow and wave soldering, and the product size of bigger than 3.2×1.6mm, or smaller than 1.6×0.8mm can be used in reflow.
Circuit shortage and smoking can be created by using capacitors which are used neglecting the above caution.
- 3) Please see our recommended soldering conditions.
- 4) In case of using Sn-Zn Solder, please contact us in advance.
- 5) The following condition is recommended for spot heater application.

Recommended spot heater condition

Item	Condition
Distance	5mm min.
Angle	45°
Projection Temp.	400°C max.
Flow rate	Set at the minimum
Nozzle diameter	2φ to 4φ (Single hole type)
Application time	10 sec. max. (1206 and smaller) 30 sec. max. (1210 and larger)

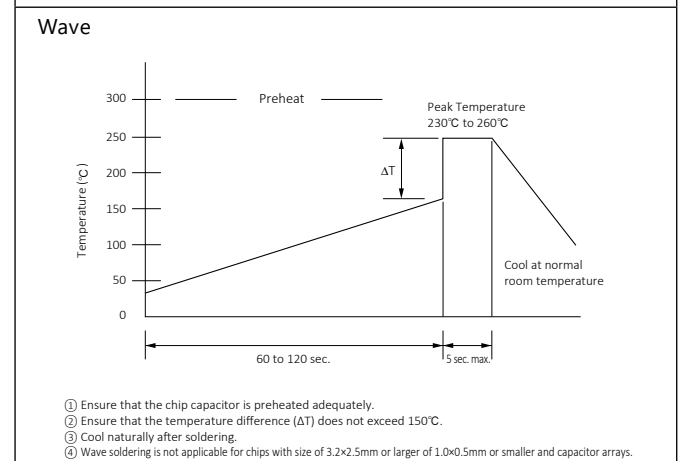
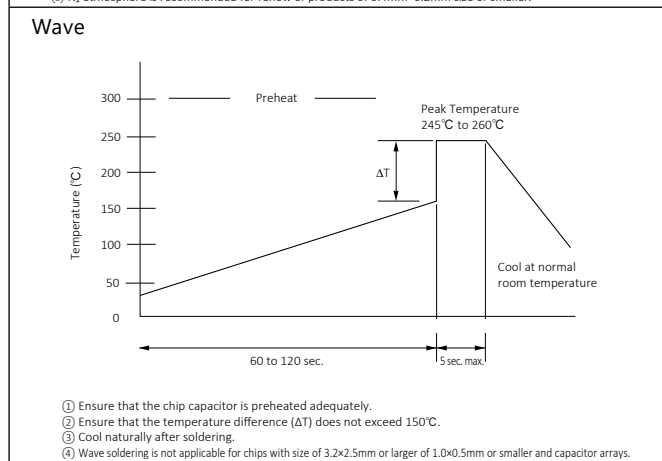
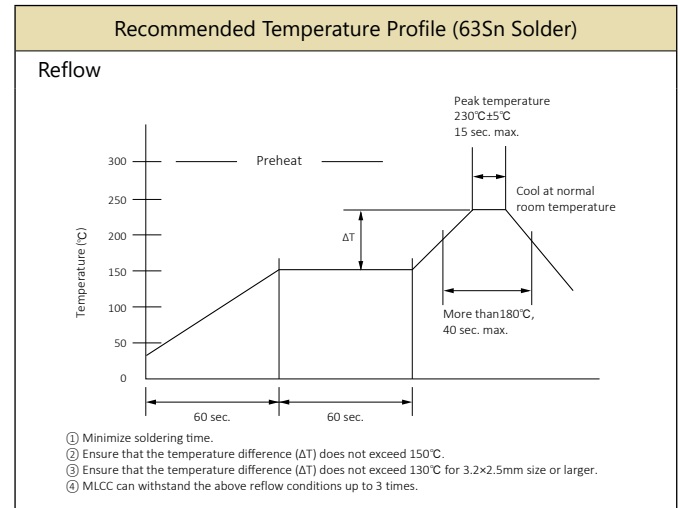
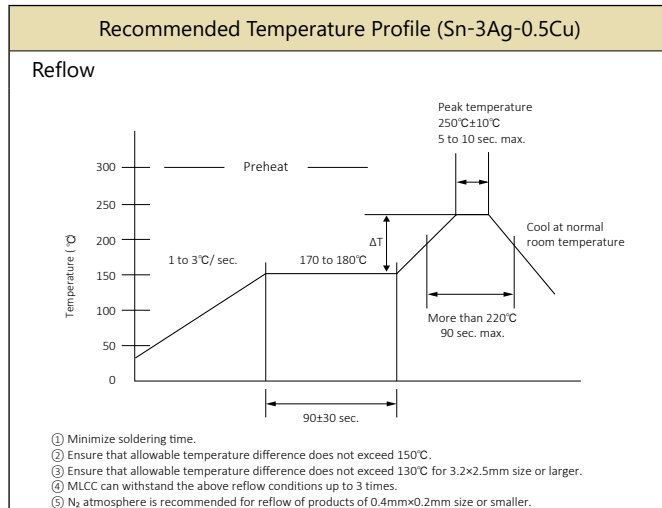
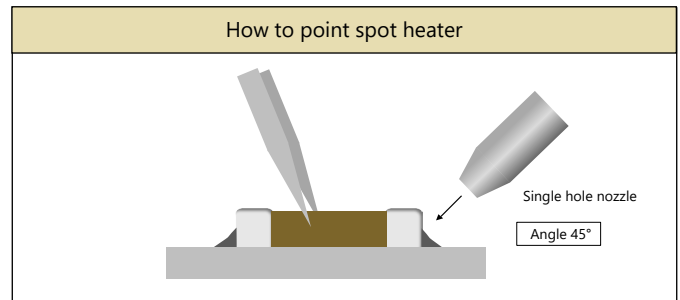



Precautions

Circuit Design

1. Once application and assembly environments have been checked, the capacitor may be used in conformance with the rating and performance which are provided in both the catalog and the specifications. Use exceeding that which is specified may result in inferior performance or cause a short, open, smoking, or flaming to occur, etc.
2. Please consult the manufacturer in advance when the capacitor is used in devices such as: devices which deal with human life, i.e. medical devices; devices which are highly public orientated; and devices which demand a high standard of liability.
Accident or malfunction of devices such as medical devices, space equipment and devices having to do with atomic power could generate grave consequence with respect to human lives or, possibly, a portion of the public. Capacitors used in these devices may require high reliability design different from that of general purpose capacitors.
3. Please use the capacitors in conformance with the operating temperature provided in both the catalog and the specifications.
Be especially cautious not to exceed the maximum temperature. In the situation the maximum temperature set forth in both the catalog and specifications is exceeded, the capacitor's insulation resistance may deteriorate, power may suddenly surge and short-circuit may occur.
The capacitor has a loss, and may self-heat due to equivalent series resistance when alternating electric current is passed therethrough. As this effect becomes especially pronounced in high frequency circuits, please exercise caution.
When using the capacitor in a (self-heating) circuit, please make sure the surface of the capacitor remains under the maximum temperature for usage. Also, please make certain temperature rises remain below 20°C.
4. Please keep voltage under the rated voltage which is applied to the capacitor. Also, please make certain the peak voltage remains below the rated voltage when AC voltage is super-imposed to the DC voltage.
In the situation where AC or pulse voltage is employed, ensure average peak voltage does not exceed the rated voltage.
Exceeding the rated voltage provided in both catalog and specifications may lead to defective withstanding voltage or, in worst case situations, may cause the capacitor to smoke or flame.
5. When the capacitor is to be employed in a circuit in which there is continuous application of a high frequency voltage or a steep pulse voltage, even though it is within the rated voltage, please inquire to the manufacturer. In the situation the capacitor is to be employed using a high frequency AC voltage or a extremely fast rising pulse voltage, even though it is within the rated voltage, it is possible capacitor reliability will deteriorate.
6. It is a common phenomenon of high-dielectric products to have a deteriorated amount of static electricity due to the application of DC voltage.
Due caution is necessary as the degree of deterioration varies depending on the quality of capacitor materials, capacity, as well as the load voltage at the time of operation.
7. Do not use the capacitor in an environment where it might easily exceed the respective provisions concerning shock and vibration specified in the catalog and specifications.
In addition, it is a common piezo phenomenon of high dielectric products to have some voltage due to vibration or to have noise due to voltage change. Please contact sales in such case.
8. If the electrostatic capacity value of the delivered capacitor is within the specified tolerance, please consider this when designing the respective product in order that the assembled product function appropriately.
9. Please contact us upon using conductive adhesives.

Storage

Please note the following regarding the storage of delivered products.

1. Set the storage temperature to + 5 to + 40 °C and humidity to 20 ~ 70% RH. Other meteorological conditions are in accordance with classification 1 K2 of JIS C 60721 -3 -1.
2. Store in a place where corrosive gas (H₂S, SO₂, NO₂, Cl₂, etc.) does not exist in the atmosphere. Also, avoid exposure to salty moisture. In either case, this may cause oxidation corrosion of the terminal electrode, reducing solderability.

If you store the above delivered products according to the conditions listed above, it will satisfy the solderability standard for 6 months from the shipping date.

Safety application guideline and detailed information of electrical properties are also provided in kyocera web site; URL: <https://ele.kyocera.com/en/product/capacitor/>

Multilayer Ceramic Chip Capacitors



Part Number List

General CM02 Series Size (JIS Code) : 01005(0402) # Packaging Code (Packaging quantity) : H(20,000pcs.) / N(80,000pcs.) / P(40,000pcs.)

Dielectric code CA	Capacitance	□:Tolerance	Voltage [V]	Part Number	Q	Dimension			# Packaging Code (quantity)		
						L[mm]	W[mm]	T[mm]			
CG/CH	1pF	B:±0.1pF / C:±0.25pF	25	CM02CA1R0□25A#	420	0.4±0.02	0.2±0.02	0.2±0.02	H / N / P		
	1.5pF			CM02CA1R5□25A#	430	0.4±0.02	0.2±0.02	0.2±0.02	H / N / P		
	2pF			CM02CA2R0□25A#	440	0.4±0.02	0.2±0.02	0.2±0.02	H / N / P		
	3pF			CM02CA3R0□25A#	460	0.4±0.02	0.2±0.02	0.2±0.02	H / N / P		
	4pF			CM02CA4R0□25A#	480	0.4±0.02	0.2±0.02	0.2±0.02	H / N / P		
	5pF			CM02CA5R0□25A#	500	0.4±0.02	0.2±0.02	0.2±0.02	H / N / P		
	6pF	C:±0.25pF / D:±0.5pF	25	CM02CA6R0□25A#	520	0.4±0.02	0.2±0.02	0.2±0.02	H / N / P		
	7pF			CM02CA7R0□25A#	540	0.4±0.02	0.2±0.02	0.2±0.02	H / N / P		
	8pF			CM02CA8R0□25A#	560	0.4±0.02	0.2±0.02	0.2±0.02	H / N / P		
	9pF			CM02CA9R0□25A#	580	0.4±0.02	0.2±0.02	0.2±0.02	H / N / P		
	10pF			J:±5% / K:±10%	25	CM02CA100□25A#	600	0.4±0.02	0.2±0.02	0.2±0.02	H / N / P
	12pF					CM02CA120□25A#	640	0.4±0.02	0.2±0.02	0.2±0.02	H / N / P
	15pF	CM02CA150□25A#	700			0.4±0.02	0.2±0.02	0.2±0.02	H / N / P		
	18pF	CM02CA180□25A#	760			0.4±0.02	0.2±0.02	0.2±0.02	H / N / P		
	22pF	CM02CA220□25A#	840			0.4±0.02	0.2±0.02	0.2±0.02	H / N / P		
	27pF	CM02CA270□16A#	940			0.4±0.02	0.2±0.02	0.2±0.02	H / N / P		
	33pF	CM02CA330□16A#	1000			0.4±0.02	0.2±0.02	0.2±0.02	H / N / P		
	39pF	CM02CA390□16A#	1000			0.4±0.02	0.2±0.02	0.2±0.02	H / N / P		
	47pF	CM02CA470□16A#	1000			0.4±0.02	0.2±0.02	0.2±0.02	H / N / P		
	56pF	CM02CA560□16A#	1000			0.4±0.02	0.2±0.02	0.2±0.02	H / N / P		
	68pF	CM02CA680□16A#	1000	0.4±0.02	0.2±0.02	0.2±0.02	H / N / P				
	82pF	CM02CA820□16A#	1000	0.4±0.02	0.2±0.02	0.2±0.02	H / N / P				
100pF	CM02CA101□16A#	1000	0.4±0.02	0.2±0.02	0.2±0.02	H / N / P					
220pF	CM02CA221□16A#	1000	0.4±0.02	0.2±0.02	0.2±0.02	H / N / P					

General CM02 Series Size (JIS Code) : 01005(0402) # Packaging Code (Packaging quantity) : H(20,000pcs.) / N(80,000pcs.) / P(40,000pcs.)

Dielectric code	Capacitance	□:Tolerance	Voltage [V]	Part Number	Tanδ [%]	Dimension			# Packaging Code (quantity)
						L[mm]	W[mm]	T[mm]	
X5R	100pF	K:±10% / M:±20%	16	CM02X5R101□16A#	12.5	0.4±0.02	0.2±0.02	0.2±0.02	H / N / P
	150pF			CM02X5R151□16A#	12.5	0.4±0.02	0.2±0.02	0.2±0.02	H / N / P
	220pF			CM02X5R221□16A#	12.5	0.4±0.02	0.2±0.02	0.2±0.02	H / N / P
	330pF			CM02X5R331□16A#	12.5	0.4±0.02	0.2±0.02	0.2±0.02	H / N / P
	470pF			CM02X5R471□16A#	12.5	0.4±0.02	0.2±0.02	0.2±0.02	H / N / P
	680pF			CM02X5R681□16A#	12.5	0.4±0.02	0.2±0.02	0.2±0.02	H / N / P
	1000pF			CM02X5R102□16A#	12.5	0.4±0.02	0.2±0.02	0.2±0.02	H / N / P
	1500pF			CM02X5R152□16A#	12.5	0.4±0.02	0.2±0.02	0.2±0.02	H / N / P
	2200pF			CM02X5R222□16A#	12.5	0.4±0.02	0.2±0.02	0.2±0.02	H / N / P
	3300pF			CM02X5R332□16A#	12.5	0.4±0.02	0.2±0.02	0.2±0.02	H / N / P
	4700pF	CM02X5R472□16A#	12.5	0.4±0.02	0.2±0.02	0.2±0.02	H / N / P		
	6800pF	CM02X5R682□16A#	12.5	0.4±0.02	0.2±0.02	0.2±0.02	H / N / P		
	10000pF	CM02X5R103□16A#	12.5	0.4±0.02	0.2±0.02	0.2±0.02	H / N / P		
	15000pF	CM02X5R153□06A#	12.5	0.4±0.02	0.2±0.02	0.2±0.02	H / N / P		
	22000pF	CM02X5R223□06A#	12.5	0.4±0.02	0.2±0.02	0.2±0.02	H / N / P		
	33000pF	CM02X5R333□06A#	12.5	0.4±0.02	0.2±0.02	0.2±0.02	H / N / P		
	47000pF	CM02X5R473□06A#	12.5	0.4±0.02	0.2±0.02	0.2±0.02	H / N / P		
	68000pF	CM02X5R683□06A#	12.5	0.4±0.02	0.2±0.02	0.2±0.02	H / N / P		
	0.1μF	K:±10% / M:±20%	6.3	CM02X5R104□10A#	12.5	0.4±0.02	0.2±0.02	0.2±0.02	H / N / P
	0.22μF			CM02X5R104□06A#	12.5	0.4±0.02	0.2±0.02	0.2±0.02	H / N / P
0.47μF	M:±20%	6.3	CM02X5R224□06A#	12.5	0.4±0.02	0.2±0.02	0.2±0.02	H / N / P	
100pF			CM02X5R474M06A#	12.5	0.4±0.02	0.2±0.02	0.2±0.02	H / N / P	
X7R	100pF	K:±10% / M:±20%	16	CM02X7R101□16A#	12.5	0.4±0.02	0.2±0.02	0.2±0.02	H / N / P
	150pF			CM02X7R151□16A#	12.5	0.4±0.02	0.2±0.02	0.2±0.02	H / N / P
	220pF			CM02X7R221□16A#	12.5	0.4±0.02	0.2±0.02	0.2±0.02	H / N / P
	330pF			CM02X7R331□16A#	12.5	0.4±0.02	0.2±0.02	0.2±0.02	H / N / P
	470pF			CM02X7R471□16A#	12.5	0.4±0.02	0.2±0.02	0.2±0.02	H / N / P
	680pF			CM02X7R681□16A#	12.5	0.4±0.02	0.2±0.02	0.2±0.02	H / N / P
	1000pF			CM02X7R102□16A#	12.5	0.4±0.02	0.2±0.02	0.2±0.02	H / N / P
	1500pF			CM02X7R152□16A#	12.5	0.4±0.02	0.2±0.02	0.2±0.02	H / N / P
	2200pF			CM02X7R222□16A#	12.5	0.4±0.02	0.2±0.02	0.2±0.02	H / N / P

General CM03 Series Size (JIS Code) : 0201(0603) # Packaging Code (Packaging quantity) : H(15,000pcs.)*10,000pcs.) / N(50,000pcs.) / Q(30,000pcs.) / W(150,000pcs.)

Dielectric code	Capacitance	□:Tolerance	Voltage [V]	Part Number	Tanδ [%]	Dimension			# Packaging Code (quantity)	
						L[mm]	W[mm]	T[mm]		
X5R	22000pF	K:±10% / M:±20%	10	CM03X5R223□10A#	10.0	0.6±0.03	0.3±0.03	0.3±0.03	H / N / Q / W	
	33000pF			CM03X5R333□10A#	10.0	0.6±0.03	0.3±0.03	0.3±0.03	H / N / Q / W	
	47000pF			CM03X5R473□10A#	10.0	0.6±0.03	0.3±0.03	0.3±0.03	H / N / Q / W	
	68000pF			CM03X5R683□10A#	10.0	0.6±0.03	0.3±0.03	0.3±0.03	H / N / Q / W	
	0.1μF			CM03X5R104□10A#	10.0	0.6±0.03	0.3±0.03	0.3±0.03	H / N / Q / W	
	0.22μF			CM03X5R224□25A#	12.5	0.6±0.09	0.3±0.09	0.3±0.09	H / N	
	1μF	M:±20%	16	CM03X5R224□16A#	12.5	0.6±0.09	0.3±0.09	0.3±0.09	H / N	
			10	CM03X5R224□10A#	10.0	0.6±0.03	0.3±0.03	0.3±0.03	H / N / Q / W	
			6.3	CM03X5R474□06A#	12.5	0.6±0.03	0.3±0.03	0.3±0.03	H / N / Q / W	
			16	CM03X5R105M16A#	20.0	0.6±0.09	0.3±0.09	0.3±0.09	H / N	
			10	CM03X5R105M10A#	20.0	0.6±0.09	0.3±0.09	0.3±0.09	H / N	
			10	CM03X5R105M10A#035	12.5	0.6±0.05	0.3±0.05	0.3±0.05	H / N / Q / W	
	2.2μF	K:±10% / M:±20%	6.3	CM03X5R105□06A#	12.5	0.6±0.05	0.3±0.05	0.3±0.05	H / N / Q / W	
				10	CM03X5R225M10A#	15.0	0.6±0.09	0.3±0.09	0.3±0.09	H / N
				6.3	CM03X5R225□06A#	12.5	0.6±0.09	0.3±0.09	0.3±0.09	H / N
				6.3	CM03X5R225M06A#035	12.5	0.6±0.05	0.3±0.05	0.3±0.05	H / N / Q / W
				4	CM03X5R475M04A#	12.5	0.6±0.09	0.3±0.09	0.5±0.05	H(*)
				4	CM03X5R475M04A#055	12.5	0.6±0.09	0.3±0.09	0.3±0.09	H / N
X6S	1μF	M:±20%	10	CM03X6S105M10A#	20.0	0.6±0.09	0.3±0.09	0.3±0.09	H / N	
			6.3	CM03X6S105M06A#039	20.0	0.6±0.09	0.3±0.09	0.3±0.09	H / N	
			4	CM03X6S105M04A#039	20.0	0.6±0.09	0.3±0.09	0.3±0.09	H / N	
			2.5	CM03X6S475M02A#055	15.0	0.6±0.09	0.3±0.09	0.5±0.05	H(*)	
X6T	0.22μF	K:±10% / M:±20%	10	CM03X6T224□10A#	12.5	0.6±0.09	0.3±0.09	0.3±0.09	H / N	
			2.5	CM03X6T105M02A#035	12.5	0.6±0.05	0.3±0.05	0.3±0.05	H / N / Q / W	
			4	CM03X6T225M04A#	12.5	0.6±0.09	0.3±0.09	0.3±0.09	H / N	
X7S	0.1μF	K:±10% / M:±20%	2.5	CM03X6T225M02A#	12.5	0.6±0.09	0.3±0.09	0.3±0.09	H / N	
			6.3	CM03X7S104□06A#	10.0	0.6±0.03	0.3±0.03	0.3±0.03	H / N / Q / W	
X7T	1μF	M:±20%	6.3	CM03X7T105M06A#	12.5	0.6±0.09	0.3±0.09	0.3±0.09	H / N	

Multilayer Ceramic Chip Capacitors



Part Number List

General CM05 Series Size (JIS Code) : 0402(1005) # Packaging Code (Packaging quantity) : H(10,000pcs) / N(50,000pcs)/(**40,000pcs)/(**30,000pcs)/ Q(20,000pcs) / W(100,000pcs)

Dielectric code	Capacitance	□:Tolerance	Voltage [V]	Part Number	Tanδ [%]	Dimension			# Packaging Code (quantity)			
						L[mm]	W[mm]	T[mm]				
X5R	0.1μF	K:±10% / M:±20%	25	CM05X5R104□25A#	5.0	1.0±0.05	0.5±0.05	0.5±0.05	H / N / Q / W			
			16	CM05X5R224□16A#	12.5	1.0±0.05	0.5±0.05	0.5±0.05	H / N / Q / W			
			10	CM05X5R474□10A#	12.5	1.0±0.05	0.5±0.05	0.5±0.05	H / N / Q / W			
	35		CM05X5R105□35A#	10.0	1.0±0.05	0.5±0.05	0.5±0.05	H / N / Q / W				
	25		CM05X5R105□25A#	10.0	1.0±0.05	0.5±0.05	0.5±0.05	H / N / Q / W				
	16		CM05X5R105□16A#	10.0	1.0±0.05	0.5±0.05	0.5±0.05	H / N / Q / W				
	10		CM05X5R105□10A#	10.0	1.0±0.05	0.5±0.05	0.5±0.05	H / N / Q / W				
	35		CM05X5R225M35A#	12.5	1.0±0.2	0.5±0.2	0.5±0.2	H / N(*)				
	25		CM05X5R225M25A#	12.5	1.0±0.2	0.5±0.2	0.5±0.2	H / N(*)				
	16		CM05X5R225□25A#055	12.5	1.0±0.2	0.5±0.2	0.55 max.	H / N				
	2.2μF	K:±10% / M:±20%	16	CM05X5R225□16A#	12.5	1.0±0.05	0.5±0.05	0.5±0.05	H / N / Q / W			
			10	CM05X5R225□10A#	12.5	1.0±0.05	0.5±0.05	0.5±0.05	H / N / Q / W			
			25	CM05X5R475M25A#	12.5	1.0±0.2	0.5±0.2	0.5±0.2	H / N(*)			
			16	CM05X5R475M16A#	12.5	1.0±0.2	0.5±0.2	0.5±0.2	H / N(*)			
	4.7μF		M:±20%	10	CM05X5R475M10A#	12.5	1.0±0.2	0.5±0.2	0.5±0.2	H / N(*)		
				10	CM05X5R475M10A#065	12.5	1.0±0.15	0.5±0.15	0.5±0.15	H / N(*)		
				10	CM05X5R106M10A#	12.5	1.0±0.2	0.5±0.2	0.5±0.2	H / N(*)		
	6.3			CM05X5R106M06A#	12.5	1.0±0.2	0.5±0.2	0.5±0.2	H / N(*)			
	10μF			M:±20%	6.3	CM05X5R156M06A#	12.5	1.0±0.15	0.5±0.15	0.5±0.15	H / N(*)	
					4	CM05X5R156M04A#	12.5	1.0±0.15	0.5±0.15	0.5±0.15	H / N(*)	
15μF	M:±20%	6.3			CM05X5R226M06A#	12.5	1.0±0.2	0.5±0.2	0.5±0.2	H / N(*)		
		6.3			CM05X5R226M06A#080	12.5	1.0±0.2	0.5±0.2	0.8 max.	H / N(**)		
4		CM05X5R226M04A#			12.5	1.0±0.2	0.5±0.2	0.5±0.2	H / N(*)			
0.47μF		M:±20%			16	CM05X6S474M16A#	12.5	1.0±0.05	0.5±0.05	0.5±0.05	H / N / Q / W	
			10		CM05X6S474M10A#	12.5	1.0±0.05	0.5±0.05	0.5±0.05	H / N / Q / W		
25			CM05X6S105□25A#		12.5	1.0±0.05	0.5±0.05	0.5±0.05	H / N / Q / W			
1μF			K:±10% / M:±20%		10	CM05X6S105M10A#	12.5	1.0±0.05	0.5±0.05	0.5±0.05	H / N / Q / W	
					16	CM05X6S225M16A#055	12.5	1.0±0.2	0.5±0.2	0.55 max.	H / N	
10				CM05X6S475M10A#	12.5	1.0±0.2	0.5±0.2	0.5±0.2	H / N(*)			
4.7μF				M:±20%	6.3	CM05X6S475M06A#	12.5	1.0±0.2	0.5±0.2	0.5±0.2	H / N(*)	
	6.3				CM05X6S475M06A#065	12.5	1.0±0.15	0.5±0.15	0.5±0.15	H / N(*)		
10	CM05X6S106M06A#				12.5	1.0±0.2	0.5±0.2	0.5±0.2	H / N(*)			
10μF	M:±20%				4	CM05X6S226M04A#080	12.5	1.0±0.2	0.5±0.2	0.8 max.	H / N(**)	
		4			CM05X6S226M04A#	12.5	1.0±0.2	0.5±0.2	0.5±0.2	H / N(*)		
0.47μF		M:±20%			16	CM05X7R104□25A#	12.5	1.0±0.05	0.5±0.05	0.5±0.05	H / N / Q / W	
					6.3	CM05X7R474□06A#	12.5	1.0±0.05	0.5±0.05	0.5±0.05	H / N / Q / W	
1μF			K:±10% / M:±20%		6.3	CM05X7S105□06A#	12.5	1.0±0.05	0.5±0.05	0.5±0.05	H / N / Q / W	
					4	CM05X7S105□04A#	12.5	1.0±0.05	0.5±0.05	0.5±0.05	H / N / Q / W	
2.2μF					K:±10% / M:±20%	10	CM05X7S225□10A#065	5.0	1.0±0.15	0.5±0.15	0.5±0.15	H / N(*)
				6.3		CM05X7S225□06A#065	5.0	1.0±0.15	0.5±0.15	0.5±0.15	H / N(*)	
0.47μF				M:±20%		4	CM05X7S225M04A#065	5.0	1.0±0.15	0.5±0.15	0.5±0.15	H / N(*)
						10	CM05X7T475M10A#	12.5	1.0±0.2	0.5±0.2	0.5±0.2	H / N(*)

General CM105 Series Size (JIS Code) : 0603(1608) # Packaging Code (Packaging quantity) : T(4,000pcs.) / L(10,000pcs.)

Dielectric code	Capacitance	□:Tolerance	Voltage [V]	Part Number	Tanδ [%]	Dimension			# Packaging Code (quantity)			
						L[mm]	W[mm]	T[mm]				
X5R	2.2μF	K:±10% / M:±20%	16	CM105X5R225□16A#	12.5	1.6±0.1	0.8±0.1	0.8±0.1	T / L			
			35	CM105X5R475□35A#	12.5	1.6±0.2	0.8±0.2	0.8±0.2	T / L			
	4.7μF		M:±20%	25	CM105X5R475□25A#	12.5	1.6±0.2	0.8±0.2	0.8±0.2	T / L		
				10	CM105X5R475□10A#	12.5	1.6±0.15	0.8±0.15	0.8±0.15	T / L		
	10μF			K:±10% / M:±20%	35	CM105X5R106M35A#	15.0	1.6±0.2	0.8±0.2	0.8±0.2	T / L	
					25	CM105X5R106□25A#	15.0	1.6±0.2	0.8±0.2	0.8±0.2	T / L	
	22μF				M:±20%	16	CM105X5R226M16A#	12.5	1.6±0.2	0.8±0.2	0.8±0.2	T / L
						10	CM105X5R226M10A#	12.5	1.6±0.2	0.8±0.2	0.8±0.2	T / L
47μF	M:±20%	6.3				CM105X5R476M06A#	12.5	1.6±0.2	0.8±0.2	0.8±0.2	T / L	
		16				CM105X6S106M16A#	15.0	1.6±0.2	0.8±0.2	0.8±0.2	T / L	
10μF		K:±10% / M:±20%	10			CM105X6S106□10A#	15.0	1.6±0.2	0.8±0.2	0.8±0.2	T / L	
			10			CM105X6S226M10A#	12.5	1.6±0.2	0.8±0.2	0.8±0.2	T / L	
22μF			M:±20%	6.3		CM105X6S226M06A#	12.5	1.6±0.2	0.8±0.2	0.8±0.2	T / L	
				4		CM105X6S226M04A#	12.5	1.6±0.2	0.8±0.2	0.8±0.2	T / L	
47μF				M:±20%	4	CM105X6S476M04A#	12.5	1.6±0.2	0.8±0.2	0.8±0.2	T / L	
					25	CM105X7R105□25A#	5.0	1.6±0.1	0.8±0.1	0.8±0.1	T / L	
1μF	K:±10% / M:±20%				6.3	CM105X7R225□06A#	12.5	1.6±0.15	0.8±0.15	0.8±0.15	T / L	
					10	CM105X7T475□10A#	12.5	1.6±0.2	0.8±0.2	0.8±0.2	T / L	
2.2μF		K:±10% / M:±20%			10	CM105X7T106M10A#	15.0	1.6±0.2	0.8±0.2	0.8±0.2	T / L	
					6.3	CM105X7T106M06A#	15.0	1.6±0.2	0.8±0.2	0.8±0.2	T / L	
4.7μF			M:±20%		10	CM105X7T226M10A#	15.0	1.6±0.2	0.8±0.2	0.8±0.2	T / L	
					6.3	CM105X7T226M06A#	15.0	1.6±0.2	0.8±0.2	0.8±0.2	T / L	

General CM21 Series Size (JIS Code) : 0805(2012) # Packaging Code (Packaging quantity) : T(3,000pcs.) / L(10,000pcs.)

Dielectric code	Capacitance	□:Tolerance	Voltage [V]	Part Number	Tanδ [%]	Dimension			# Packaging Code (quantity)		
						L[mm]	W[mm]	T[mm]			
X5R	1μF	K:±10% / M:±20%	50	CM21X5R105□50A#	12.5	2.0±0.1	1.25±0.1	1.25±0.1	T / L		
			25	CM21X5R225□25A#	12.5	2.0±0.2	1.25±0.2	1.25±0.2	T / L		
	2.2μF		M:±20%	16	CM21X5R106□16A#	12.5	2.0±0.2	1.25±0.2	1.25±0.2	T / L	
				25	CM21X5R226M25A#	12.5	2.0±0.2	1.25±0.2	1.25±0.2	T / L	
	10μF			M:±20%	10	CM21X5R226M10A#	12.5	2.0±0.2	1.25±0.2	1.25±0.2	T / L
					6.3	CM21X5R476M06A#	10.0	2.0±0.2	1.25±0.2	1.25±0.2	T / L
47μF	M:±20%	4			CM21X5R107M04A#	12.5	2.0±0.2	1.25±0.2	1.25±0.2	T / L	
		100μF			M:±20%	16	CM21X6S226M16A#	12.5	2.0±0.2	1.25±0.2	1.25±0.2
22μF		M:±20%	10			CM21X6S226M10A#	12.5	2.0±0.2	1.25±0.2	1.25±0.2	T / L
			6.3			CM21X6S226M06A#	12.5	2.0±0.2	1.25±0.2	1.25±0.2	T / L
47μF			M:±20%	4		CM21X6S476M04A#	10.0	2.0±0.2	1.25±0.2	1.25±0.2	T / L
				100μF		M:±20%	4	CM21X6S107M04A#	12.5	2.0±0.2	1.25±0.2
1μF	K:±10% / M:±20%			50			CM21X7R105□50A#	5.0	2.0±0.2	1.25±0.2	1.25±0.2
				25	CM21X7R225□25A#		12.5	2.0±0.2	1.25±0.2	1.25±0.2	T / L
2.2μF		K:±10% / M:±20%		16	CM21X7R475□16A#		12.5	2.0±0.2	1.25±0.2	1.25±0.2	T / L
				6.3	CM21X7R106□06A#		12.5	2.0±0.2	1.25±0.2	1.25±0.2	T / L
4.7μF			K:±10% / M:±20%	100	CM21X7S105□100A#		5.0	2.0±0.2	1.25±0.2	1.25±0.2	T / L
				10	CM21X7T226M10A#	12.5	2.0±0.2	1.25±0.2	1.25±0.2	T / L	
10μF	M:±20%			6.3	CM21X7T226M06A#	12.5	2.0±0.2	1.25±0.2	1.25±0.2	T / L	
				6.3	CM21X7T226M06A#	12.5	2.0±0.2	1.25±0.2	1.25±0.2	T / L	

Part Number List

General CM316 Series Size (JIS Code) : 1206(3216) # Packaging Code (Packaging quantity) : T(2,500pcs.)*2,000pcs. / L(5,000pcs.)

Dielectric code	Capacitance	□:Tolerance	Voltage [V]	Part Number	Tanδ [%]	Dimension			# Packaging Code (quantity)	
						L[mm]	W[mm]	T[mm]		
X5R	2.2μF	K:±10% / M:±20%	100	CM316X5R225□100A#	5.0	3.2±0.2	1.6±0.2	1.6±0.2	T / L	
			25	CM316X5R225□25A#	5.0	3.2±0.2	1.6±0.15	1.6±0.15	T / L	
			50	CM316X5R475□50A#	5.0	3.2±0.2	1.6±0.2	1.6±0.2	T / L	
			25	CM316X5R106□25A#	12.5	3.2±0.2	1.6±0.2	1.6±0.2	T / L	
			16	CM316X5R226□16A#	12.5	3.2±0.2	1.6±0.2	1.6±0.2	T / L	
X7R	4.7μF	K:±10% / M:±20%	50	CM316X7R475□50A#	5.0	3.2±0.2	1.6±0.2	1.6±0.2	T / L	
			25	CM316X7R106□25A#	5.0	3.2±0.2	1.6±0.2	1.6±0.2	T / L	
			16	CM316X7R106□16A#	12.5	3.2±0.2	1.6±0.2	1.6±0.2	T / L	
			10	CM316X7R226□10A#	7.5	3.2±0.2	1.6±0.2	1.6±0.2	T / L	
			6.3	CM316X7R226□06A#	12.5	3.2±0.2	1.6±0.2	1.6±0.2	T / L	
X7S	2.2μF	K:±10% / M:±20%	100	CM316X7S225□100A#	5.0	3.2±0.2	1.6±0.2	1.6±0.2	T / L	
			4.7μF	CM316X7S475□100AT	5.0	3.2±0.3	1.6±0.3	1.6±0.3	T(*)	
			22μF	10	CM316X7S226□10A#	7.5	3.2±0.2	1.6±0.2	1.6±0.2	T / L

General CM32 Series Size (JIS Code) : 1210(3225) # Packaging Code (Packaging quantity) : T(1,000pcs.) / L(4,000pcs.)

Dielectric code	Capacitance	□:Tolerance	Voltage [V]	Part Number	Tanδ [%]	Dimension			# Packaging Code (quantity)
						L[mm]	W[mm]	T[mm]	
X5R	10μF	K:±10% / M:±20%	50	CM32X5R106□50A#	5.0	3.2±0.3	2.5±0.2	2.5±0.2	T / L
			25	CM32X5R106□25A#	12.5	3.2±0.3	2.5±0.2	2.5±0.2	T / L
			16	CM32X5R106□16A#	5.0	3.2±0.3	2.5±0.2	2.5±0.2	T / L
			25	CM32X5R226□25A#	12.5	3.2±0.3	2.5±0.2	2.5±0.2	T / L
X7R	10μF	K:±10% / M:±20%	50	CM32X7R106□50A#	5.0	3.2±0.3	2.5±0.2	2.5±0.2	T / L
			25	CM32X7R106□25A#	12.5	3.2±0.3	2.5±0.2	2.5±0.2	T / L
			16	CM32X7R226□16A#	12.5	3.2±0.3	2.5±0.2	2.5±0.2	T / L



Notes for Using the Catalog

1. Specifications described in this catalog are for references. Products specifications shall be based on written documents agreed by each party.
2. Contents in this catalog are subject to change without notice. It is recommended to confirm the latest information at the time of usage. Also, Kyocera Electronic Components Catalog is revised once a year. We may not be able to accept requests based on old catalogs.
3. Products in this catalog are intended to be used in general electronic equipment such as office equipment, audio and visual equipment, communication equipment, measurement instrument and home appliances. It is absolutely recommended to consult with our sales representatives in advance upon planning to use our products in applications which require extremely high quality and reliability such as aircraft and aerospace equipment, traffic systems, safety systems, power plant and medical equipment including life maintenance systems.
4. Even though we strive for improvements of quality and reliability of products, it is requested to design with enough safety margin in equipment or systems in order not to threaten human lives directly or damage human bodies or properties by an accidental result of products.
5. It is requested to design based on guaranteed specifications for such as maximum ratings, operating voltage and operating temperature. It is not the scope of our guarantee for unsatisfactory results due to misuse or inadequate usage of products in the catalog.
6. Operation summaries and circuit examples in this catalog are intended to explain typical operation and usage of the product. It is recommended to perform circuit and assembly design considering surrounding conditions upon using products in this catalog.
7. Technical information described in this catalog is meant to explain typical operations and applications of products, and it is not intended to guarantee or license intellectual properties or other industrial rights of the third party or Kyocera.
8. Trademarks, logos and brand names used in this catalog are owned by Kyocera or the corresponding third party.
9. Certain products in this catalog are subject to the Foreign Exchange and Foreign Trade Control Act of Japan, and require the license from Japanese Government upon exporting the restricted products and technical information under the law.
Besides, it is requested not to use products and technical information in the catalog for the development and/or manufacture of weapons of mass destruction or other conventional weapons, nor to provide them to any third party with the possibility of having such purposes.
10. It is prohibited to reprint and reproduce a part or whole of this catalog without permission.
11. Contents described herein are as of October 2022.

X-ON Electronics

Largest Supplier of Electrical and Electronic Components

Click to view similar products for [Multilayer Ceramic Capacitors MLCC - SMD/SMT category:](#)

Click to view products by [Kyocera AVX manufacturer:](#)

Other Similar products are found below :

[M39014/02-1218V](#) [M39014/02-1225V](#) [M39014/02-1301](#) [M39014/22-0631](#) [M39014/22-0808](#) [NIN-FC2R7JTRF](#) [C1608C0G2A221J](#)
[C1608X7R1E334K](#) [C2012C0G2A472J](#) [CL10C0R8BB8ANNC](#) [C1005X5R0G225M](#) [C3216C0G2J272J](#) [726632-1](#) [CGA3E2X8R1H223K](#)
[CDR35BX474AKUR\M500](#) [C1608X8R1H473K](#) [M39014/01-1554](#) [4327 030 36981](#) [CDR06BX474AMSP\M](#) [CDR31BP330BJMS\M](#)
[M39014/220214](#) [CHP1-100-8202-G-LF674A](#) [502R29N330JV3E-](#) [0603B103J500NT](#) [1206B103K501NT](#) [0402N820J101CT](#)
[1206N221J202CT](#) [0805N330J102CT](#) [1206N220J501CT](#) [1206N151J500CT](#) [1206N103J101CT](#) [0603B152K201CT](#) [RF18N5R0B500CT](#)
[0603B472K201CT](#) [0805B272K101CT](#) [0603N1R0C251CT](#) [0805B153K201CT](#) [1210B333K101CT](#) [CC0100JRNPO8BN100](#)
[CC0100JRNPO6BN101](#) [CC0402JRNPO9BN301](#) [CC0805KKX7R0BB105](#) [AC0805KKX7R6BB475](#) [CC0805KKX7R7BB824](#)
[CQ0402DRNPO9BN5R6](#) [AF0100FR-07200KL](#) [CC0603DRNPO9BN5R1](#) [CC0805GKNPO9BN472](#) [CC1206JKX7R9BB474](#)
[CC1206JRX7R8BB474](#)