

Specification

| | |
|--------------|----------------------------|
| Drawing No. | UKY1C-H1-16236-00[43] 1/10 |
| Issued Date. | Mar. 3,2016 |

TO: IHS Technology

Note: In case of specification change, KYOCERA Part Number also will be changed.

| | |
|-------------------------------|---|
| Product Name | Quartz Crystal |
| Product Model | CX3225CA |
| Frequency | 26000kHz |
| Customer Part Number | - |
| Customer Specification Number | - |
| KYOCERA Part Number | CX3225CA26000D0HSSCC |
| Remarks | RoHS Compliant, MSL 1 AEC-Q200 Compliant |

Customer Acceptance

| | | |
|------------------|------------------|--|
| Accept Signature | Approved Date | |
| | | |
| | Department | |
| | | |
| | Person in charge | |
| | | |

Seller

KYOCERA Crystal Device Corporation

(Sales Division)

6 Takeda Tobadono-cho, Fushimi-ku, Kyoto

612-8501 Japan

TEL. No. 075-604-3500

FAX. No. 075-604-3501

Manufacturer

Crystal Units Division

5850, Higashine-Koh, Higashine-Shi, Yamagata

999-3701 Japan

TEL. No. 0237-43-5611

FAX. No. 0237-43-5615

| Design Department | Quality Assurance | Approved by | Examination by | Issued by |
|---|-------------------|-------------|----------------|--------------|
| KYOCERA Crystal Device Corporation Crystal Units Engineering Section Crystal Units Division | T. Noritake | H. Shoji | A. Ito | M. Hashimoto |

Revision History

| Rev.No. | Description of revise | Date | Approved by | Examination by | Issued by |
|---------|-----------------------|-------------|-------------|----------------|-------------|
| 1 | First Edition | Mar. 3,2016 | H. Shoji | A.Ito | M.Hashimoto |

1. APPLICATION

This specification sheet is applied to quartz crystal “CX3225CA26000D0HSSCC”

2. KYOCERA PART NUMBER

CX3225CA26000D0HSSCC

3. RATINGS

| Items | SYMB. | Rating | Unit | Remarks |
|---------------------------|-------|-------------|------|---------|
| Operating Temperature | Topr | -40 to +125 | °C | |
| Storage Temperature Range | Tstg | -40 to +150 | °C | |

4. CHARACTERISTICS
ELECTRICAL CHARACTERISTICS

| Items | Electrical Specification | | | | | Test Condition | Remarks |
|---------------------------------------|--------------------------|-------------|------|-------|------|----------------------|---------|
| | SYMB. | Min. | Typ. | Max. | Unit | | |
| Mode of Vibration | | Fundamental | | | | | |
| Nominal Frequency | F0 | | 26 | | MHz | | |
| Nominal Temperature | T _{NOM} | | +25 | | °C | | |
| Load Capacitance | CL | 8.0 | | | pF | | |
| Frequency Tolerance | df/F | -20.0 | | +20.0 | PPM | +25±3°C | |
| Frequency Temperature Characteristics | df/F | -50.0 | | +50.0 | | -40 to +125°C | |
| Frequency Aging Rate | | -5.0 | | +5.0 | | 1 st year | +25±3°C |
| Equivalent Series Resistance | ESR | | | 100 | Ω | | |
| Drive Level | Pd | 0.01 | | 200 | μW | | |
| Insulation Resistance | IR | 500 | | | MΩ | 100V(DC) | |

5. Measurement Condition

5.1 Frequency measurement

Measuring instrument : IEC PI-Network Test Fixture
Load Capacitance : 8.0pF
Drive Level : 10 μ W

5.2 Equivalent series resistance (ESR) measurement

Measuring instrument : IEC PI-Network Test Fixture
Load Capacitance : Series
Drive Level : 10 μ W

6. APPEARANCES, PHYSICAL DIMENSION
OUTLINE DIMENSION (not to scale)

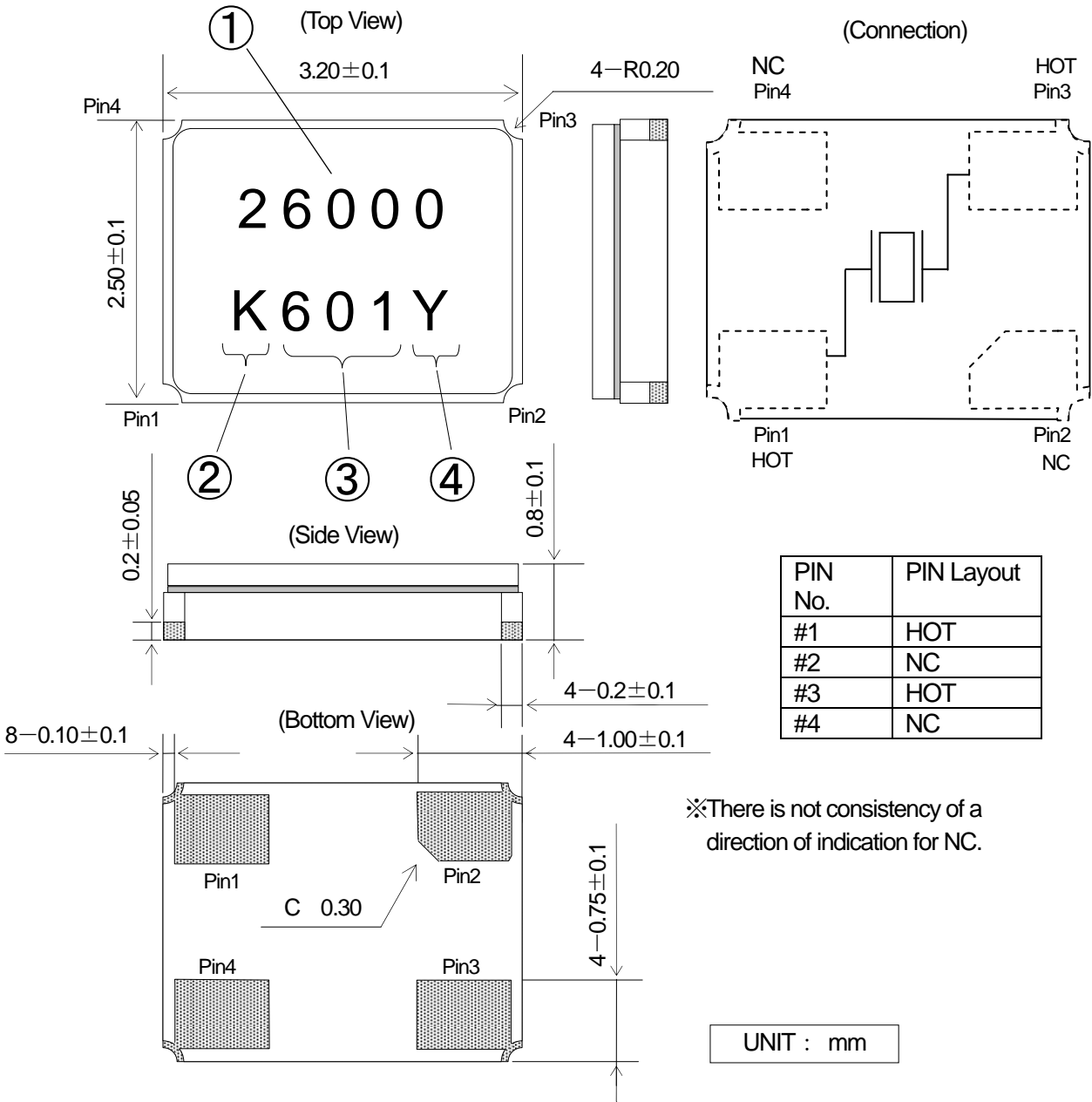

MARKING

- | | |
|--------------------------|--|
| 1 Nominal Frequency | Move the number of maximum indication beams of the frequency to five digits, and omit less than kHz. |
| 2 Identification | |
| 3 Date Code | Year ···LAST 1 DIGIT of YEAR AND WEEK (Ex) Jan. 1, 2016 → 601 |
| 4 Manufacturing Location | Y···Japan(Yamagata) T···Thailand |

※The font of marking is reference.

7. RECOMMENDED LAND PATTERN (not to scale)

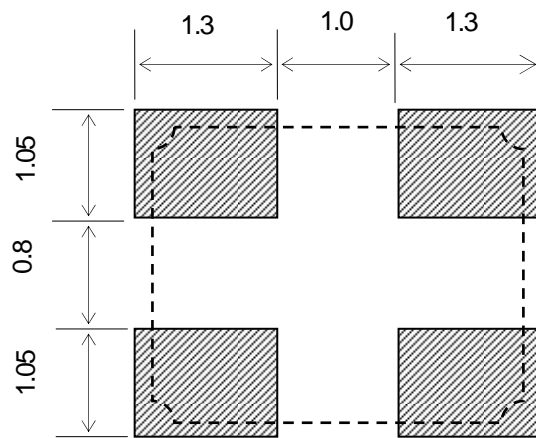

UNIT : mm

8.TAPING & REEL

8-1.Dimensions

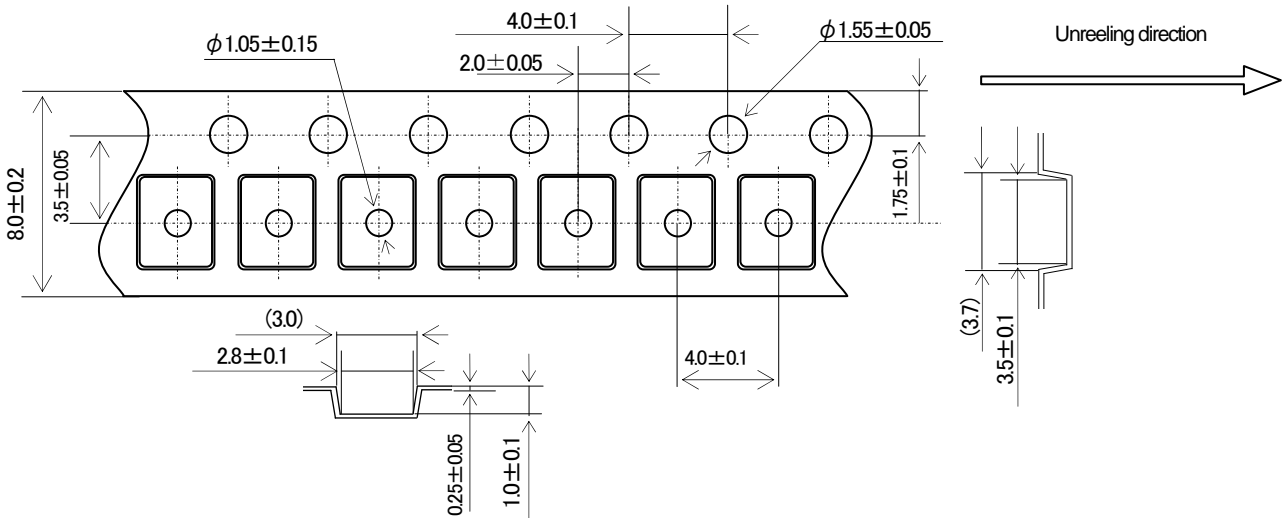

8-2.Leader and trailer tape

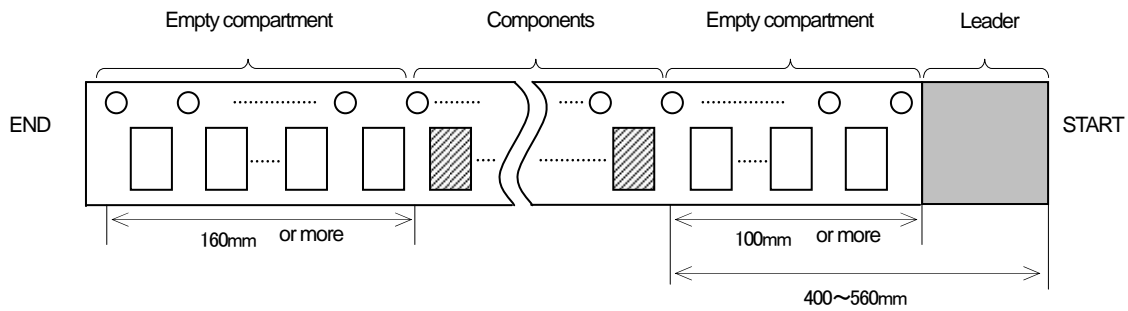

8-3.Direction (The direction shall be seen from the top cover tape side)

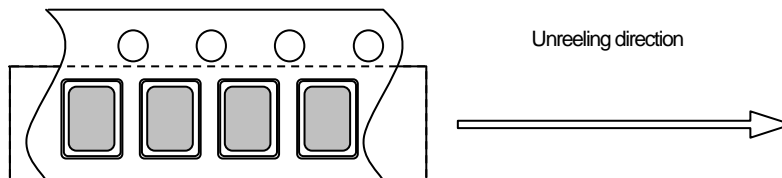

8-4.Specification

1. Material of the carrier tape is either polystyrene or A-PET (ESD).
2. Material of the cover tape is polyester (ESD).
3. The seal tape shall not cover the sprocket holes and not protrude from the carrier tape.
4. Tensile strength of carrier tape: 10N or more.
5. The R of the corner of each cavity is 0.2RMAX.
6. The alignment between centers of the cavity and sprocket hole shall be 0.05mm or less.
7. Peeling force of cover tape: 0.1 to 1.0N.
8. The component will fall out naturally when cover tape is removed and set upside down.
9. The marking on parts is not fixed its direction, its electrical characteristic is equal.

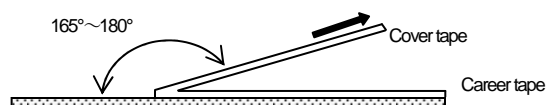

8-5.Reel specifications

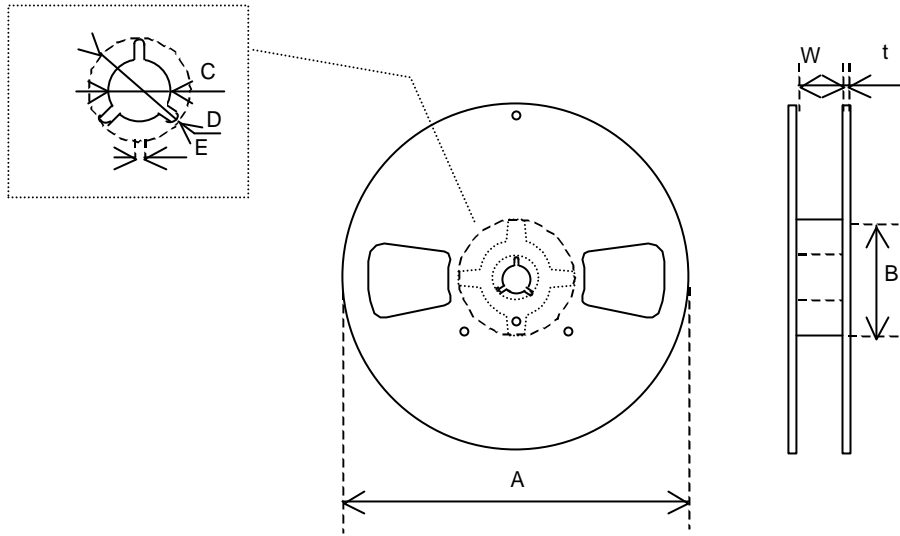

(Nonconductor type Reel)

Φ180 Reel (3000pcs max.)

| | A | B | C | D |
|-----------|--------------------|-----------------|-------------------|-------------------|
| Dimension | $\phi 180 +0/-1.5$ | $\phi 60 +1/-0$ | $\phi 13 \pm 0.2$ | $\phi 21 \pm 0.8$ |
| Symbol | E | W | t | |
| Dimension | 2.0 ± 0.5 | 9 ± 1 | 2.0 ± 0.5 | |

(Unit : mm)

9.Environmental requirements

(Reference: AEC-Q200 Rev. D. The solder used by examination is hereafter set to Sn-3Ag-0.5Cu.)

After following test, Frequency applies to each item and CI, ±20% or 5Ω of large value.

| No | Stress | Reference | Additional Requirements |
|------|-------------------------------------|-------------------------|---|
| 9.1 | High Temperature Exposure (Storage) | MIL-STD-202 Method 108 | 1000 hrs. at rated operating temperature (e.g. 85°C part can be stored for 1000 hrs at 85°C. Same applies for 125°C). Unpowered. Measurement at 24±4 hours after test conclusion. |
| 9.2 | Temperature Cycling | JESD22 Method JA-104 | 1000 cycles (-40°C to 125°C) Note: If 85°C part the 1000 cycles will be at that temperature rating. Measurement at 24±4 hours after test conclusion. 30min maximum dwell time at each temperature extreme. 1 min. maximum transition time. |
| 9.3 | Biased Humidity | MIL-STD- 202 Method 103 | 1000 hours 85°C/85%RH. Rated VDD applied with 1 MW and inverter in parallel, 2X crystal CL capacitors between each crystal leg and GND. Measurement at 24±4 hours after test conclusion. |
| 9.4 | Operational Life | MIL-STD- 202 Method 108 | Note: 1000 hrs @ 125°C. If 85°C part will be tested at that temperature. Rated VDD applied with 1 MW and inverter in parallel, 2X crystal CL capacitors between each crystal leg and GND. Measurement at 24±4 hours after test conclusion. |
| 9.5 | Terminal Strength (Leaded) | MIL-STD- 202 Method 211 | Test leaded device lead integrity only. Conditions: A (227 g), C (227 g). |
| 9.6 | Resistance to Solvents | MIL-STD- 202 Method 215 | Note: Also aqueous wash chemical - OKEM clean or equivalent. Do not use banned solvents. |
| 9.7 | Mechanical Shock | MIL-STD-202 Method 213 | Figure 1 of Method 213. Condition C |
| 9.8 | Vibration | MIL-STD-202 Method 204 | 5g's for 20 minutes 12 cycles each of 3 orientations. Note: Use 8"X5" PCB .031" thick with 7 secure points on one 8" side and 2 secure points on corners of opposite sides. Parts mounted within 2" from any secure point. Test from 10-2000 Hz. |
| 9.9 | Resistance to Soldering Heat | MIL-STD-202 Method 210 | Condition B No pre-heat of samples. Note: Single Wave solder - Procedure 1 with solder within 1.5 mm of device body for Leaded. Procedure 1 except 230°C and immerse only to level to cover terminals for SMD. |
| 9.10 | Solder ability | J-STD-002 | For both Leaded & SMD. Electrical Test not required. Magnification 50 X. Conditions: Leaded: Method A @ 235°C, category 3. SMD: a) Method B, 4 hrs @ 155°C dry heat @ 235°C b) Method B @ 215°C category 3. c) Method D category 3 @ 260°C. |
| 9.11 | Flammability | UL-94 | V-0 or V-1 Acceptable |
| 9.12 | Board Flex | AEC Q200-005 | 60 sec minimum holding time. |
| 9.13 | Terminal Strength(SMD) | AEC Q200-006 | - |

10. Cautions for use

(1) Soldering upon mounting

There is a possibility to influence product characteristics when Solder paste or conductive glue comes in contact with product lid or surface.

(2) When using mounting machine

Please minimize the shock when using mounting machine to avoid any excess stress to the product.

(3) Conformity of a circuit

We strongly recommend to make sure that Negative resistance (Gain) of IC is designed to be 10 times the ESR (Equivalent Series Resistance) of crystal unit.

- (4) After making the Quartz Crystal mount on a printed circuit board ,if it is required to divide the printed circuit board into another one, use it with attentive confirmation so that a warp caused by this dividing might not affect any damage. When designing a printed circuit board as well as handling the mounting As much as possible. The quartz crystal shall be passed through the reflow furnace. Then it shall be subjected to standard atmospheric conditions, after which cleaning shall be made.

11. Storage conditions

Please store product in below conditions, and use within 6 months.

Temperature +18 to +30°C, and Humidity of 20 to 70 % in the packaging condition.

12. Manufacturing location

Kyocera Crystal Device Corporation / Japan(Yamagata)

Kyocera Crystal Device (Thailand) Co., Ltd / Thailand(Lamphun)

13. Quality Assurance

To be guaranteed by Kyocera Crystal Device Quality Assurance Division

14. Quality guarantee

In case when Kyocera Crystal Device Corporation rooted failure occurred within 1year after its delivery, substitute product will be arranged based on discussion. Quality guarantee of product after 1year of its delivery is waived.

15. Others

In case of any questions or opinions regarding the Specification, please have it in written manner within 45 days after issued date.

X-ON Electronics

Largest Supplier of Electrical and Electronic Components

Click to view similar products for [Crystals](#) category:

Click to view products by [Kyocera AVX](#) manufacturer:

Other Similar products are found below :

[MC405 32.0000K-R3:PURE SN](#) [7A-40.000MAAE-T](#) [7B-27.000MBBK-T](#) [MP1-8.0 99-BU](#) [9B-15.360MBBK-B](#) [PTX-A2JM-10.000M](#) [9C-7.680MBBK-T](#) [H10S-12.000-18-EXT-TR](#) [R38-32.768-12.5-5PPM-NPB](#) [BTD1062E05A-513](#) [21U15A-21.4MHZ](#) [RTX-781DF1-S-20.950](#) [LFX TAL066198Cutt](#) [9C-14.31818MBBK-T](#) [A-11.000MHZ-27](#) [SPT2A-.032768B](#) [SPT2A.032768G](#) [SSPT7F-9PF20-R](#) [FX325BS-38.88EEM1201](#) [MP-1-25.000MHZ-3L](#) [MP-1-6.000MHZ](#) [LFX TAL065253Cutt](#) [LFX TAL066431Cutt](#) [XT9S20ANA14M7456](#) [XT9SNLANA16M](#) [646G-24-2](#) [7A-24.576MBBK-T](#) [7B-30.000MBBK-T](#) [7A-14.31818MBBK-T](#) [6526-202-1501](#) [BTJ120E02C](#) [SG636PCE-20.000MC](#) [3404](#) [CM315D32768EZFT](#) [C1E-24.000-7-2020-R](#) [C1E-19.200-12-1530-X-R](#) [C1E-16.000-12-1530-X-R](#) [ABM11-16.000MHZ-9-B1U-T](#) [FL5000014](#) [EUCA18-3.1872M](#) [425F35E027M0000](#) [17196](#) [ABM3-13.52313MHZ-10-B4Y-T](#) [MS3V-T1R-32.768kHz-7pF-20PPM-TA-QC-Au](#) [VXM7-1C1-16M000](#) [MS1V-T1K-32.768kHz-10pF-20PPM-TA-QC-Au](#) [MS3V-T1R-32.768kHz-9pF-20PPM-TA-QC-Au](#) [ECS-80-18-30-JGN-TR](#) [17000](#)