

Thin-Film RF/Microwave Directional Couplers

CP0302/CP0402/CP0603/CP0805 and DB0603N/DB0805 3dB 90° DB0805 3dB 90° Couplers



GENERAL DESCRIPTION ITF TECHNOLOGY

The ITF SMD 3dB 90° Coupler is based on thin-film multilayer technology. The technology provides a miniature part with excellent high frequency performance and rugged construction for reliable automatic assembly.

The ITF 3dB 90° Coupler is offered in a variety of frequency bands compatible with various types of high frequency wireless systems.

APPLICATIONS

- Balanced Amplifiers and Signal Distribution in Mobile Communications

FEATURES

- Miniature 0805 size
- Low I. Loss
- High Isolation
- Power Handling: 10W RF CW
- Surface Mountable
- Supplied on Tape & Reel
- Operating Temperature -40°C to +85°C

RECOMMENDED PAD LAYOUT DIMENSIONS:

millimeters (inches)

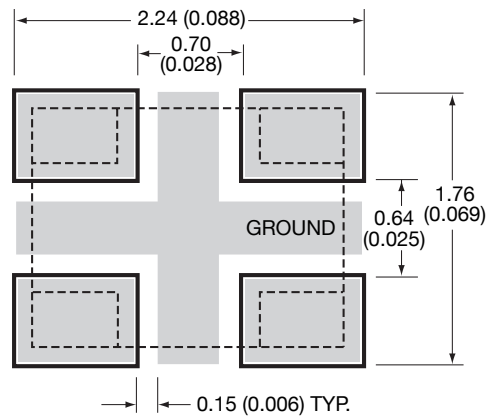

DIMENSIONS:

millimeters (inches)

L	2.03±0.10 (0.080±0.004)
W	1.55±0.10 (0.061±0.004)
T	0.98±0.15 (0.037±0.006)
A	0.56±0.25 (0.022±0.010)
B	0.35±0.15 (0.014±0.006)

BOTTOM VIEW

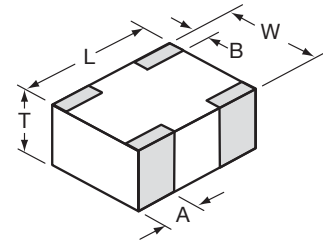

ELECTRICAL PARAMETERS*

Part Number**	Frequency FO [MHz]	I. Loss @ F _o [dB]	Phase Balance [deg] max.	Code Letter Marking
DB0805A0870ASTR	870±70	0.4	3	Y
DB0805A0880ASTR	880±30	0.35	3	Y
DB0805A0915ASTR	915±30	0.35	3	V
DB0805A0967ASTR	967±30	0.35	3	V
DB0805A1176ASTR	1176±13	0.2	3	G
DB0805A1350ASTR	1350±50	0.35	3	C
DB0805A1376ASTR	1376±211	0.6	8	G
DB0805A1650ASTR	1650±50	0.35	3	F
DB0805A1800ASTR	1800±50	0.30	3	F
DB0805A1850ASTR	1850±50	0.30	3	K
DB0805A1900ASTR	1900±50	0.30	3	K
DB0805A1950ASTR	1950±50	0.25	3	K
DB0805A2140ASTR	2140±50	0.25	3	L
DB0805A2325ASTR	2325±50	0.25	3	T

*With Recommended Pad Layout

NOTE: Additional Frequencies Available Upon Request

TERMINALS (TOP VIEW) ORIENTATION IN TAPE

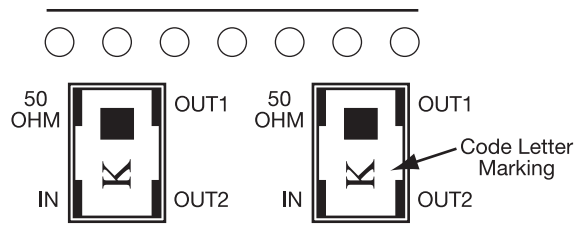

**LEAD FREE TERMINATION

PART NUMBERS:
DB0805AXXXXASTR



Thin-Film RF/Microwave Directional Couplers

CP0302/CP0402/CP0603/CP0805 and DB0603N/DB0805 3dB 90°

DB0805 3dB 90° Couplers



870 ± 13MHZ DB0805A0870ASTR

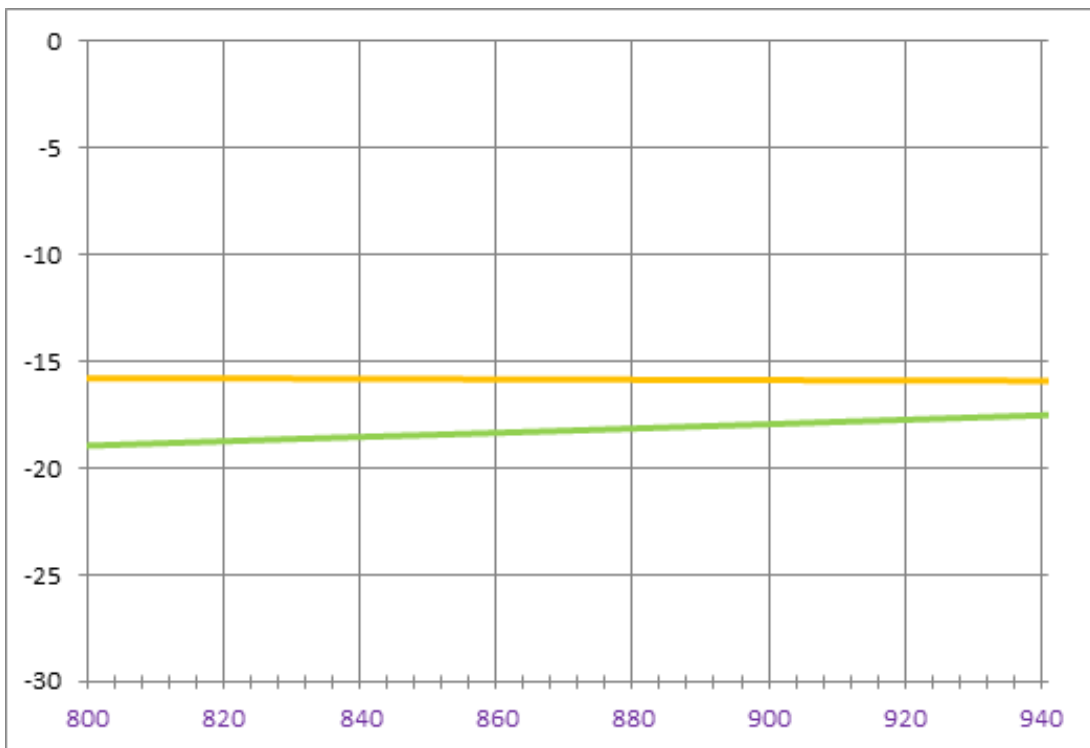
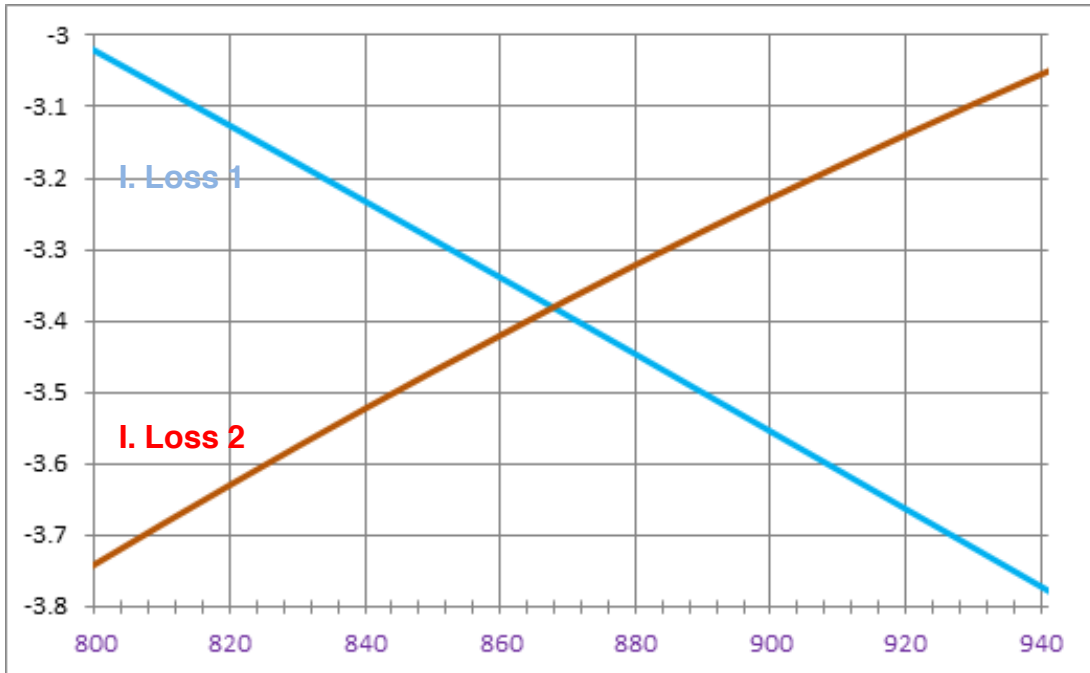

Thin-Film RF/Microwave Directional Couplers

CP0302/CP0402/CP0603/CP0805 and DB0603N/DB0805 3dB 90°

DB0805 3dB 90° Couplers



880 ± 30MHz DB0805A0880ASTR

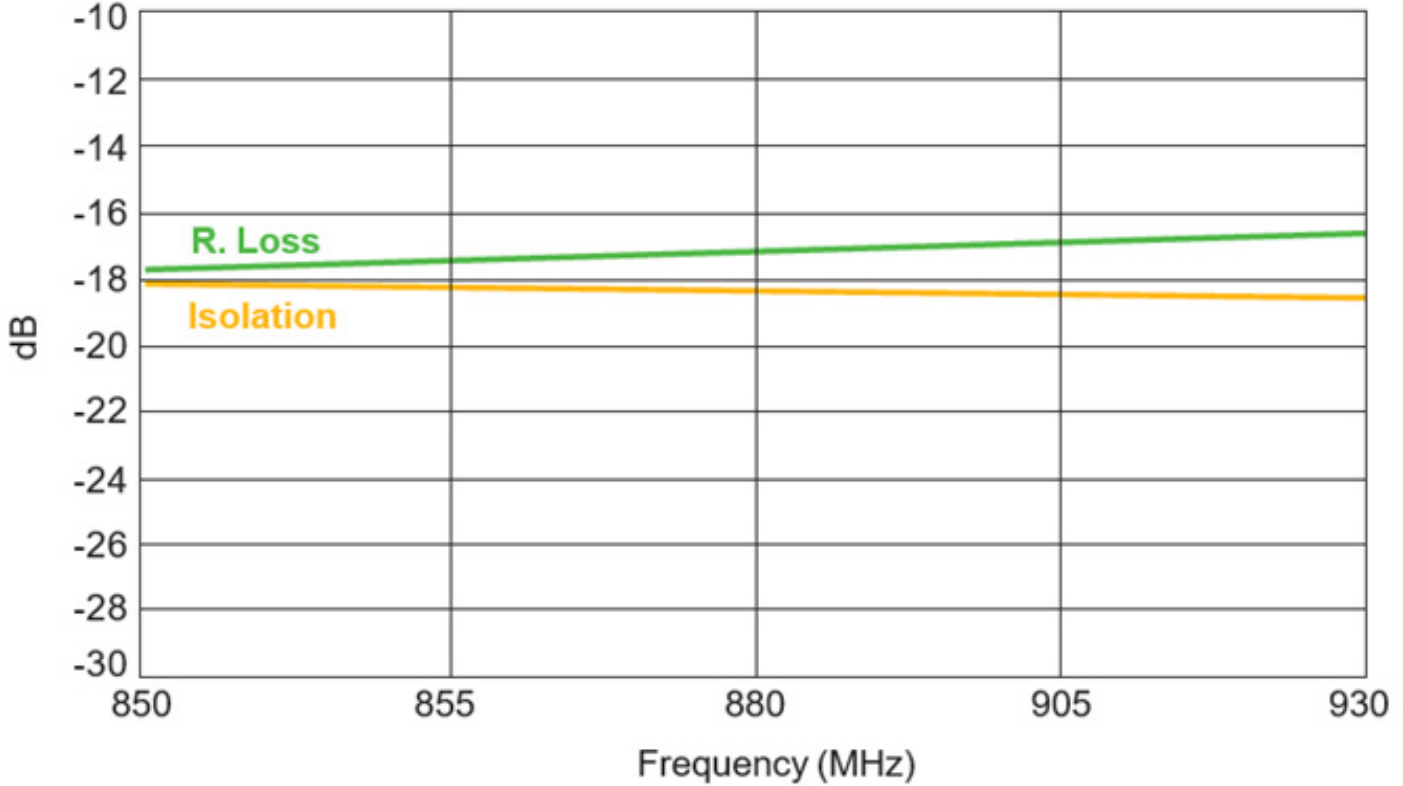
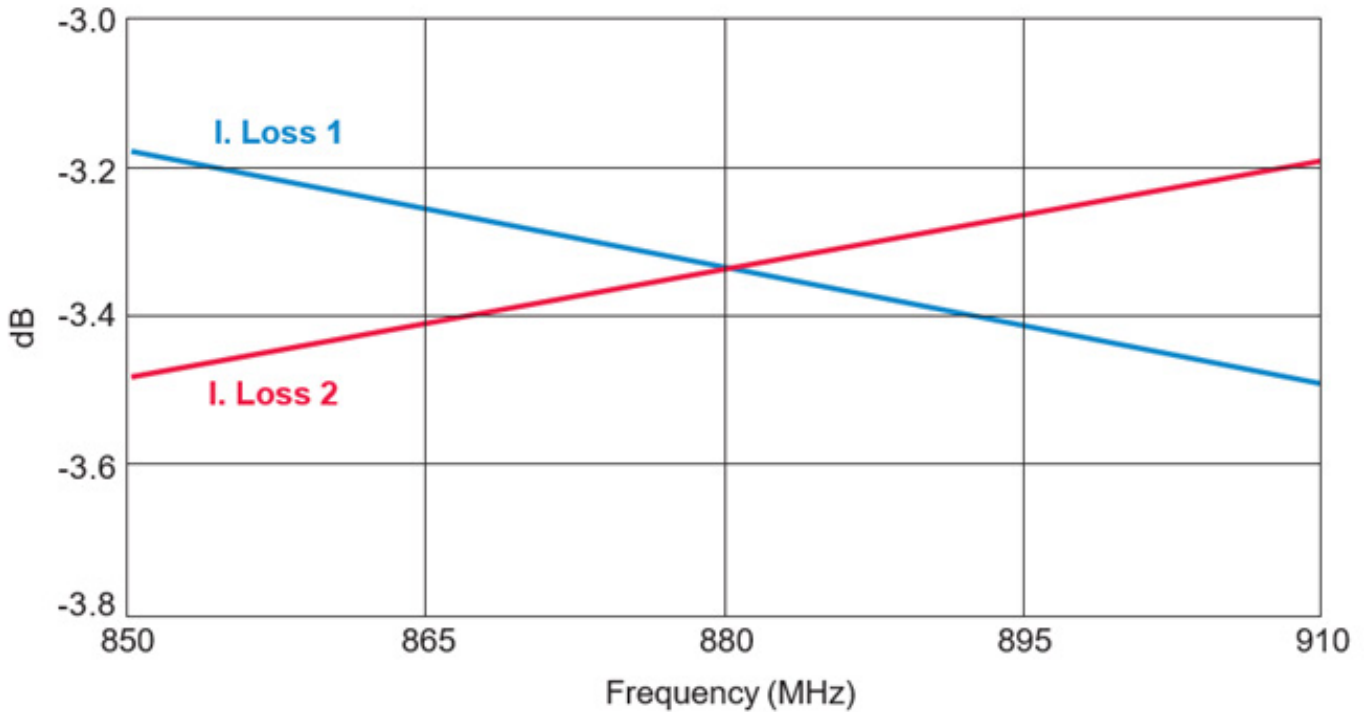

Thin-Film RF/Microwave Directional Couplers

CP0302/CP0402/CP0603/CP0805 and DB0603N/DB0805 3dB 90°

DB0805 3dB 90° Couplers



915 ± 30MHz DB0805A0915ASTR

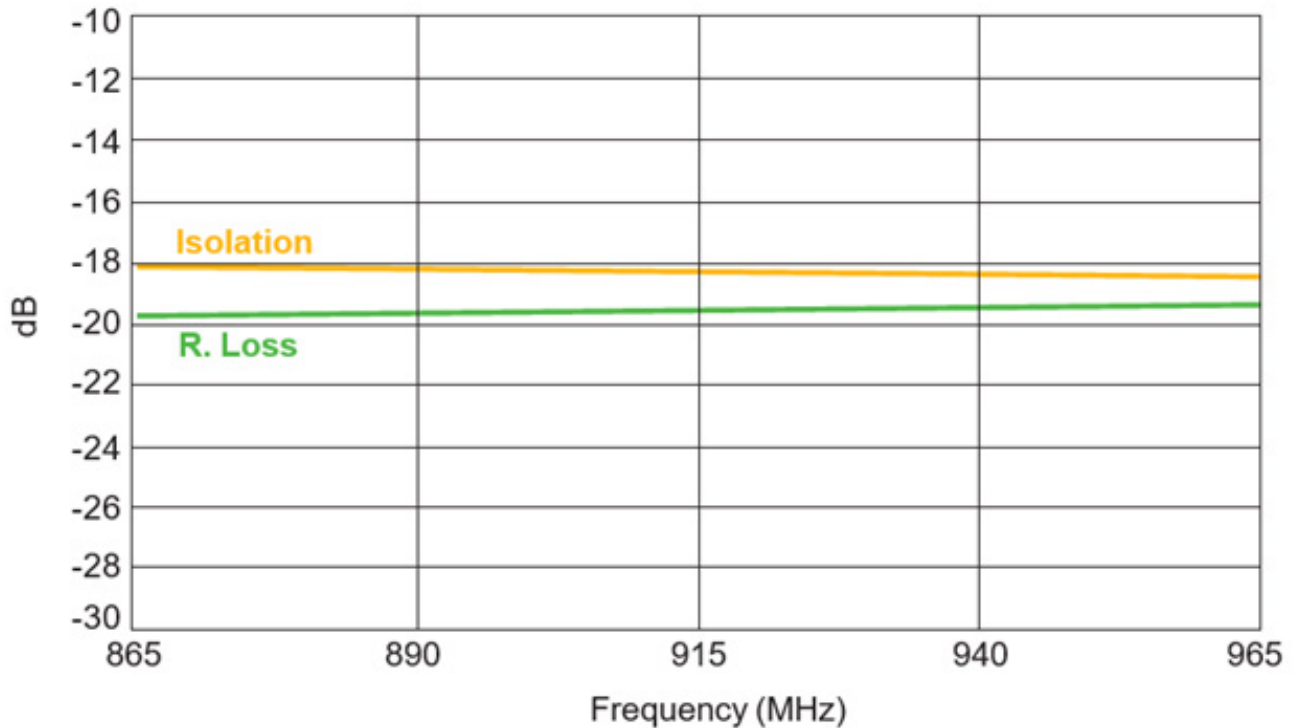
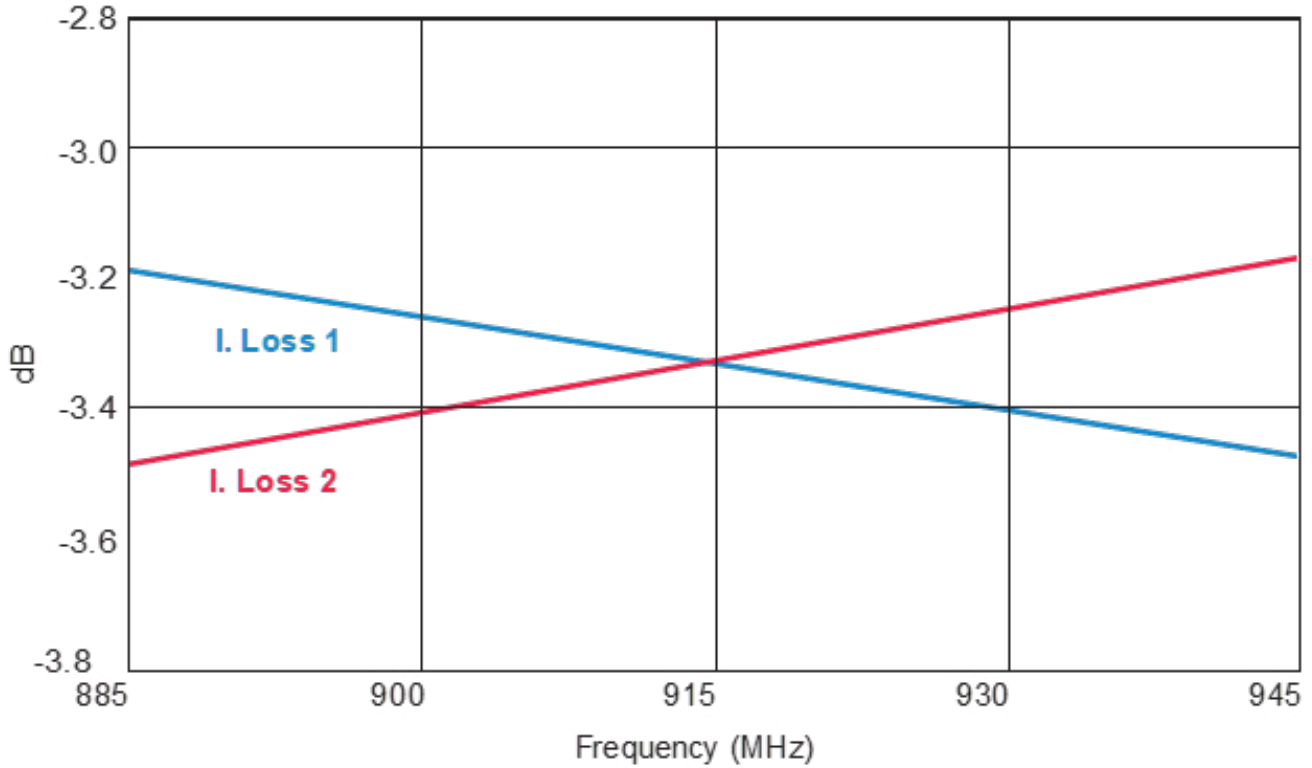

Thin-Film RF/Microwave Directional Couplers

CP0302/CP0402/CP0603/CP0805 and DB0603N/DB0805 3dB 90°

DB0805 3dB 90° Couplers



967± 30MHZ DB0805A0967ASTR

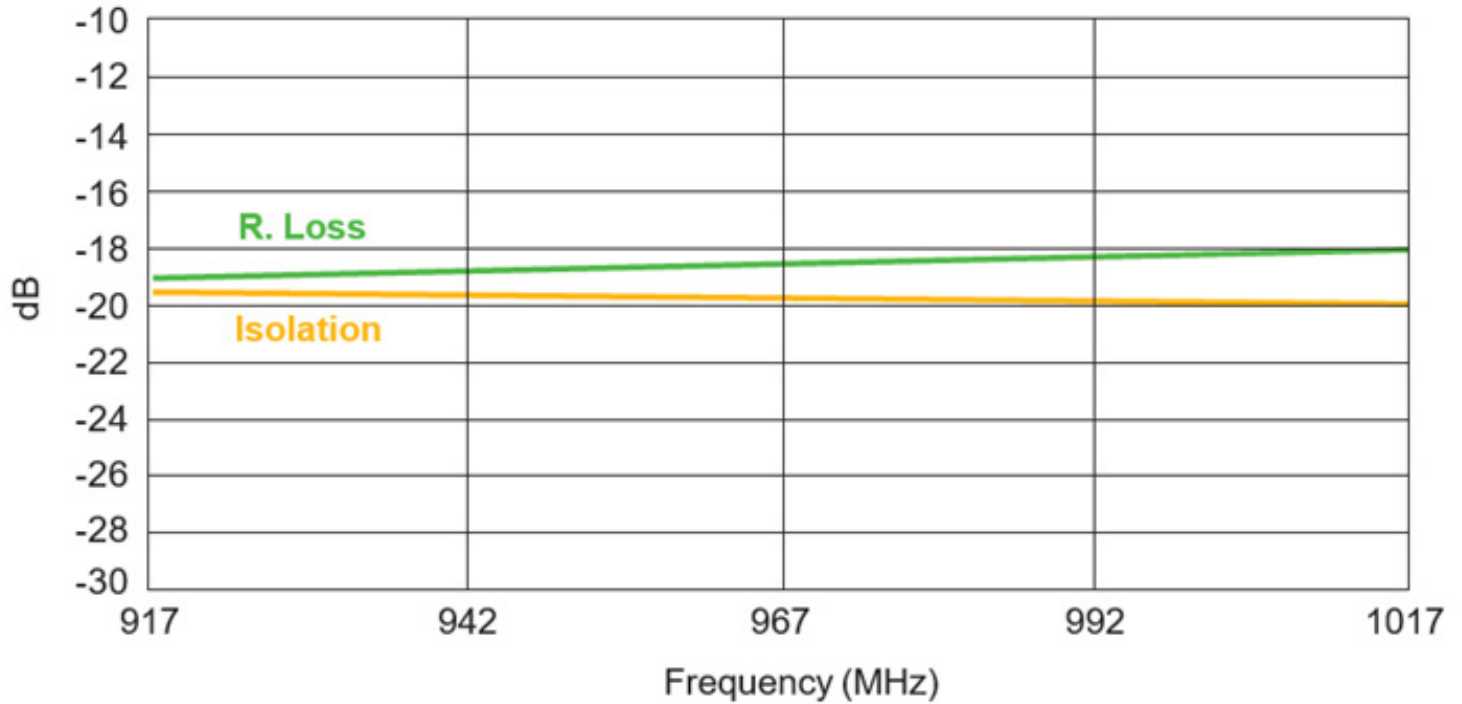
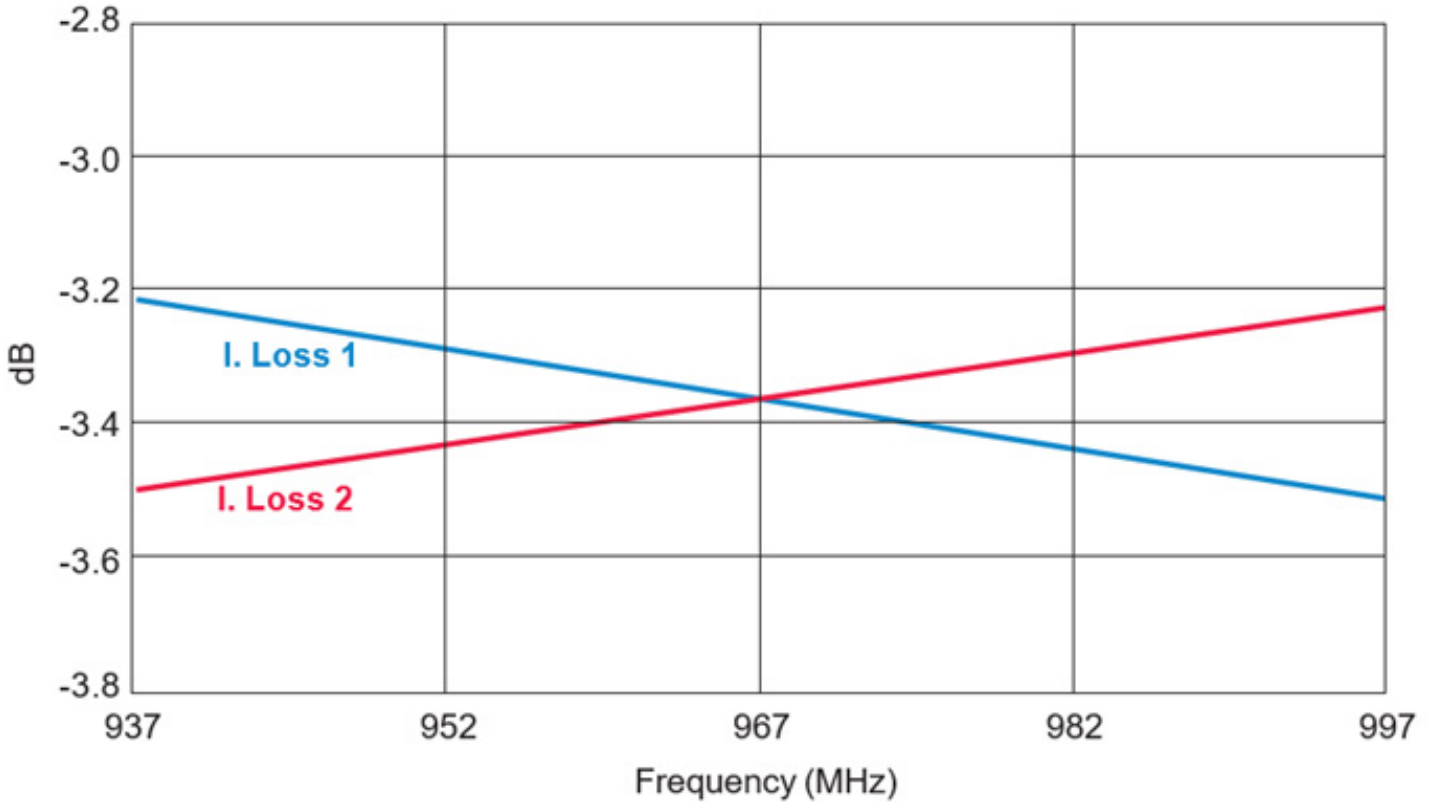

Thin-Film RF/Microwave Directional Couplers

CP0302/CP0402/CP0603/CP0805 and DB0603N/DB0805 3dB 90°

DB0805 3dB 90° Couplers



11760 ± 13MHZ DB0805A176ASTR (L1 BAND)

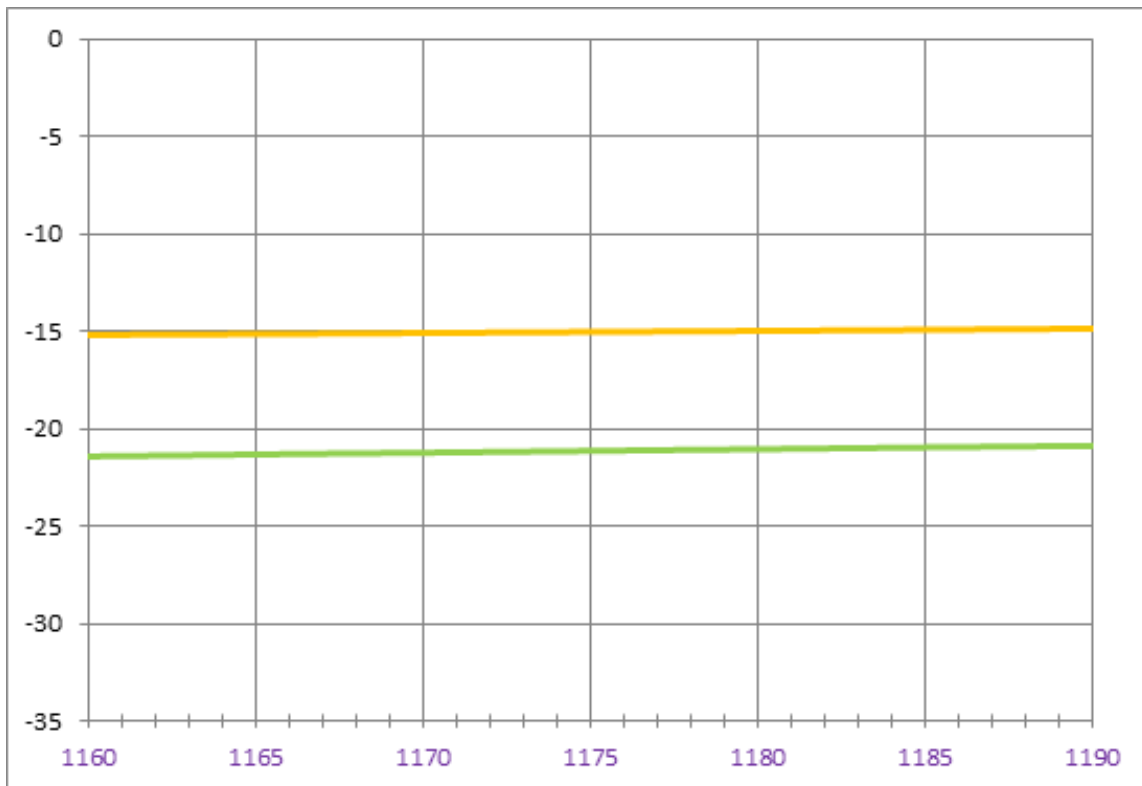
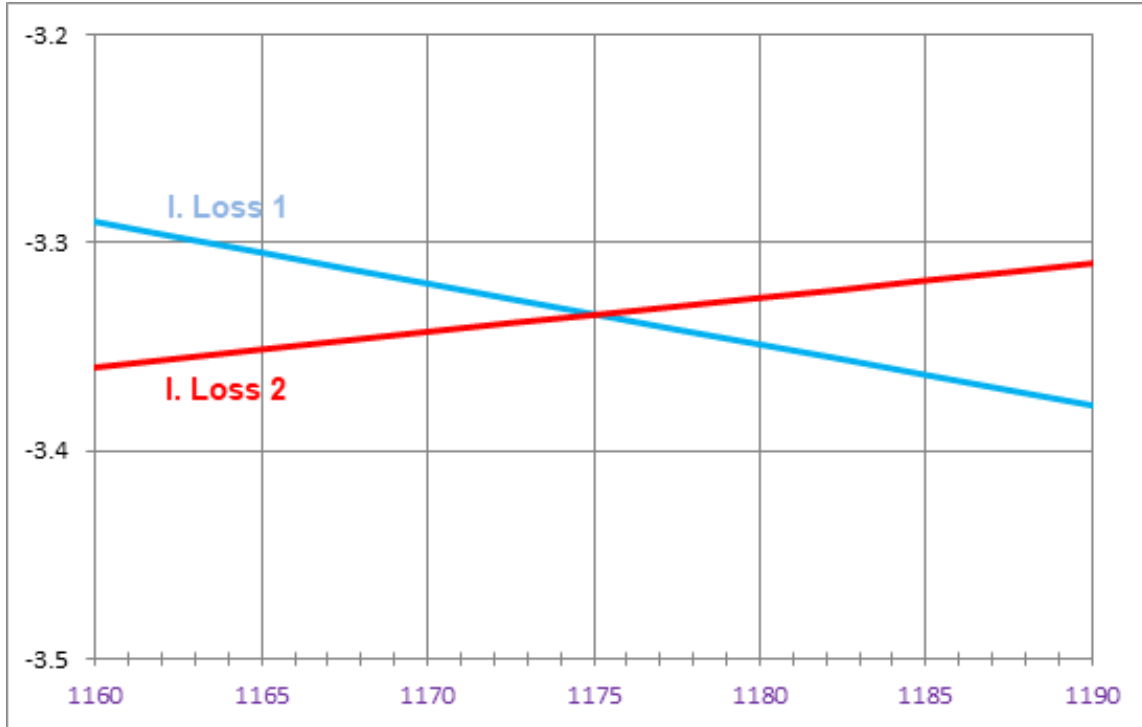

Thin-Film RF/Microwave Directional Couplers

CP0302/CP0402/CP0603/CP0805 and DB0603N/DB0805 3dB 90°

DB0805 3dB 90° Couplers



1350 ± 50MHz DB0805A1350ASTR

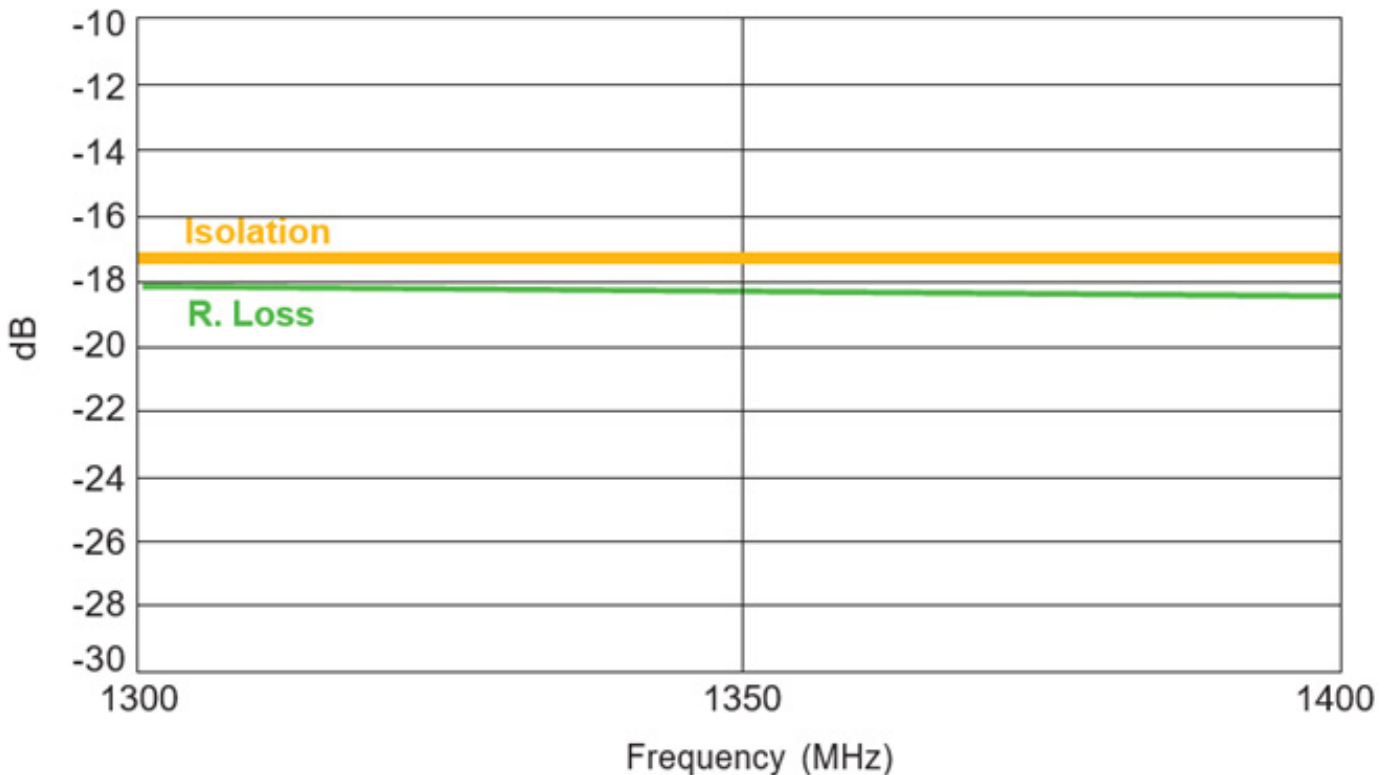
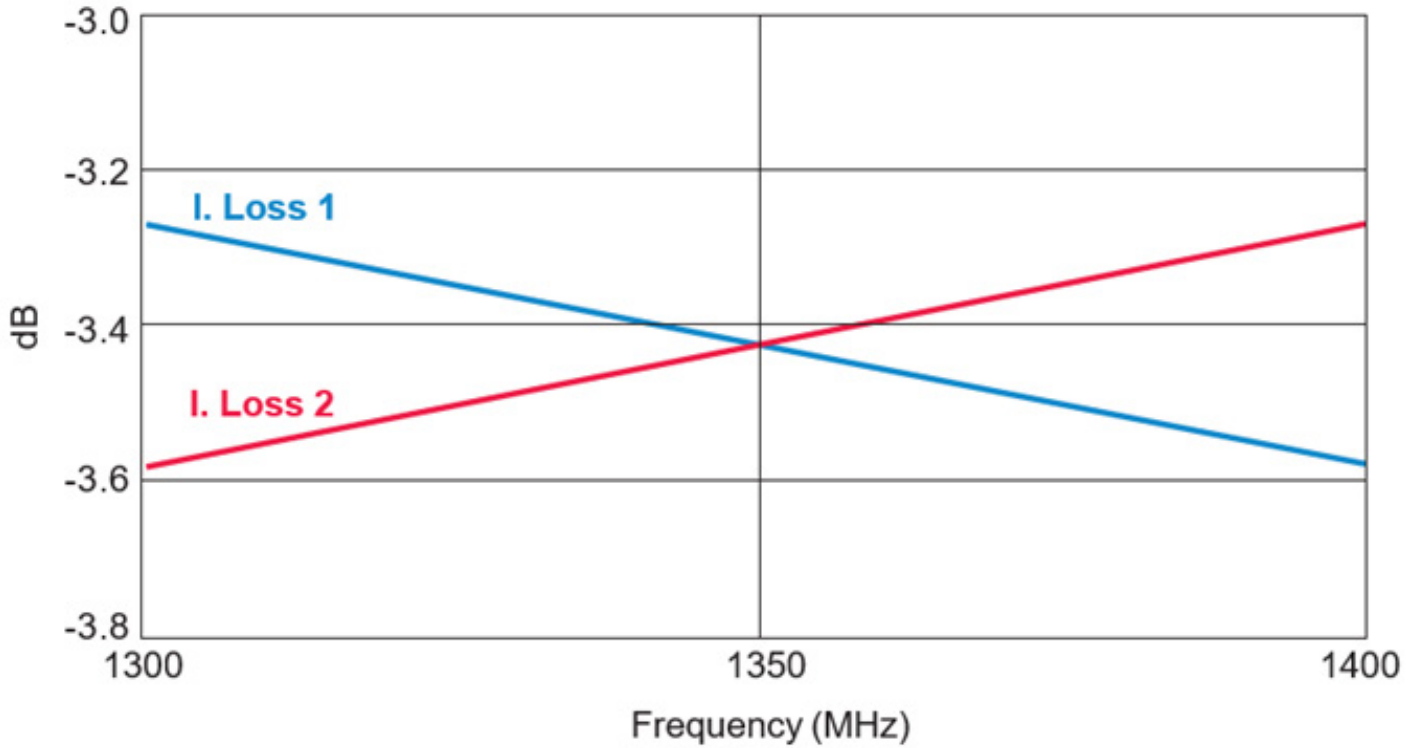

Thin-Film RF/Microwave Directional Couplers

CP0302/CP0402/CP0603/CP0805 and DB0603N/DB0805 3dB 90°

DB0805 3dB 90° Couplers



1376 ± 210 MHZ DB0805A1376ASTR (L5 BAND)

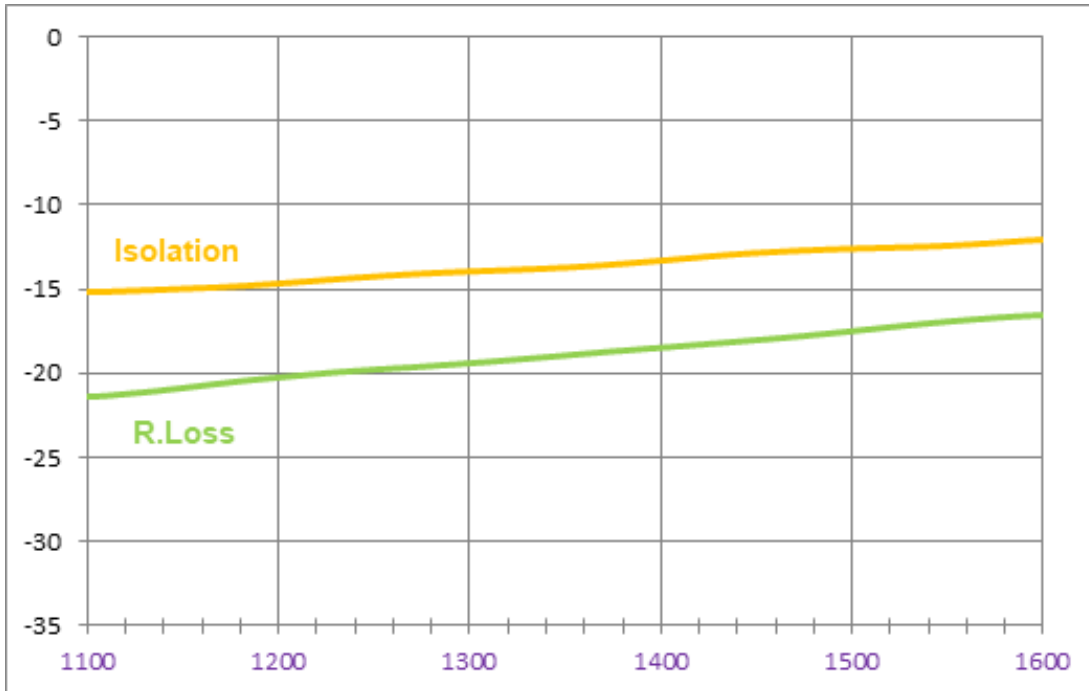
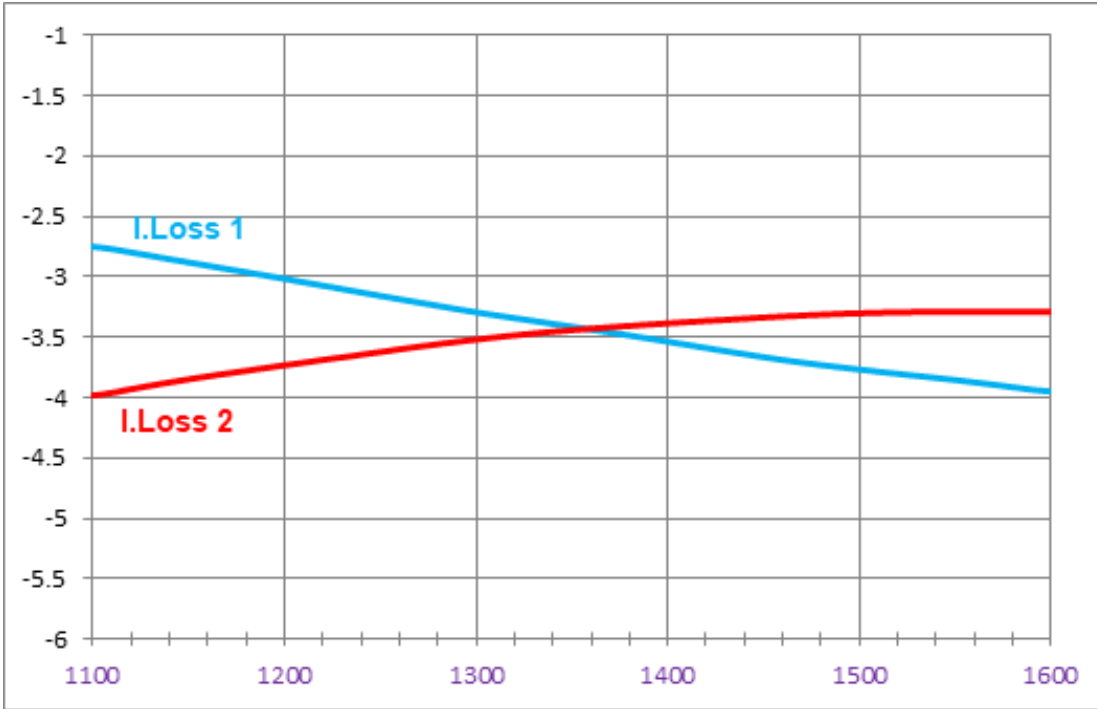

Thin-Film RF/Microwave Directional Couplers

CP0302/CP0402/CP0603/CP0805 and DB0603N/DB0805 3dB 90°

DB0805 3dB 90° Couplers



1650 ± 50MHz DB0805A1650ASTR

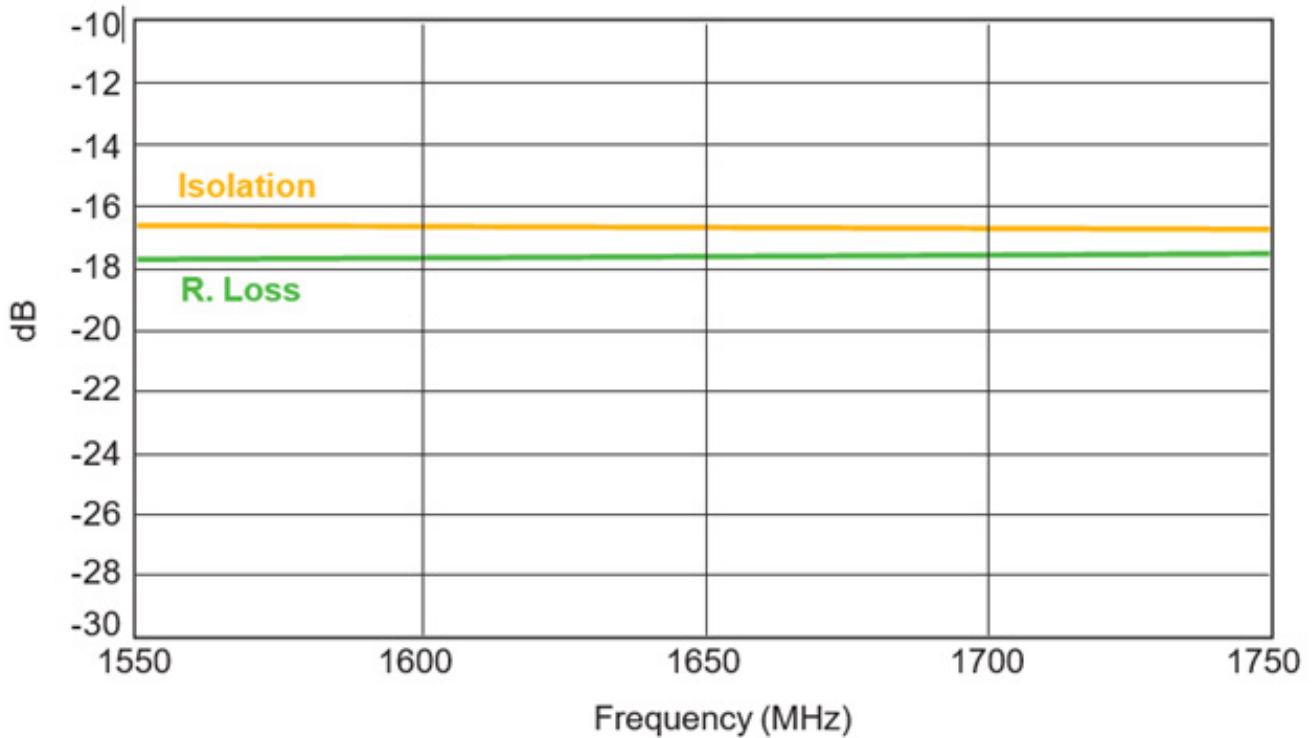
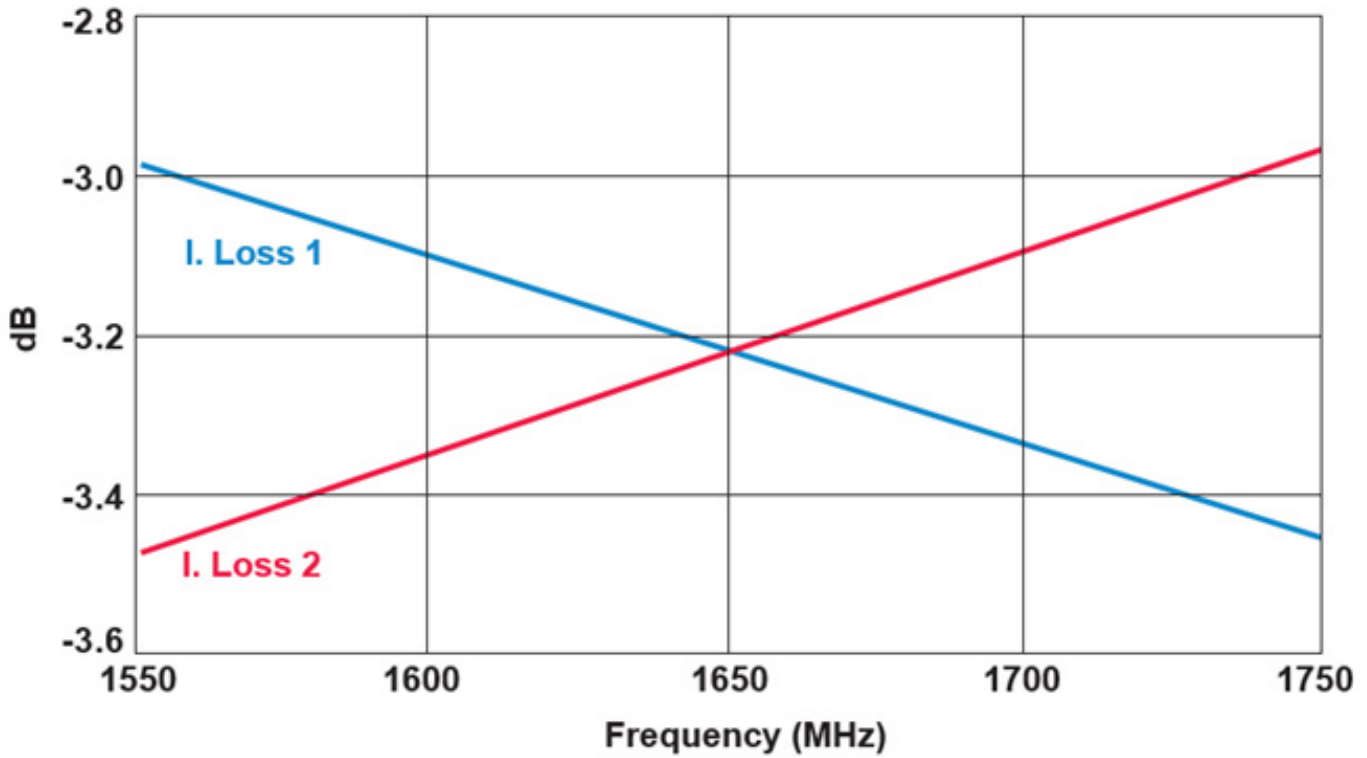

Thin-Film RF/Microwave Directional Couplers

CP0302/CP0402/CP0603/CP0805 and DB0603N/DB0805 3dB 90°

DB0805 3dB 90° Couplers



1800 ± 50MHz DB0805A1800ASTR

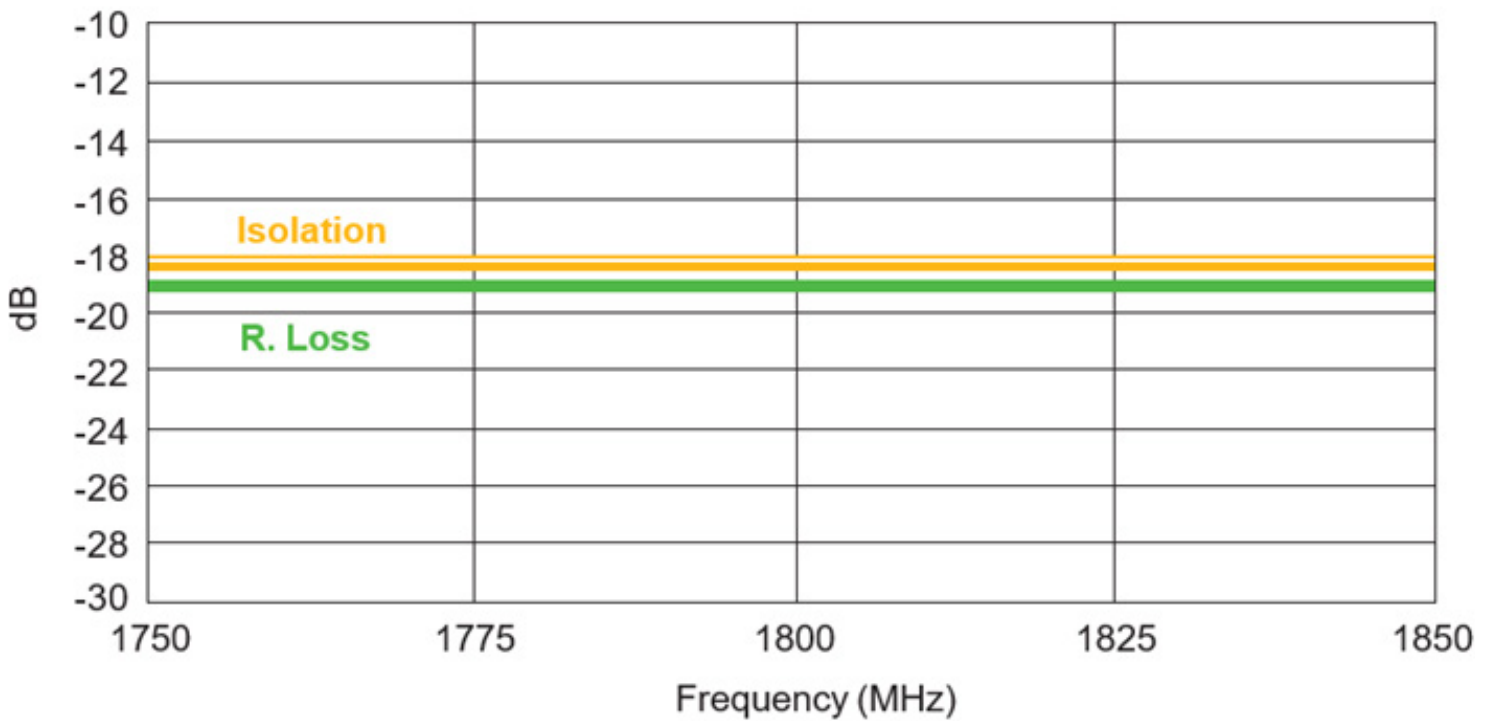
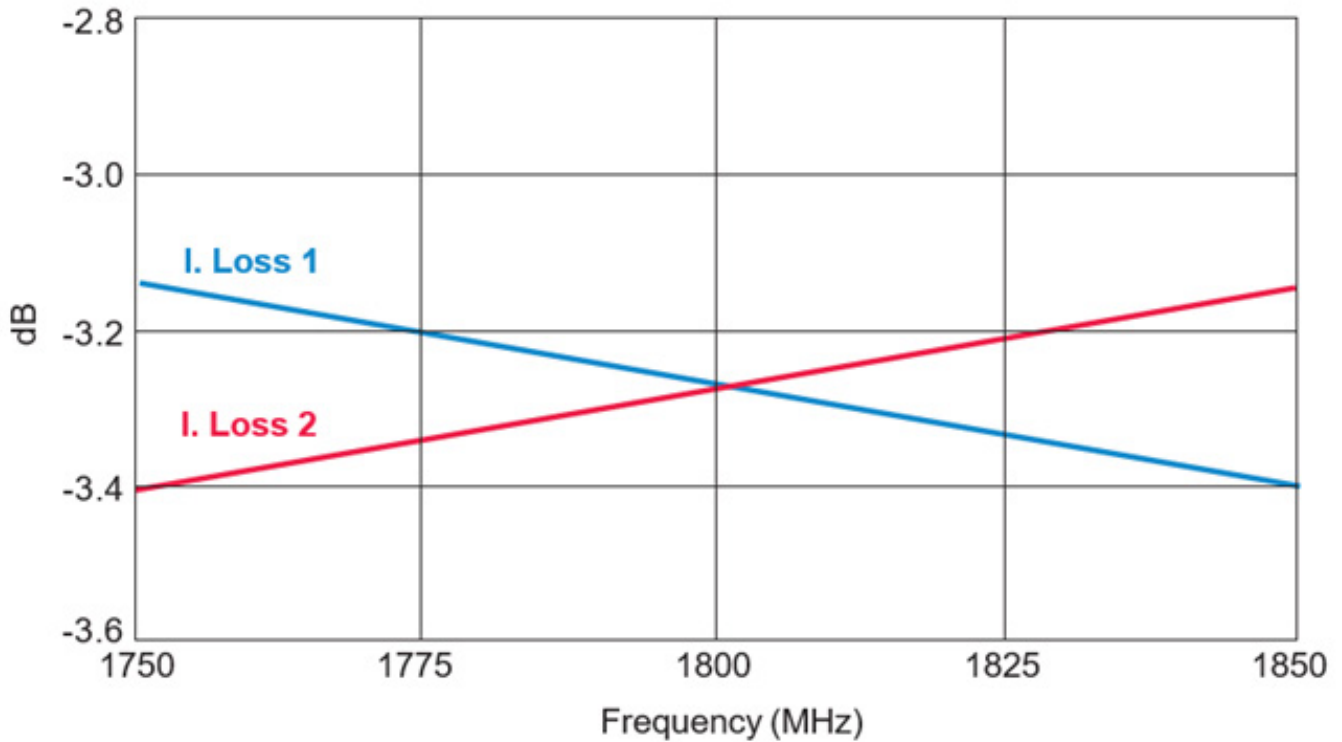

Thin-Film RF/Microwave Directional Couplers

CP0302/CP0402/CP0603/CP0805 and DB0603N/DB0805 3dB 90°

DB0805 3dB 90° Couplers



1850 ± 50MHz DB0805A1850ASTR

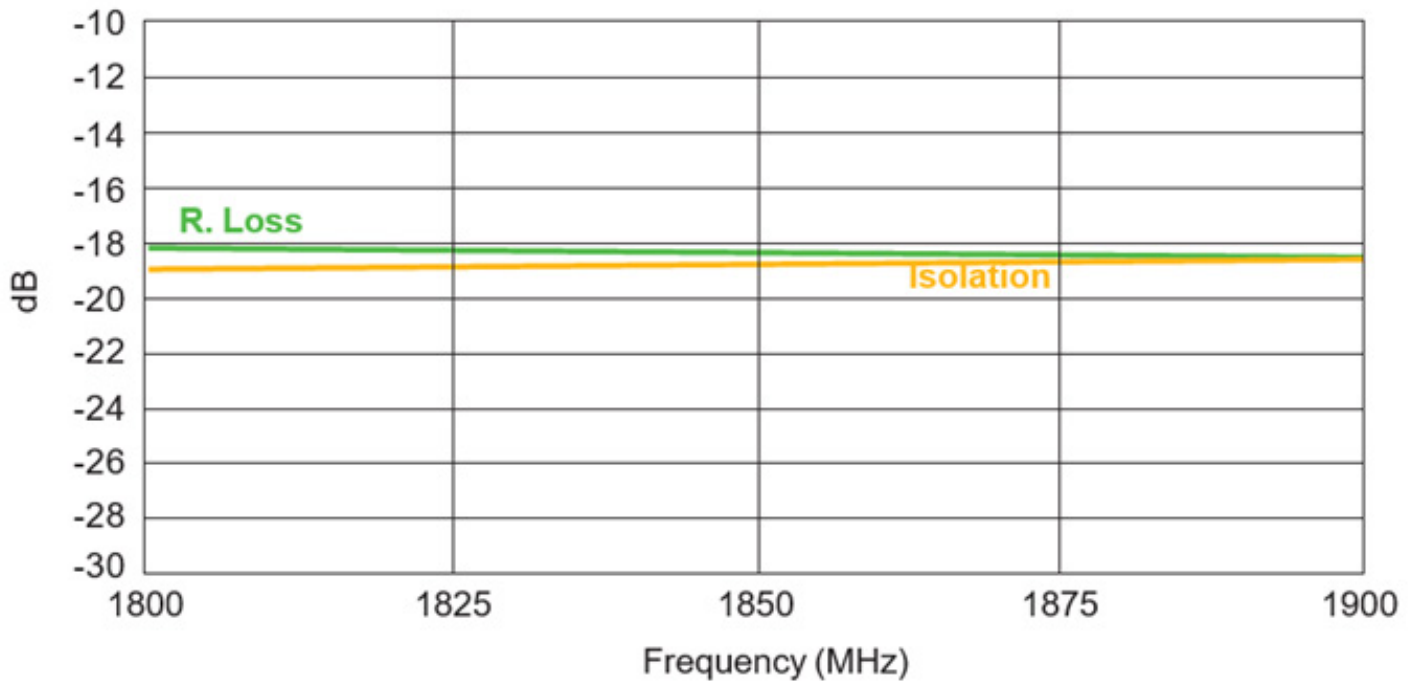
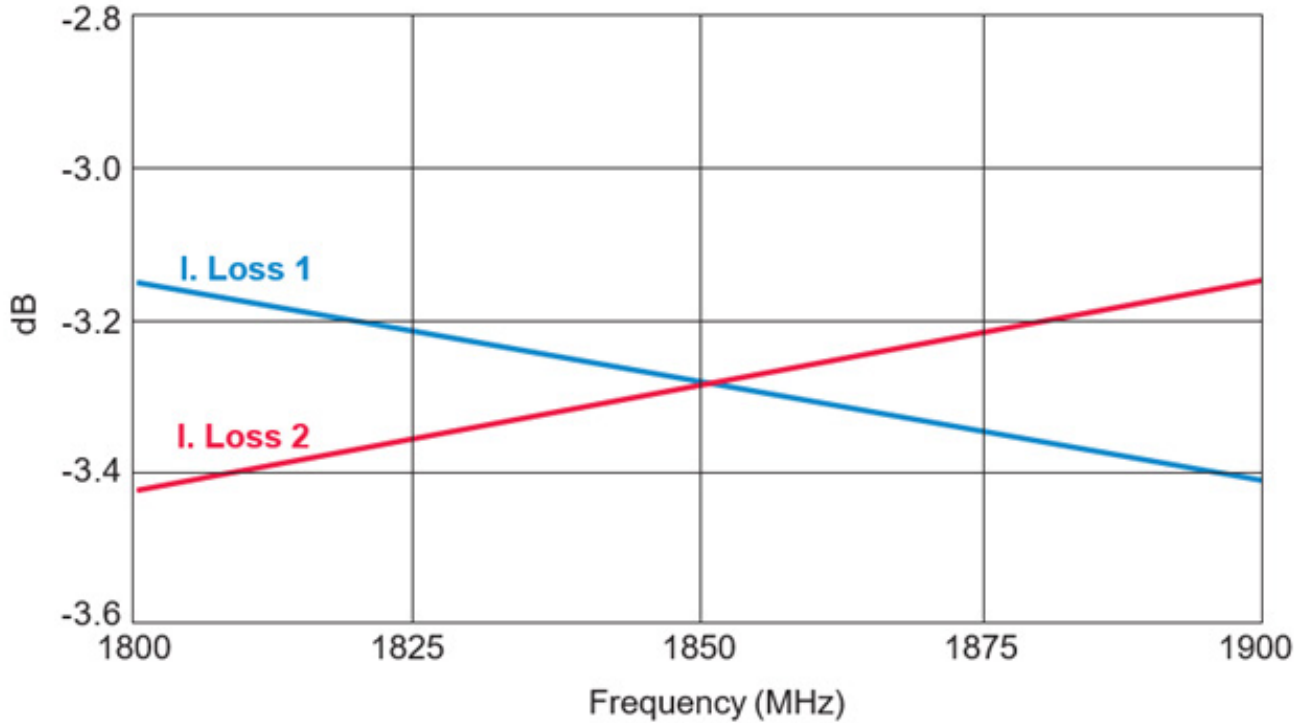

Thin-Film RF/Microwave Directional Couplers

CP0302/CP0402/CP0603/CP0805 and DB0603N/DB0805 3dB 90°

DB0805 3dB 90° Couplers



1900 ± 50MHz DB0805A1900ASTR

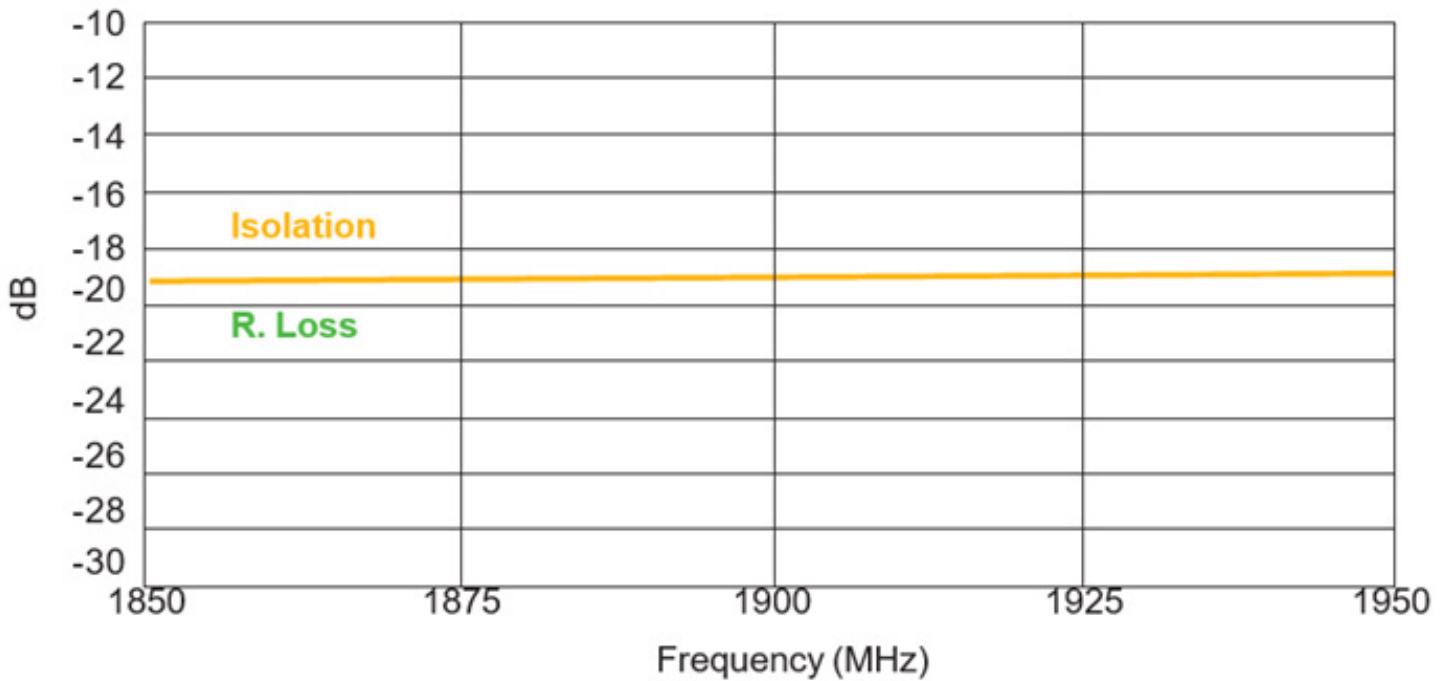
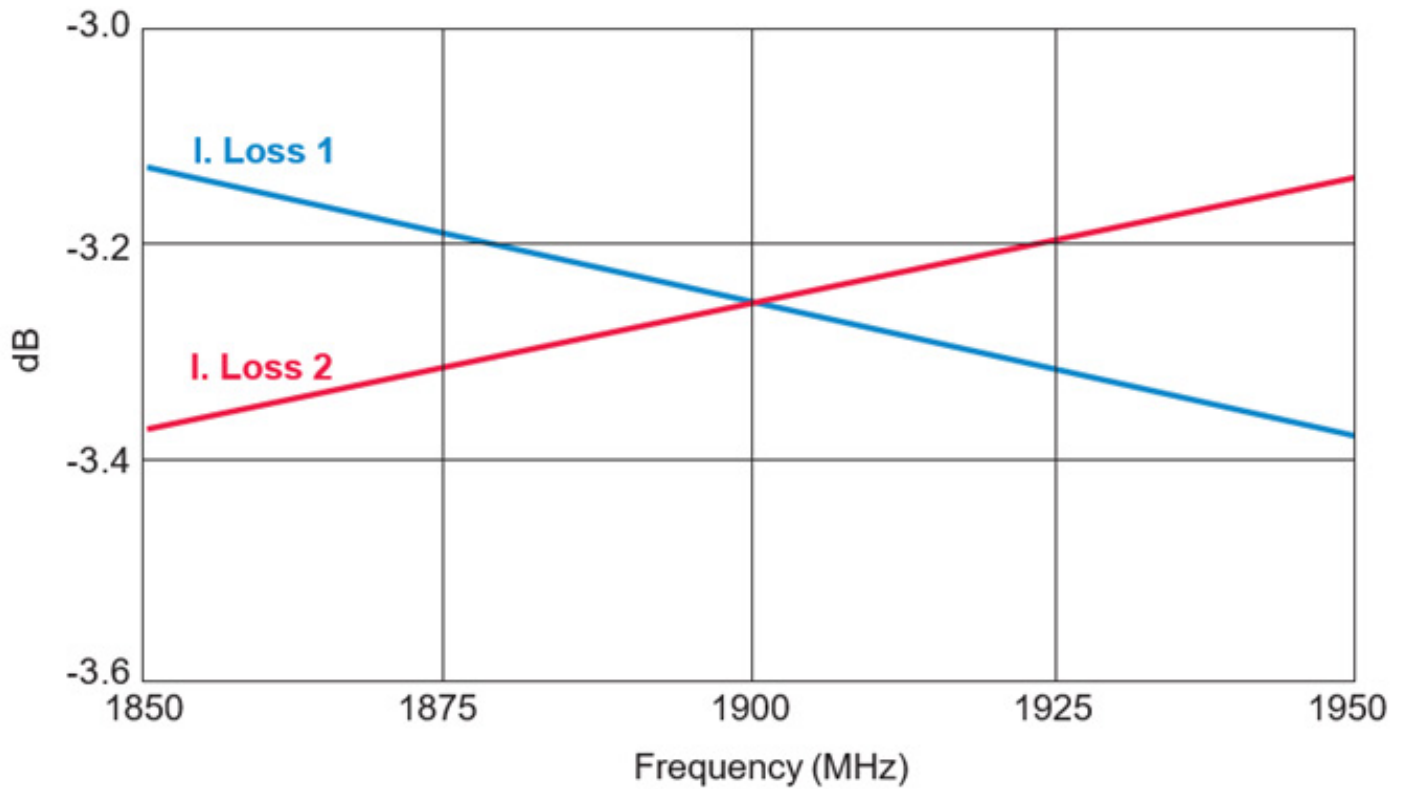

Thin-Film RF/Microwave Directional Couplers

CP0302/CP0402/CP0603/CP0805 and DB0603N/DB0805 3dB 90°

DB0805 3dB 90° Couplers



1950 ± 50MHz DB0805A1950ASTR

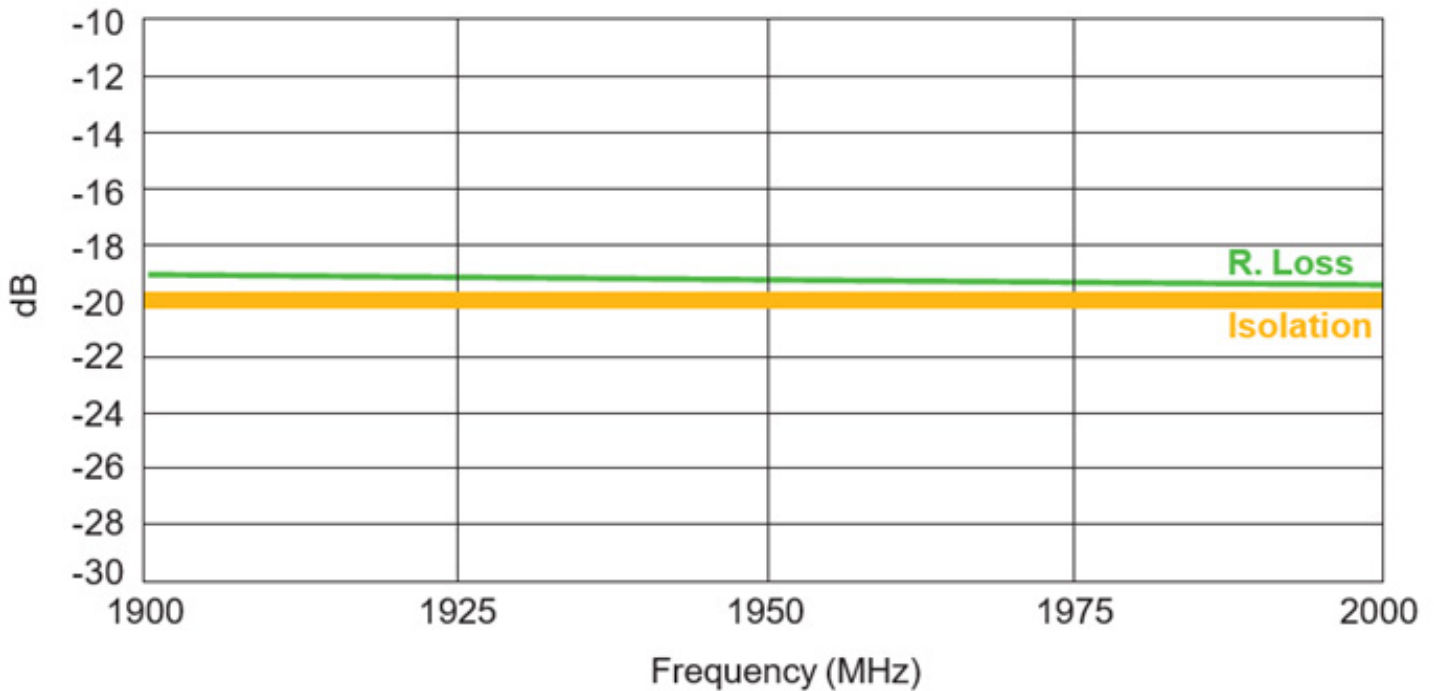
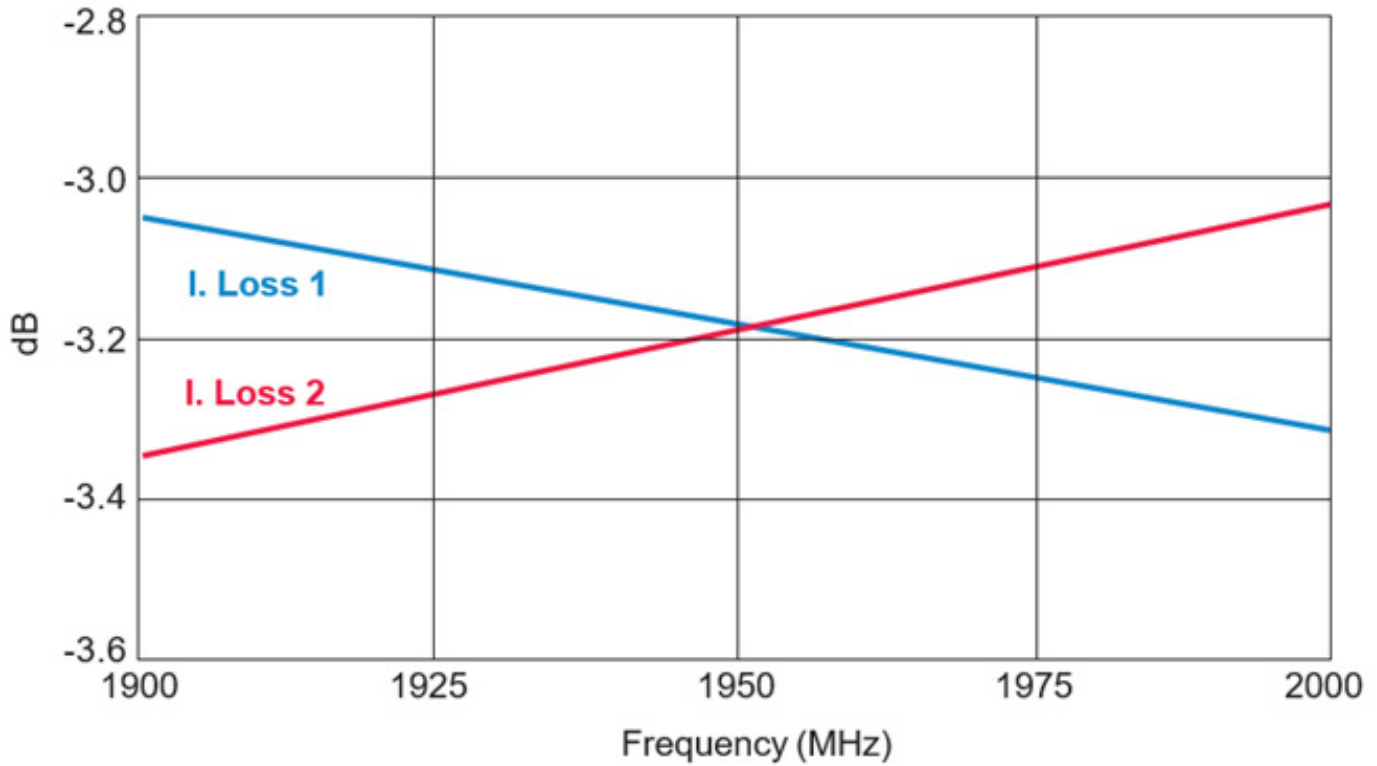

Thin-Film RF/Microwave Directional Couplers

CP0302/CP0402/CP0603/CP0805 and DB0603N/DB0805 3dB 90°

DB0805 3dB 90° Couplers



2140 ± 50MHz DB0805A2140ASTR

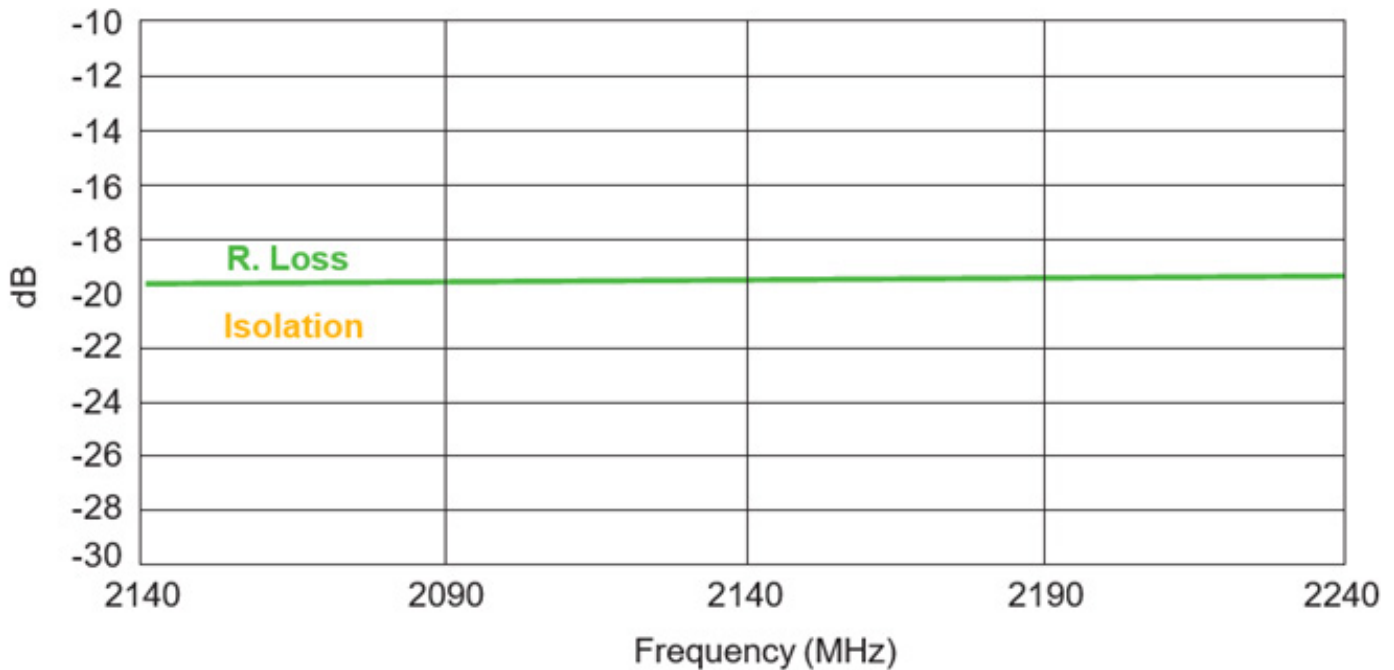
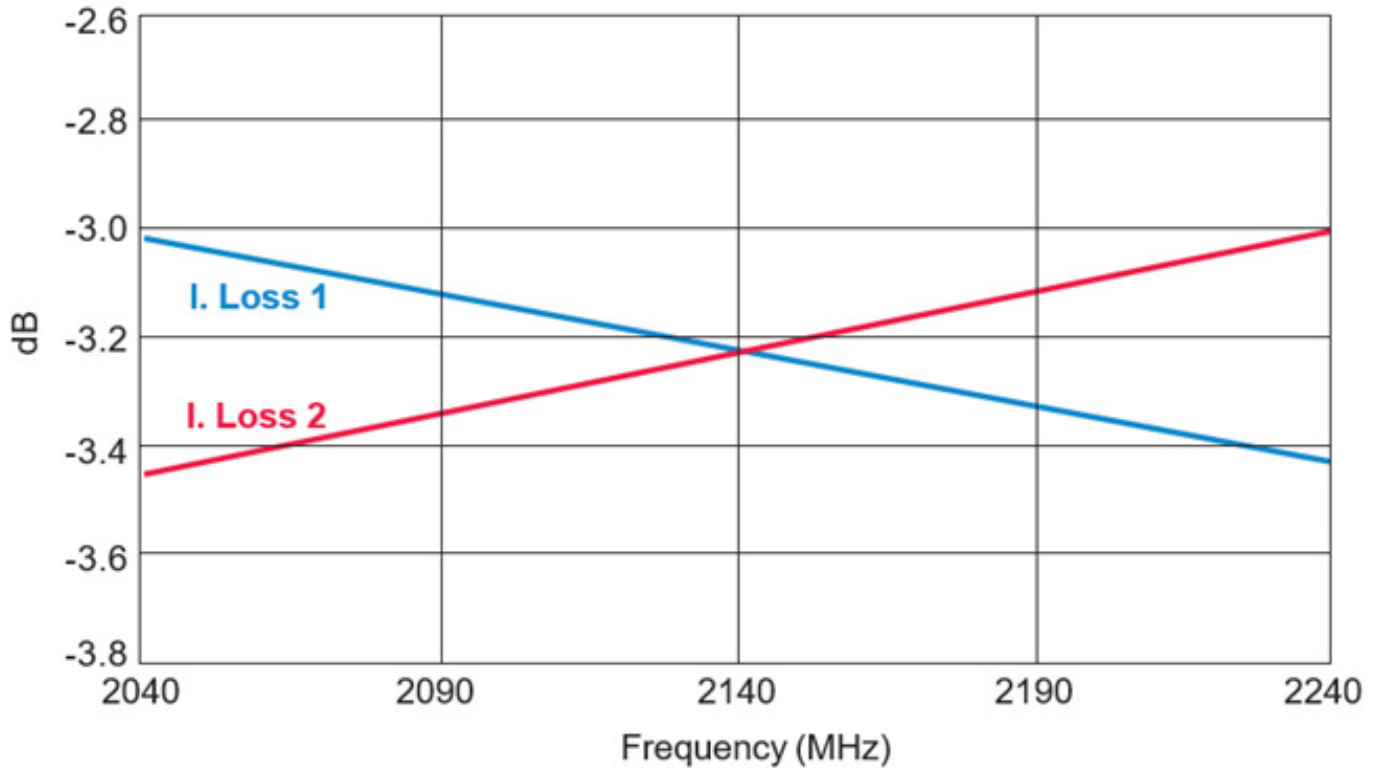

Thin-Film RF/Microwave Directional Couplers

CP0302/CP0402/CP0603/CP0805 and DB0603N/DB0805 3dB 90°

DB0805 3dB 90° Couplers



2325 ± 50MHz DB0805A2325ASTR

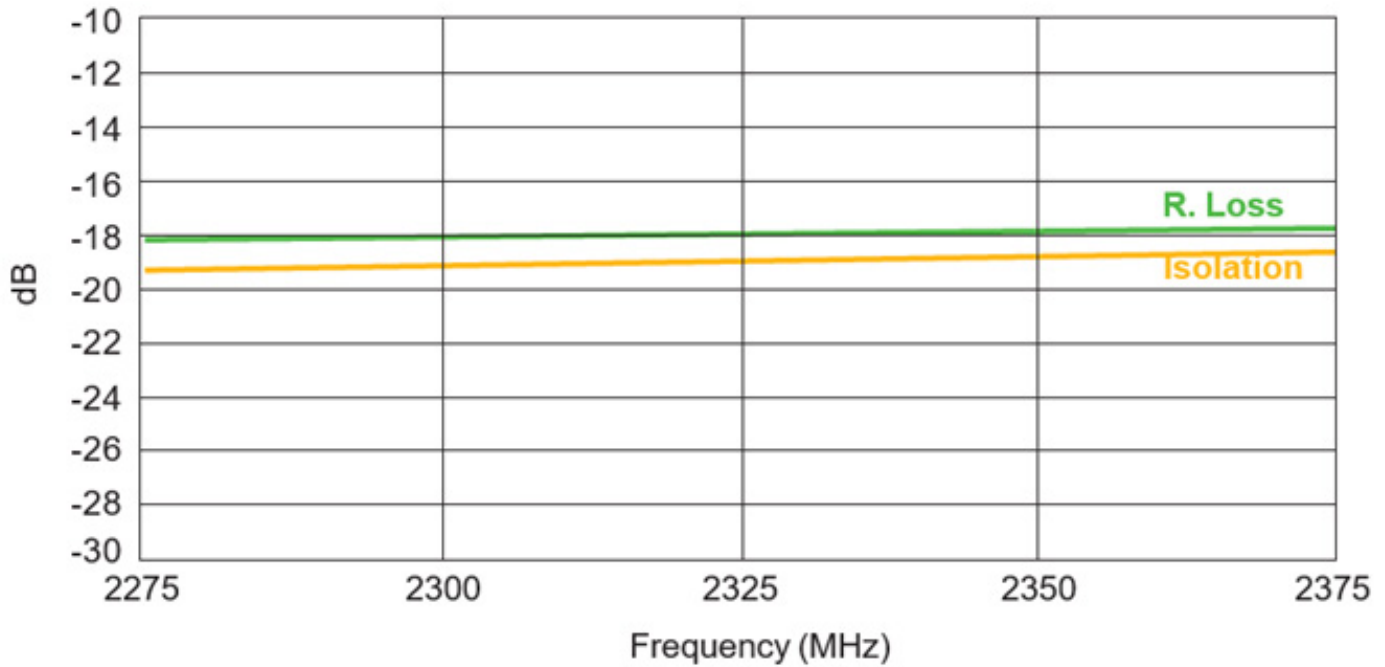
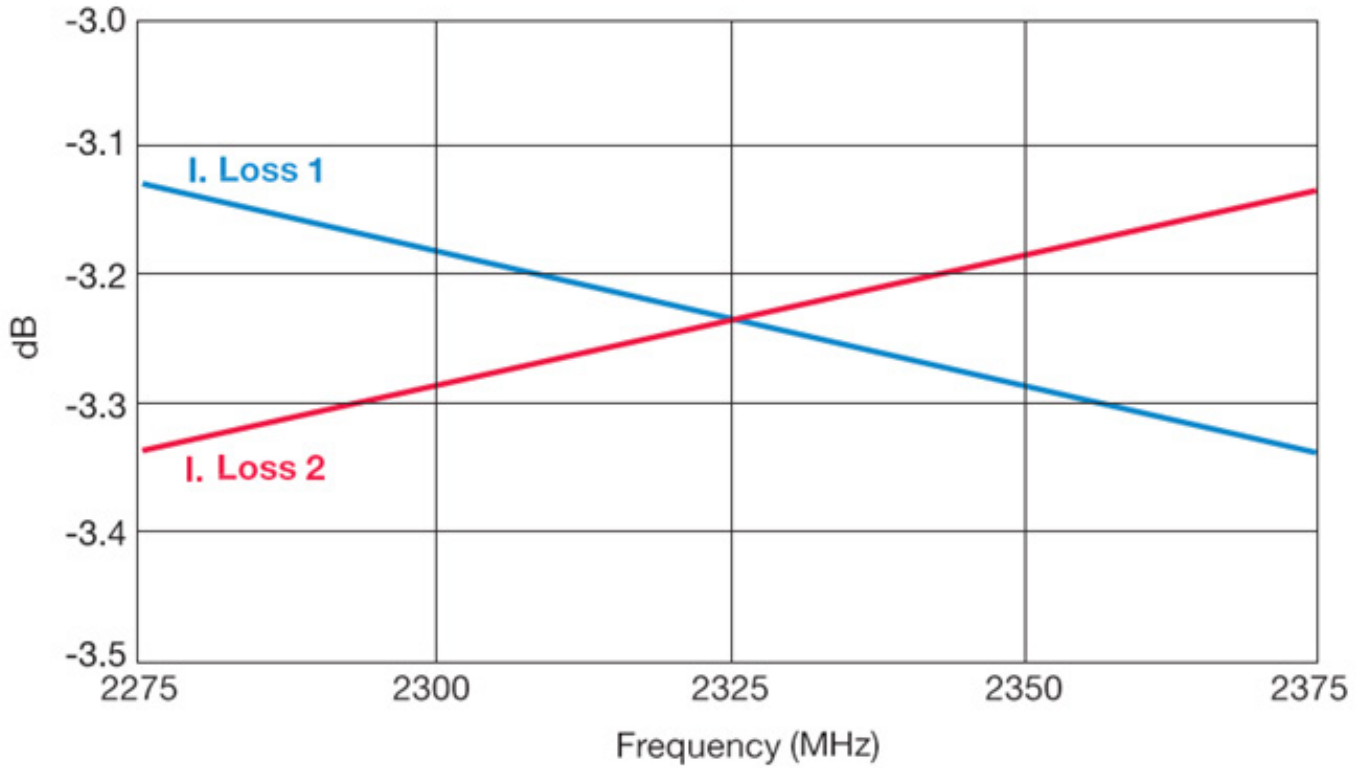

Thin-Film RF/Microwave Directional Couplers

CP0302/CP0402/CP0603/CP0805 and DB0603N/DB0805 3dB 90°

DB0805 3dB 90° Couplers

GENERAL DESCRIPTION

These jigs are designed for testing the DB0805 3dB 90° Couplers using a Vector Network Analyzer.

They consist of a dielectric substrate, having 50Ω microstrips as conducting lines and a bottom ground plane located at a distance of 0.254mm from the microstrips.

The substrate used is Neltec's NH9338ST0254C1BC.

The connectors are SMA type (female), 'Johnson Components Inc.' Product

non-metallic stick until all four ports touch the appropriate pads.

Set the VNA to the relevant frequency band. Connect the VNA using a 10dB attenuator on the jig terminal connected to port 2. Follow the VNA's instruction manual and use the [calibration jwig](#) to perform a full 2-port calibration in the required bandwidths.

P/N: 142-0701-841.

Both a measurement jig and a calibration jig are provided.

The calibration jig is designed for a full 2-port calibration, and consists of an open line, short line and through line. LOAD calibration can be done by a 50Ω SMA termination.

MEASUREMENT PROCEDURE

When measuring a component, it can be either soldered or pressed using a

Place the coupler on the [measurement jig](#) as follows:

Input (Coupler) ▶ Connector 1 (Jig)	Output 1 (Coupler) ▶ Connector 3 (Jig)
50Ω (Coupler) ▶ Connector 2 (Jig)	Output 2 (Coupler) ▶ Connector 4 (Jig)

To measure [R. Loss](#) and [I. Loss 1](#) connect:

Connector 1 (Jig) ▶ Port 1 (VNA)	Connector 3 (Jig) ▶ Port 2 (VNA)
Connector 2 (Jig) ▶ 50Ω	Connector 4 (Jig) ▶ 50Ω

To measure [R. Loss](#) and [I. Loss 2](#) connect:

Connector 1 (Jig) ▶ Port 1 (VNA)	Connector 3 (Jig) ▶ 50Ω
Connector 2 (Jig) ▶ 50Ω	Connector 4 (Jig) ▶ Port 2 (VNA)

To measure [Isolation](#) connect:

Connector 1 (Jig) ▶ 50Ω	Connector 3 (Jig) ▶ Port 1 (VNA)
Connector 2 (Jig) ▶ 50Ω	Connector 4 (Jig) ▶ Port 2 (VNA)

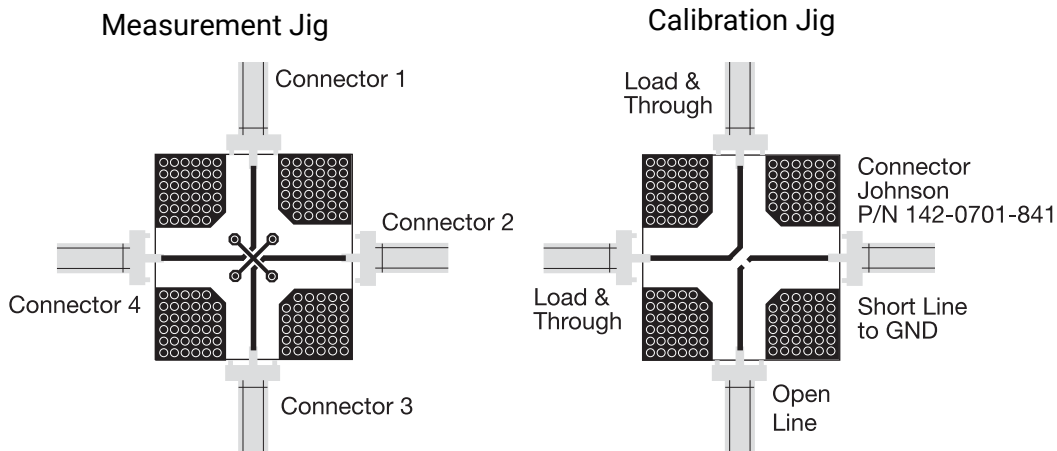

X-ON Electronics

Largest Supplier of Electrical and Electronic Components

Click to view similar products for [Signal Conditioning category](#):

Click to view products by [Kyocera AVX manufacturer](#):

Other Similar products are found below :

[MAPDCC0001](#) [MAPDCC0004](#) [PD0409J5050S2HF](#) [880157](#) [HHS-109-PIN](#) [DC1417J5005AHF](#) [AFS14A30-2185.00-T3](#) [AFS14A35-1591.50-T3](#) [DS-323-PIN](#) [B39321R801H210](#) [1A0220-3](#) [JP510S](#) [LFB212G45SG8C341](#) [LFB322G45SN1A504](#) [LFL182G45TC3B746](#) [SF2159E](#) [30057](#) [FM-104-PIN](#) [CER0813B](#) [MAPDCC0005](#) [3A325](#) [40287](#) [41180](#) [ATB3225-75032NCT](#) [BD0810N50100AHF](#) [BD2425J50200AHF](#) [C5060J5003AHF](#) [JHS-115-PIN](#) [JP503AS](#) [DC0710J5005AHF](#) [DC2327J5005AHF](#) [DC3338J5005AHF](#) [43020](#) [LFB2H2G60BB1C106](#) [LFL15869MTC1B787](#) [X3C19F1-20S](#) [XC3500P-20S](#) [10013-20](#) [SF2194E](#) [CDBLB455KCAX39-B0](#) [TGL2208-SM, EVAL](#) [RF1353C](#) [1E1305-3](#) [1F1304-3S](#) [1G1304-30](#) [B0922J7575AHF](#) [2020-6622-20](#) [10017-3](#) [TP-103-PIN](#) [BD1222J50200AHF](#)