

Safety Capacitors, KGK and KGH Series

General Specifications

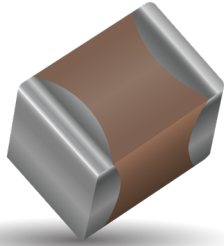

GENERAL DESCRIPTION

Safety Certified Capacitors are designed for surge or lightning immunity in modem facsimile and other equipment. The capacitors of KGK are class X1/Y2 compliant, and the capacitors of KGH are class X2 compliant, respectively.

The green type capacitors in KGK/KGH are manufactured by using environmentally friendly materials without lead or cadmium.

The terminations are composed of plated nickel and pure tin to feature the superior leaching resistance during soldering.

CERTIFICATE NUMBER:

R50545773 by TUV.

E467744 (FOWX2/8) by UL.

FEATURES

- High Reliability and Stability
- Small Size and High Capacitance
- RoHS Compliant
- Safety standard approval by:
 - EN 60384-14: 2013
 - IEC 60384-14 : 2013
 - UL 60384-14 (Ed 2.0)
- HALOGEN Compliant

APPLICATIONS

- Modem
- Facsimile
- Telephone
- Other electronic equipment for lighting or surge protection and isolation

HOW TO ORDER

KGK	42	G	CG	3H	3R0	C	Y	T
Series	Size	Thickness	Dielectric	Impulse Voltage	Capacitance Code Code (in pF)	Capacitance Tolerance	Packaging	Optional Code
KGK = X1/Y2 KGH = X2	42 = 1808 43 = 1812 58 = 2211 55 = 2220	See Cap Chart	CG = C0G R7 = X7R	3E = 2.5kV 3H = 5.0kV 3L = 6.0kV	2 Significant Digits +Number of zeros eg. 10µF = 106 10nF = 103 47pF = 470	C = ±0.25pF D = ±0.50pF J = ±5% K = ±10%	See Table Below	Blank = Standard Safety Capacitor 1A = Flexiterm 2A = Anti Arcing with Flexiterm 2B = Anti Arcing

RoHS COMPLIANT

PACKAGING CODES

Code	EIA (inch)	IEC(mm)	7" Embossed	13" Embossed
42	1808	4520	Y	K
43	1812	4532	V	S
58	2211	5728	V	S
55	2220	5720	V	S

Safety Capacitors, KGK and KGH Series

General Specifications

GENERAL ELECTRICAL DATA

Dielectric	COG		X7R
Size	1808, 1812, 2211		1808, 1812, 2211, 2220
Rated Voltage	250Vac		
Capacitance Range	X1/Y2 Class (Impulse 6KV) : 4pF ~ 100pF X1/Y2 Class (Impulse 5KV) : 3pF ~ 720pF X2 Class : 3pF ~ 1000pF		X1/Y2 Class : 100pF ~ 4700pF X2 Class: 150pF~56000pF
Capacitance Tolerance	Cap. Range		J (±5%) K (±10%) M (±20%)
	Tolerance Spec.		
	C < 10pF	A (±0.05pF), B (±0.1pF), C (±0.25pF), D (±0.5pF)	
Tan δ	Cap. Range		≤2.5%
	Q Spec.		
	C < 30pF	Q ≥ 400 + 20C	
	C ≥ 30pF	Q ≥ 1000	
Capacitance & Tan δ Test Condition	Measured at: 30 ~ 70% Related Humidity		
	For 25°C at ambient temperature		Preconditioning for Class II MLCC: Perform a heat treatment at 150±10°C for 1 hour, then leave in ambient condition for 24±2 hours before measurement
	Cap. Range		1.0 ± 0.2V _{rms} , 1.0KHz ± 10%, at 25°C ambient temperature
	Frequency		
Cap. ≤ 1000pF	1.0±0.2Vrms, 1.0MHz±10%		
Cap. > 1000pF	1.0±0.2Vrms, 1.0KHz±10%		
Insulation Resistance	≥100GΩ or RxC ≥ 1000Ω-F(Smaller Option)		≥10GΩ or RxC ≥ 500Ω-F(Smaller Option)
Operating Temperature	-55°C to +125°C		
Temperature Coefficient	±30ppm /°C		±15%
Termination	Cu or Ag/Ni/Sn (lead-free termination)		

Safety Capacitors, KGK Series

Capacitance Range (X1/Y2 NP0)

SIZES AND CAPACITANCE RANGE

SIZE		1808		1812		2211	
(L) Length	mm	4.5	+0.60 -0.30	4.5	+0.60 -0.30	5.7	±0.50
	(in.)	0.177	+0.024 -0.012	0.177	+0.024 -0.012	0.224	±0.02
(W) Width	mm	2.00±0.30		3.20±0.40		2.80±0.40	
	(in.)	(0.079±0.012)		(0.126±0.016)		(0.110±0.016)	
(t) Terminal	mm	0.50±0.25		0.50±0.25		0.60±0.30	
	(in.)	(0.02±0.01)		(0.02±0.01)		(0.024±0.012)	
Certification		IEC60384-14					
Rated Voltage		250V _{ac}					
Impulse		5kV		5kV		5kV 6kV	
Cap	Code						
3.0 (pF)	3R0	G					
3.3	3R3	G					
3.9	3R9	G					
4.0	4R0	G			F	F	
4.7	4R7	G			F	F	
5.0	5R0	G			F	F	
5.6	5R6	G			F	F	
6.0	6R0	G			F	F	
6.8	6R8	G			F	F	
7.0	7R0	G			F	F	
8.0	8R0	G			F	F	
8.2	8R2	G			F	F	
9.0	9R0	G					
10	100	G		N	F	F	
12	120	G		N	F	F	
15	150	G		N	F	F	
18	180	G		N	F	F	
22	220	G		N	F	F	
27	270	G		N	F	F	
33	330	G		N	F	F	
39	390	B		N	F	F	
47	470	B		N	F	F	
56	560	B		N	F	F	
68	680	B		N	F	C	
82	820	B		N	F	C	
100	101	H		N	F	G	
120	121	H		N	C		
130	131	H		N			
150	151	H		N	C		
160	161	H		N	C		

SIZE		1808		1812		2211	
(L) Length	mm	4.5	+0.60 -0.30	4.5	+0.60 -0.30	5.7	±0.50
	(in.)	0.177	+0.024 -0.012	0.177	+0.024 -0.012	0.224	±0.02
(W) Width	mm	2.00±0.30		3.20±0.40		2.80±0.40	
	(in.)	(0.079±0.012)		(0.126±0.016)		(0.110±0.016)	
(t) Terminal	mm	0.50±0.25		0.50±0.25		0.60±0.30	
	(in.)	(0.02±0.01)		(0.02±0.01)		(0.024±0.012)	
Certification		IEC60384-14					
Rated Voltage		250V _{ac}					
Impulse		5kV		5kV		5kV 6kV	
180	181	H		N		C	
220	221	H		Q		C	
270	271	H		Q		C	
300	301			Q			
330	331			Q		C	
390	391			Q		C	
470	471			Q		C	
560	561					C	
680	681					C	

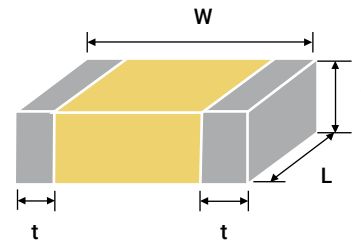

PHYSICAL DIMENSIONS

Size	L		W		t	
	mm	(in.)	mm	(in.)	mm	(in.)
1808	+0.60 -0.30	+0.024 -0.012	2.00±0.30	(0.079±0.012)	0.50±0.25	(0.02±0.01)
1812	+0.60 -0.30	+0.024 -0.012	3.20±0.40	(0.126±0.016)	0.50±0.25	(0.02±0.01)
2211	±0.50	±0.02	2.80±0.40	(0.110±0.016)	0.60±0.30	(0.024±0.012)

Case Size	1808 (KGK42)			1812 (KGK43)		2211 (KGK 58)		
Thickness Letter	G	B	H	N	Q	F	C	G
Max Thickness (mm)	1.55	1.80	2.20	1.35	2.20	2.20	2.80	3.10
Carrier Tape	EMB			EMB		EMB		
Packaging Code 7" reel	Y	Y	Y	V	V	V	V	V
Packaging Code 13" reel	K	K	K	S	S	S	S	S
Embossed(EMB)								

Safety Capacitors, KGK Series

Capacitance Range (X1/Y2 X7R)

SIZES AND CAPACITANCE RANGE

SIZE		1808		1812		2211		2220	
(L) Length	mm	4.5	+0.60-0.30	4.5	+0.60-0.30	5.7	±0.50	5.7	±0.50
	(in.)	0.177	+0.024-0.012	0.177	+0.024-0.012	0.224	±0.02	0.224	±0.02
(W) Width	mm	2.00±0.30		3.20±0.40		2.80±0.40		5.00±0.50	
	(in.)	(0.079±0.012)		(0.126±0.016)		(0.110±0.016)		(0.197±0.02)	
(t) Terminal	mm	0.50±0.25		0.50±0.25		0.60±0.30		0.60±0.30	
	(in.)	(0.02±0.01)		(0.02±0.01)		(0.024±0.012)		0.024±0.012	
Certification		IEC60384-14							
Rated Voltage		250V _{ac}							
Impulse		5kV		5kV		5kV		5kV	
Cap	Code								
3.0 (pF)	3R0								
3.3	3R3								
3.9	3R9								
4.0	4R0								
4.7	4R7								
5.0	5R0								
5.6	5R6								
6.0	6R0								
6.8	6R8								
7.0	7R0								
8.0	8R0								
8.2	8R2								
9.0	9R0								
10	100								
12	120								
15	150								
18	180								
22	220								
27	270								
33	330								
39	390								
47	470								
56	560								
68	680								
82	820								
100	101	B				E			
120	121	B*				E*			
130	131					E*			
150	151	B*		E*		E*			
160	161	B*						F*	
180	181	B*		E*		E*		F*	
220	221	B*		E*		E*		F*	

SIZE		1808		1812		2211		2220	
(L) Length	mm	4.5	+0.60-0.30	4.5	+0.60-0.30	5.7	±0.50	5.7	±0.50
	(in.)	0.177	+0.024-0.012	0.177	+0.024-0.012	0.224	±0.02	0.224	±0.02
(W) Width	mm	2.00±0.30		3.20±0.40		2.80±0.40		5.00±0.50	
	(in.)	(0.079±0.012)		(0.126±0.016)		(0.110±0.016)		(0.197±0.02)	
(t) Terminal	mm	0.50±0.25		0.50±0.25		0.60±0.30		0.60±0.30	
	(in.)	(0.02±0.01)		(0.02±0.01)		(0.024±0.012)		0.024±0.012	
Certification		IEC60384-14							
Rated Voltage		250V _{ac}							
Impulse		5kV		5kV		5kV		5kV	
Cap	Code								
270	271	H*		E*		E*		F*	
300	301								
330	331	H*		E*		E*		F*	
390	391	H*		E*		E*		F*	
470	471	H*		E*		F*		F*	
560	561	H*		E*		F*		F*	
680	681	H*		Q*		F*		F*	
720	721							F*	
820	821	H*		Q*		F*		F*	
1000	102	H*		J*		C*		F*	
1200	122					C*		C*	
1500	152					C*		C*	
1800	182					C*		C*	
2200	222					C*		C*	
2700	272					G*		C*	
3300	332							C*	
3900	392							C*	
4700	472							C*	
5600	562								
10 (nF)	103								
12	123								
15	153								
18	183								
22	223								
27	273								
33	333								
39	393								
47	473								
56	563								

*anti-arcing only

Case Size	1808 (KGK42)			1812 (KGK43)			2211 (KGK 58)			2220 (KGK 55)	
Thickness Letter	G	B	H	E	Q	J	F	C	G	F	C
Max Thickness (mm)	1.55	1.80	2.20	1.80	2.20	2.80	2.20	2.80	3.10	2.20	2.80
Carrier Tape	EMB			EMB			EMB			EMB	
Packaging Code 7"reel	Y	Y	Y	V	V	V	V	V	V	V	V
Packaging Code 13"reel	K	K	K	S	S	S	S	S	S	S	S
Embossed(EMB)											

Safety Capacitors, KGH Series

Capacitance Range (X2 NP0)

SIZES AND CAPACITANCE RANGE

SIZE		1808				1812					
(L) Length	mm	4.5	+0.60-0.30	4.5	+0.60-0.30	(L) Length	mm	4.5	+0.60-0.30	4.5	+0.60-0.30
	(in.)	0.177	+0.024-0.012	0.177	+0.024-0.012		(in.)	0.177	+0.024-0.012	0.177	+0.024-0.012
(W) Width	mm	2.00±0.30		3.20±0.40		(W) Width	mm	2.00±0.30		3.20±0.40	
	(in.)	(0.079±0.012)		(0.126±0.016)			(in.)	(0.079±0.012)		(0.126±0.016)	
(t) Terminal	mm	0.50±0.25		0.50±0.25		(t) Terminal	mm	0.50±0.25		0.50±0.25	
	(in.)	(0.02±0.01)		(0.02±0.01)			(in.)	(0.02±0.01)		(0.02±0.01)	
Certification		IEC60384-14									
Rated Voltage		250V _{ac}									
Impulse		2.5kV				2.5kV					
Cap	Code										
3.0 (pF)	3R0	G									
3.3	3R3										
3.9	3R9										
4.0	4R0	G									
4.7	4R7										
5.0	5R0	G									
5.6	5R6										
6.0	6R0	G									
6.8	6R8										
7.0	7R0	G									
8.0	8R0	G									
8.2	8R2										
9.0	9R0	G									
10	100	G				N					
12	120	G				N					
15	150	G				N					
18	180	G									
22	220	G				N					
27	270	G				N					
33	330	G				N					
39	390	B				N					
47	470	B				N					
56	560	B				N					
68	680	B				N					
82	820	B				N					
100	101	H				N					
120	121	H				N					
130	131										
150	151	H				N					
160	161										

SIZE		1808				1812					
(L) Length	mm	4.5	+0.60-0.30	4.5	+0.60-0.30	(L) Length	mm	4.5	+0.60-0.30	4.5	+0.60-0.30
	(in.)	0.177	+0.024-0.012	0.177	+0.024-0.012		(in.)	0.177	+0.024-0.012	0.177	+0.024-0.012
(W) Width	mm	2.00±0.30		3.20±0.40		(W) Width	mm	2.00±0.30		3.20±0.40	
	(in.)	(0.079±0.012)		(0.126±0.016)			(in.)	(0.079±0.012)		(0.126±0.016)	
(t) Terminal	mm	0.50±0.25		0.50±0.25		(t) Terminal	mm	0.50±0.25		0.50±0.25	
	(in.)	(0.02±0.01)		(0.02±0.01)			(in.)	(0.02±0.01)		(0.02±0.01)	
Certification		IEC60384-14									
Rated Voltage		250V _{ac}									
Impulse		2.5kV				2.5kV					
180	181	H				N					
220	221	H				N					
270	271	H				P					
300	301										
330	331	H				P					
390	391	H				P					
470	471	H				E					
560	561	H				Q					
680	681	H				Q					
720	721										
820	821	H				J					
1000	102	H				J					
1200	122										
1500	152										
1800	182										
2200	222										
2700	272										
3300	332										
3900	392										
4700	472										
5600	562										
10 (nF)	103										
12	123										
15	153										
18	183										
22	223										
27	273										
33	333										
39	393										
47	473										
56	563										

Case Size	1808 (KGK42)				1812 (KGK43)			
Thickness Letter	G	B	H	N	P	E	Q	J
Max Thickness (mm)	1.55	1.80	2.20	1.35	1.55	1.80	2.20	2.80
Carrier Tape	EMB				EMB			
Packaging Code 7"reel	Y	Y	Y	V	V	V	V	V
Packaging Code 13"reel	K	K	K	S	S	S	S	S
Embossed(EMB)								

Safety Capacitors, KGH Series

Capacitance Range (X2 X7R)

SIZES AND CAPACITANCE RANGE

SIZE		1808		1812		2220	
(L) Length	mm	4.5	+0.60-0.30	4.5	+0.60-0.30	5.7	±0.50
	(in.)	0.177	+0.024-0.012	0.177	+0.024-0.012	0.224	±0.02
(W) Width	mm	2.00±0.30		3.20±0.40		5.00±0.50	
	(in.)	(0.079±0.012)		(0.126±0.016)		(0.197±0.02)	
(t) Terminal	mm	0.50±0.25		0.50±0.25		0.60±0.30	
	(in.)	(0.02±0.01)		(0.02±0.01)		0.024±0.012	
Certification		IEC60384-14					
Rated Voltage		250V _{ac}					
Impulse		2.5kV		2.5kV		2.5kV	
Cap	Code						
3.0 (pF)	3R0						
3.3	3R3						
3.9	3R9						
4.0	4R0						
4.7	4R7						
5.0	5R0						
5.6	5R6						
6.0	6R0						
6.8	6R8						
7.0	7R0						
8.0	8R0						
8.2	8R2						
9.0	9R0						
10	100						
12	120						
15	150						
18	180						
22	220						
27	270						
33	330						
39	390						
47	470						
56	560						
68	680						
82	820						
100	101						
120	121						
130	131						
150	151	B					
160	161	B					
180	181	B					
220	221	B					

SIZE		1808		1812		2220	
(L) Length	mm	4.5	+0.60-0.30	4.5	+0.60-0.30	5.7	±0.50
	(in.)	0.177	+0.024-0.012	0.177	+0.024-0.012	0.224	±0.02
(W) Width	mm	2.00±0.30		3.20±0.40		5.00±0.50	
	(in.)	(0.079±0.012)		(0.126±0.016)		(0.197±0.02)	
(t) Terminal	mm	0.50±0.25		0.50±0.25		0.60±0.30	
	(in.)	(0.02±0.01)		(0.02±0.01)		0.024±0.012	
Certification		IEC60384-14					
Rated Voltage		250V _{ac}					
Impulse		2.5kV		2.5kV		2.5kV	
270	271	B		E			
300	301	B		E			
330	331	B		E			
390	391	B		E			
470	471	B		E			
560	561	B		E			
680	681	B		E			
720	721	B		E			
820	821	B		E			
1000	102	H		E			
1200	122	H		E			
1500	152	H		Q			
1800	182	H		Q			
2200	222	H		J			
2700	272			J			
3300	332			J			
3900	392			J			
4700	472			J			
5600	562			J			
10 (nF)	103						C
12	123						C
15	153						C
18	183						C
22	223						G*
27	273						G*
33	333						G*
39	393						G*
47	473						G*
56	563						G*

*anti-arcing only

Case Size	1808 (KGK42)		1812 (KGK43)			2220 (KGK 55)	
Thickness Letter	B	H	E	Q	J	C	G
Max Thickness (mm)	1.80	2.20	1.80	2.20	2.80	2.80	3.10
Carrier Tape	EMB		EMB			EMB	
Packaging Code 7'reel	Y	Y	V	V	V	V	V
Packaging Code 13'reel	K	K	S	S	S	S	S
Embossed(EMB)							

Safety Capacitors, KGK and KGH Series

Specifications and Test Methods

TESTING METHODS

Item	Standard Methods	Test Condition				Requirements			
Visual examination and Dimensions	IEC 60384-14.1	---				* No remarkable defect.* Dimensions to confirm to individual specificationsheet.			
Capacitance	IEC 60384-14.2.2					* Capacitance is within specified tolerance. * CR means rated capacitance for conform to the E6 series of preferred values given in IEC 60063.			
Q/D.F. (Dissipation Factor)	IEC 60384-1 4.2.3	* Class I : (COG) Cap.≤1000pF, 1.0±0.2Vrms, 1MHz±10%. Cap.>1000pF, 1.0±0.2Vrms, 1KHz±10%. * Class II : (X7R) 1.0±0.2Vrms, 1KHz±10%.				Dielectric		Q/D.F.	Remark
						Class I (COG)		Q≥1000	Cap.≥30pF
								Q≥400+20C	Cap.<30pF
						Class II (X7R)		D.F.≤2.5%	-
Temperature Coefficient	IEC 60384-21/224.6	* With no electrical load.				T.C.		Capacitance Change	
		T.C.Operating Temp.				COG		±30ppm/°C	
		COG		-55~125°C at 25°C		X7R		±15%	
		X7R		-55~125°C at 25°C					
Voltage proof (Dielectric Strength)	IEC 60384-144.2.1	* To apply voltage : X Capacitor : 1075Vdc (4.3UR). Y Capacitor : 1500Vac. * Duration : 60 sec. * The charge current shall not exceed 0.05A. * The voltage shall be raised from the near zero to the test voltage a rate not exceeding 150V(r.m.s.)/sec. * For FK20X series : 4000Vdc / 1~5 sec. (Validation by UL)				* No evidence of damage or flash over during test.			
Insulation Resistance	IEC 60384-21/22 4.5.3	Rated Vol.(V)	Apply Voltage	Charge Current	Charge Time	Dielectric	Requirements		
		>500	500Vdc	≤50mA	60 sec.	Class I (COG)	≥100GΩ or RxC≥1000Ω-F, whichever is smaller		
						Class II (X7R)	≥10GΩ or RxC≥500Ω-F, whichever is smaller		
Solderability	IEC 60384-21/224.1	* Solder temperature : 245±5°C (1808~2220).* Dipping time : 2.0±0.5 sec.				*75% min. coverage of all metalized area			
Resistance to Soldering Heat	IEC 60384-144.4IEC 60384-21/224.9	* Solder temperature : 260±5°C.* Dipping time : 10±1 sec.* Preheating : 120 to 150°C for 1 minute beforeimmerse the capacitor in a eutectic solder.* Measurement to be made after keeping at roomtemperature for 24±2 hrs (Class I) and 48±4 hrs (Class II).				* Appearance :No remarkable damage.* Cap. change :COG within ±2.5% or ±0.25pF, whichever is larger.X7R within ±7.5%.* D.F. value :COG to meet initial requirement.X7R to meet initial requirement.* I.R. : ≥1GΩ.			
Temperature Cycle	IEC 60384-21/22 4.11	*Conduct the five cycles according to the temperature and time				*Appearance: No remarkable damage.			
		Step	Temp (°C)	Time (min.)		*Cap. Change: COG within ±2.5% or ±0.25pF, whichever is larger. X7R within ±7.5%.			
		1	Min. operating temp. +0/-3	30±3		*D.F. Value: COG to meet initial requirement X7R≤150% of initial requirement.			
		2	Room temp	2~3		*I.R. to meet initial requirement			
		3	Max. operating temp. +3/-0	30±3					
		4	Room temp	2~3					
		*Measurement to be made after keeping at room temperature for 24±2 hours (Class I) and 48 ± 4hrs (Class II)							
Humidity (Damp Heat) Steady State	IEC 60384-144.12	*Test Temp: 40±2°C*Humidity: 90~95% RH. *Test Time: 500 +24/-0 hrs* Applied Voltage :250 Vac. *Measurement to be made after keeping at room temp. for 24± 2 hours (Class I) and 48 ± 4 hrs (Class II)				*Appearance: No remarkable damage.*Cap. Change: COG within ±2.5% or ±0.25pF, whichever is larger.X7R within ±15%.*D.F. Value: COG≤0.25%X7R≤200%* I.R. : ≥1GΩ or RxC≥25Ω-F, whichever is smaller			
Passive Flammability	IEC 60384-144.17IEC 60384-14.38	* Volume sample : 21.56 mm3*Flame exposure time: 5 sec max. * Category of flammability : C				*Capacitor didn't burn at all			
Active Flammability	IEC 60384-144.17IEC 60384-14.38	*The capacitors applied UR (250Vac). Then each sample shall be subjected to 20 discharges from a tank capacitor, charged to a voltage that when discharged, places Ui 2500V for X2, Ui 5000V for X1Y2 across the capacitor under test. The interval between successive discharges shall be 5 sec.				*The cheese cloth shall not burn with a flame			

Safety Capacitors, KGK and KGH Series

Specifications and Test Methods

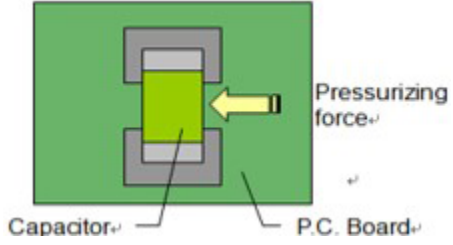
Item	Standard Methods	Test Condition	Requirements						
High Temperature Load (Endurance)	IEC 60384-144.14	<p>*Impulse Voltage: Each individual capacitor shall be subjected to a $V_p = 5.0KV$ (X1Y2 Class Impulse 5KV) or $V_p = 2.5KV$ (X2 Class Impulse 2.5KV) impulse for three times before applied to endurance test. Test temp: $125 \pm 3^\circ C$ Test time: 1000 +48/-0 hours</p> <p>*Applied Voltage: X capacitor: 1.25 UR (312.5 Vac) Y capacitor: 1.70 UR (425 Vac) Once every hour the voltage shall be increased to 1000 Vms for 0.1 sec *Measurement to be made after keeping at room temperature for 24±2 hours (Class I) and 48 ± 4hrs (Class II)</p>	<p>*Appearance: No mechanical damage*Cap change: COG within ±5% or ±0.50pF, whichever is larger.X7R within ± 20% *D.F. Value: $COG \leq 0.25\%$X7R $\leq 5.0\%$*Dielectric strength satisfies the specified initial value</p>						
Resistance to Flexure of Substrate	IEC 60384-21/22 4.8	<p>* The middle part of substrate shall be pressurized by means of the pressurizing rod at a rate of about 1mm per second until the deflection becomes 1mm</p> <p>*Flexitem: 3mm</p> <p>*Measurement to be made after keeping at room temperature for 24±2 hours</p>	*no remarkable damage						
			<table border="1"> <thead> <tr> <th>Dielectric</th> <th>Cap. Change</th> </tr> </thead> <tbody> <tr> <td>Class I (COG)</td> <td>Within ± 3.0% or ± 2.0 pF, whichever is larger</td> </tr> <tr> <td>Class II (X7R)</td> <td>Within ± 12.5%</td> </tr> </tbody> </table>	Dielectric	Cap. Change	Class I (COG)	Within ± 3.0% or ± 2.0 pF, whichever is larger	Class II (X7R)	Within ± 12.5%
			Dielectric	Cap. Change					
Class I (COG)	Within ± 3.0% or ± 2.0 pF, whichever is larger								
Class II (X7R)	Within ± 12.5%								
(The capacitance change means the change of the capacitance under specified flexure of substrate from the capacitance measured before the test)									
Adhesive Strength of Termination	IEC 60384-21/22 4.15 IEC 60384-1 4.13	<p>* Capacitors mounted on a substrate. A force of 10N applied perpendicular to the place of substrate and parallel the line joining the center of terminations for 10±1 sec.</p> 	*No remarkable damage or removal of the terminations						

Safety Capacitors, KGK and KGH Series

Packaging Options

PACKAGE DIMENSIONS AND QUANTITY

Size	Max Thickness	Plastic Tape	
	(mm)	7" reel	13" reel
1808 (4520)	1.55	2k	10k
	1.80	2k	8k
	2.20	1k	6k
1812 (4532)	1.35	1k	5k
	1.55	1k	5k
	1.80	1k	4k
	2.20	1k	3k
	2.80	0.5k	3k
	3.10	0.5k	2k
2211 (5728)	1.80	1k	4k
	2.20	1k	3k
	2.80	0.5k	3k
	3.10	0.5k	-
2220 (5750)	2.20	1k	3k
	2.80	0.5k	2k
	3.10	0.5k	2k

REEL DIMENSIONS

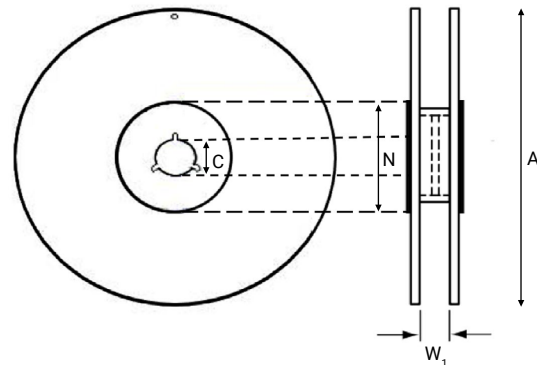

Size	1808, 1812, 2211, 2220
Reel Size	7"
C	13.0 ^{+0.5}
W ₁	12.4 ^{+2.0}
A	178.0 ^{+0.1}
N	60.0 ^{+0.2}

EMBOSSED TAPE DIMENSIONS

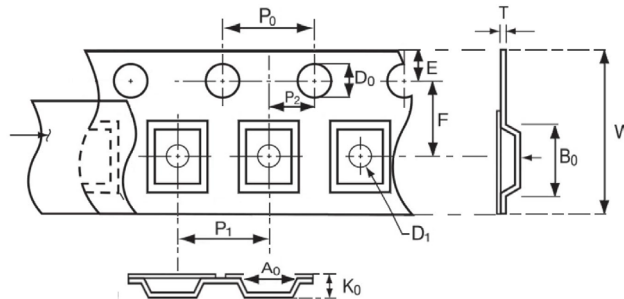

Size	Chip Thickness	A ₀	B ₀	T	K ₀	W	P ₀	10xP ₀	P ₁	P ₂	D ₀	D ₁	E	F
1808	1.40±0.15	<2.50	<5.30	0.25±0.05	<2.50	12.00±0.20	4.00±0.10	40.00±0.20	4.00±0.10	2.00±0.05	1.50+0.10	1.50+0.10	1.75±0.10	5.50±0.05
	1.60±0.20													
	2.00±0.20													
1812	1.25±0.10	<3.90	<5.30	0.25±0.05	<2.50	12.00±0.20	4.00±0.10	40.00±0.20	8.00±0.10	2.00±0.05	1.50+0.10	1.50+0.10	1.75±0.10	5.50±0.05
	1.40±0.15													
	1.60±0.20													
	2.00±0.20													
	2.50±0.30													
	2.80±0.30													
2211	1.60±0.20	<3.30	<6.50	0.30±0.10	<2.50	12.00±0.20	4.00±0.10	40.00±0.20	8.00±0.10	2.00±0.05	1.50+0.10	1.50+0.10	1.75±0.10	5.50±0.05
	2.00±0.20													
	2.50±0.30													
	2.80±0.30													
2220	2.00±0.20	<5.80	<6.50	0.30±0.10	<2.50	12.00±0.20	4.00±0.10	40.00±0.20	8.00±0.10	2.00±0.05	1.50+0.10	1.50+0.10	1.75±0.10	5.50±0.05
	2.50±0.30													
	2.80±0.30													

Safety Capacitors, KGK and KGH Series

Application Notes

STORAGE

To prevent the damage of solderability of terminations, the following conditions are recommended:

- Indoors under 5~40°C
- No harmful gases containing sulfuric acid, ammonia, hydrogen sulfide or chlorine
- Packaging should not be opened until the capacitors are required for use. If opened, the pack should be resealed as soon as possible. Taped product should be store out of direct sunlight, which might promote deterioration in tape or adhesion performance
- The Product is recommended to be used within 12 months after shipment and checked the solderability before use

HANDLING

Chip capacitors are dense, hard, brittle, and abrasive materials. They are liable to suffer mechanical damage, in the form of cracks or chips. Chip capacitors should be handled with care to avoid contamination or damage. The use of tweezers or vacuum pick ups is strongly recommended for manual placement. Taped and reeled components provides the ideal medium for direct presentation to the placement machine.

PREHEAT

It is important to avoid the possibility of thermal shock during soldering and carefully controlled preheat is therefore required. The rate of preheat should not exceed 3°C per second.

SOLDERING

Use mildly activated rosin fluxes, do not use activated fluxes. The amount of solder in each solder joint should be controlled to prevent the damage of chip capacitors caused by the stress between solder, chips, and substrate.

a.) Hand Soldering

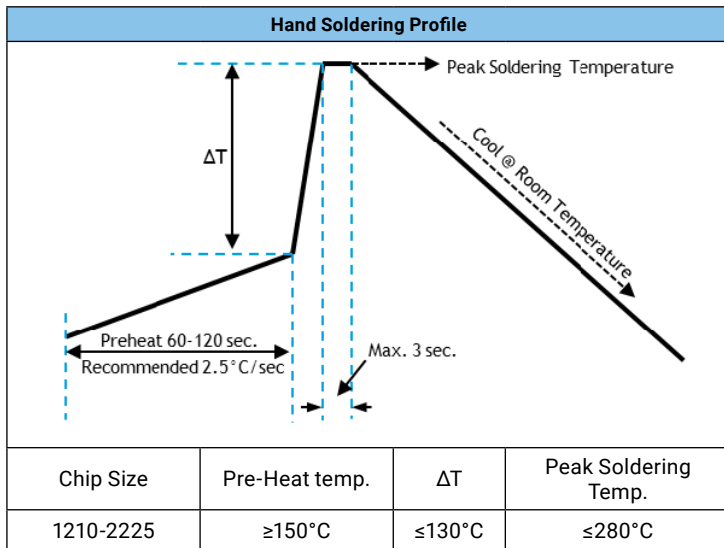

- *Soldering iron tip diameter: ≤1.0mm & wattage max: 20W.
- *The Capacitors shall be pre-heated so that the temperature gradient between the devices and the soldering iron tip is minimized.
- *The required amount of solder shall be melted on the soldering tip.
- *The tip of iron should not contact the ceramic body directly.
- *The Capacitors shall be cooled gradually at room temperature after soldering.
- *Forced air cooling is not allowed.

b.) Reflow Soldering:

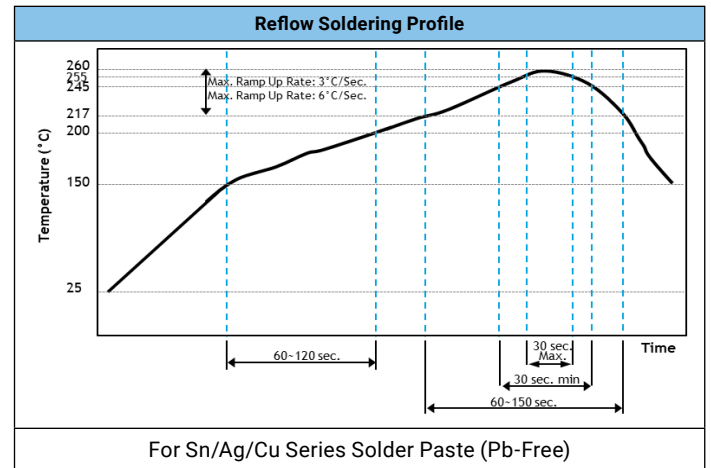

Soldering Height :

The recommended height is 25% of the capacitor thickness or 0.5mm, whichever is less. (Reference from IPC-610E)

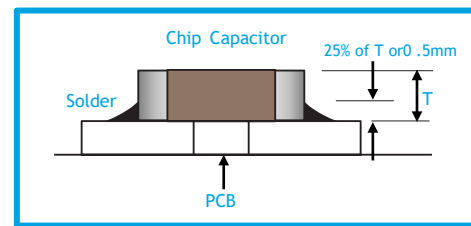

c.) Wave Soldering : Not Applicable to Wave Soldering.

COOLING

After soldering, cool the chips and the substrate gradually to room temperature. Natural cooling in air is preferred to minimize stress in the solder joint.

CLEANING

Flux residues may be hygroscopic or acidic and must be removed to eliminate contamination that could cause electrolytic surface corrosion. Removal must be done by suitable electronic-grade vapor-cleaning solvents. Good results can be obtained by using ultrasonic cleaning of the solvent. The choice of the proper system depends upon many factors such as component mix, flux, and solder paste and assembly method. The ability of the cleaning system to remove flux residues and contamination from under the chips is very important.

X-ON Electronics

Largest Supplier of Electrical and Electronic Components

Click to view similar products for [Safety Capacitors](#) category:

Click to view products by [Kyocera AVX](#) manufacturer:

Other Similar products are found below :

[B32022B3223K026](#) [B32912A3104K026](#) [B81123C1102M003](#) [MKPY2-.02230020P15](#) [46KN333000M1M](#) [46KN422000P0M](#)
[F1778433K2FBB0](#) [DE1E3KX222MJ4BN01F](#) [46KR422000M1K](#) [MP1125KRE6RLC](#) [MP2683KGC2XLC](#) [MP2124KGC3XLC](#)
[MP2684KGD4XLC](#) [MP2474KGE1XLC](#) [46KF268000M1M](#) [46KI3150NDM2M](#) [PHE840MD6220MD13R30](#) [PHE840MY6470MD14R06](#)
[PHE845VD5470MR06](#) [R463N4100ZAM1K](#) [MKPX2R-1/400/10P27](#) [YP500101K040B20C2P](#) [YU0AH222M090DAMD0B](#)
[LS1808N102K302NX080TM](#) [VY2103M59Y5VS63V7](#) [CY1471KE1IEB46X2A2](#) [CY1222ME5IEE48O2A2](#) [MPX474K31DTEV158G0](#)
[Y2560K-D1I-B4-AC250V](#) [HMF222MG3BW](#) [CY1471ME19EE45W2A2](#) [MPX104K31D2KN158HF](#) [MPX224K31D2KN158G0](#)
[PX104K2W1502](#) [C47S1472K60C000](#) [MP2224K32C5J6LC](#) [H102M050FQ55250L750A](#) [MP2474K32D6R8LC](#) [MP2224K32C3J6LC](#)
[MP2104K32C3J6LC](#) [PX334K2C1006](#) [YU0AC222M080L20C7B](#) [MP2473K27B2X6LC](#) [MP2224K32D4J8LC](#) [MP2684K32D6T8LC](#)
[ST3Y1Y5U332M500VAC](#) [ST3Y1Y5V472M500VAC](#) [MP2474K32D4X8LC](#) [MP2474K32D4J8LC](#) [YU0AH332M110L4EB0B](#)