

Multilayer Organic (MLO®) Filters

MLO® Low Pass Filters

General Information

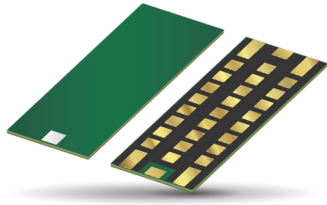

GENERAL DESCRIPTION

The MLO® Low Pass Filters are low profile passive devices with best in class performance based on AVX's patented multilayer organic high density interconnect technology. The MLO® low pass filters utilize high dielectric constant and low loss materials to realize high Q passive printed elements, such as inductors and capacitors, in a multilayer stack. This results in a 50Ω Low Pass Filter design. MLO® Low Pass Filters can support both a variety of frequency bands and multiple wireless standards, and are less than 1.0mm in thickness. All filters are expansion matched to most organic PCB materials, thereby resulting in improved reliability over standard Si and ceramic devices.

FEATURES

- Wide Frequency Range
- Excellent Isolation
- Low Loss
- Expansion matched to PCB
- 50Ω Impedance
- Surface Mountable
- RoHS Compliant

APPLICATIONS

- Mobile Communication
- GPS
- Vehicle location systems
- Wireless LANs
- Satellite Receivers
- Instrumentation

LAND GRID ARRAY ADVANTAGES

- Inherent Low Profile
- Excellent Solderability
- Better Heat Dissipation

HOW TO ORDER

LP T Series Low Pass Filters	OB T Case Size 0A = 2616 0B = 3116 0C = 3416 0D = 4016 1E = 4617 2E = 4614 0E = 4617 0F = 5021	A T Type	1330 T Frequency in MHz	A T Standard Testing	7 T Termination 7 - Gold	00 T Package Code 00 - Standard TR - 1000 pcs Tape & Reel TR\250 - 250 pcs Tape & Reel
---	--	------------------------------	--	--	---	---

QUALITY INSPECTION

Finished Parts are 100% electrically tested

TERMINATION

All finishes are compatible with automatic soldering technologies: Pb free reflow, wave soldering, vapor phase, and manual soldering.

OPERATING TEMPERATURE

-55°C to +85°C



For RoHScompliant products, please select correct termination style



S2P FILES, DRAWING AND OTHER INFORMATION AVAILABLE IN LINK ON INDIVIDUAL DATASHEETS

Multilayer Organic (MLO®) Filters

MLO® Low Pass Filters

ELECTRICAL SPECIFICATIONS

Part Number	IL < 1.2dB Passband DC - f0 (GHz)	Passband Typical (dB)	Typical 3dB (GHz)	30dB Rejection		Power (W)	Thickness Mils
				Min (GHz)	Max (GHz)		
LP0FA0054A7**	0.054	-0.9	0.071	0.083	0.700	4 Watts	40
LP0FA0056A7**	0.057	-0.9	0.072	0.089	0.700	4 Watts	40
LP0FA0057A7**	0.057	-0.9	0.073	0.090	0.700	4 Watts	40
LP0EA0076A7**	0.076	-0.9	0.096	0.115	0.800	4 Watts	40
LP0EA0080A7**	0.080	-0.9	0.102	0.121	0.800	4 Watts	40
LP0EA0082A7**	0.082	-0.8	0.105	0.125	0.800	4 Watts	40
LP0DA0102A7**	0.102	-0.9	0.132	0.155	0.900	4 Watts	40
LP0DA0107A7**	0.107	-0.9	0.136	0.160	0.900	4 Watts	40
LP0DA0112A7**	0.112	-0.9	0.143	0.167	0.900	4 Watts	40
LP0AA0141A7**	0.141	-0.8	0.172	0.212	2.000	4 Watts	40
LP0AA0145A7**	0.145	-0.9	0.174	0.224	2.000	4 Watts	40
LP0AA0149A7**	0.149	-0.8	0.182	0.224	2.000	4 Watts	40
LP0AA0153A7**	0.153	-0.8	0.189	0.231	2.000	4 Watts	40
LP0AA0156A7**	0.156	-0.8	0.192	0.236	2.000	4 Watts	40
LP0AA0161A7**	0.161	-0.8	0.197	0.241	2.000	4 Watts	40
LP0AA0171A7**	0.171	-0.8	0.207	0.255	2.000	4 Watts	40
LP0AA0174A7**	0.174	-0.8	0.212	0.260	2.000	4 Watts	40
LP0AA0185A7**	0.185	-0.8	0.220	0.270	2.000	4 Watts	40
LP0AA0194A7**	0.194	-0.8	0.241	0.289	2.000	4 Watts	40
LP0AA0204A7**	0.204	-0.8	0.245	0.293	2.000	4 Watts	40
LP0AA0209A7**	0.209	-0.8	0.252	0.303	2.000	4 Watts	40
LP0AA0279A7**	0.279	-0.8	0.339	0.398	2.000	4 Watts	40
LP0AA0290A7**	0.290	-0.8	0.351	0.415	2.000	4 Watts	40
LP0AA0299A7**	0.299	-0.8	0.363	0.427	2.000	4 Watts	40
LP0AA0316A7**	0.316	-0.8	0.378	0.446	2.000	4 Watts	40
LP0AA0322A7**	0.322	-0.8	0.386	0.454	2.000	4 Watts	40
LP0AA0327A7**	0.327	-0.8	0.392	0.462	2.000	4 Watts	40



Click on part number to see full specifications

**Packaging: 00 = waffle pack, TR = 1000pcs T&R, TR1250 = 250pcs T&R

Multilayer Organic (MLO®) Filters

MLO® Low Pass Filters



ELECTRICAL SPECIFICATIONS

Part Number	IL < 1.2dB	Passband Typical (dB)	Typical 3dB (GHz)	30dB Rejection		40dB Rejection		Power (W)	Thickness Mils
	Passband DC - f0 (GHz)			Min (GHz)	Max (GHz)	Min (GHz)	Max (GHz)		
LP1EA0320A7**	0.320	-0.9	0.37	0.45	3.20	0.46	1.20	4	40
LP0DA0410A7**	0.410	-0.9	0.49	0.58	5.00	0.60	4.00	4	22
LP1EA0500A7**	0.500	-0.9	0.57	0.67	4.50	0.68	2.25	4	40
LP0CA0550A7**	0.550	-0.9	0.67	0.79	6.00	0.81	4.00	4	22
LP0FA0600A7**	0.600	-1.0	0.77	0.93	9.00	0.96	9.00	4	22
LP1EA0720A7**	0.720	-0.8	0.83	0.97	5.00	0.99	5.00	4	40
LP0BA0790A7**	0.790	-0.9	0.94	1.10	9.00	1.12	7.00	4	22
LP0BA0960A7**	0.960	-0.9	1.15	1.34	4.00	-	-	4	22
LP0BA1010A7**	1.010	-0.9	1.22	1.42	4.00	-	-	4	22
LP0BA1030A7**	1.030	-0.9	1.30	1.63	6.47	1.71	6	4	22
LP2EA1080A7**	1.080	-0.8	1.21	1.46	5.00	1.48	3.40	4	40
LP0BA1220A7**	1.220	-0.8	1.37	1.55	5.50	1.89	5.00	4	22
LP0BA1330A7**	1.330	-0.9	1.52	1.72	6.00	-	-	4	22
LP0BA1390A7**	1.390	-0.9	1.57	1.79	6.00	-	-	4	22
LP0AA1590A7**	1.590	-0.8	1.84	2.11	9.00	2.15	7.75	4	40
LP0AA1610A7**	1.610	-0.9	1.80	2.22	9.00	2.32	5.00	4	22
LP0AA1620A7**	1.620	-0.7	1.87	2.15	7.00	2.19	6.00	4	40
LP0AA1630A7**	1.630	-0.7	1.91	2.18	8.00	2.22	3.00	4	40
LP0AA1670A7**	1.670	-0.7	2.00	2.30	8.00	2.36	7.00	4	40
LP2EA1680A7**	1.680	-0.8	1.86	2.18	9.00	2.22	4.00	4	40
LP0AA1680A7**	1.680	-0.7	2.01	2.32	8.00	2.38	7.00	4	40
LP2EA1770A7**	1.770	-0.8	1.97	2.33	5.00	2.37	4.50	4	40
LP0DA1780A7**	1.780	-0.9	1.97	2.27	5.00	2.35	4.00	4	40
LP0DA1800A7**	1.800	-0.8	2.02	2.30	6.00	2.40	4.00	4	40
LP0DA1810A7**	1.810	-0.8	2.04	2.29	6.00	2.48	4.00	4	40
LP0DA1840A7**	1.840	-0.7	2.04	2.27	5.50	2.44	4.00	4	40
LP0DA1880A7**	1.880	-0.8	2.05	2.28	6.00	2.42	4.00	4	40
LP0DA1890A7**	1.890	-0.8	2.13	2.38	7.00	-	-	4	40
LP0DA1950A7**	1.950	-0.8	2.20	2.53	8.00	-	-	4	40
LP0DA2100A7**	2.100	-0.8	2.37	2.68	9.00	2.72	5.11	4	22
LP0DA2140A7**	2.140	-0.7	2.38	2.68	9.00	2.72	5.23	4	22
LP0DA2160A7**	2.160	-0.8	2.41	2.72	5.00	-	-	4	22
LP0DA2190A7**	2.190	-0.6	2.44	2.79	6.50	2.93	4.00	4	40
LP0DA2200A7**	2.200	-0.8	2.50	2.84	5.00	4.00	5.00	4	22
LP0DA2210A7**	2.210	-0.8	2.60	2.98	8.50	3.25	4.25	4	40
LP0DA2260A7**	2.260	-0.8	2.50	2.86	5.00	4.00	5.00	4	22
LP0AA2300A7**	2.300	-0.9	2.56	3.15	9.00	3.26	9.00	4	22
LP0AA2490A7**	2.490	-0.7	2.80	3.98	9.00	3.79	5.00	4	40
LP2EA2530A7**	2.530	-0.7	2.87	3.28	9.00	3.32	6.50	4	40
LP0AA2590A7**	2.590	-0.7	2.89	3.71	9.00	3.87	5.20	4	40
LP2EA2600A7**	2.600	-0.7	2.95	3.40	9.00	3.50	6.00	4	40
LP0AA2640A7**	2.640	-0.8	2.97	3.82	9.00	3.98	5.50	4	40
LP0AA2910A7**	2.910	-0.8	3.43	4.07	9.00	4.80	8.00	4	22
LP0AA2980A7**	2.980	-0.7	3.52	4.17	9.00	4.29	8.00	4	22
LP0AA3100A7**	3.100	-0.7	3.65	4.32	9.00	5.00	8.00	4	22
LP0AA3160A7**	3.160	-0.8	3.47	4.36	9.00	4.47	9.00	4	22
LP0AA4080A7**	4.080	-0.7	5.03	5.62	9.00	5.69	9.00	4	22
LP0AA4150A7**	4.150	-0.6	5.16	5.75	9.00	5.82	9.00	4	22
LP0AA4210A7**	4.210	-0.7	5.28	5.87	9.00	6.16	9.00	4	22
LP0AA4370A7**	4.370	-0.8	4.84	6.00	9.00	6.32	9.00	4	22
LP0AA6160A7**	6.160	-0.9	7.09	8.59	13.00	8.82	11.50	4	22

Click on part number to see full specifications

**Packaging: 00 = waffle pack, TR = 1000pcs T&R, TR1250 = 250pcs T&R



Multilayer Organic (MLO®) Filters

MLO® Low Pass Filters

LP1EA0320A7**

ELECTRICAL SPECIFICATIONS

Pass Band	DC - 0.320 GHz	1.2 dB	Max
	DC - 0.320 GHz	0.9 dB	Typ
	3dB Cutoff	0.37 GHz	Typ
Rejection	0.45 - 3.20 GHz	30dB	Min
	0.46 - 1.20 GHz	40dB	Min
Dimension	Thickness	40 Mils	Max
RF Power	Power	4 Watts	Max

[Click here to return to main table.](#)



**CLICK HERE TO DOWNLOAD
DATA FILES**

*Data files contain DXF and S2P files

DIMENSIONS – CASE SIZE 1E

Bottom View

inches (mm)

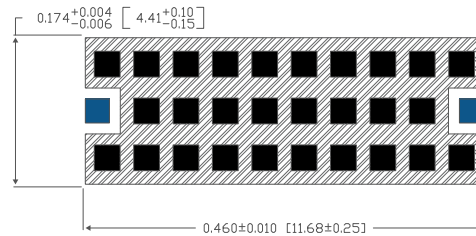

Typical Frequency Response

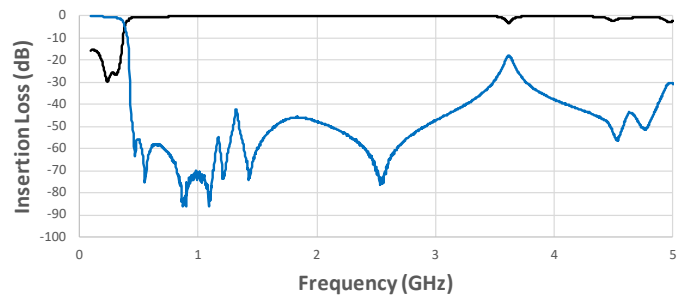

LP0DA0410A7**

ELECTRICAL SPECIFICATIONS

Pass Band	DC - 0.410 GHz	1.2 dB	Max
	DC - 0.410 GHz	0.9 dB	Typ
	3dB Cutoff	0.49 GHz	Typ
Rejection	0.58 - 5.00 GHz	30dB	Min
	0.60 - 4.00 GHz	40dB	Min
Dimension	Thickness	22 Mils	Max
RF Power	Power	4 Watts	Max

[Click here to return to main table.](#)



**CLICK HERE TO DOWNLOAD
DATA FILES**

*Data files contain DXF and S2P files

DIMENSIONS – CASE SIZE D

Bottom View

inches (mm)

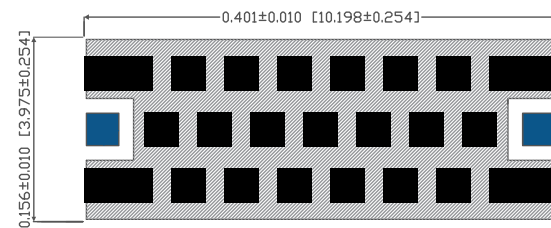

Typical Frequency Response

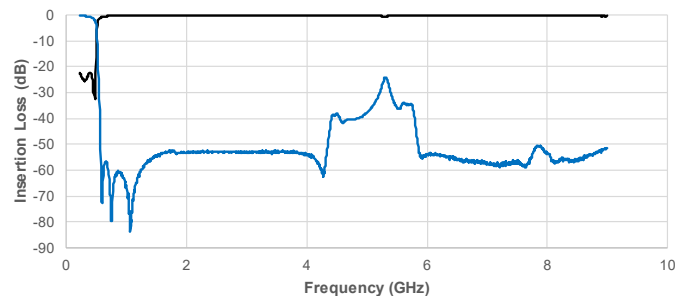

Multilayer Organic (MLO®) Filters

MLO® Low Pass Filters

LP1EA0500A7**

ELECTRICAL SPECIFICATIONS

Pass Band	DC - 0.500 GHz	1.2 dB	Max
	DC - 0.500 GHz	0.9 dB	Typ
	3dB Cutoff	0.57 GHz	Typ
Rejection	0.67 - 4.50 GHz	30dB	Min
	0.68 - 2.25 GHz	40dB	Min
Dimension	Thickness	40 Mils	Max
RF Power	Power	4 Watts	Max

[Click here to return to main table.](#)



**CLICK HERE TO DOWNLOAD
DATA FILES**

*Data files contain DXF and S2P files

DIMENSIONS – CASE SIZE 1E

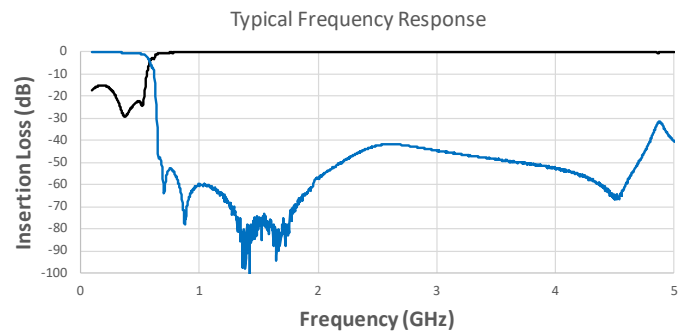
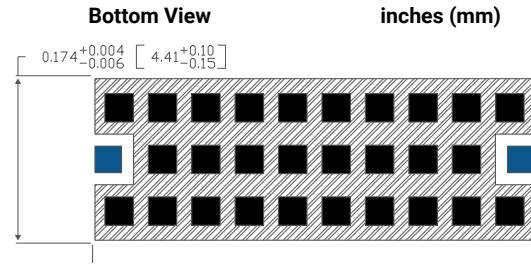

LP0CA0550A7**

ELECTRICAL SPECIFICATIONS

Pass Band	DC - 0.550 GHz	1.2 dB	Max
	DC - 0.550 GHz	0.9 dB	Typ
	3dB Cutoff	0.67 GHz	Typ
Rejection	0.79 - 6.00 GHz	30dB	Min
	0.81 - 4.00 GHz	40dB	Min
Dimension	Thickness	22 Mils	Max
RF Power	Power	4 Watts	Max

[Click here to return to main table.](#)



**CLICK HERE TO DOWNLOAD
DATA FILES**

*Data files contain DXF and S2P files

DIMENSIONS – CASE SIZE C

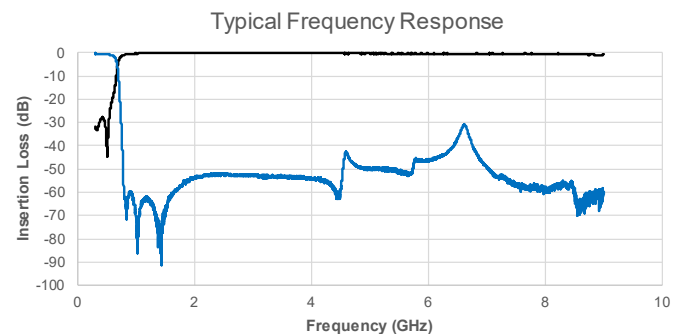
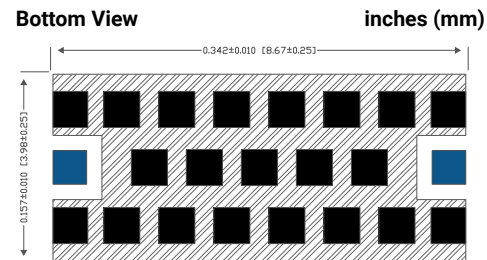

Multilayer Organic (MLO®) Filters

MLO® Low Pass Filters

LP0FA0600A7**

ELECTRICAL SPECIFICATIONS

Pass Band	DC - 0.600 GHz	1.2 dB	Max
	DC - 0.600 GHz	1.0 dB	Typ
	3dB Cutoff	0.77 GHz	Typ
Rejection	0.93 - 9.00 GHz	30dB	Min
	0.96 - 9.00 GHz	40dB	Min
Dimension	Thickness	22 Mils	Max
RF Power	Power	4 Watts	Max

[Click here to return to main table.](#)



**CLICK HERE TO DOWNLOAD
DATA FILES**

*Data files contain DXF and S2P files

DIMENSIONS – CASE SIZE F

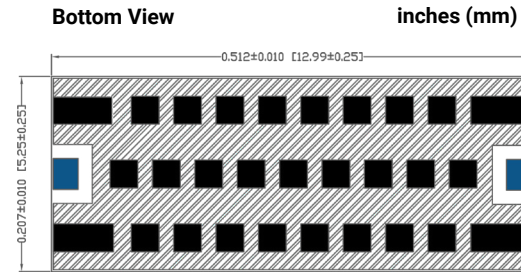

Typical Frequency Response

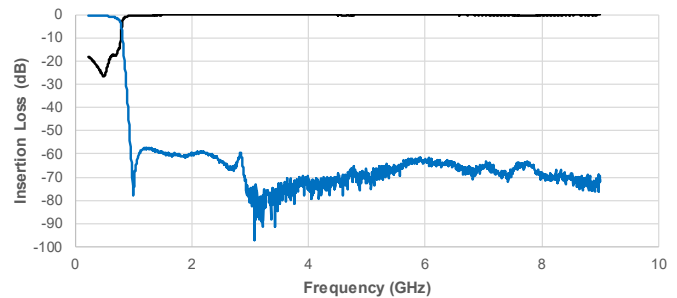

LP1EA0720A7**

ELECTRICAL SPECIFICATIONS

Pass Band	DC - 0.720 GHz	1.2 dB	Max
	DC - 0.720 GHz	0.8 dB	Typ
	3dB Cutoff	0.83 GHz	Typ
Rejection	0.97 - 5.00 GHz	30dB	Min
	0.99 - 5.00 GHz	40dB	Min
Dimension	Thickness	40 Mils	Max
RF Power	Power	4 Watts	Max

[Click here to return to main table.](#)



**CLICK HERE TO DOWNLOAD
DATA FILES**

*Data files contain DXF and S2P files

DIMENSIONS – CASE SIZE 1E

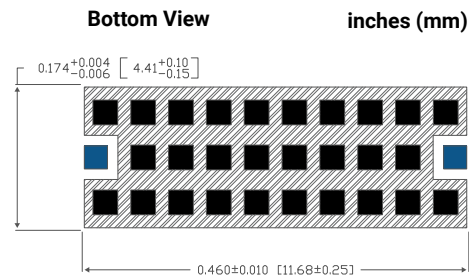

Typical Frequency Response

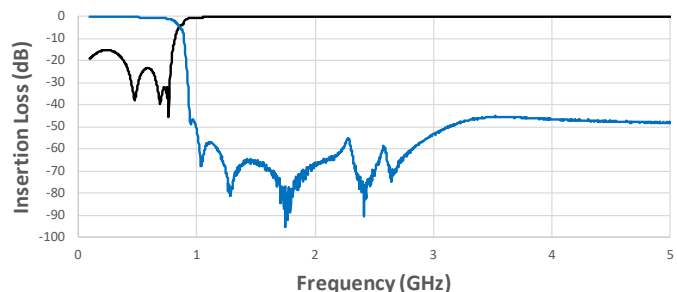

Multilayer Organic (MLO®) Filters

MLO® Low Pass Filters



LP0BA0790A7**

ELECTRICAL SPECIFICATIONS

Pass Band	DC - 0.790 GHz	1.2 dB	Max
	DC - 0.795 GHz	0.9 dB	Typ
	3dB Cutoff	0.94 GHz	Typ
Rejection	1.10 - 9.00 GHz	30dB	Min
	1.12 - 7.00 GHz	40dB	Min
Dimension	Thickness	22 Mils	Max
RF Power	Power	4 Watts	Max

[Click here to return to main table.](#)



CLICK HERE TO DOWNLOAD DATA FILES

*Data files contain DXF and S2P files

DIMENSIONS – CASE SIZE B

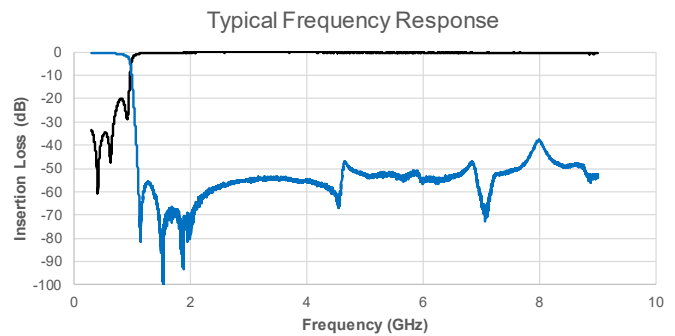
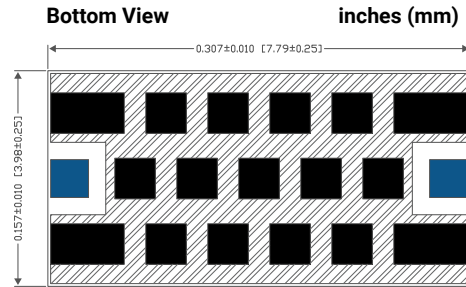

LP0BA0960A7**

ELECTRICAL SPECIFICATIONS

Pass Band	DC - 0.960 GHz	1.2 dB	Max
	DC - 0.960 GHz	0.9 dB	Typ
	3dB Cutoff	1.15 GHz	Typ
Rejection	1.34 - 4.00 GHz	30dB	Min
	- GHz	40dB	Min
Dimension	Thickness	22 Mils	Max
RF Power	Power	4 Watts	Max

[Click here to return to main table.](#)



CLICK HERE TO DOWNLOAD DATA FILES

*Data files contain DXF and S2P files

DIMENSIONS – CASE SIZE B

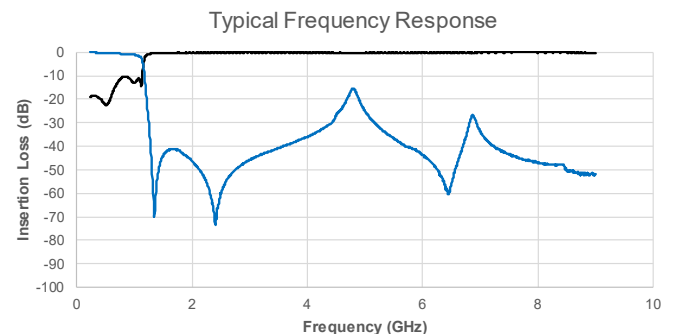
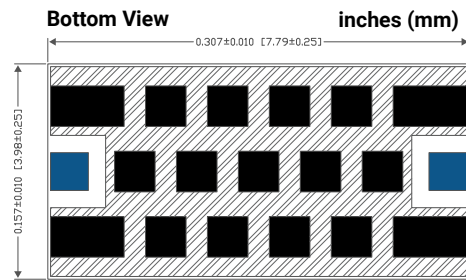

Multilayer Organic (MLO®) Filters

MLO® Low Pass Filters

LP0BA1010A7**

ELECTRICAL SPECIFICATIONS

Pass Band	DC - 1.010 GHz	1.2 dB	Max
	DC - 1.010 GHz	0.9 dB	Typ
	3dB Cutoff	1.22 GHz	Typ
Rejection	1.42 - 4.00 GHz	30dB	Min
	- GHz	40dB	Min
Dimension	Thickness	22 Mils	Max
RF Power	Power	4 Watts	Max

[Click here to return to main table.](#)

 **CLICK HERE TO DOWNLOAD DATA FILES**

*Data files contain DXF and S2P files

DIMENSIONS – CASE SIZE B

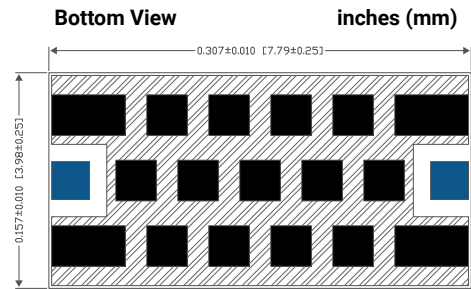

Typical Frequency Response

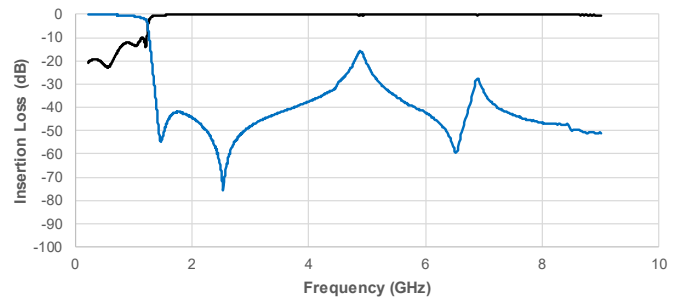

LP0BA1030A7**

ELECTRICAL SPECIFICATIONS

Pass Band	DC - 1.030 GHz	1.2 dB	Max
	DC - 1.030 GHz	0.9 dB	Typ
	3dB Cutoff	1.30 GHz	Typ
Rejection	1.63 - 6.47 GHz	30dB	Min
	1.71 - 6 GHz	40dB	Min
Dimension	Thickness	22 Mils	Max
RF Power	Power	4 Watts	Max

[Click here to return to main table.](#)

 **CLICK HERE TO DOWNLOAD DATA FILES**

*Data files contain DXF and S2P files

DIMENSIONS – CASE SIZE B

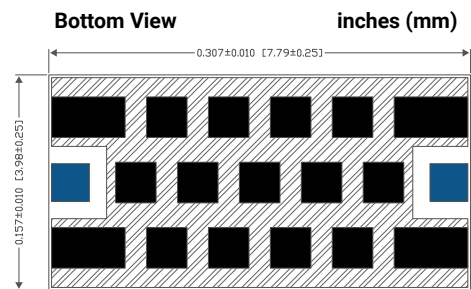

Typical Frequency Response

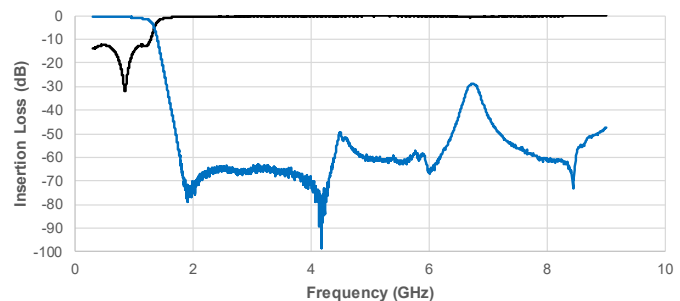

Multilayer Organic (MLO®) Filters

MLO® Low Pass Filters

LP2EA1080A7**

ELECTRICAL SPECIFICATIONS

Pass Band	DC - 1.080 GHz	1.2 dB	Max
	DC - 1.080 GHz	0.8 dB	Typ
	3dB Cutoff	1.21 GHz	Typ
Rejection	1.46 - 5.00 GHz	30dB	Min
	1.48 - 3.40 GHz	40dB	Min
Dimension	Thickness	40 Mils	Max
RF Power	Power	4 Watts	Max

[Click here to return to main table.](#)



**CLICK HERE TO DOWNLOAD
DATA FILES**

*Data files contain DXF and S2P files

DIMENSIONS – CASE SIZE 2E

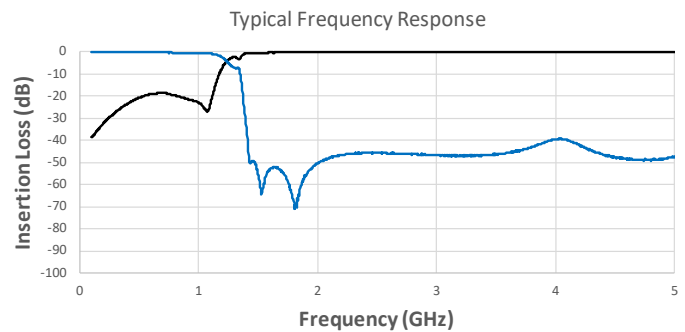
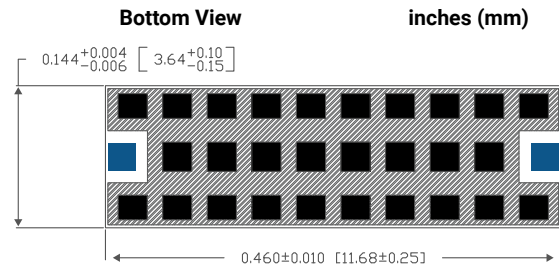

LP0BA1220A7**

ELECTRICAL SPECIFICATIONS

Pass Band	DC - 1.220 GHz	1.2 dB	Max
	DC - 1.220 GHz	0.8 dB	Typ
	3dB Cutoff	1.37 GHz	Typ
Rejection	1.55 - 5.50 GHz	30dB	Min
	1.89 - 5.00 GHz	40dB	Min
Dimension	Thickness	22 Mils	Max
RF Power	Power	4 Watts	Max

[Click here to return to main table.](#)



**CLICK HERE TO DOWNLOAD
DATA FILES**

*Data files contain DXF and S2P files

DIMENSIONS – CASE SIZE B

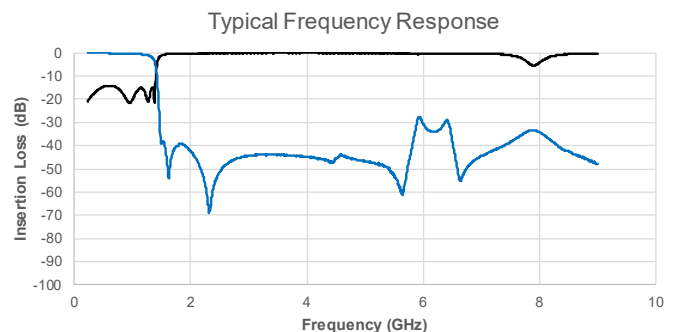
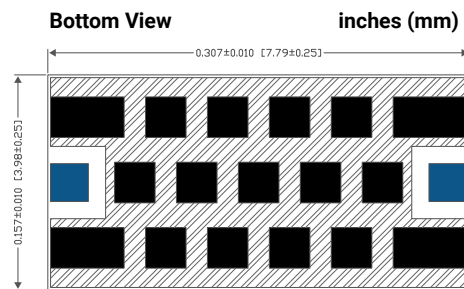

Multilayer Organic (MLO®) Filters

MLO® Low Pass Filters

LP0BA1330A7**

ELECTRICAL SPECIFICATIONS

Pass Band	DC - 1.330 GHz	1.2 dB	Max
	DC - 1.330 GHz	0.9 dB	Typ
	3dB Cutoff	1.52 GHz	Typ
Rejection	1.72 - 6.00 GHz	30dB	Min
	- GHz	40dB	Min
Dimension	Thickness	22 Mils	Max
RF Power	Power	4 Watts	Max

[Click here to return to main table.](#)

 **CLICK HERE TO DOWNLOAD DATA FILES**

*Data files contain DXF and S2P files

DIMENSIONS – CASE SIZE B

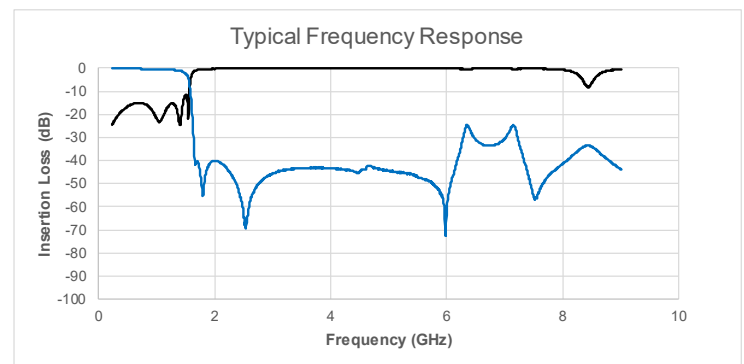
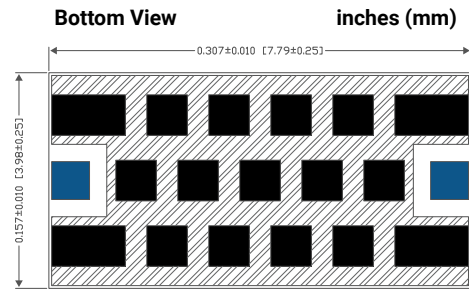

LP0BA1390A7**

ELECTRICAL SPECIFICATIONS

Pass Band	DC - 1.390 GHz	1.2 dB	Max
	DC - 1.390 GHz	0.9 dB	Typ
	3dB Cutoff	1.57 GHz	Typ
Rejection	1.79 - 6.00 GHz	30dB	Min
	- GHz	40dB	Min
Dimension	Thickness	22 Mils	Max
RF Power	Power	4 Watts	Max

[Click here to return to main table.](#)

 **CLICK HERE TO DOWNLOAD DATA FILES**

*Data files contain DXF and S2P files

DIMENSIONS – CASE SIZE B

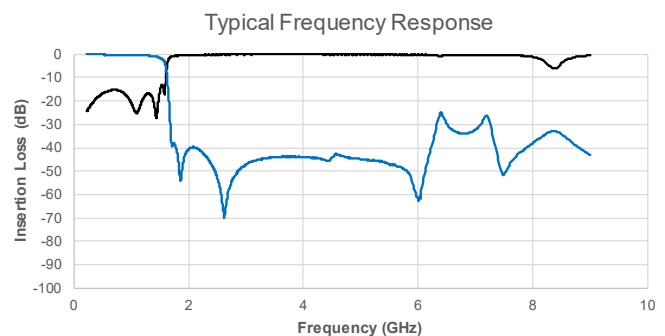
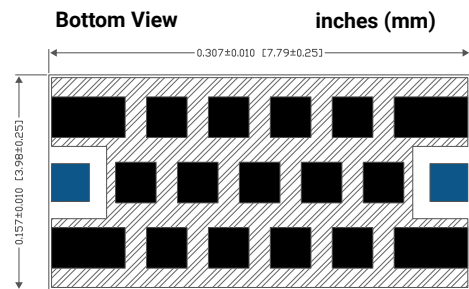

Multilayer Organic (MLO®) Filters

MLO® Low Pass Filters

LP0AA1590A7**

ELECTRICAL SPECIFICATIONS

Pass Band	DC - 1.590 GHz	1.2 dB	Max
	DC - 1.590 GHz	0.8 dB	Typ
	3dB Cutoff	1.84 GHz	Typ
Rejection	2.11 - 9.00 GHz	30dB	Min
	2.15 - 7.75 GHz	40dB	Min
Dimension	Thickness	40 Mils	Max
RF Power	Power	4 Watts	Max

[Click here to return to main table.](#)



**CLICK HERE TO DOWNLOAD
DATA FILES**

*Data files contain DXF and S2P files

DIMENSIONS – CASE SIZE A

Bottom View inches (mm)

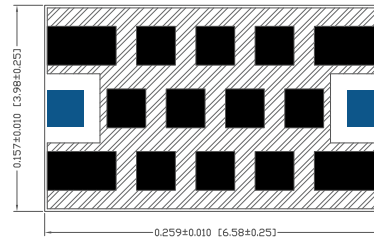

Typical Frequency Response

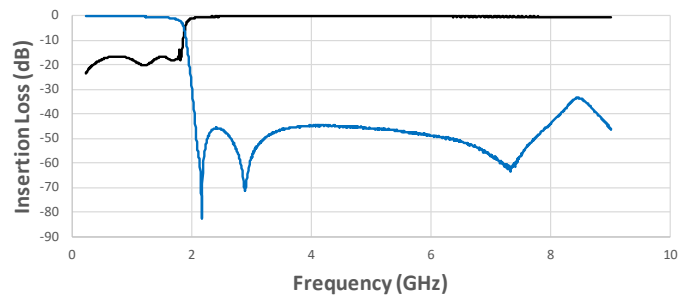

LP0AA1610A7**

ELECTRICAL SPECIFICATIONS

Pass Band	DC - 1.610 GHz	1.2 dB	Max
	DC - 1.610 GHz	0.9 dB	Typ
	3dB Cutoff	1.80 GHz	Typ
Rejection	2.22 - 9.00 GHz	30dB	Min
	2.32 - 5.00 GHz	40dB	Min
Dimension	Thickness	22 Mils	Max
RF Power	Power	4 Watts	Max

[Click here to return to main table.](#)



**CLICK HERE TO DOWNLOAD
DATA FILES**

*Data files contain DXF and S2P files

DIMENSIONS – CASE SIZE A

Bottom View inches (mm)

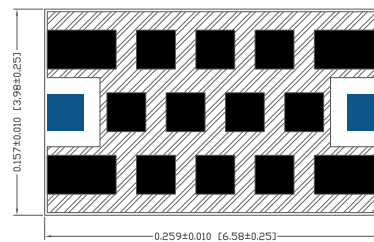

Typical Frequency Response

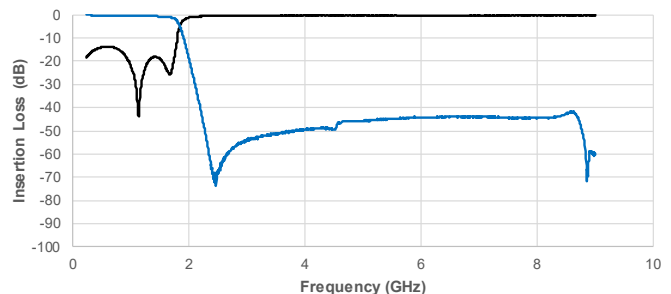

Multilayer Organic (MLO®) Filters

MLO® Low Pass Filters

LP0AA1620A7**

ELECTRICAL SPECIFICATIONS

Pass Band	DC - 1.620 GHz	1.2 dB	Max
	DC - 1.620 GHz	0.7 dB	Typ
	3dB Cutoff	1.87 GHz	Typ
Rejection	2.15 - 7.00 GHz	30dB	Min
	2.19 - 6.00 GHz	40dB	Min
Dimension	Thickness	40 Mils	Max
RF Power	Power	4 Watts	Max

[Click here to return to main table.](#)



**CLICK HERE TO DOWNLOAD
DATA FILES**

*Data files contain DXF and S2P files

DIMENSIONS – CASE SIZE A

Bottom View

inches (mm)

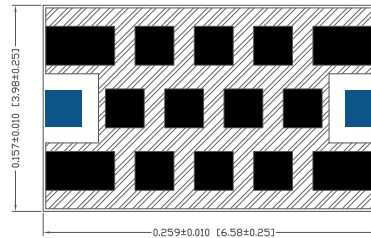

Typical Frequency Response

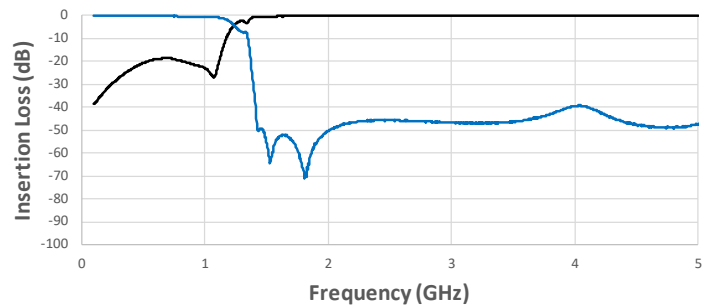

LP0AA1630A7**

ELECTRICAL SPECIFICATIONS

Pass Band	DC - 1.630 GHz	1.2 dB	Max
	DC - 1.630 GHz	0.7 dB	Typ
	3dB Cutoff	1.91 GHz	Typ
Rejection	2.18 - 8.00 GHz	30dB	Min
	2.22 - 3.00 GHz	40dB	Min
Dimension	Thickness	40 Mils	Max
RF Power	Power	4 Watts	Max

[Click here to return to main table.](#)



**CLICK HERE TO DOWNLOAD
DATA FILES**

*Data files contain DXF and S2P files

DIMENSIONS – CASE SIZE A

Bottom View

inches (mm)

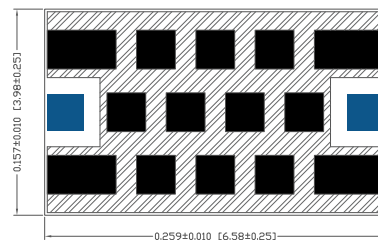

Typical Frequency Response

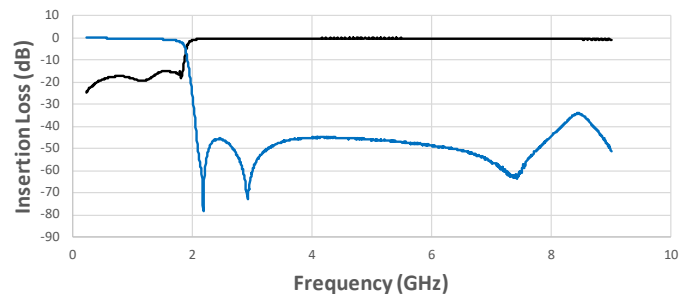

Multilayer Organic (MLO®) Filters

MLO® Low Pass Filters

LP0AA1670A7**

ELECTRICAL SPECIFICATIONS

Pass Band	DC - 1.670 GHz	1.2 dB	Max
	DC - 1.670 GHz	0.7 dB	Typ
	3dB Cutoff	2.00 GHz	Typ
Rejection	2.30 - 8.00 GHz	30dB	Min
	2.36 - 7.00 GHz	40dB	Min
Dimension	Thickness	40 Mils	Max
RF Power	Power	4 Watts	Max

[Click here to return to main table.](#)

 **CLICK HERE TO DOWNLOAD DATA FILES**

*Data files contain DXF and S2P files

DIMENSIONS – CASE SIZE A

Bottom View inches (mm)

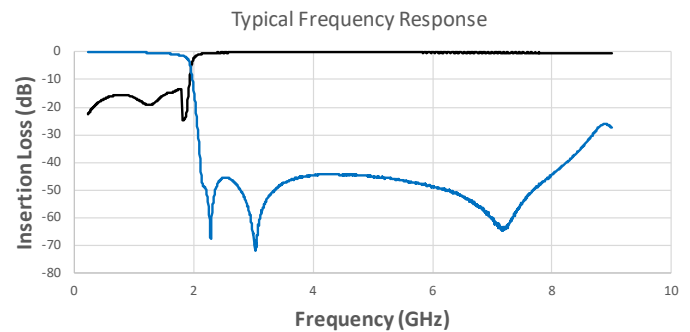
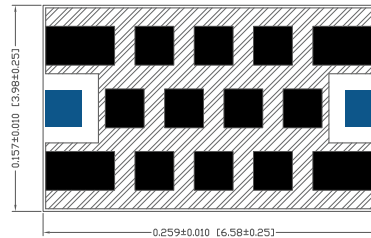

LP2EA1680A7**

ELECTRICAL SPECIFICATIONS

Pass Band	DC - 1.680 GHz	1.2 dB	Max
	DC - 1.680 GHz	0.8 dB	Typ
	3dB Cutoff	1.86 GHz	Typ
Rejection	2.18 - 9.00 GHz	30dB	Min
	2.22 - 4.00 GHz	40dB	Min
Dimension	Thickness	40 Mils	Max
RF Power	Power	4 Watts	Max

[Click here to return to main table.](#)

 **CLICK HERE TO DOWNLOAD DATA FILES**

*Data files contain DXF and S2P files

DIMENSIONS – CASE SIZE 2E

Bottom View inches (mm)

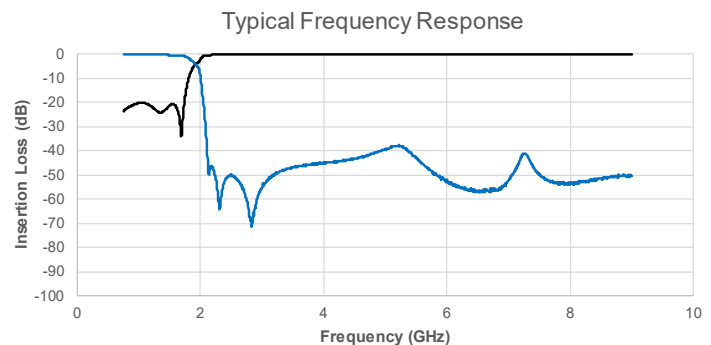
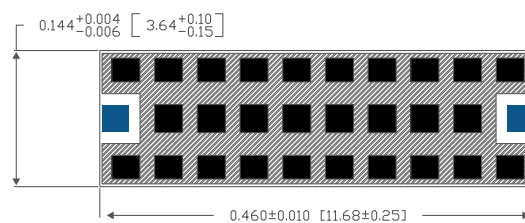

Multilayer Organic (MLO®) Filters

MLO® Low Pass Filters

LP0AA1680A7**

ELECTRICAL SPECIFICATIONS

Pass Band	DC - 1.680 GHz	1.2 dB	Max
	DC - 1.680 GHz	0.7 dB	Typ
	3dB Cutoff	2.01 GHz	Typ
Rejection	2.32 - 8.00 GHz	30dB	Min
	2.38 - 7.00 GHz	40dB	Min
Dimension	Thickness	40 Mils	Max
	RF Power	Power	4 Watts
			Max

[Click here to return to main table.](#)



**CLICK HERE TO DOWNLOAD
DATA FILES**

*Data files contain DXF and S2P files

DIMENSIONS – CASE SIZE A

Bottom View inches (mm)

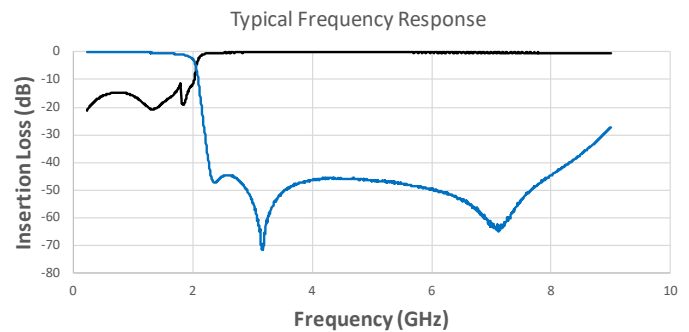
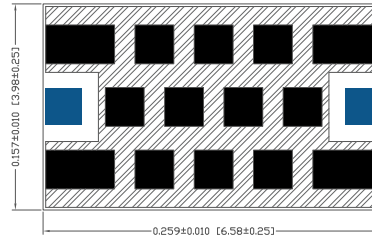

LP2EA1770A7**

ELECTRICAL SPECIFICATIONS

Pass Band	DC - 1.770 GHz	1.2 dB	Max
	DC - 1.770 GHz	0.8 dB	Typ
	3dB Cutoff	1.97 GHz	Typ
Rejection	2.33 - 5.00 GHz	30dB	Min
	2.37 - 4.50 GHz	40dB	Min
Dimension	Thickness	40 Mils	Max
	RF Power	Power	4 Watts
			Max

[Click here to return to main table.](#)



**CLICK HERE TO DOWNLOAD
DATA FILES**

*Data files contain DXF and S2P files

DIMENSIONS – CASE SIZE 2E

Bottom View inches (mm)

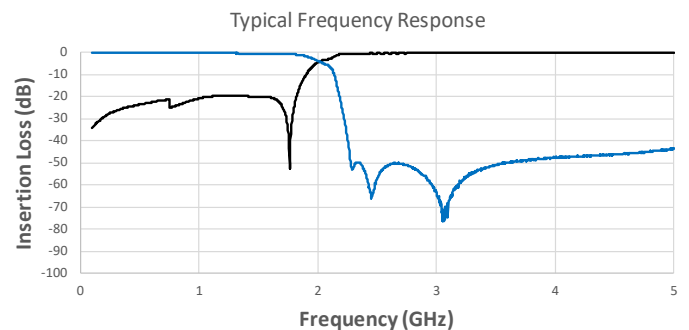
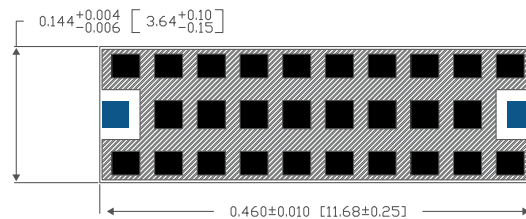

Multilayer Organic (MLO®) Filters

MLO® Low Pass Filters

LP0DA1780A7**

ELECTRICAL SPECIFICATIONS

Pass Band	DC - 1.780 GHz	1.2 dB	Max
	DC - 1.780 GHz	0.9 dB	Typ
	3dB Cutoff	1.97 GHz	Typ
Rejection	2.27 - 5.00 GHz	30dB	Min
	2.35 - 4.00 GHz	40dB	Min
Dimension	Thickness	40 Mils	Max
RF Power	Power	4 Watts	Max

[Click here to return to main table.](#)

 **CLICK HERE TO DOWNLOAD DATA FILES**

*Data files contain DXF and S2P files

DIMENSIONS – CASE SIZE D

Bottom View inches (mm)

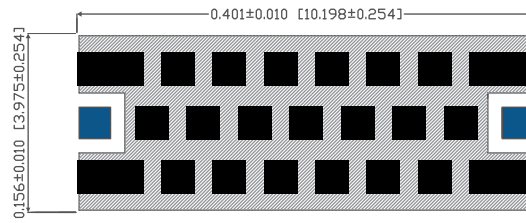

Typical Frequency Response

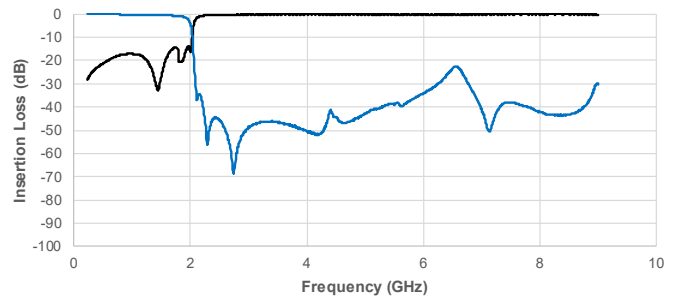

LP0DA1800A7**

ELECTRICAL SPECIFICATIONS

Pass Band	DC - 1.800 GHz	1.2 dB	Max
	DC - 1.800 GHz	0.8 dB	Typ
	3dB Cutoff	2.02 GHz	Typ
Rejection	2.30 - 6.00 GHz	30dB	Min
	2.40 - 4.00 GHz	40dB	Min
Dimension	Thickness	40Mils	Max
RF Power	Power	4 Watts	Max

[Click here to return to main table.](#)

 **CLICK HERE TO DOWNLOAD DATA FILES**

*Data files contain DXF and S2P files

DIMENSIONS – CASE SIZE D

Bottom View inches (mm)

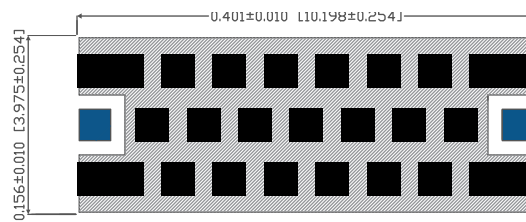

Typical Frequency Response

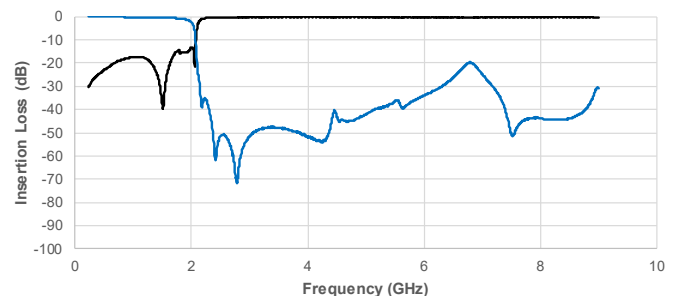

Multilayer Organic (MLO®) Filters

MLO® Low Pass Filters

LP0DA1810A7**

ELECTRICAL SPECIFICATIONS

Pass Band	DC - 1.810 GHz	1.2 dB	Max
	DC - 1.810 GHz	0.8 dB	Typ
	3dB Cutoff	2.04 GHz	Typ
Rejection	2.29 - 6.00 GHz	30dB	Min
	2.48 - 4.00 GHz	40dB	Min
Dimension	Thickness	40 Mils	Max
RF Power	Power	4 Watts	Max

[Click here to return to main table.](#)

 **CLICK HERE TO DOWNLOAD DATA FILES**

*Data files contain DXF and S2P files

DIMENSIONS – CASE SIZE D

Bottom View inches (mm)

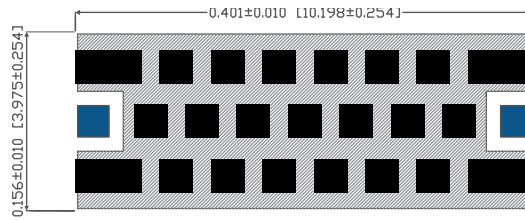

Typical Frequency Response

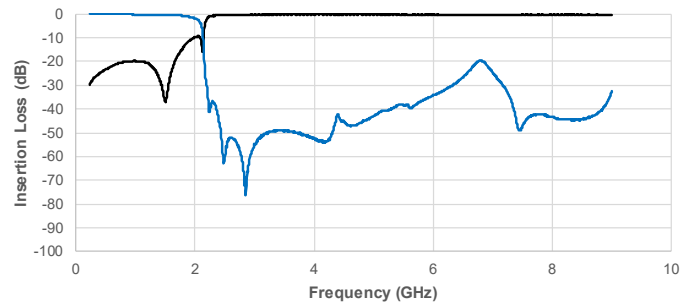

LP0DA1840A7**

ELECTRICAL SPECIFICATIONS

Pass Band	DC - 1.840 GHz	1.2 dB	Max
	DC - 1.840 GHz	0.7 dB	Typ
	3dB Cutoff	2.04 GHz	Typ
Rejection	2.27 - 5.50 GHz	30dB	Min
	2.44 - 4.00 GHz	40dB	Min
Dimension	Thickness	40Mils	Max
RF Power	Power	4 Watts	Max

[Click here to return to main table.](#)

 **CLICK HERE TO DOWNLOAD DATA FILES**

*Data files contain DXF and S2P files

DIMENSIONS – CASE SIZE D

Bottom View inches (mm)

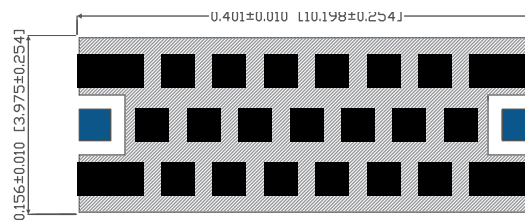

Typical Frequency Response

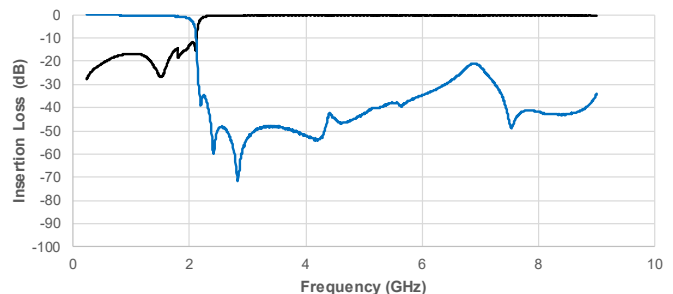

Multilayer Organic (MLO®) Filters

MLO® Low Pass Filters

LP0DA1880A7**

ELECTRICAL SPECIFICATIONS

Pass Band	DC - 1.880 GHz	1.2 dB	Max
	DC - 1.880 GHz	0.8 dB	Typ
	3dB Cutoff	2.05 GHz	Typ
Rejection	2.28 - 6.00 GHz	30dB	Min
	2.42 - 4.00 GHz	40dB	Min
Dimension	Thickness	40 Mils	Max
RF Power	Power	4 Watts	Max

[Click here to return to main table.](#)

 **CLICK HERE TO DOWNLOAD DATA FILES**

*Data files contain DXF and S2P files

DIMENSIONS – CASE SIZE D

Bottom View

inches (mm)

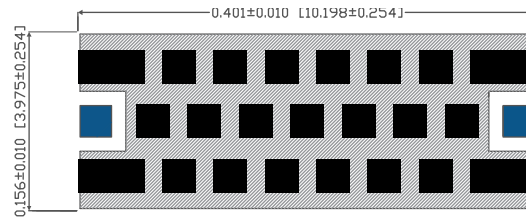

Typical Frequency Response

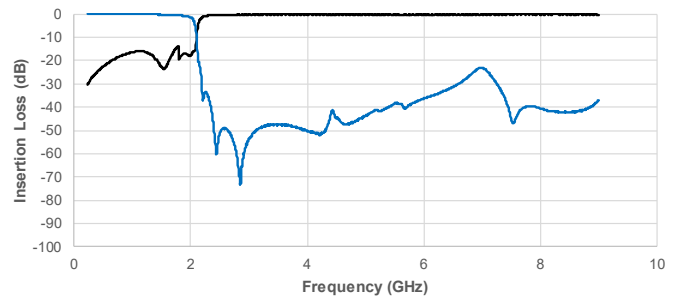

LP0DA1890A7**

ELECTRICAL SPECIFICATIONS

Pass Band	DC - 1.890 GHz	1.2 dB	Max
	DC - 1.890 GHz	0.8 dB	Typ
	3dB Cutoff	2.13 GHz	Typ
Rejection	2.38 - 7.00 GHz	30dB	Min
	- GHz	40dB	Min
Dimension	Thickness	40 Mils	Max
RF Power	Power	4 Watts	Max

[Click here to return to main table.](#)

 **CLICK HERE TO DOWNLOAD DATA FILES**

*Data files contain DXF and S2P files

DIMENSIONS – CASE SIZE D

Bottom View

inches (mm)

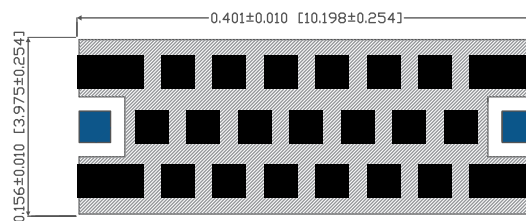

Typical Frequency Response

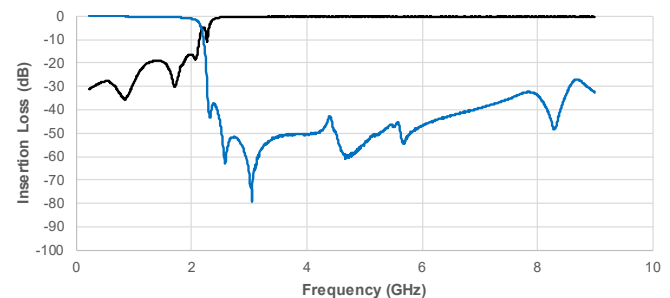

Multilayer Organic (MLO®) Filters

MLO® Low Pass Filters

LP0DA1950A7**

ELECTRICAL SPECIFICATIONS

Pass Band	DC - 1.950 GHz	1.2 dB	Max
	DC - 1.950 GHz	0.8 dB	Typ
	3dB Cutoff	2.20 GHz	Typ
Rejection	2.53 - 8.00 GHz	30dB	Min
	- GHz	40dB	Min
Dimension	Thickness	40 Mils	Max
RF Power	Power	4 Watts	Max

[Click here to return to main table.](#)

 **CLICK HERE TO DOWNLOAD DATA FILES**

*Data files contain DXF and S2P files

DIMENSIONS – CASE SIZE D

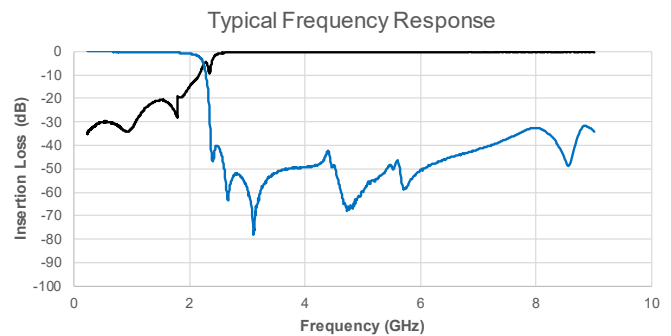
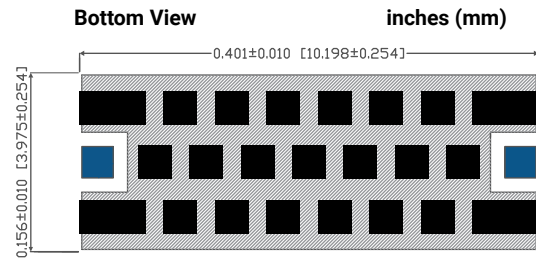

LP0DA2100A7**

ELECTRICAL SPECIFICATIONS

Pass Band	DC - 2.100 GHz	1.2 dB	Max
	DC - 2.100 GHz	0.8 dB	Typ
	3dB Cutoff	2.37 GHz	Typ
Rejection	2.68 - 9.00 GHz	30dB	Min
	2.72 - 5.11 GHz	40dB	Min
Dimension	Thickness	22 Mils	Max
RF Power	Power	4 Watts	Max

[Click here to return to main table.](#)

 **CLICK HERE TO DOWNLOAD DATA FILES**

*Data files contain DXF and S2P files

DIMENSIONS – CASE SIZE D

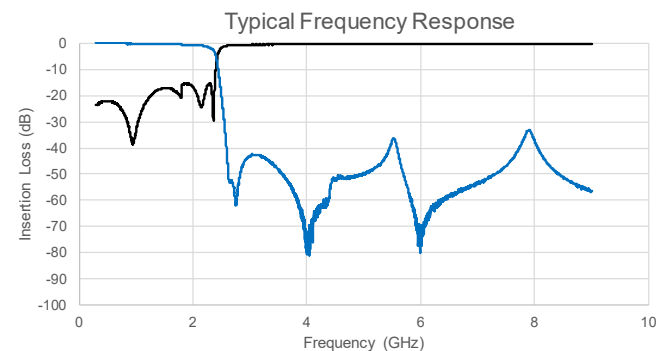
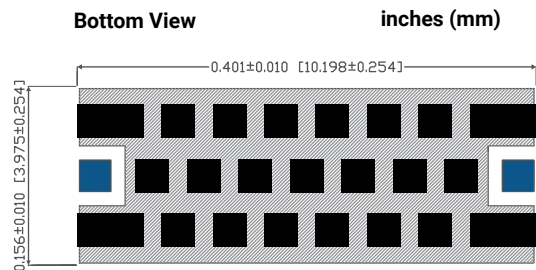

Multilayer Organic (MLO®) Filters

MLO® Low Pass Filters

LP0DA2140A7**

ELECTRICAL SPECIFICATIONS

Pass Band	DC - 2.140 GHz	1.2 dB	Max
	DC - 2.140 GHz	0.7 dB	Typ
	3dB Cutoff	2.38 GHz	Typ
Rejection	2.68 - 9.00 GHz	30dB	Min
	2.72 - 5.23 GHz	40dB	Min
Dimension	Thickness	22 Mils	Max
RF Power	Power	4 Watts	Max

[Click here to return to main table.](#)



**CLICK HERE TO DOWNLOAD
DATA FILES**

*Data files contain DXF and S2P files

DIMENSIONS – CASE SIZE D

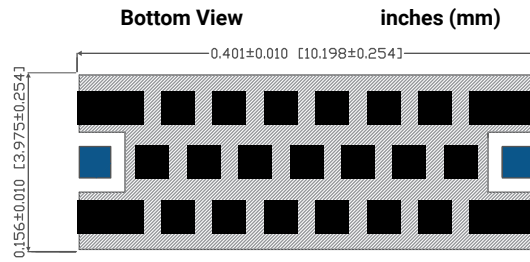

Typical Frequency Response

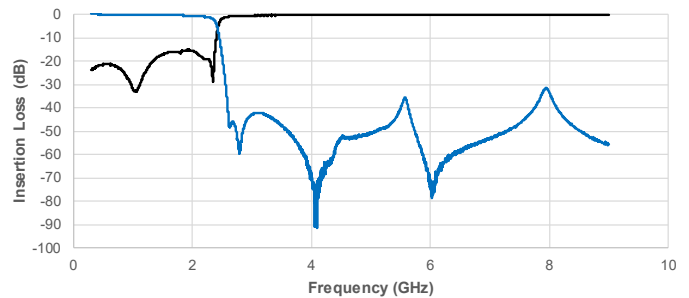

LP0DA2160A7**

ELECTRICAL SPECIFICATIONS

Pass Band	DC - 2.160 GHz	1.2 dB	Max
	DC - 2.160 GHz	0.8 dB	Typ
	3dB Cutoff	2.41 GHz	Typ
Rejection	2.72 - 5.00 GHz	30dB	Min
	- GHz	40dB	Min
Dimension	Thickness	22 Mils	Max
RF Power	Power	4 Watts	Max

[Click here to return to main table.](#)



**CLICK HERE TO DOWNLOAD
DATA FILES**

*Data files contain DXF and S2P files

DIMENSIONS – CASE SIZE D

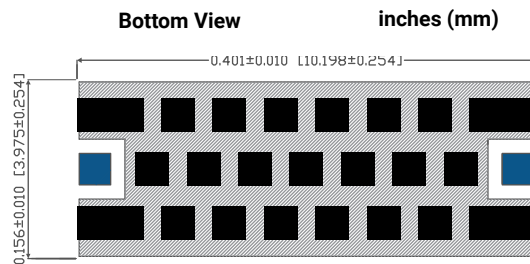

Typical Frequency Response

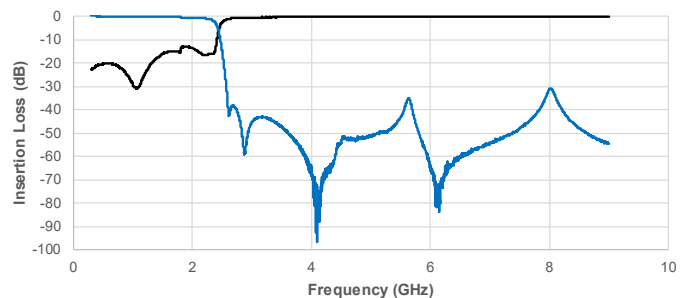

Multilayer Organic (MLO®) Filters

MLO® Low Pass Filters

LP0DA2190A7**

ELECTRICAL SPECIFICATIONS

Pass Band	DC - 2.190 GHz	1.2 dB	Max
	DC - 2.190 GHz	0.6 dB	Typ
	3dB Cutoff	2.44 GHz	Typ
Rejection	2.79 - 6.50 GHz	30dB	Min
	2.93 - 4.00 GHz	40dB	Min
Dimension	Thickness	40 Mils	Max
RF Power	Power	4 Watts	Max

[Click here to return to main table.](#)

 **CLICK HERE TO DOWNLOAD DATA FILES**

*Data files contain DXF and S2P files

DIMENSIONS – CASE SIZE D

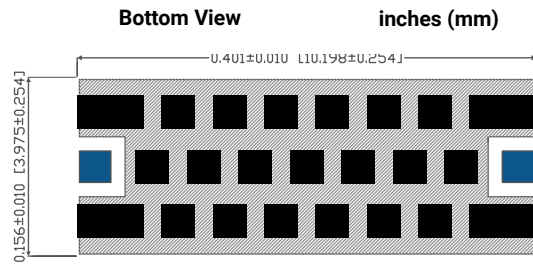

Typical Frequency Response

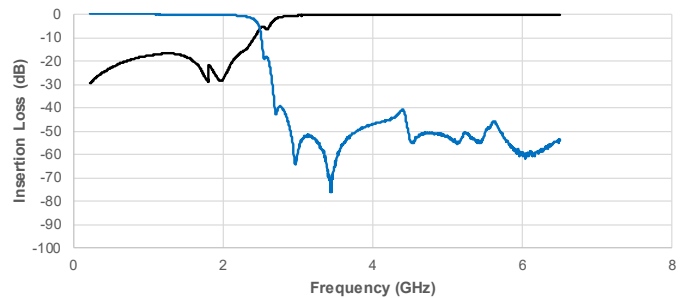

LP0DA2200A7**

ELECTRICAL SPECIFICATIONS

Pass Band	DC - 2.200 GHz	1.2 dB	Max
	DC - 2.200 GHz	0.8 dB	Typ
	3dB Cutoff	2.50 GHz	Typ
Rejection	2.84 - 5.00 GHz	30dB	Min
	4.00 - 5.00 GHz	40dB	Min
Dimension	Thickness	22 Mils	Max
RF Power	Power	4 Watts	Max

[Click here to return to main table.](#)

 **CLICK HERE TO DOWNLOAD DATA FILES**

*Data files contain DXF and S2P files

DIMENSIONS – CASE SIZE D

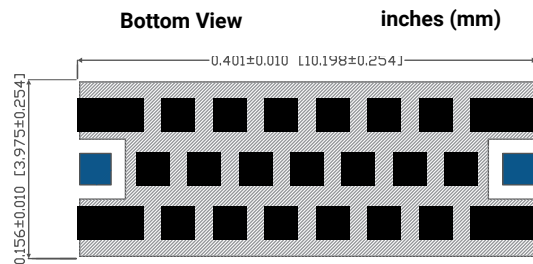

Typical Frequency Response

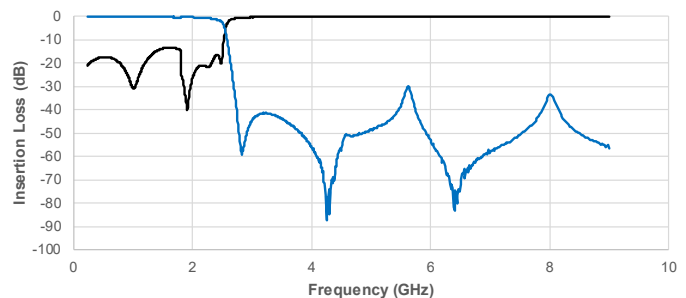

Multilayer Organic (MLO®) Filters

MLO® Low Pass Filters

LP0DA2210A7**

ELECTRICAL SPECIFICATIONS

Pass Band	DC - 2.210 GHz	1.2 dB	Max
	DC - 2.210 GHz	0.8 dB	Typ
	3dB Cutoff	2.60 GHz	Typ
Rejection	2.98 - 8.50 GHz	30dB	Min
	3.25 - 4.25 GHz	40dB	Min
Dimension	Thickness	40 Mils	Max
RF Power	Power	4 Watts	Max

[Click here to return to main table.](#)

 **CLICK HERE TO DOWNLOAD DATA FILES**

*Data files contain DXF and S2P files

DIMENSIONS – CASE SIZE D

Bottom View inches (mm)

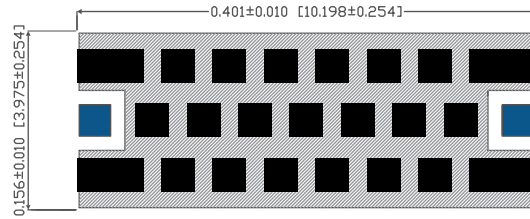

Typical Frequency Response

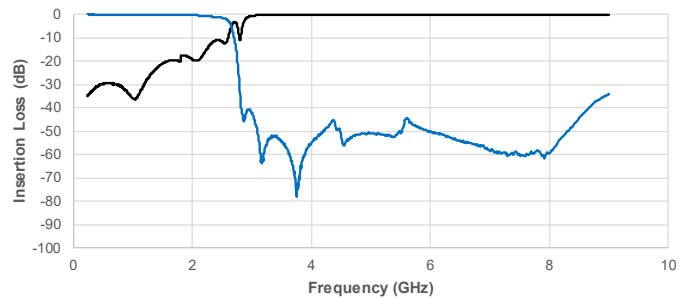

LP0DA2260A7**

ELECTRICAL SPECIFICATIONS

Pass Band	DC - 2.260 GHz	1.2 dB	Max
	DC - 2.260 GHz	0.8 dB	Typ
	3dB Cutoff	2.50 GHz	Typ
Rejection	2.86 - 5.00 GHz	30dB	Min
	4.00 - 5.00 GHz	40dB	Min
Dimension	Thickness	22 Mils	Max
RF Power	Power	4 Watts	Max

[Click here to return to main table.](#)

 **CLICK HERE TO DOWNLOAD DATA FILES**

*Data files contain DXF and S2P files

DIMENSIONS – CASE SIZE D

Bottom View inches (mm)

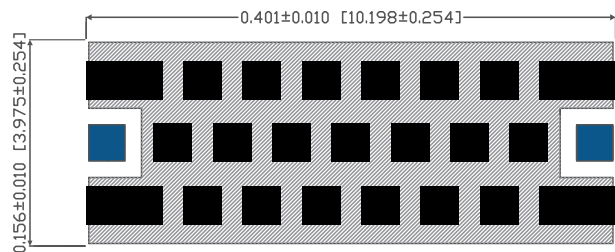

Typical Frequency Response

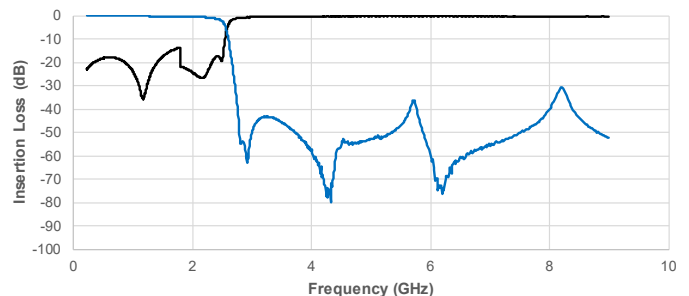

Multilayer Organic (MLO®) Filters

MLO® Low Pass Filters

LP0AA2300A7**

ELECTRICAL SPECIFICATIONS

Pass Band	DC - 2.300 GHz	1.2 dB	Max
	DC - 2.300 GHz	0.9 dB	Typ
	3dB Cutoff	2.56 GHz	Typ
Rejection	3.15 - 9.00 GHz	30dB	Min
	3.26 - 9.00 GHz	40dB	Min
Dimension	Thickness	22 Mils	Max
RF Power	Power	4 Watts	Max

[Click here to return to main table.](#)



**CLICK HERE TO DOWNLOAD
DATA FILES**

*Data files contain DXF and S2P files

DIMENSIONS – CASE SIZE A

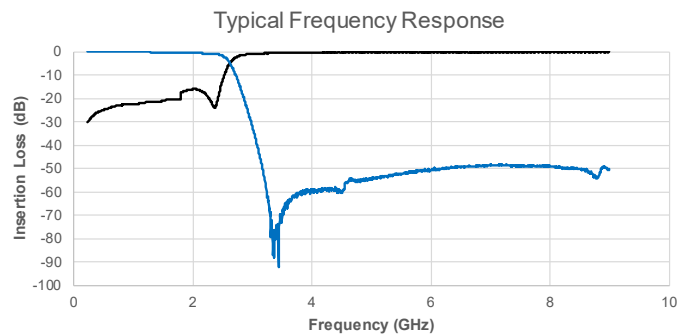
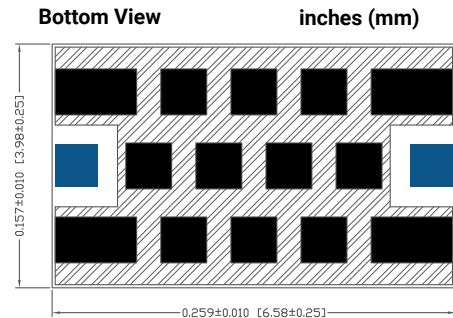

LP0AA2490A7**

ELECTRICAL SPECIFICATIONS

Pass Band	DC - 2.490 GHz	1.2 dB	Max
	DC - 2.490 GHz	0.7 dB	Typ
	3dB Cutoff	2.80 GHz	Typ
Rejection	3.98 - 9.00 GHz	30dB	Min
	3.79 - 5.00 GHz	40dB	Min
Dimension	Thickness	40 Mils	Max
RF Power	Power	4 Watts	Max

[Click here to return to main table.](#)



**CLICK HERE TO DOWNLOAD
DATA FILES**

*Data files contain DXF and S2P files

DIMENSIONS – CASE SIZE A

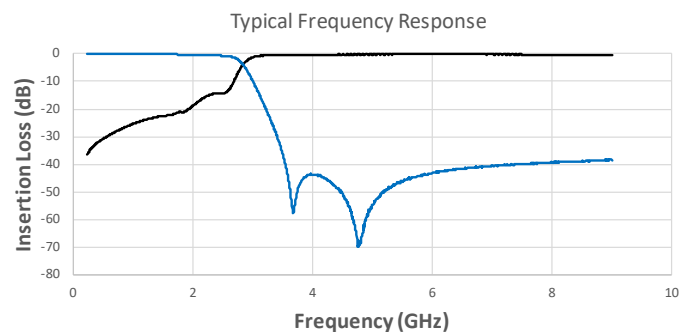
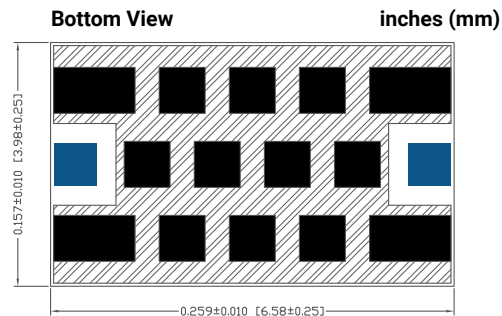

Multilayer Organic (MLO®) Filters

MLO® Low Pass Filters



LP2EA2530A7**

ELECTRICAL SPECIFICATIONS

Pass Band	DC - 2.530 GHz	1.2 dB	Max
	DC - 2.530 GHz	0.7 dB	Typ
	3dB Cutoff	2.87 GHz	Typ
Rejection	3.28 - 9.00 GHz	30dB	Min
	3.32 - 6.50 GHz	40dB	Min
Dimension	Thickness	40 Mils	Max
RF Power	Power	4 Watts	Max

[Click here to return to main table.](#)



CLICK HERE TO DOWNLOAD DATA FILES

*Data files contain DXF and S2P files

DIMENSIONS – CASE SIZE 2E

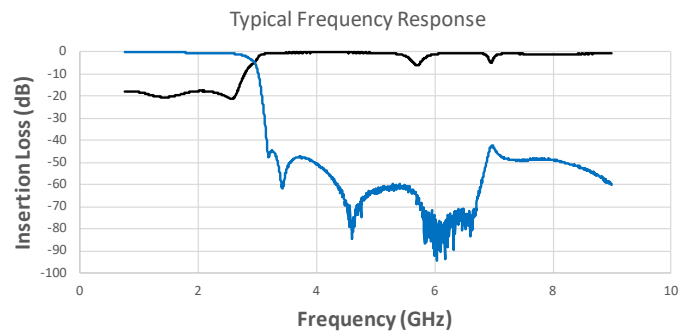
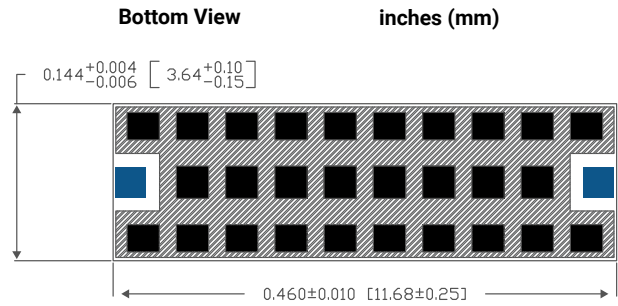

LP0AA2590A7**

ELECTRICAL SPECIFICATIONS

Pass Band	DC - 2.590 GHz	1.2 dB	Max
	DC - 2.590 GHz	0.7 dB	Typ
	3dB Cutoff	2.89 GHz	Typ
Rejection	3.71 - 9.00 GHz	30dB	Min
	3.87 - 5.20 GHz	40dB	Min
Dimension	Thickness	40 Mils	Max
RF Power	Power	4 Watts	Max

[Click here to return to main table.](#)



CLICK HERE TO DOWNLOAD DATA FILES

*Data files contain DXF and S2P files

DIMENSIONS – CASE SIZE A

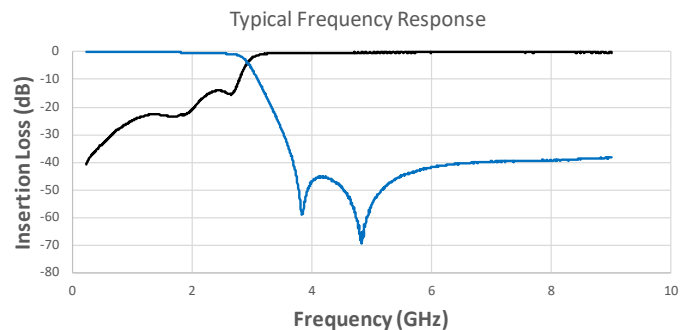
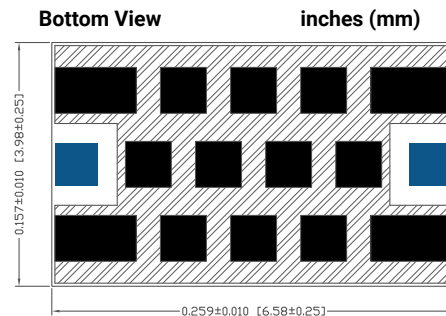

Multilayer Organic (MLO®) Filters

MLO® Low Pass Filters

LP2EA2600A7**

ELECTRICAL SPECIFICATIONS

Pass Band	DC - 2.600 GHz	1.2 dB	Max
	DC - 2.600 GHz	0.7 dB	Typ
	3dB Cutoff	2.95 GHz	Typ
Rejection	3.40 - 9.00 GHz	30dB	Min
	3.50 - 6.00 GHz	40dB	Min
Dimension	Thickness	40 Mils	Max
RF Power	Power	4 Watts	Max

[Click here to return to main table.](#)



**CLICK HERE TO DOWNLOAD
DATA FILES**

*Data files contain DXF and S2P files

DIMENSIONS – CASE SIZE 2E

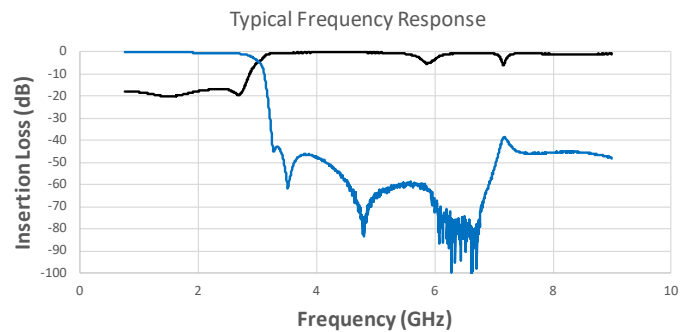
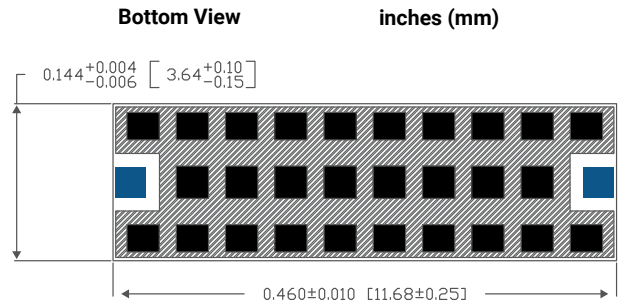

LP0AA2640A7**

ELECTRICAL SPECIFICATIONS

Pass Band	DC - 2.640 GHz	1.2 dB	Max
	DC - 2.640 GHz	0.8 dB	Typ
	3dB Cutoff	2.97 GHz	Typ
Rejection	3.82 - 9.00 GHz	30dB	Min
	3.98 - 5.50 GHz	40dB	Min
Dimension	Thickness	40 Mils	Max
RF Power	Power	4 Watts	Max

[Click here to return to main table.](#)



**CLICK HERE TO DOWNLOAD
DATA FILES**

*Data files contain DXF and S2P files

DIMENSIONS – CASE SIZE A

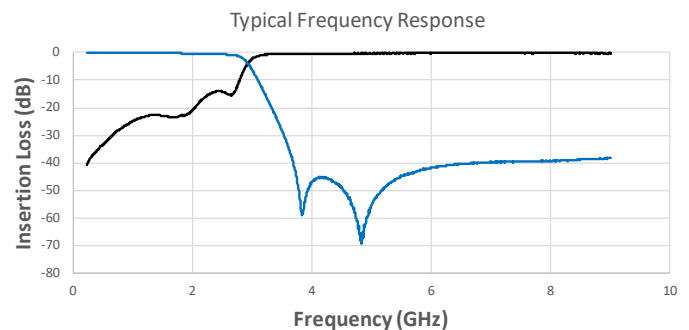
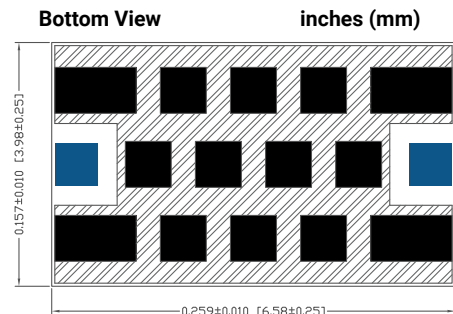

Multilayer Organic (MLO®) Filters

MLO® Low Pass Filters

LP0AA2910A7**

ELECTRICAL SPECIFICATIONS

Pass Band	DC - 2.910 GHz	1.2 dB	Max
	DC - 2.910 GHz	0.8 dB	Typ
	3dB Cutoff	3.43 GHz	Typ
Rejection	4.07 - 9.00 GHz	30dB	Min
	4.80 - 8.00 GHz	40dB	Min
Dimension	Thickness	22 Mils	Max
RF Power	Power	4 Watts	Max

[Click here to return to main table.](#)

 **CLICK HERE TO DOWNLOAD DATA FILES**

*Data files contain DXF and S2P files

DIMENSIONS – CASE SIZE A

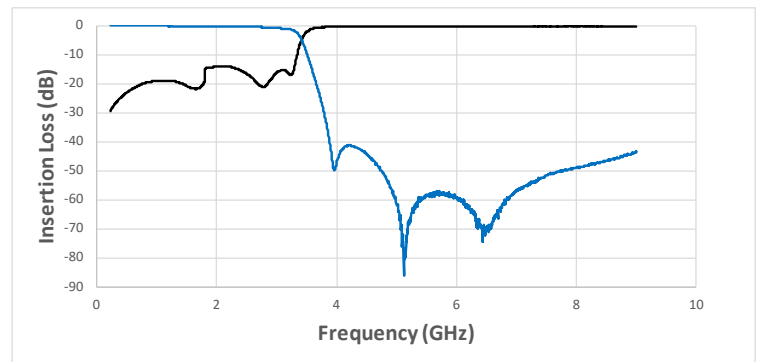
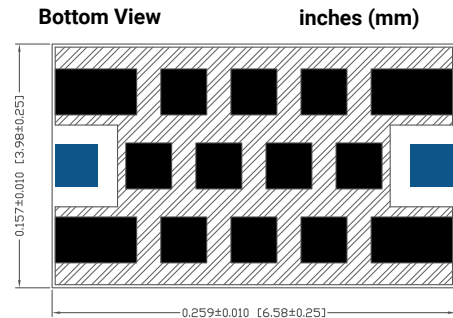

LP0AA2980A7**

ELECTRICAL SPECIFICATIONS

Pass Band	DC - 2.980 GHz	1.2 dB	Max
	DC - 2.980 GHz	0.7 dB	Typ
	3dB Cutoff	3.52 GHz	Typ
Rejection	4.17 - 9.00 GHz	30dB	Min
	4.29 - 8.00 GHz	40dB	Min
Dimension	Thickness	22 Mils	Max
RF Power	Power	4 Watts	Max

[Click here to return to main table.](#)

 **CLICK HERE TO DOWNLOAD DATA FILES**

*Data files contain DXF and S2P files

DIMENSIONS – CASE SIZE A

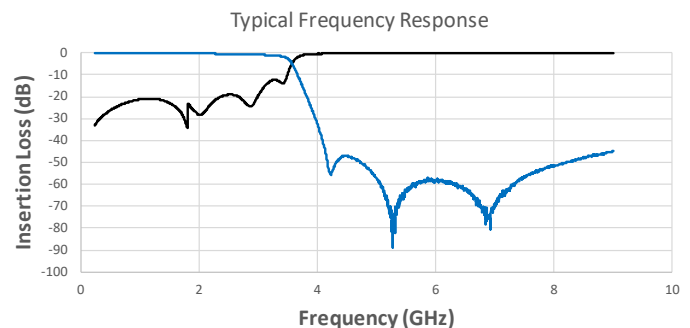
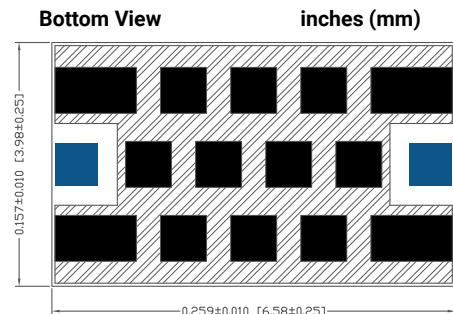

Multilayer Organic (MLO®) Filters

MLO® Low Pass Filters

LP0AA3100A7**

ELECTRICAL SPECIFICATIONS

Pass Band	DC - 3.100 GHz	1.2 dB	Max
	DC - 3.100 GHz	0.7 dB	Typ
	3dB Cutoff	3.65 GHz	Typ
Rejection	4.32 - 9.00 GHz	30dB	Min
	5.00 - 8.00 GHz	40dB	Min
Dimension	Thickness	22 Mils	Max
RF Power	Power	4 Watts	Max

[Click here to return to main table.](#)

 **CLICK HERE TO DOWNLOAD DATA FILES**

*Data files contain DXF and S2P files

DIMENSIONS – CASE SIZE A

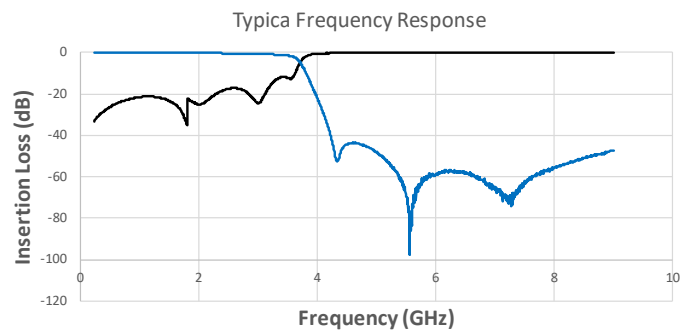
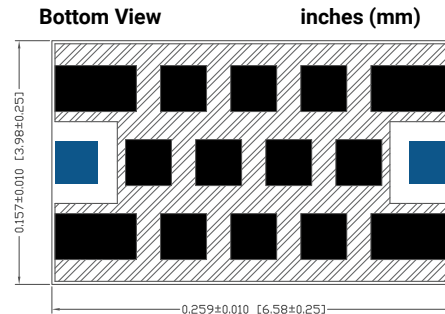

LP0AA3160A7**

ELECTRICAL SPECIFICATIONS

Pass Band	DC - 3.160 GHz	1.2 dB	Max
	DC - 3.160 GHz	0.8 dB	Typ
	3dB Cutoff	3.47 GHz	Typ
Rejection	4.36 - 9.00 GHz	30dB	Min
	4.47 - 9.00 GHz	40dB	Min
Dimension	Thickness	22 Mils	Max
RF Power	Power	4 Watts	Max

[Click here to return to main table.](#)

 **CLICK HERE TO DOWNLOAD DATA FILES**

*Data files contain DXF and S2P files

DIMENSIONS – CASE SIZE A

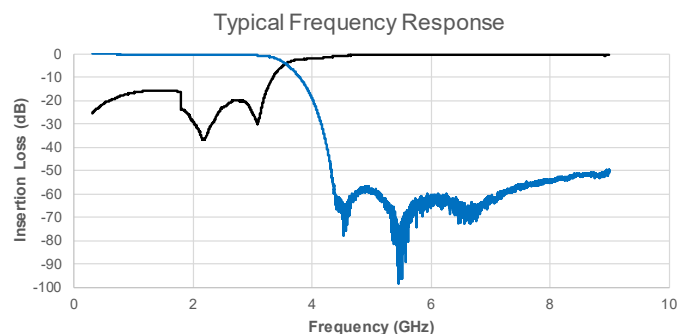
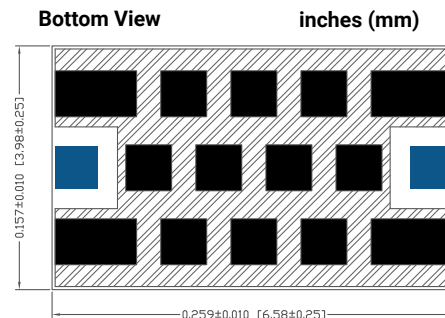

Multilayer Organic (MLO®) Filters

MLO® Low Pass Filters

LP0AA4080A7**

ELECTRICAL SPECIFICATIONS

Pass Band	DC - 4.080 GHz	1.2 dB	Max
	DC - 4.080 GHz	0.7 dB	Typ
	3dB Cutoff	5.03 GHz	Typ
Rejection	5.62 - 9.00 GHz	30dB	Min
	5.69 - 9.00 GHz	40dB	Min
Dimension	Thickness	22 Mils	Max
RF Power	Power	4 Watts	Max

[Click here to return to main table.](#)



**CLICK HERE TO DOWNLOAD
DATA FILES**

*Data files contain DXF and S2P files

DIMENSIONS – CASE SIZE A

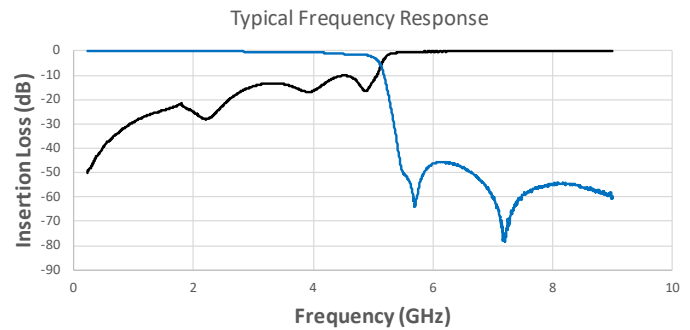
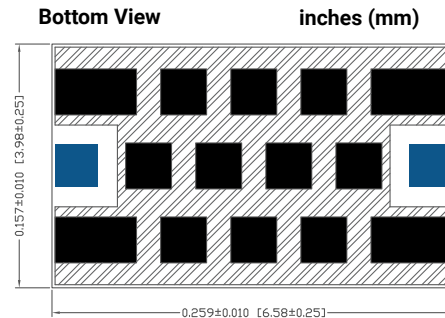

LP0AA4150A7**

ELECTRICAL SPECIFICATIONS

Pass Band	DC - 4.150 GHz	1.2 dB	Max
	DC - 4.150 GHz	0.6 dB	Typ
	3dB Cutoff	5.16 GHz	Typ
Rejection	5.75 - 9.00 GHz	30dB	Min
	5.82 - 9.00 GHz	40dB	Min
Dimension	Thickness	22 Mils	Max
RF Power	Power	4 Watts	Max

[Click here to return to main table.](#)



**CLICK HERE TO DOWNLOAD
DATA FILES**

*Data files contain DXF and S2P files

DIMENSIONS – CASE SIZE A

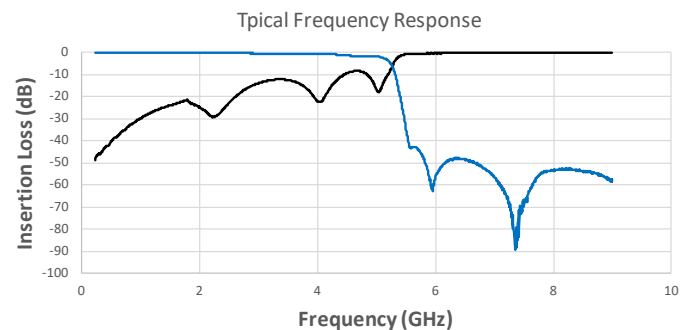
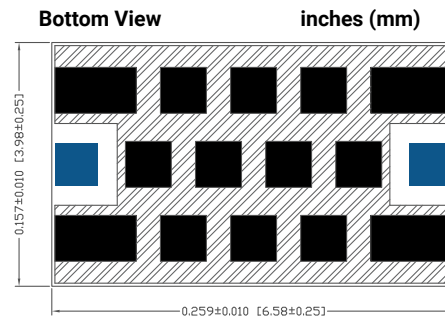

Multilayer Organic (MLO®) Filters

MLO® Low Pass Filters

LP0AA4210A7**

ELECTRICAL SPECIFICATIONS

Pass Band	DC - 4.210 GHz	1.2 dB	Max
	DC - 4.210 GHz	0.7 dB	Typ
	3dB Cutoff	5.28 GHz	Typ
Rejection	5.87 - 9.00 GHz	30dB	Min
	6.16 - 9.00 GHz	40dB	Min
Dimension	Thickness	22 Mils	Max
RF Power	Power	4 Watts	Max

[Click here to return to main table.](#)



**CLICK HERE TO DOWNLOAD
DATA FILES**

*Data files contain DXF and S2P files

DIMENSIONS – CASE SIZE A

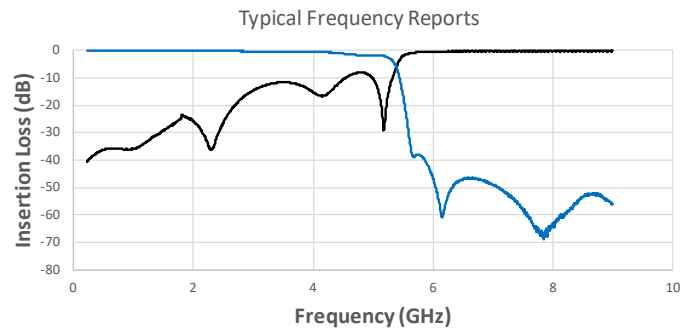
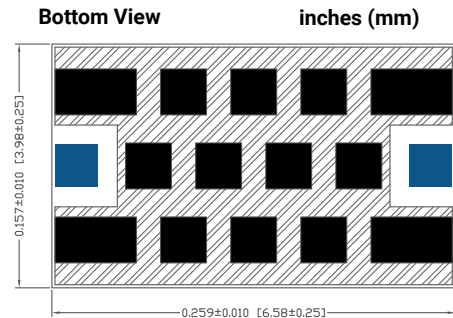

LP0AA4370A7**

ELECTRICAL SPECIFICATIONS

Pass Band	DC - 4.370 GHz	1.2 dB	Max
	DC - 7.370 GHz	0.8 dB	Typ
	3dB Cutoff	4.84 GHz	Typ
Rejection	6.00 - 9.00 GHz	30dB	Min
	6.32 - 9.00 GHz	40dB	Min
Dimension	Thickness	22 Mils	Max
RF Power	Power	4 Watts	Max

[Click here to return to main table.](#)



**CLICK HERE TO DOWNLOAD
DATA FILES**

*Data files contain DXF and S2P files

DIMENSIONS – CASE SIZE A

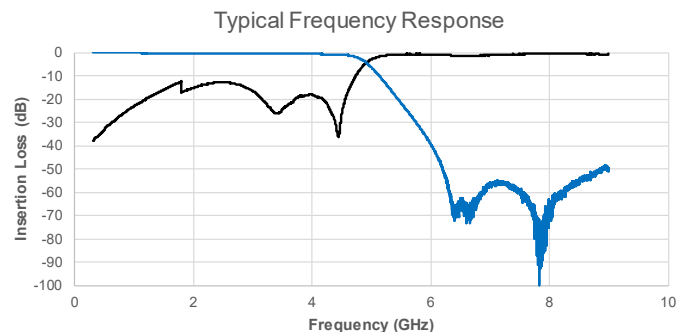
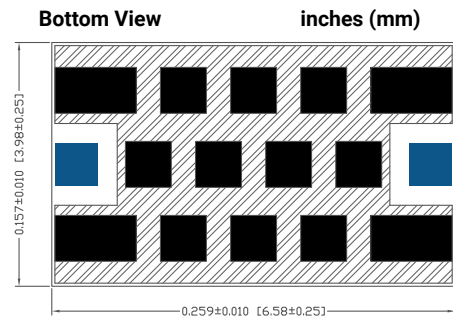

Multilayer Organic (MLO®) Filters

MLO® Low Pass Filters

LP0AA6160A7**

ELECTRICAL SPECIFICATIONS

Pass Band	DC - 6.160 GHz	1.2 dB	Max
	DC - 6.160 GHz	0.9 dB	Typ
	3dB Cutoff	7.09 GHz	Typ
Rejection	8.59 - 13.00 GHz	30dB	Min
	8.82 - 11.50 GHz	40dB	Min
Dimension	Thickness	22 Mils	Max
RF Power	Power	4 Watts	Max

[Click here to return to main table.](#)



**CLICK HERE TO DOWNLOAD
DATA FILES**

*Data files contain DXF and S2P files

DIMENSIONS – CASE SIZE A

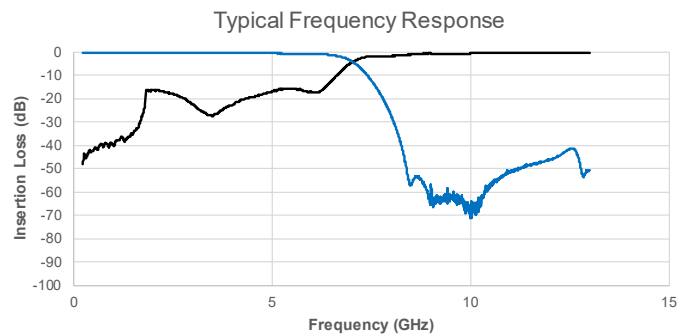
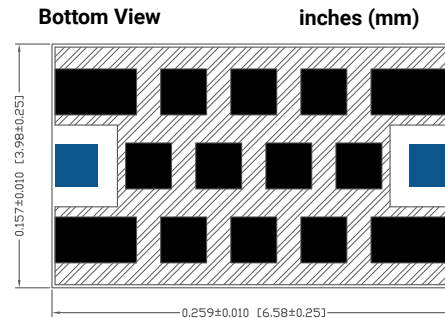

LP0FA0054A7**

ELECTRICAL SPECIFICATIONS

Pass Band	DC - 0.054 GHz	1.2 dB	Max
	DC - 0.054 GHz	0.9 dB	Typ
	-3dB Cutoff	0.071 GHz	Typ
Rejection	0.083 - 0.7 GHz	30 dB	Min
	N/A	40 dB	Min
Dimension	Thickness	40 Mils	Max
RF Power	Power	4 Watts	Max

[Click here to return to main table.](#)



**CLICK HERE TO DOWNLOAD
DATA FILES**

*Data files contain DXF and S2P files

DIMENSIONS – CASE SIZE F

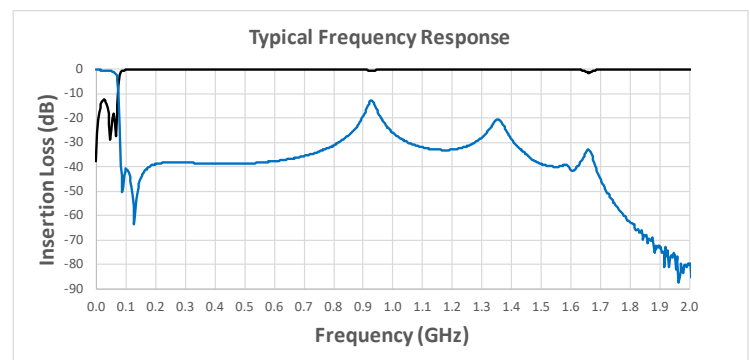
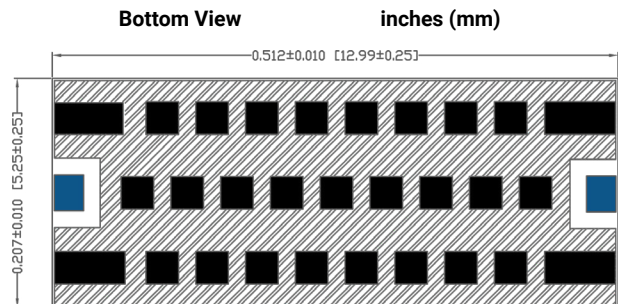

Multilayer Organic (MLO®) Filters

MLO® Low Pass Filters

LP0FA0056A7**

ELECTRICAL SPECIFICATIONS

Pass Band	DC - 0.057 GHz	1.2 dB	Max
	DC - 0.057 GHz	0.9 dB	Typ
	-3dB Cutoff	0.072 GHz	Typ
Rejection	0.089 - 0.7 GHz	30 dB	Min
	N/A	40 dB	Min
Dimension	Thickness	40 Mils	Max
RF Power	Power	4 Watts	Max

[Click here to return to main table.](#)



**CLICK HERE TO DOWNLOAD
DATA FILES**

*Data files contain DXF and S2P files

DIMENSIONS – CASE SIZE F

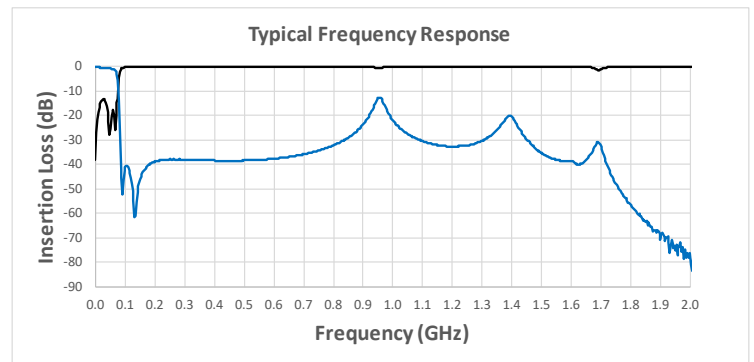
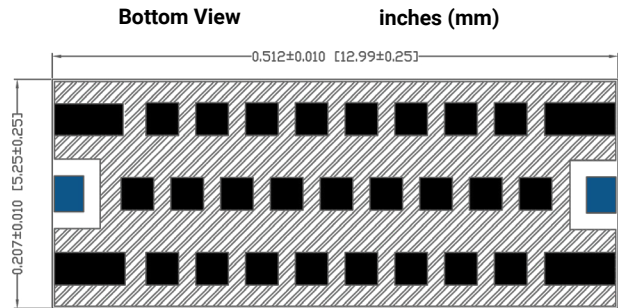

LP0FA0057A7**

ELECTRICAL SPECIFICATIONS

Pass Band	DC - 0.057 GHz	1.2 dB	Max
	DC - 0.057 GHz	0.9 dB	Typ
	-3dB Cutoff	0.073 GHz	Typ
Rejection	0.09 - 0.7 GHz	30 dB	Min
	N/A	40 dB	Min
Dimension	Thickness	40 Mils	Max
RF Power	Power	4 Watts	Max

[Click here to return to main table.](#)



**CLICK HERE TO DOWNLOAD
DATA FILES**

*Data files contain DXF and S2P files

DIMENSIONS – CASE SIZE F

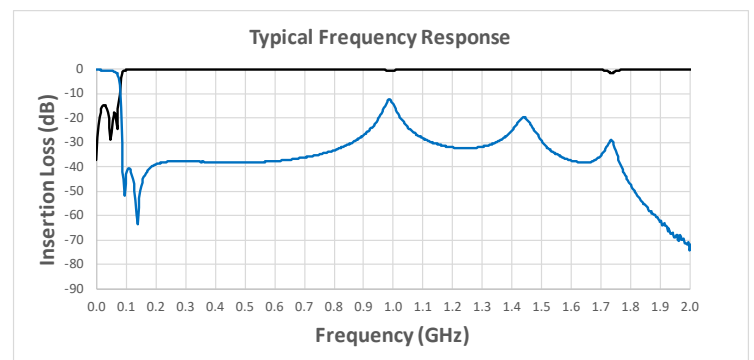
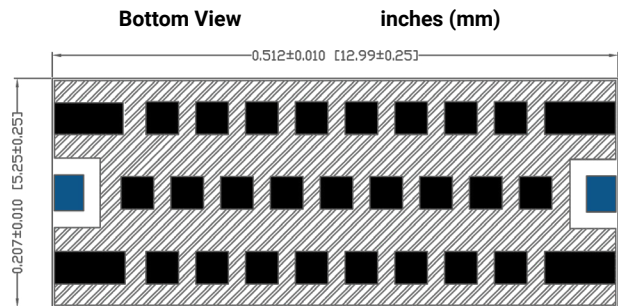

Multilayer Organic (MLO®) Filters

MLO® Low Pass Filters

LP0EA0076A7**

ELECTRICAL SPECIFICATIONS

Pass Band	DC - 0.076 GHz	1.2 dB	Max
	DC - 0.076 GHz	0.9 dB	Typ
	-3dB Cutoff	0.096 GHz	Typ
Rejection	0.115 - 0.8 GHz	30 dB	Min
	N/A	40 dB	Min
Dimension	Thickness	40 Mils	Max
RF Power	Power	4 Watts	Max

[Click here to return to main table.](#)



**CLICK HERE TO DOWNLOAD
DATA FILES**

*Data files contain DXF and S2P files

DIMENSIONS – CASE SIZE E

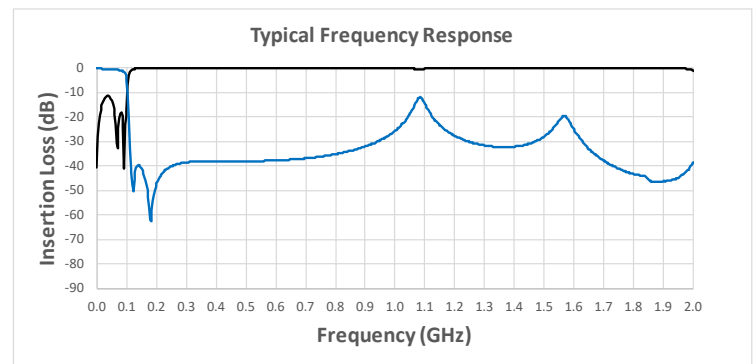
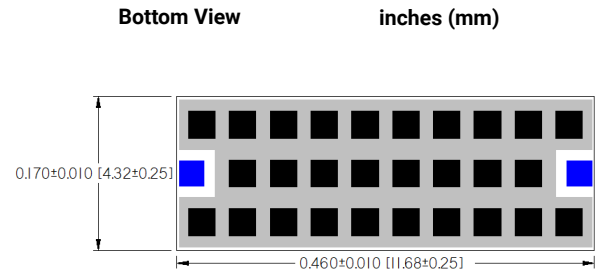

LP0EA0080A7**

ELECTRICAL SPECIFICATIONS

Pass Band	DC - 0.08 GHz	1.2 dB	Max
	DC - 0.08 GHz	0.9 dB	Typ
	-3dB Cutoff	0.102 GHz	Typ
Rejection	0.121 - 0.8 GHz	30 dB	Min
	N/A	40 dB	Min
Dimension	Thickness	40 Mils	Max
RF Power	Power	4 Watts	Max

[Click here to return to main table.](#)



**CLICK HERE TO DOWNLOAD
DATA FILES**

*Data files contain DXF and S2P files

DIMENSIONS – CASE SIZE E

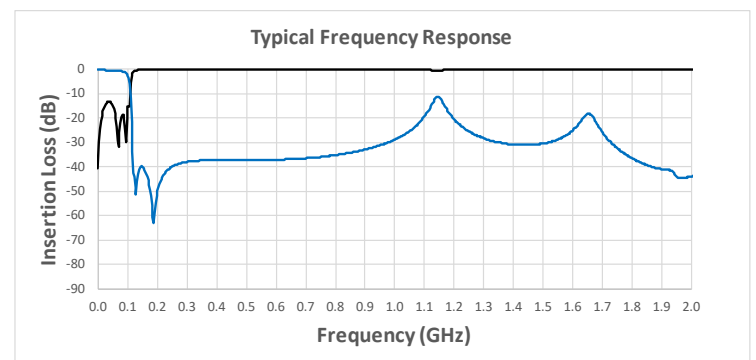
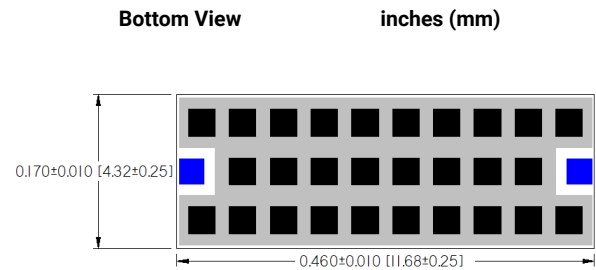

Multilayer Organic (MLO®) Filters

MLO® Low Pass Filters

LP0EA0082A7**

ELECTRICAL SPECIFICATIONS

Pass Band	DC - 0.082 GHz	1.2 dB	Max
	DC - 0.082 GHz	0.8 dB	Typ
	-3dB Cutoff	0.105 GHz	Typ
Rejection	0.125 - 0.8 GHz	30 dB	Min
	N/A	40 dB	Min
Dimension	Thickness	40 Mils	Max
RF Power	Power	4 Watts	Max

[Click here to return to main table.](#)



**CLICK HERE TO DOWNLOAD
DATA FILES**

*Data files contain DXF and S2P files

DIMENSIONS – CASE SIZE E

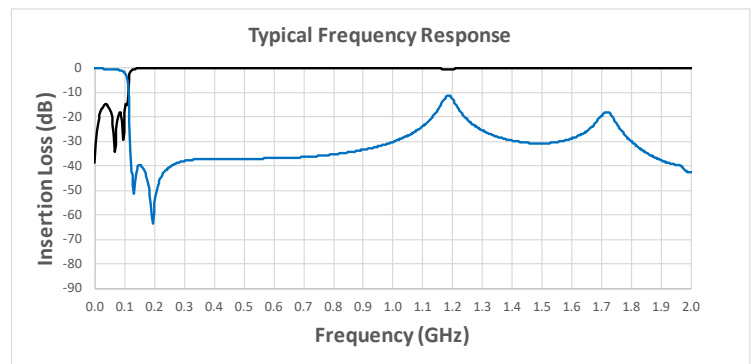
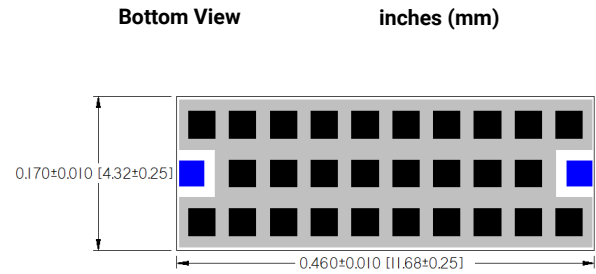

LP0DA0102A7**

ELECTRICAL SPECIFICATIONS

Pass Band	DC - 0.102 GHz	1.2 dB	Max
	DC - 0.102 GHz	0.9 dB	Typ
	-3dB Cutoff	0.132 GHz	Typ
Rejection	0.155 - 0.9 GHz	30 dB	Min
	N/A	40 dB	Min
Dimension	Thickness	40 Mils	Max
RF Power	Power	4 Watts	Max

[Click here to return to main table.](#)



**CLICK HERE TO DOWNLOAD
DATA FILES**

*Data files contain DXF and S2P files

DIMENSIONS – CASE SIZE D

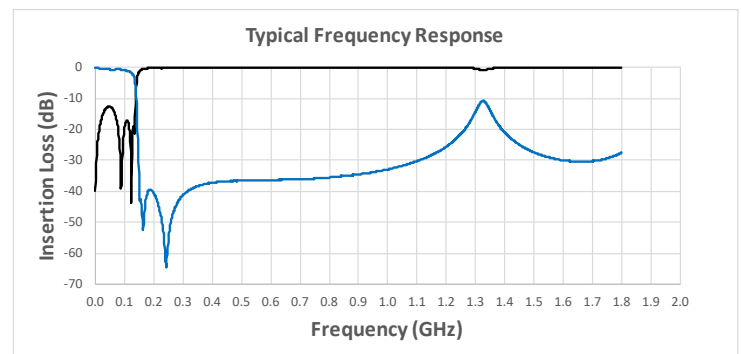
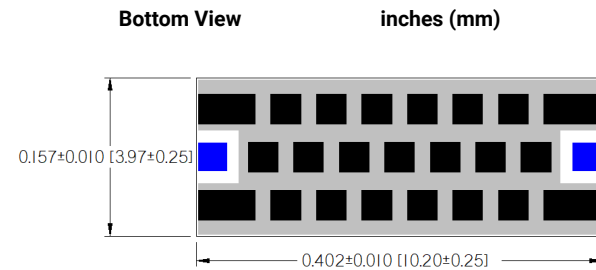

Multilayer Organic (MLO®) Filters

MLO® Low Pass Filters

LP0DA0107A7**

ELECTRICAL SPECIFICATIONS

Pass Band	DC - 0.107 GHz	1.2 dB	Max
	DC - 0.107 GHz	0.9 dB	Typ
	-3dB Cutoff	0.136 GHz	Typ
Rejection	0.16 - 0.9 GHz	30 dB	Min
	N/A	40 dB	Min
Dimension	Thickness	40 Mils	Max
RF Power	Power	4 Watts	Max

[Click here to return to main table.](#)



CLICK HERE TO DOWNLOAD DATA FILES

*Data files contain DXF and S2P files

DIMENSIONS – CASE SIZE D

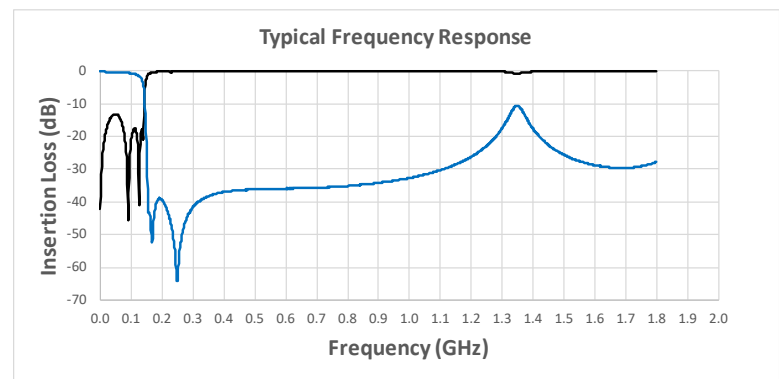
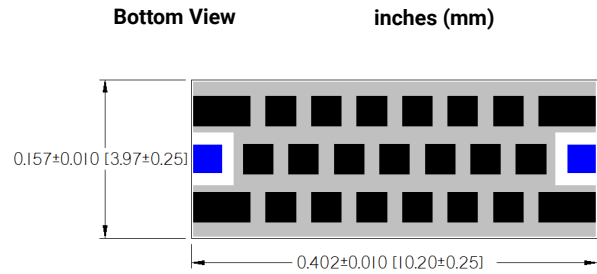

LP0DA0112A7**

ELECTRICAL SPECIFICATIONS

Pass Band	DC - 0.112 GHz	1.2 dB	Max
	DC - 0.112 GHz	0.9 dB	Typ
	-3dB Cutoff	0.143 GHz	Typ
Rejection	0.167 - 0.9 GHz	30 dB	Min
	N/A	40 dB	Min
Dimension	Thickness	40 Mils	Max
RF Power	Power	4 Watts	Max

[Click here to return to main table.](#)



CLICK HERE TO DOWNLOAD DATA FILES

*Data files contain DXF and S2P files

DIMENSIONS – CASE SIZE D

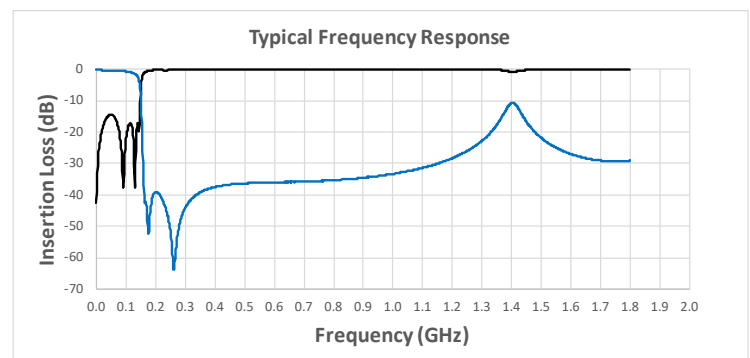
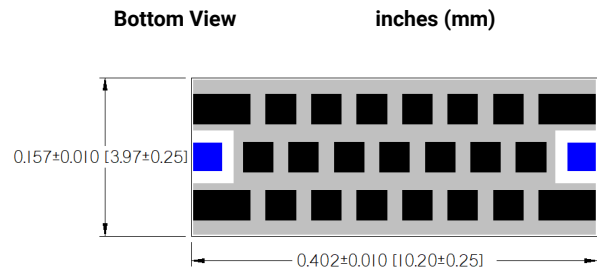

Multilayer Organic (MLO®) Filters

MLO® Low Pass Filters

LP0AA0141A7**

ELECTRICAL SPECIFICATIONS

Pass Band	DC - 0.141 GHz	1.2 dB	Max
	DC - 0.141 GHz	0.8 dB	Typ
	-3dB Cutoff	0.172 GHz	Typ
Rejection	0.212 - 2 GHz	30 dB	Min
	N/A	40 dB	Min
Dimension	Thickness	40 Mils	Max
RF Power	Power	4 Watts	Max

[Click here to return to main table.](#)



**CLICK HERE TO DOWNLOAD
DATA FILES**

*Data files contain DXF and S2P files

DIMENSIONS – CASE SIZE A

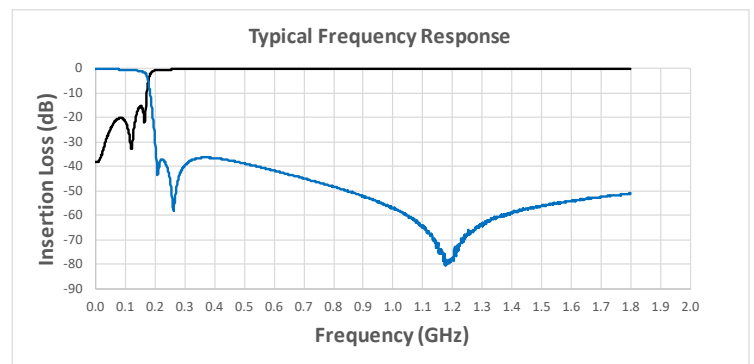
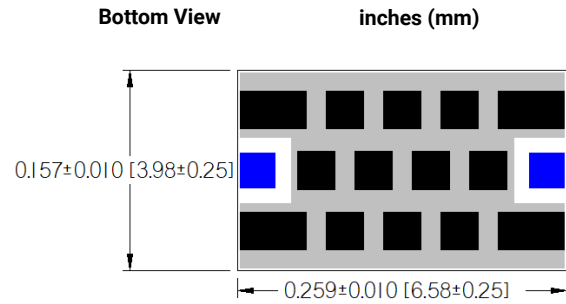

LP0AA0145A7**

ELECTRICAL SPECIFICATIONS

Pass Band	DC - 0.145 GHz	1.2 dB	Max
	DC - 0.145 GHz	0.9 dB	Typ
	-3dB Cutoff	0.174 GHz	Typ
Rejection	0.224 - 2 GHz	30 dB	Min
	N/A	40 dB	Min
Dimension	Thickness	40 Mils	Max
RF Power	Power	4 Watts	Max

[Click here to return to main table.](#)



**CLICK HERE TO DOWNLOAD
DATA FILES**

*Data files contain DXF and S2P files

DIMENSIONS – CASE SIZE A

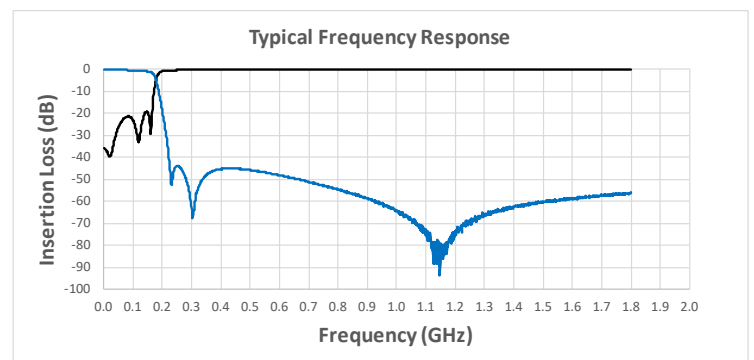
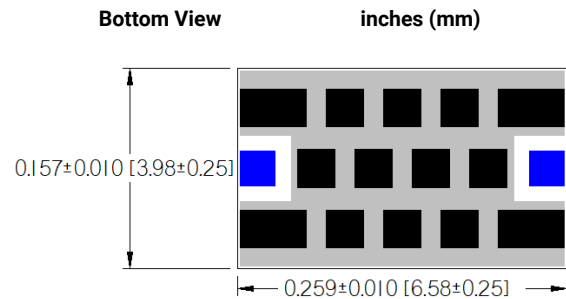

Multilayer Organic (MLO®) Filters

MLO® Low Pass Filters

LP0AA0149A7**

ELECTRICAL SPECIFICATIONS

Pass Band	DC - 0.149 GHz	1.2 dB	Max
	DC - 0.149 GHz	0.8 dB	Typ
	-3dB Cutoff	0.182 GHz	Typ
Rejection	0.224 - 2 GHz	30 dB	Min
	N/A	40 dB	Min
Dimension	Thickness	40 Mils	Max
RF Power	Power	4 Watts	Max

[Click here to return to main table.](#)



**CLICK HERE TO DOWNLOAD
DATA FILES**

*Data files contain DXF and S2P files

DIMENSIONS – CASE SIZE A

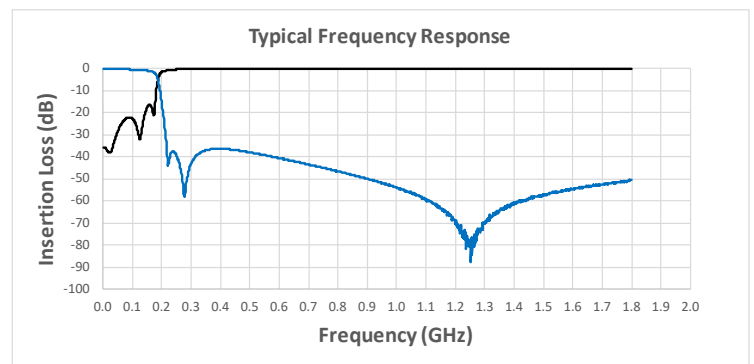
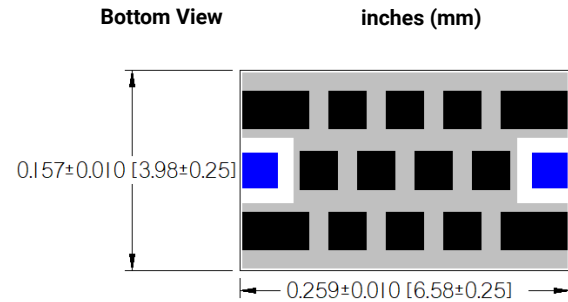

LP0AA0153A7**

ELECTRICAL SPECIFICATIONS

Pass Band	DC - 0.153 GHz	1.2 dB	Max
	DC - 0.153 GHz	0.8 dB	Typ
	-3dB Cutoff	0.189 GHz	Typ
Rejection	0.231 - 2 GHz	30 dB	Min
	N/A	40 dB	Min
Dimension	Thickness	40 Mils	Max
RF Power	Power	4 Watts	Max

[Click here to return to main table.](#)



**CLICK HERE TO DOWNLOAD
DATA FILES**

*Data files contain DXF and S2P files

DIMENSIONS – CASE SIZE A

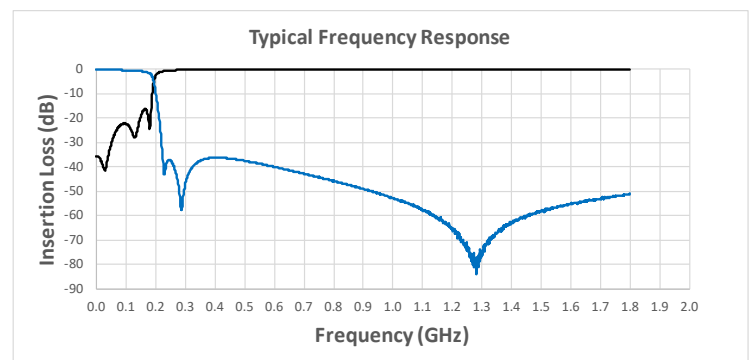
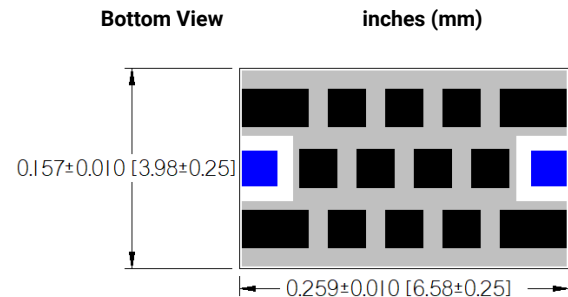

Multilayer Organic (MLO®) Filters

MLO® Low Pass Filters

LP0AA0156A7**

ELECTRICAL SPECIFICATIONS

Pass Band	DC - 0.156 GHz	1.2 dB	Max
	DC - 0.156 GHz	0.8 dB	Typ
	-3dB Cutoff	0.192 GHz	Typ
Rejection	0.236 - 2 GHz	30 dB	Min
	N/A	40 dB	Min
Dimension	Thickness	40 Mils	Max
RF Power	Power	4 Watts	Max

[Click here to return to main table.](#)



**CLICK HERE TO DOWNLOAD
DATA FILES**

*Data files contain DXF and S2P files

DIMENSIONS – CASE SIZE A

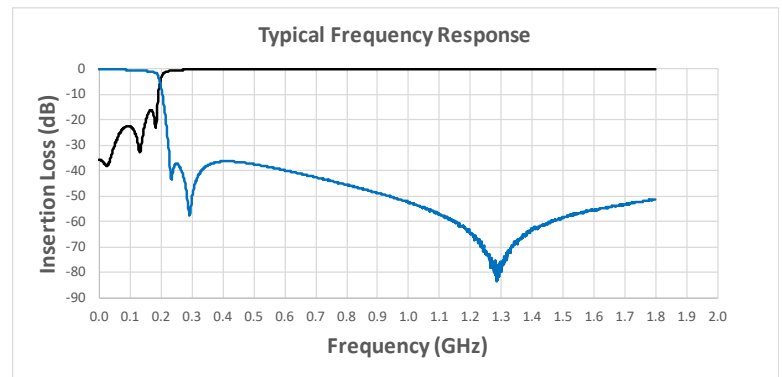
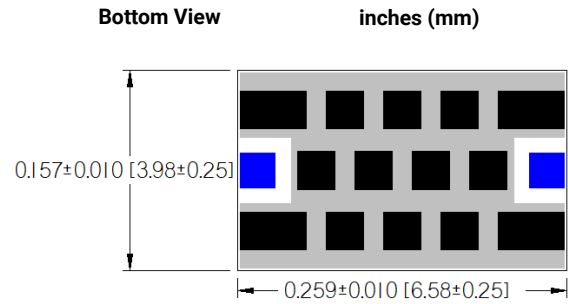

LP0AA0161A7**

ELECTRICAL SPECIFICATIONS

Pass Band	DC - 0.161 GHz	1.2 dB	Max
	DC - 0.161 GHz	0.8 dB	Typ
	-3dB Cutoff	0.197 GHz	Typ
Rejection	0.241 - 2 GHz	30 dB	Min
	N/A	40 dB	Min
Dimension	Thickness	40 Mils	Max
RF Power	Power	4 Watts	Max

[Click here to return to main table.](#)



**CLICK HERE TO DOWNLOAD
DATA FILES**

*Data files contain DXF and S2P files

DIMENSIONS – CASE SIZE A

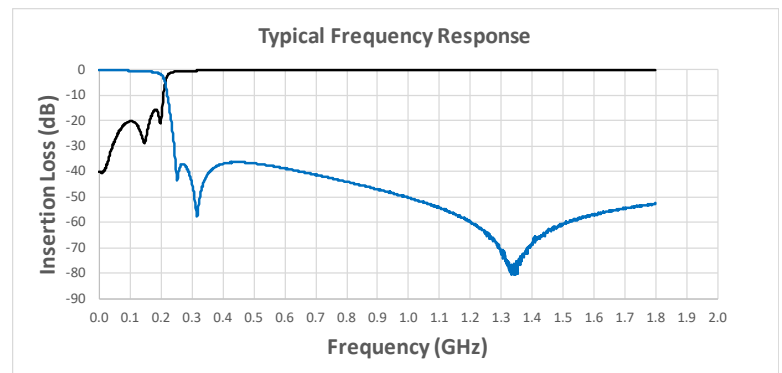
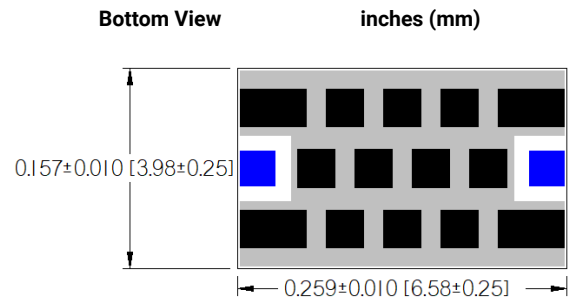

Multilayer Organic (MLO®) Filters

MLO® Low Pass Filters

LP0AA0171A7**

ELECTRICAL SPECIFICATIONS

Pass Band	DC - 0.171 GHz	1.2 dB	Max
	DC - 0.171 GHz	0.8 dB	Typ
	-3dB Cutoff	0.207 GHz	Typ
Rejection	0.255 - 2 GHz	30 dB	Min
	N/A	40 dB	Min
Dimension	Thickness	40 Mils	Max
RF Power	Power	4 Watts	Max

[Click here to return to main table.](#)



**CLICK HERE TO DOWNLOAD
DATA FILES**

*Data files contain DXF and S2P files

DIMENSIONS – CASE SIZE A

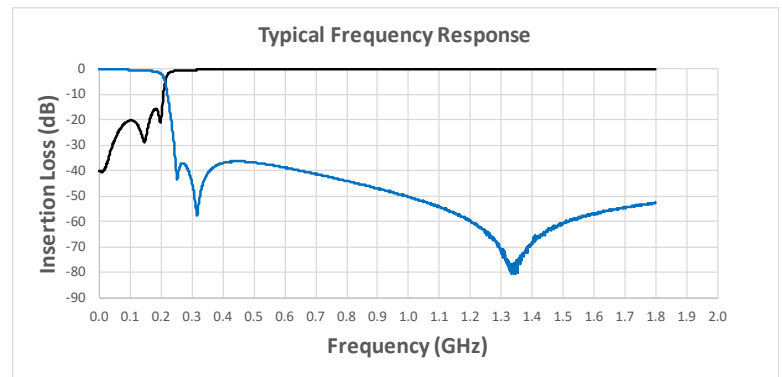
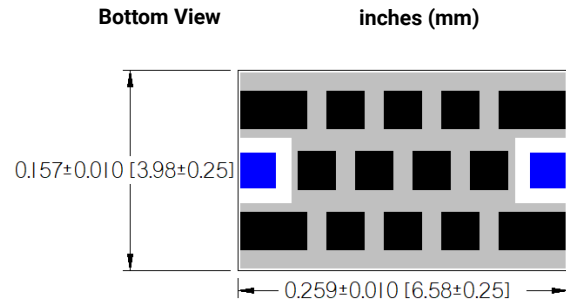

LP0AA0174A7**

ELECTRICAL SPECIFICATIONS

Pass Band	DC - 0.174 GHz	1.2 dB	Max
	DC - 0.174 GHz	0.8 dB	Typ
	-3dB Cutoff	0.212 GHz	Typ
Rejection	0.26 - 2 GHz	30 dB	Min
	N/A	40 dB	Min
Dimension	Thickness	40 Mils	Max
RF Power	Power	4 Watts	Max

[Click here to return to main table.](#)



**CLICK HERE TO DOWNLOAD
DATA FILES**

*Data files contain DXF and S2P files

DIMENSIONS – CASE SIZE A

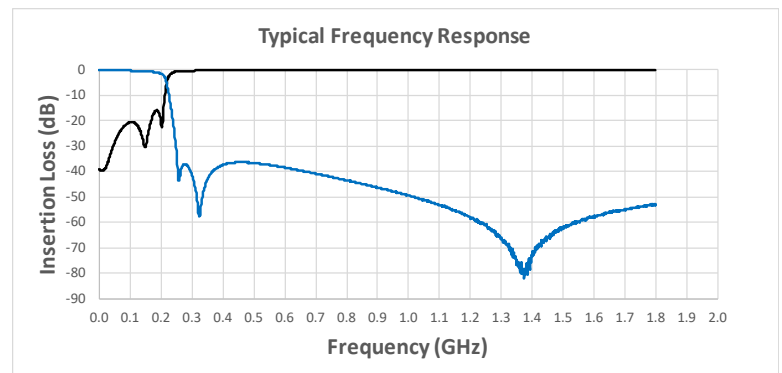
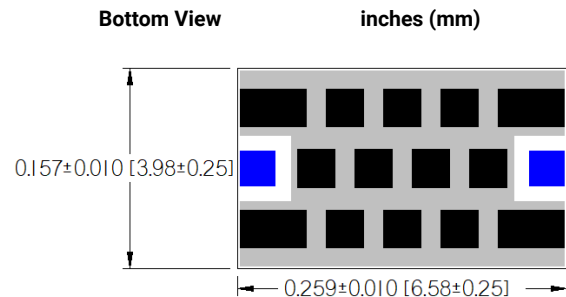

Multilayer Organic (MLO®) Filters

MLO® Low Pass Filters

LP0AA0185A7**

ELECTRICAL SPECIFICATIONS

Pass Band	DC - 0.185 GHz	1.2 dB	Max
	DC - 0.185 GHz	0.8 dB	Typ
	-3dB Cutoff	0.22 GHz	Typ
Rejection	0.27 - 2 GHz	30 dB	Min
	N/A	40 dB	Min
Dimension	Thickness	40 Mils	Max
RF Power	Power	4 Watts	Max

[Click here to return to main table.](#)



CLICK HERE TO DOWNLOAD DATA FILES

*Data files contain DXF and S2P files

DIMENSIONS – CASE SIZE A

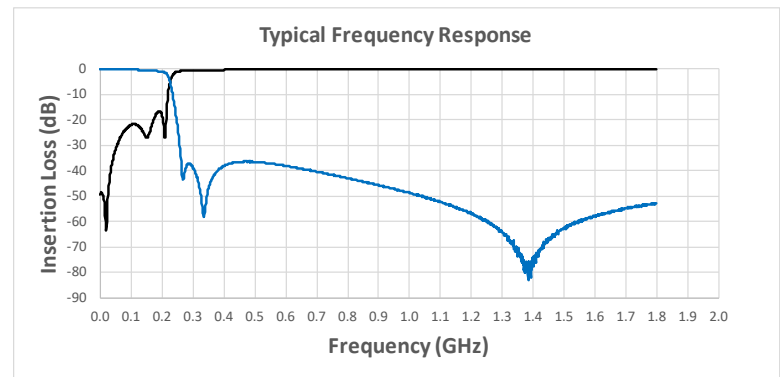
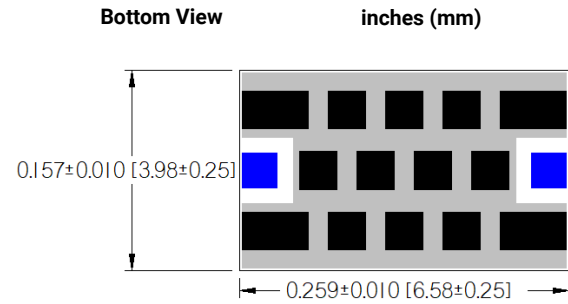

LP0AA0194A7**

ELECTRICAL SPECIFICATIONS

Pass Band	DC - 0.194 GHz	1.2 dB	Max
	DC - 0.194 GHz	0.8 dB	Typ
	-3dB Cutoff	0.241 GHz	Typ
Rejection	0.289 - 2 GHz	30 dB	Min
	N/A	40 dB	Min
Dimension	Thickness	40 Mils	Max
RF Power	Power	4 Watts	Max

[Click here to return to main table.](#)



CLICK HERE TO DOWNLOAD DATA FILES

*Data files contain DXF and S2P files

DIMENSIONS – CASE SIZE A

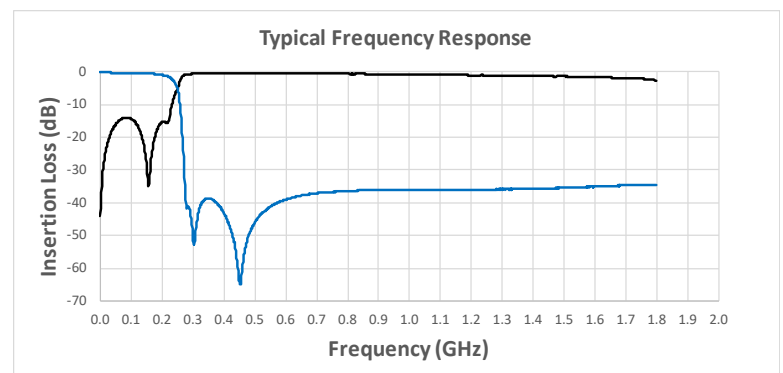
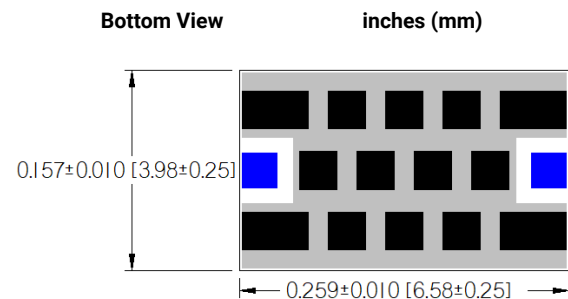

Multilayer Organic (MLO®) Filters

MLO® Low Pass Filters

LP0AA0204A7**

ELECTRICAL SPECIFICATIONS

Pass Band	DC - 0.204 GHz	1.2 dB	Max
	DC - 0.204 GHz	0.8 dB	Typ
	-3dB Cutoff	0.245 GHz	Typ
Rejection	0.293 - 2 GHz	30 dB	Min
	N/A	40 dB	Min
Dimension	Thickness	40 Mils	Max
RF Power	Power	4 Watts	Max

[Click here to return to main table.](#)



**CLICK HERE TO DOWNLOAD
DATA FILES**

*Data files contain DXF and S2P files

DIMENSIONS – CASE SIZE A

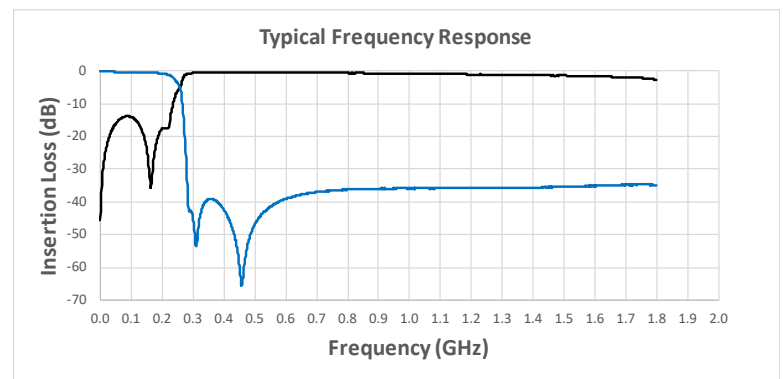
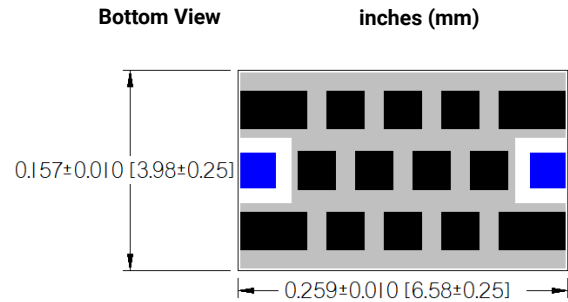

LP0AA0209A7**

ELECTRICAL SPECIFICATIONS

Pass Band	DC - 0.209 GHz	1.2 dB	Max
	DC - 0.209 GHz	0.8 dB	Typ
	-3dB Cutoff	0.252 GHz	Typ
Rejection	0.303 - 2 GHz	30 dB	Min
	N/A	40 dB	Min
Dimension	Thickness	40 Mils	Max
RF Power	Power	4 Watts	Max

[Click here to return to main table.](#)



**CLICK HERE TO DOWNLOAD
DATA FILES**

*Data files contain DXF and S2P files

DIMENSIONS – CASE SIZE A

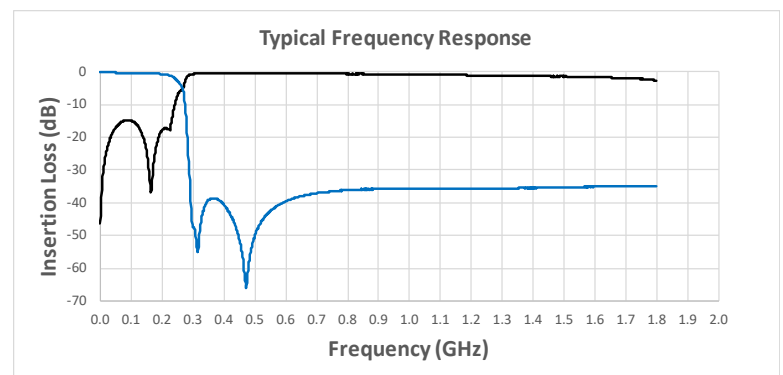
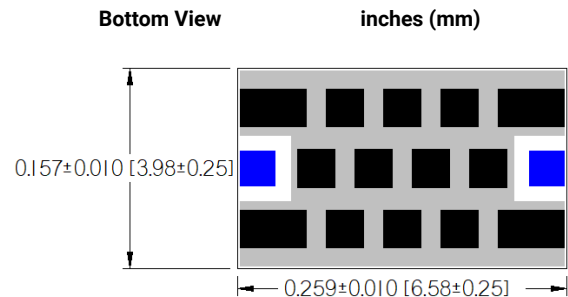

Multilayer Organic (MLO®) Filters

MLO® Low Pass Filters

LP0AA0279A7**

ELECTRICAL SPECIFICATIONS

Pass Band	DC - 0.279 GHz	1.2 dB	Max
	DC - 0.279 GHz	0.8 dB	Typ
	-3dB Cutoff	0.339 GHz	Typ
Rejection	0.398 - 2 GHz	30 dB	Min
	N/A	40 dB	Min
Dimension	Thickness	40 Mils	Max
RF Power	Power	4 Watts	Max

[Click here to return to main table.](#)



**CLICK HERE TO DOWNLOAD
DATA FILES**

*Data files contain DXF and S2P files

DIMENSIONS – CASE SIZE A

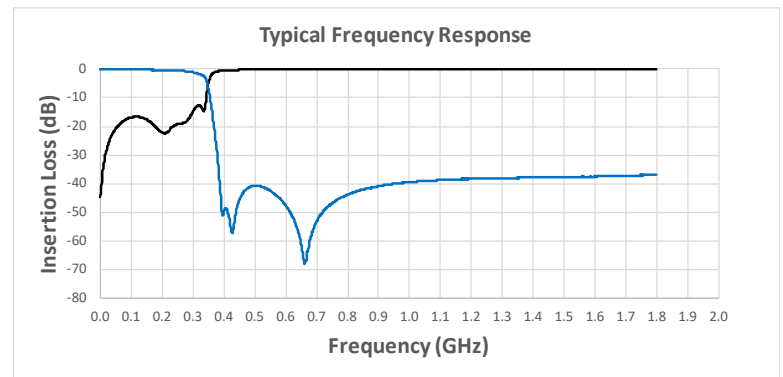
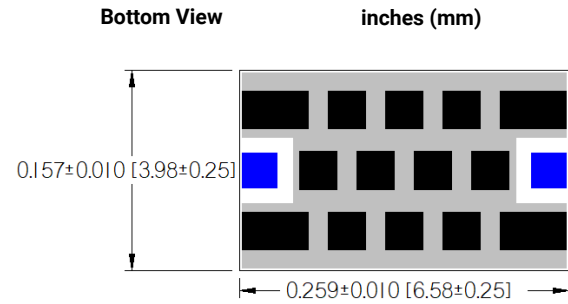

LP0AA0290A7**

ELECTRICAL SPECIFICATIONS

Pass Band	DC - 0.29 GHz	1.2 dB	Max
	DC - 0.29 GHz	0.8 dB	Typ
	-3dB Cutoff	0.351 GHz	Typ
Rejection	0.415 - 2 GHz	30 dB	Min
	N/A	40 dB	Min
Dimension	Thickness	40 Mils	Max
RF Power	Power	4 Watts	Max

[Click here to return to main table.](#)



**CLICK HERE TO DOWNLOAD
DATA FILES**

*Data files contain DXF and S2P files

DIMENSIONS – CASE SIZE A

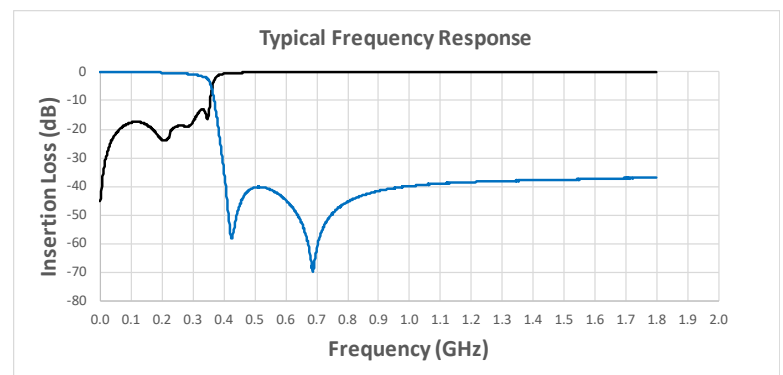
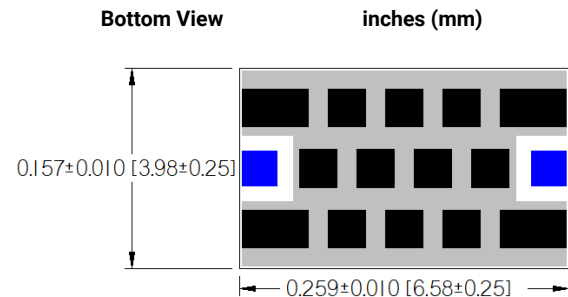

Multilayer Organic (MLO®) Filters

MLO® Low Pass Filters

LP0AA0299A7**

ELECTRICAL SPECIFICATIONS

Pass Band	DC - 0.299 GHz	1.2 dB	Max
	DC - 0.299 GHz	0.8 dB	Typ
	-3dB Cutoff	0.363 GHz	Typ
Rejection	0.427 - 2 GHz	30 dB	Min
	N/A	40 dB	Min
Dimension	Thickness	40 Mils	Max
RF Power	Power	4 Watts	Max

[Click here to return to main table.](#)



**CLICK HERE TO DOWNLOAD
DATA FILES**

*Data files contain DXF and S2P files

DIMENSIONS – CASE SIZE A

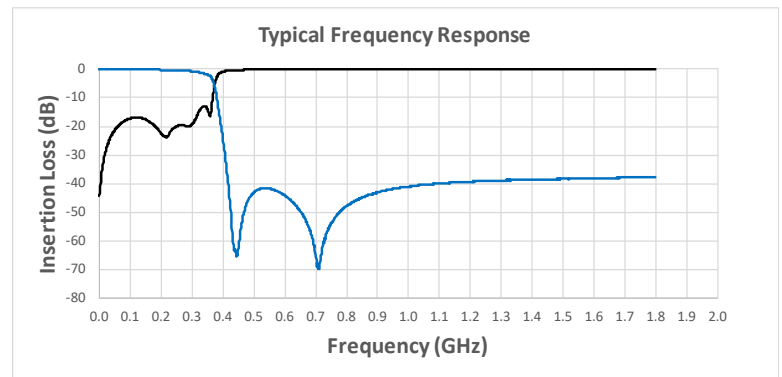
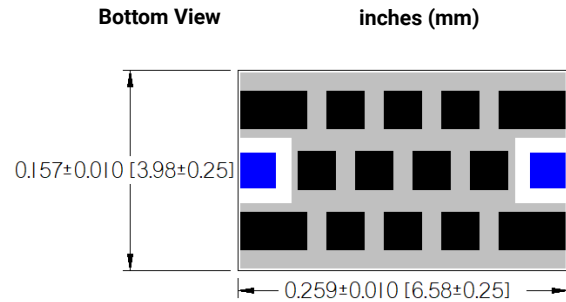

LP0AA0316A7**

ELECTRICAL SPECIFICATIONS

Pass Band	DC - 0.316 GHz	1.2 dB	Max
	DC - 0.316 GHz	0.8 dB	Typ
	-3dB Cutoff	0.378 GHz	Typ
Rejection	0.446 - 2 GHz	30 dB	Min
	N/A	40 dB	Min
Dimension	Thickness	40 Mils	Max
RF Power	Power	4 Watts	Max

[Click here to return to main table.](#)



**CLICK HERE TO DOWNLOAD
DATA FILES**

*Data files contain DXF and S2P files

DIMENSIONS – CASE SIZE A

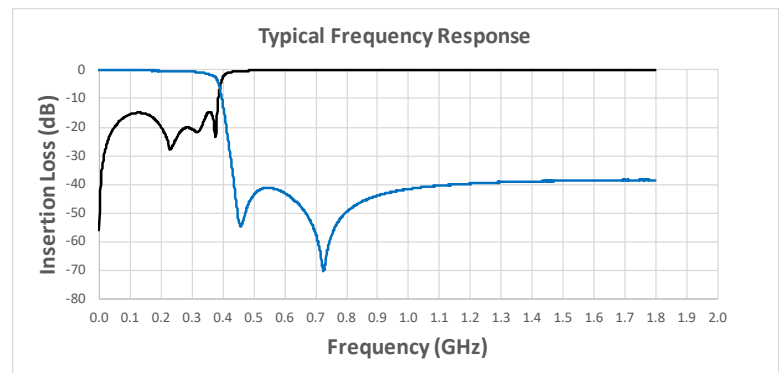
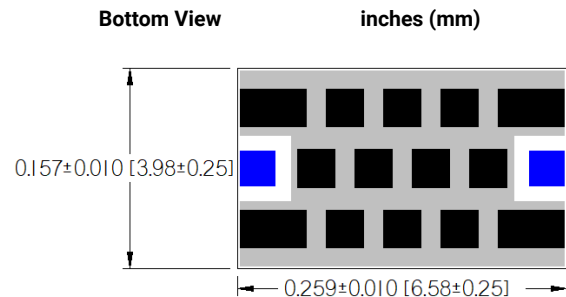

Multilayer Organic (MLO®) Filters

MLO® Low Pass Filters

LP0AA0322A7**

ELECTRICAL SPECIFICATIONS

Pass Band	DC - 0.322 GHz	1.2 dB	Max
	DC - 0.322 GHz	0.8 dB	Typ
	-3dB Cutoff	0.386 GHz	Typ
Rejection	0.454 - 2 GHz	30 dB	Min
	N/A	40 dB	Min
Dimension	Thickness	40 Mils	Max
RF Power	Power	4 Watts	Max

[Click here to return to main table.](#)



**CLICK HERE TO DOWNLOAD
DATA FILES**

*Data files contain DXF and S2P files

DIMENSIONS – CASE SIZE A

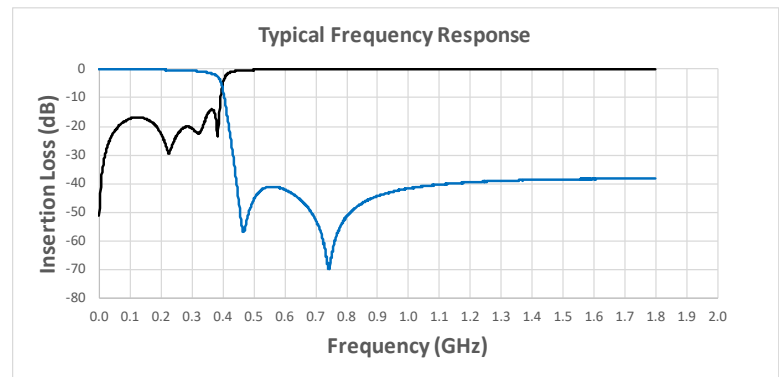
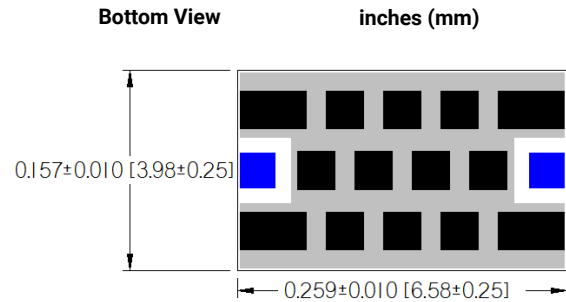

LP0AA0327A7**

ELECTRICAL SPECIFICATIONS

Pass Band	DC - 0.327 GHz	1.2 dB	Max
	DC - 0.327 GHz	0.8 dB	Typ
	-3dB Cutoff	0.392 GHz	Typ
Rejection	0.462 - 2 GHz	30 dB	Min
	N/A	40 dB	Min
Dimension	Thickness	40 Mils	Max
RF Power	Power	4 Watts	Max

[Click here to return to main table.](#)



**CLICK HERE TO DOWNLOAD
DATA FILES**

*Data files contain DXF and S2P files

DIMENSIONS – CASE SIZE A

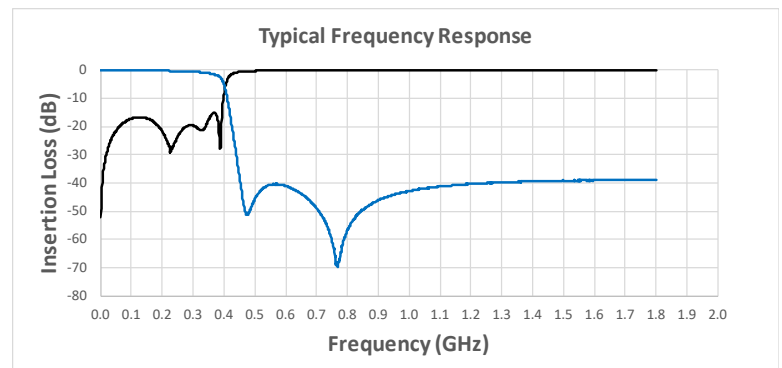
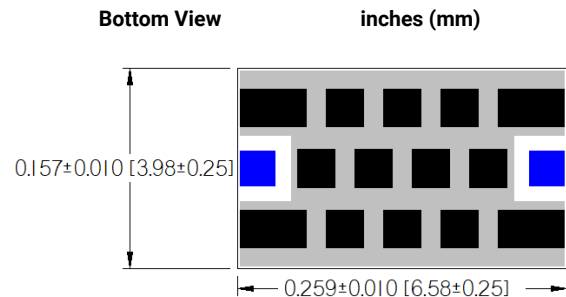

X-ON Electronics

Largest Supplier of Electrical and Electronic Components

Click to view similar products for [Signal Conditioning category](#):

Click to view products by [Kyocera AVX manufacturer](#):

Other Similar products are found below :

[MAPDCC0001](#) [MAPDCC0004](#) [PD0409J5050S2HF](#) [880157](#) [HHS-109-PIN](#) [DC1417J5005AHF](#) [AFS14A30-2185.00-T3](#) [AFS14A35-1591.50-T3](#) [DS-323-PIN](#) [B39321R801H210](#) [1A0220-3](#) [JP510S](#) [LFB212G45SG8C341](#) [LFB322G45SN1A504](#) [LFL182G45TC3B746](#) [SF2159E](#) [30057](#) [FM-104-PIN](#) [CER0813B](#) [MAPDCC0005](#) [3A325](#) [40287](#) [41180](#) [ATB3225-75032NCT](#) [BD0810N50100AHF](#) [BD2425J50200AHF](#) [C5060J5003AHF](#) [JHS-115-PIN](#) [JP503AS](#) [DC0710J5005AHF](#) [DC2327J5005AHF](#) [DC3338J5005AHF](#) [43020](#) [LFB2H2G60BB1C106](#) [LFL15869MTC1B787](#) [X3C19F1-20S](#) [XC3500P-20S](#) [10013-20](#) [SF2194E](#) [CDBLB455KCAX39-B0](#) [TGL2208-SM, EVAL](#) [RF1353C](#) [1E1305-3](#) [1F1304-3S](#) [1G1304-30](#) [B0922J7575AHF](#) [2020-6622-20](#) [10017-3](#) [TP-103-PIN](#) [BD1222J50200AHF](#)