

Prestta™ Standard Penta-Band Cellular Embedded Antenna

850/900/1800/1900/2100 MHz



Ethertronics' Prestta series of Isolated Magnetic Dipole™ (IMD) embedded antennas address the challenges facing today's product designers. IMD's high performance and isolation characteristics offer better connectivity and minimal interference. Prestta antennas can be used in a variety of applications including:

- M2M
- Automotive
- Automatic Meter Reading
- Healthcare
- Point of Sale
- Tracking

TECHNOLOGY ADVANTAGES

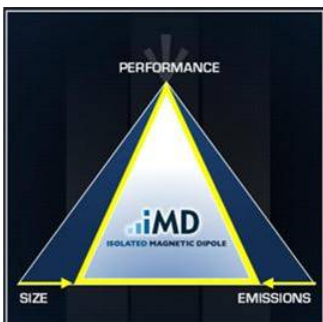

Stays in Tune
IMD antenna technology provides superior RF field containment, resulting in less interaction with surrounding components. Ethertronics IMD antennas resist de-tuning; providing a robust radio link regardless of the usage position.

Prestta antennas use patented IMD technology in a stamped metal configuration to provide high performance. IMD antennas requires a smaller design keep-out area, carry lower program development risk which yields a quicker time-to-market, without sacrificing RF performance.



KEY BENEFITS

DESIGN ADVANTAGES

Reduced Costs and Time-to-Market

- Standard antenna eliminates design fees and cycle time associated with a custom solution; getting products to market faster.

Greater Flexibility with Unique Form Factors

- Ethertronics' IMD technology helps you deliver more advanced ergonomic designs without adverse impact on product performance.
- SMD mountable design enables faster and lower cost manufacturing.

RoHS Compliant

- Ethertronics' antennas are fully compliant with the European RoHS Directive 2002/95/EC.

END USER ADVANTAGES

Unique Form Factors Support Advanced Industrial Designs

- Smaller, more efficient IMD embedded antennas break through restrictive design rules and provide new freedom in component placement.

Superior Range

- Better antenna function means longer range and greater sensitivity to critically precise signals—delivering greater customer satisfaction while building brand loyalty.

SERVICE AND SUPPORT

Extensive RF Experience

- Our Prestta antennas are supported by documentation, and when needed, by the expertise of RF engineers who have integrated hundreds of antenna designs into wireless devices.

Global Operations & Design Support

- Ethertronics' global operations supports an integrated network of design centers that can take projects from concept to production.

PRODUCT: Cellular

Example: Ethertronics' Penta-Band Internal (Embedded) Antenna Specifications.

Below are the typical specs for a Penta-Band application (subject to change).

Electrical Specifications

Typical Characteristics

Measurements taken with no ground plane or a 65 x 110 mm ground plane.

Antenna mounted directly on PC + ABS housing material.

Cellular Antenna (MHz)	824-849, 869-894	880-915, 925-960	1710-1785, 1805-1880	1850-1910, 1930-1990	1920- 1980, 2110-2170
Peak Gain (no ground)	-0.2dBi	-0.6dBi	3.4dBi	3.2dBi	1.9dBi
Peak Gain (horizontal ground)	2.5dBi	1.7dBi	1.7dBi	3.2dBi	3.8dBi
Peak Gain (vertical ground)	3.0dBi	2.4dBi	2.3dBi	2.7dBi	3.4dBi
Average Efficiency (no ground)	45%	40%	60%	45%	45%
Average Efficiency (horizontal ground)	73%	62%	63%	66%	62%
Average Efficiency (vertical ground)	78%	67%	60%	60%	60%
VSWR Match	3.0:1 max				
Feed Point Impedance	50 ohms unbalanced (other if required)				
Radiation Pattern	Omni-directional				
Power Handling	2 Watt cw				
Polarization	Linear				

Mechanical Specifications

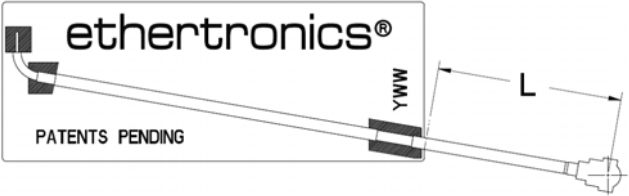
Maximum Dimensions	41.0 0x 15.00x.12 mm (1.25m high at cable solder connection)
Cable / Connector	Contact Ethertronics for details
Cable Length	<p>P522306—Antenna with 200mm cable, EP, U.FL receptacle compatible P522307—Antenna with 100mm cable, MMCX Plug, Male Right Angle connector P522308—Antenna with 200mm cable, MMCX Plug, Male Right Angle connector P522309—Antenna with 100mm cable, EP, U.FL receptacle compatible P522310—Antenna with 18mm cable, EP, U.FL receptacle compatible</p> 

PRODUCT: Cellular

Test Set-up

Antenna mounted directly on PC + ABS housing material.

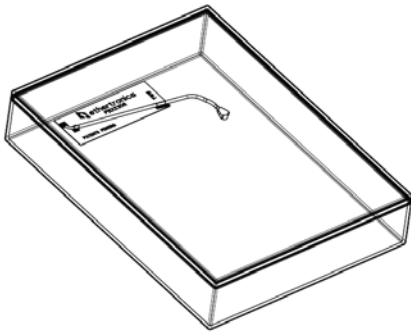
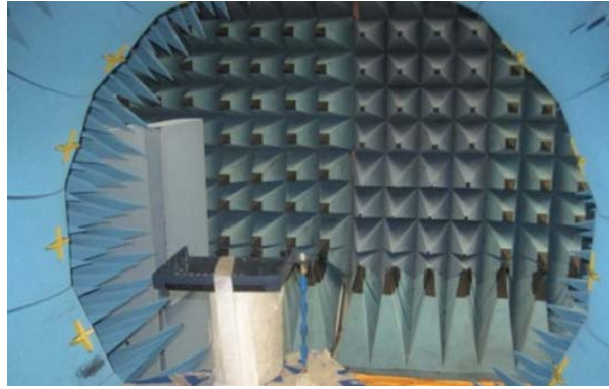

— No Ground

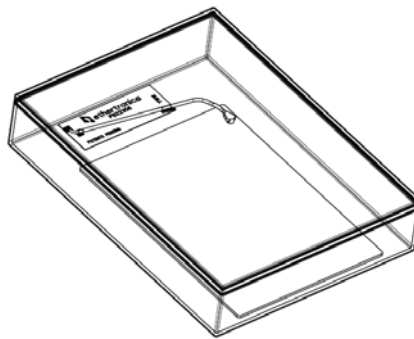

— Horizontal Ground

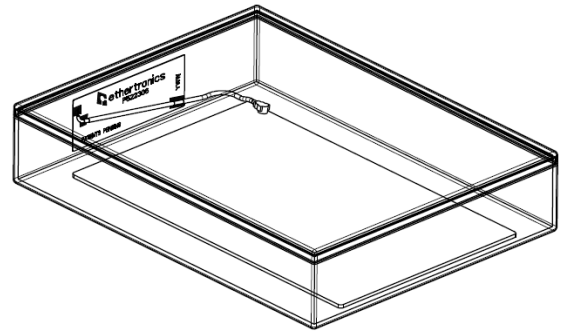

— Vertical Ground

Typical Efficiency

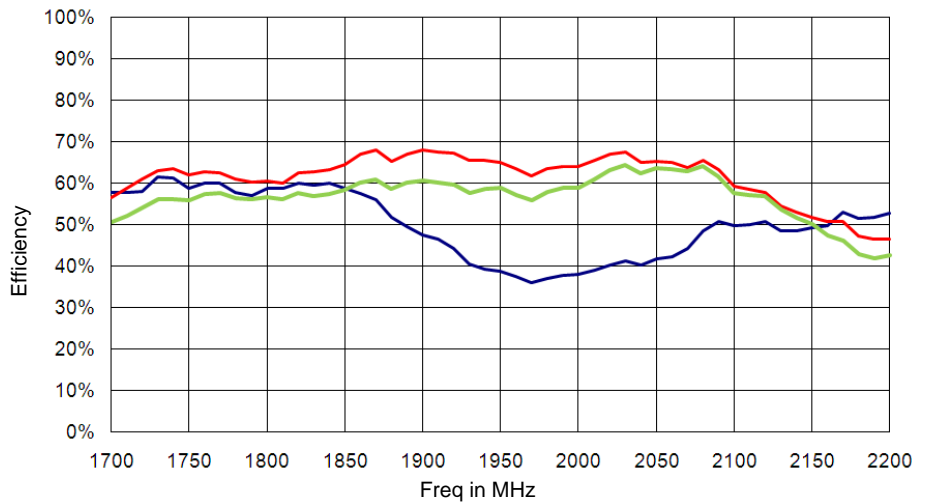
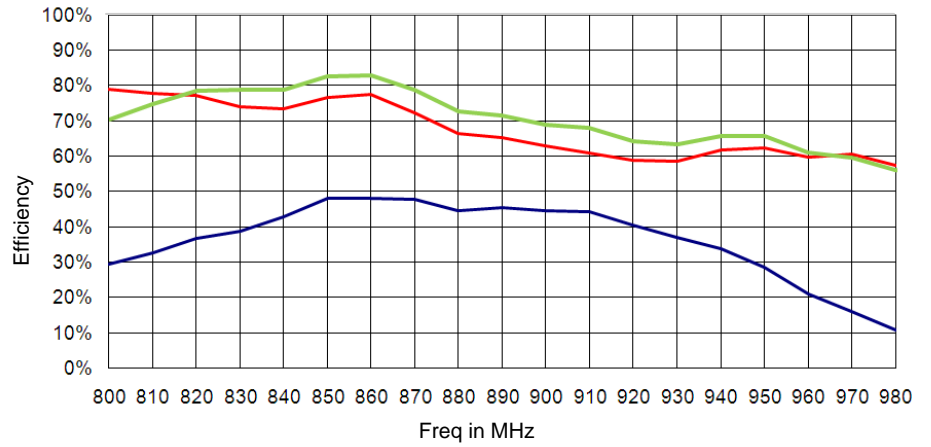

Typical Return Loss

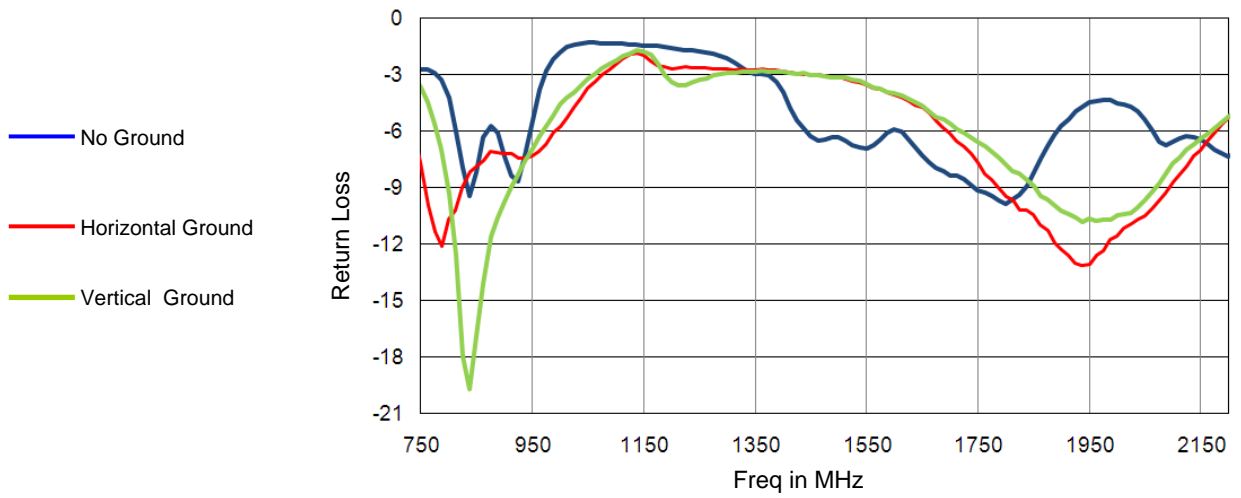

VSWR

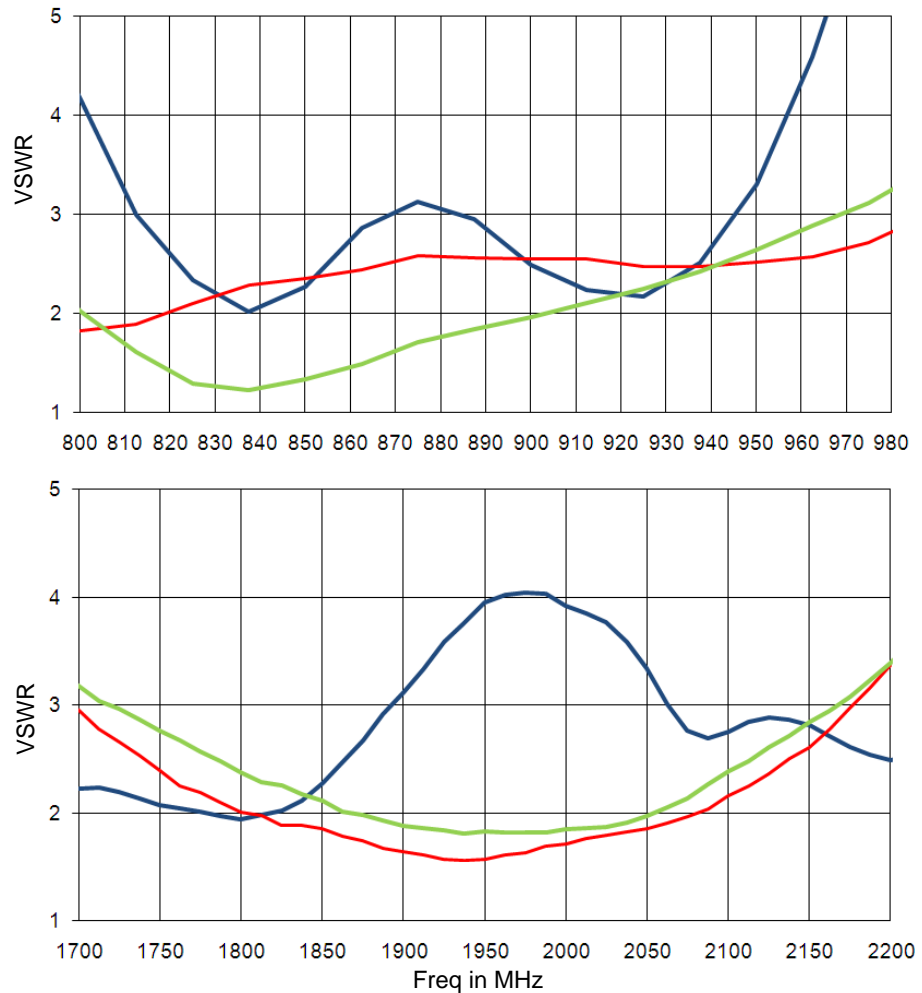

PRODUCT: Cellular
Antenna Radiation Patterns

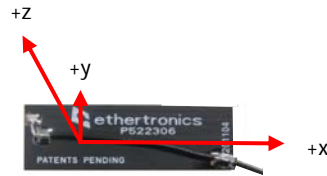

No Ground

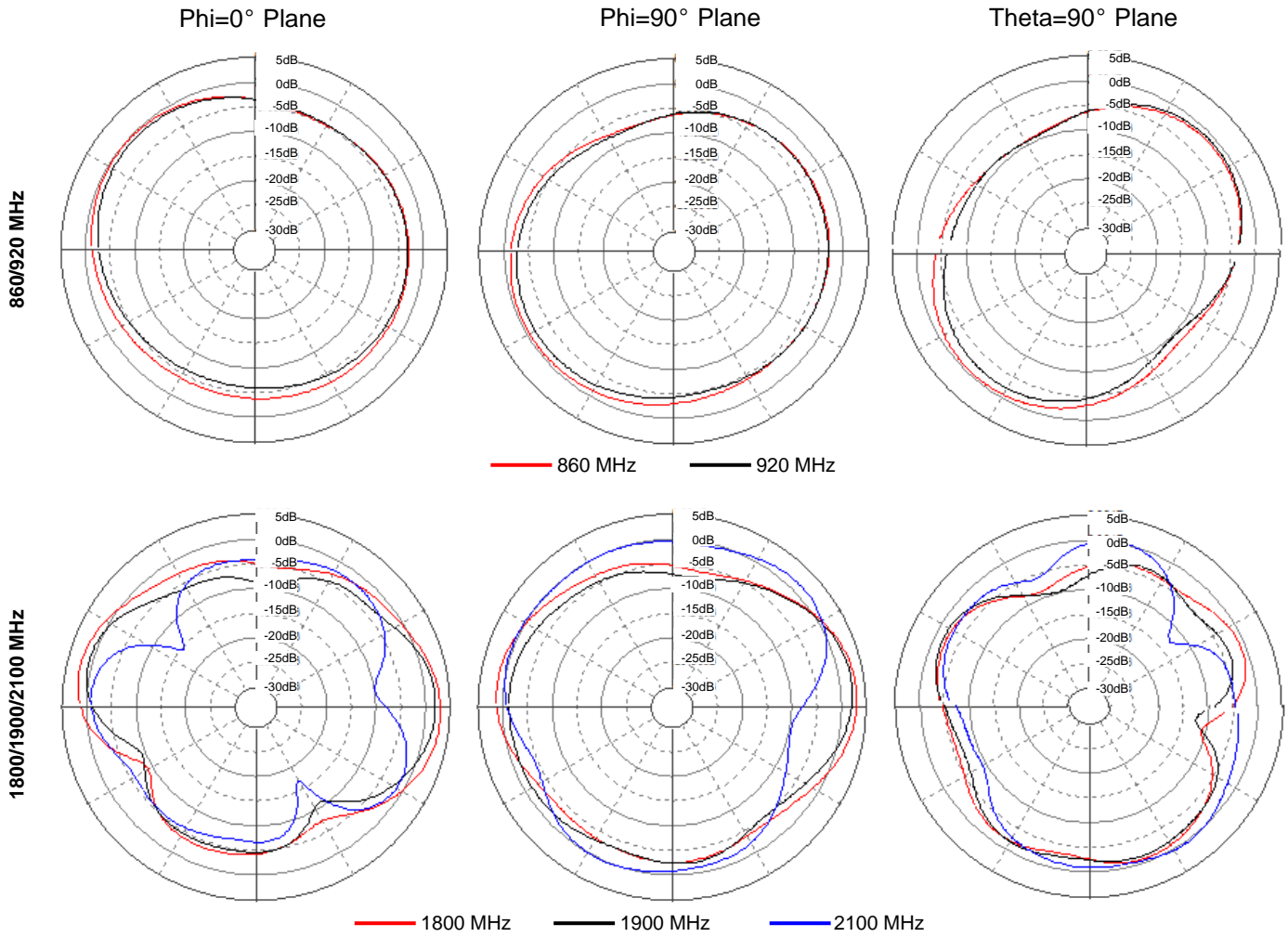

PRODUCT: Cellular
Antenna Radiation Patterns

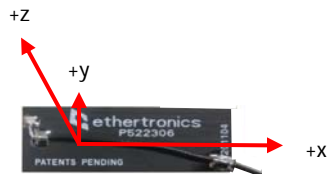

Horizontal Ground

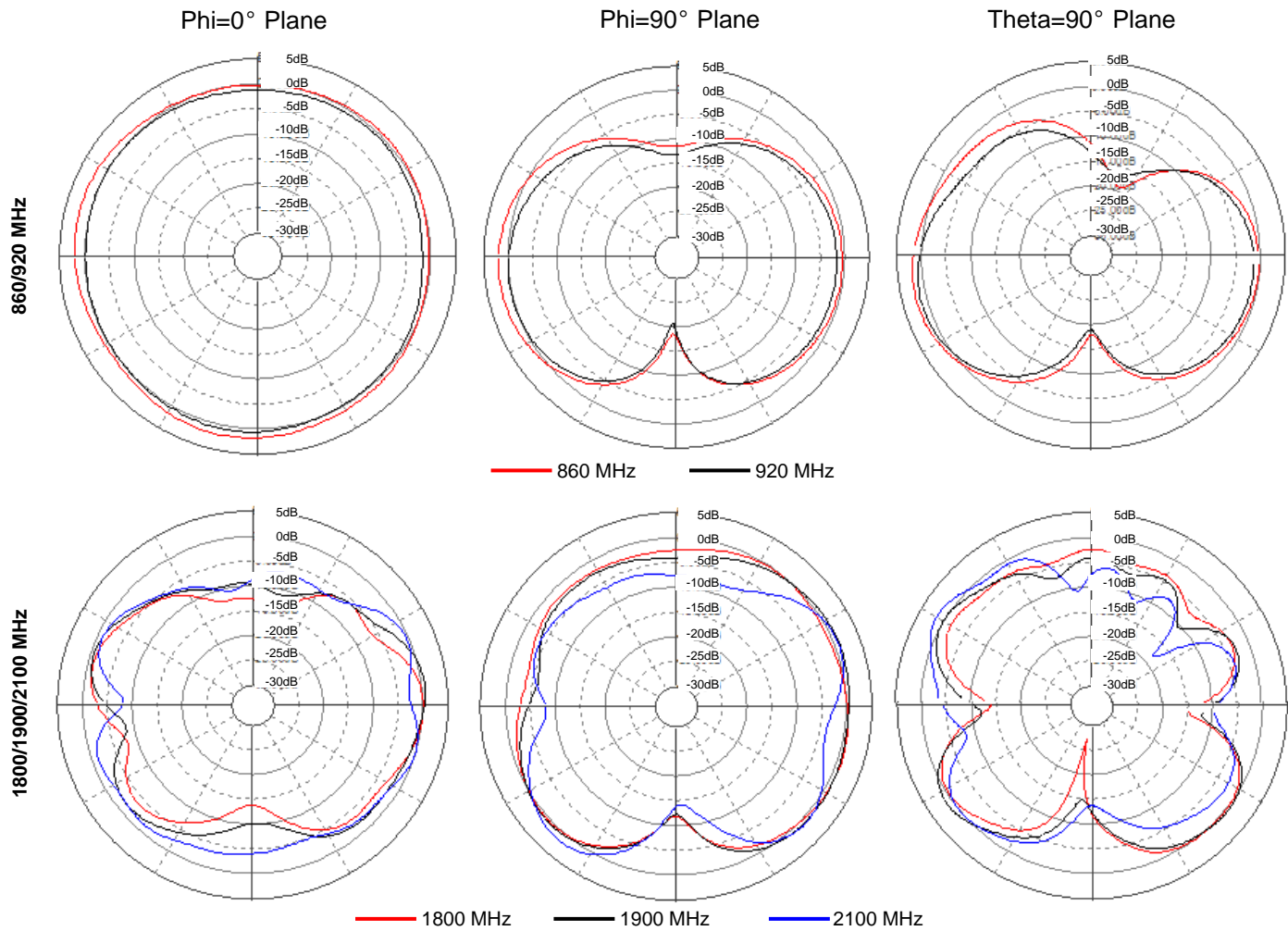

PRODUCT: Cellular
Antenna Radiation Patterns

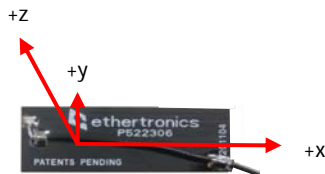

Vertical Ground

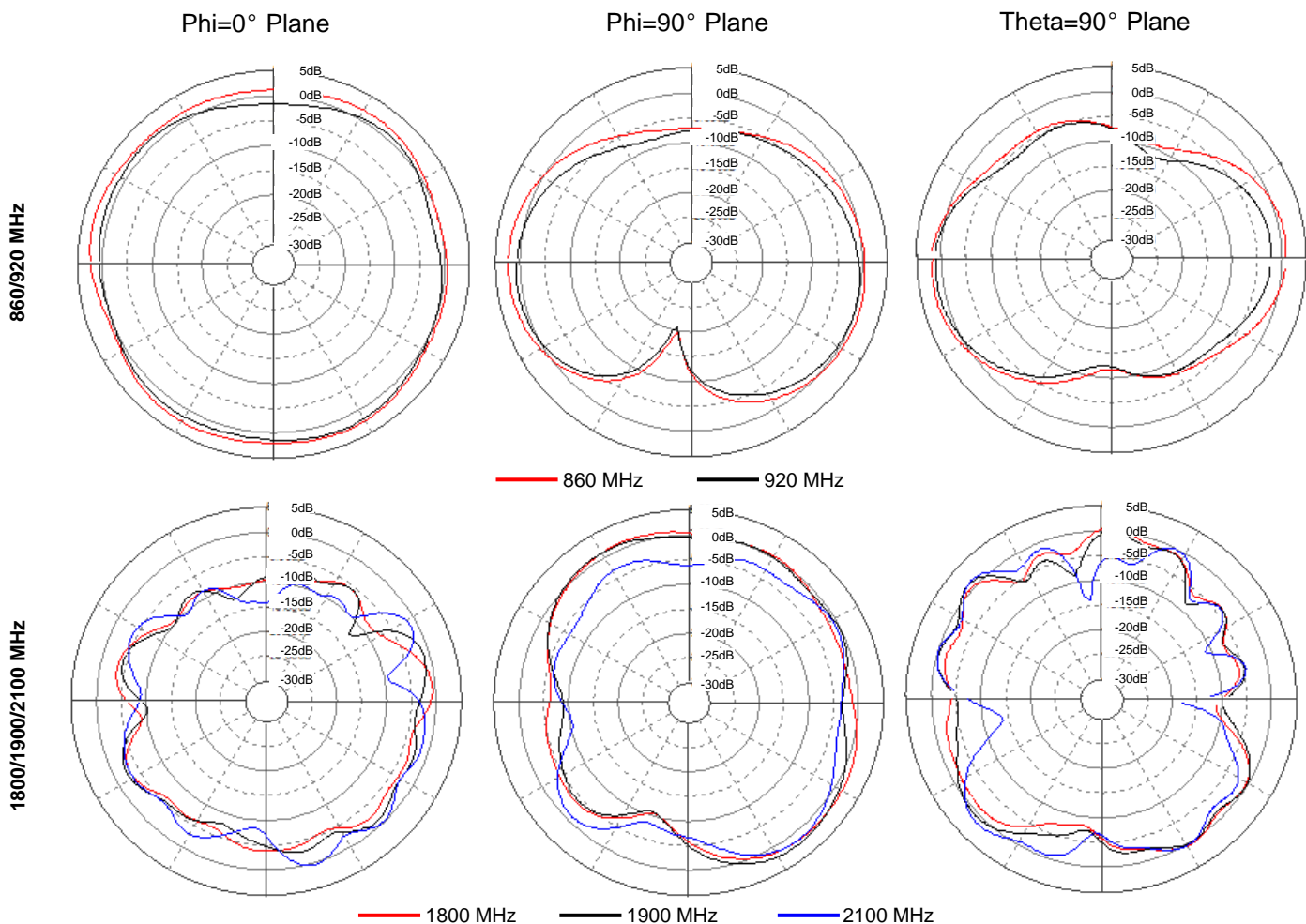

X-ON Electronics

Largest Supplier of Electrical and Electronic Components

Click to view similar products for [Antennas](#) category:

Click to view products by [Kyocera AVX](#) manufacturer:

Other Similar products are found below :

[GAN30084EU](#) [930-033-R](#) [GW17.07.0250E](#) [1513563-1](#) [EXE902SM](#) [APAMPG-117](#) [MAF94383](#) [W3908B0100](#) [W6102B0100](#) [YE572113-30RSMM](#) [108-00014-50](#) [66089-2406](#) [SPDA17RP918](#) [A09-F8NF-M](#) [A09-F5NF-M](#) [RGFRA1903041A1T](#) [W3593B0100](#) [W3921B0100](#) [SIMNA-868](#) [SIMNA-915](#) [SIMNA-433](#) [W1044](#) [W1049B090](#) [A75-001](#) [WTL2449CQ1-FRSMM](#) [CPL9C](#) [EXB148BN](#) [0600-00060](#) [TRA9020S3PBN-001](#) [Y4503](#) [GD5W-28P-NF](#) [MA9-7N](#) [GD53-25](#) [GD5W-21P-NF](#) [C37](#) [MAF94051](#) [MA9-5N](#) [EXD420PL](#) [B1322NR](#) [QWFTB120](#) [MAF94271](#) [MAF94300](#) [GPSMB301](#) [FG4403](#) [AO-AGSM-OM54](#) [5200232](#) [MIKROE-2349](#) [WCM.01.0111](#) [MIKROE-2393](#) [MIKROE-2352](#)