

Part No. P822603 / P822604

FR4 Embedded LTE / LPWA Antenna – Corner/side ground

698 – 960 MHz / 1710 - 2700 MHz

Supports: Broadband LTE (OCTA-BAND), LTE CAT-M, NB-IoT, SigFox, LoRa, Cellular LPWA, RPMA

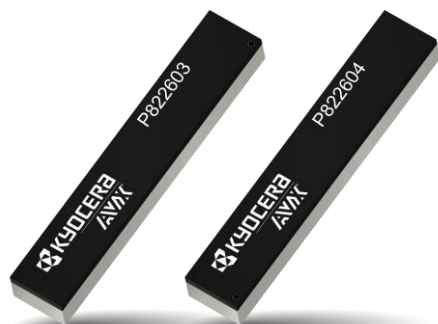

*Mirrored version offered as P822604

KYOCERA AVX's Universal Broadband Embedded LTE/LPWA antenna utilizes Isolated Magnetic Dipole™ (IMD) technology which address the challenges facing today's product designers. IMD's high performance and isolation characteristics offer better connectivity and minimal interference. Main advantage: it is compatible for corner placement. Mirrored version variant offered as P822604.

Stays in Tune

KYOCERA AVX antennas use patented IMD technology in many antenna configurations to provide high performance. IMD antennas requires a smaller design keep-out area, carry lower program development risk which yields a quicker time-to-market, without sacrificing RF performance.

Electrical Specifications

Typical P822603/P822604 performance 140 x 65 mm PCB

Frequency (MHz)	698-960	1710-2170	2500-2700
Peak Gain	0.7 dBi	1.0 dBi	0.4 dBi
Average Efficiency	59%	59%	39%
VSWR	<3.4:1	<2.5:1	<3.3:1
Polarization	Linear		
Power Handling	2 Watt CW		
Feed Point Impedance	50 Ω unbalanced		

Universal Broadband FR4 Embedded LTE Antenna

Low Band 700 – 1000 MHz
High Band 1700 - 2700 MHz

KEY BENEFITS

Reduced Costs and Time-to-Market

Standard antenna eliminates design fees and cycle time associated with a custom solution; getting products to market faster.

Greater Flexibility with Unique Form Factors

KYOCERA AVX's technology helps you deliver more advanced ergonomic designs without adverse impact on product performance.

Environmental Compliance

Products are the latest RoHS version compliant.

APPLICATIONS

- Medical applications
- Home automation
- Smart metering
- M2M, Industrial devices
- IoT
- Firstnet
- Healthcare
- Point of Sale
- Tracking

Mechanical Specifications & Ordering Part Number

Ordering Part #	P822603	P822604
Dimensions (mm)	49.6 x 8.0 x 3.2	49.6 x 8.0 x 3.2
Mounting Type	SMT (P&P)	
Variant	P822604 : Mirrored version of P822603	
Weight (grams)	2.6	
Packaging	Tape and Reel	
Storage Temperature/ Humidity (Sealed shipping package)	+5°C to +35°C 45~75%	
Operating Temperature	-40 to +85 C	
Demo Board	P822603-01 (P822603) P822604-01 (P822604)	

Universal Broadband Embedded LTE KYOCERA AVX Antenna Specifications.
 KYOCERA AVX produces a wide variety of standard and custom antennas to meet user needs.

LTE Bands covered by (P822603/P822604)

LTE Band	Frequency Band (MHz)	Uplink (UL) (MHz)	Downlink (DL) (MHz)	Region	Covered
1	2100	1920 - 1980	2110 - 2170	Global	Yes
2	1900	1850 - 1910	1930 - 1990	NAM	
3	1800	1710 - 1785	1805 - 1880	Global	
4	1700	1710 - 1755	2110 - 2155	NAM	
5	850	824 - 849	869 - 894	NAM	
6	850	830 - 840	875 - 885	APAC	
7	2600	2500 - 2570	2620 - 2690	EMEA	
8	900	880 - 915	925 - 960	Global	
9	1800	1749.9 - 1784.9	1844.9 - 1879.9	APAC	
10	1700	1710 - 1770	2110 - 2170	NAM	
11	1500	1427.9 - 1447.9	1475.9 - 1495.9	Japan	No
12	700	699 - 716	729 - 746	NAM	Yes
13	700	777 - 787	746 - 756	NAM	
14	700	788 - 798	758 - 768	NAM	
17	700	704 - 716	734 - 746	NAM	
18	850	815 - 830	860 - 875	Japan	
19	850	830 - 845	875 - 890	Japan	
20	800	832 - 862	791 - 821	EMEA	No
21	1500	1447.9 - 1462.9	1495.9 - 1510.9	Japan	
22	3500	3410 - 3490	3510 - 3590	EMEA	Yes
23	2000	2000 - 2020	2180 - 2200	NAM	No
24	1600	1626.5 - 1660.5	1525 - 1559	NAM	Yes
25	1900	1850 - 1915	1930 - 1995	NAM	
26	850	814 - 849	859 - 894	NAM	
27	850	807 - 824	852 - 869	NAM	
28	700	703 - 748	758 - 803	APAC,EU	
29	700	N/A	717 - 728	NAM	
30	2300	2305 - 23151	2350 - 2360	NAM	No
31	450	452.5 - 457.5	462.5 - 467.5	Global	
32	1500	N/A	1452 - 1496	EMEA	
33	1900		1900 - 1920		Yes
34	2000		2010 - 2025		
35	1850		1850 - 1910		
36	1900		1930 - 1990		
37	1900		1910 - 1930		
38	2600		2570 - 2620		
39	1900		1880 - 1920		
40	2300		2300 - 2400		
41	2500		2496 - 2690		
42	3500		3400 - 3600		
43	3700		3600 - 3800		

Universal Broadband Embedded LTE KYOCERA AVX Antenna Specifications.
KYOCERA AVX produces a wide variety of standard and custom antennas to meet user needs.

Antenna Dimensions (P822603)

Typical antenna dimensions (mm)

Part Number	A	B	C
P822603	49.6 ± 0.2	8.0 ± 0.2	3.2 ± 0.32

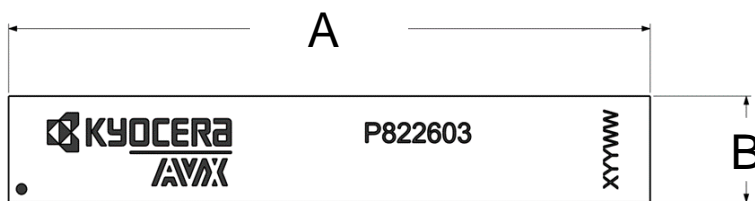
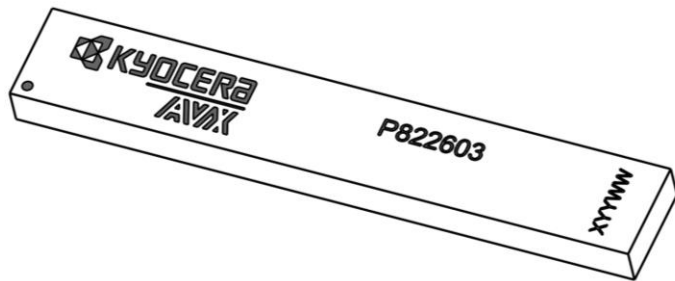

Top View

Pin#	Description
1	Feed
2	Ground
3	Dummy Pad
4	Dummy Pad
5	Dummy Pad
6	Dummy Pad

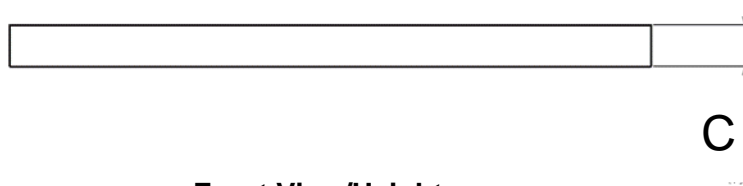

Front View/Height

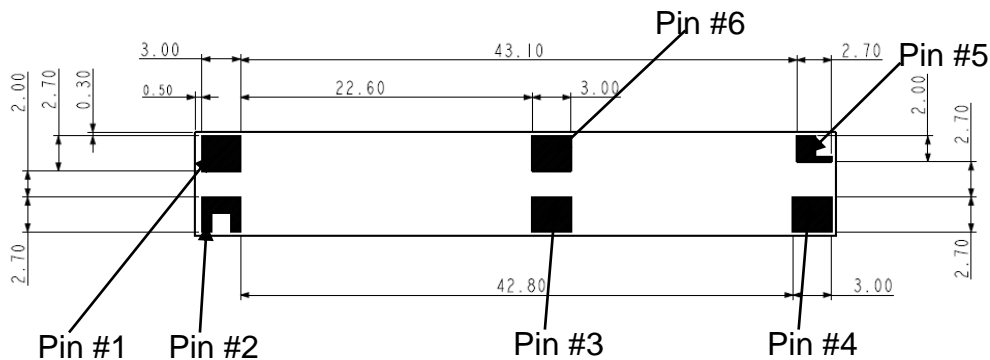

Bottom View

Universal Broadband Embedded LTE KYOCERA AVX Antenna Specifications.
KYOCERA AVX produces a wide variety of standard and custom antennas to meet user needs.

Antenna Dimensions (P822604)

Typical antenna dimensions (mm)

Part Number	A	B	C
P822604	49.6 ± 0.2	8.0 ± 0.2	3.2 ± 0.32

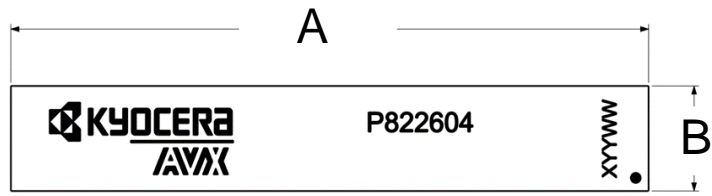

Top View

Pin#	Description
1	Feed
2	Ground
3	Dummy Pad
4	Dummy Pad
5	Dummy Pad
6	Dummy Pad

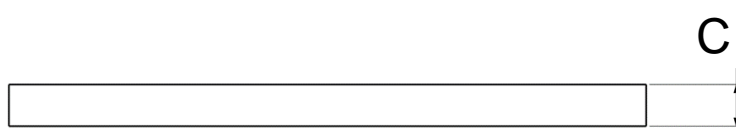

Front View/Height

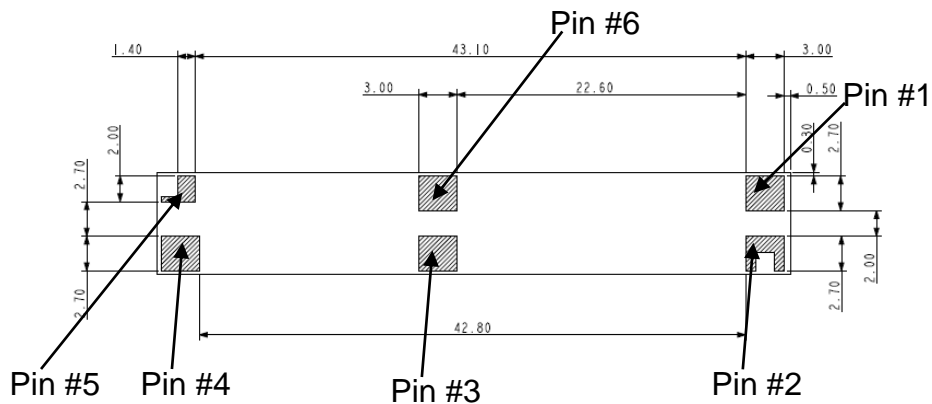

Bottom View

Universal Broadband Embedded LTE KYOCERA AVX Antenna Specifications.
 KYOCERA AVX produces a wide variety of standard and custom antennas to meet user needs.

VSWR, Efficiency, and Peak Gain Plots

Typical P822603/P822604 performance 140 x 65 mm PCB

Low Band VSWR

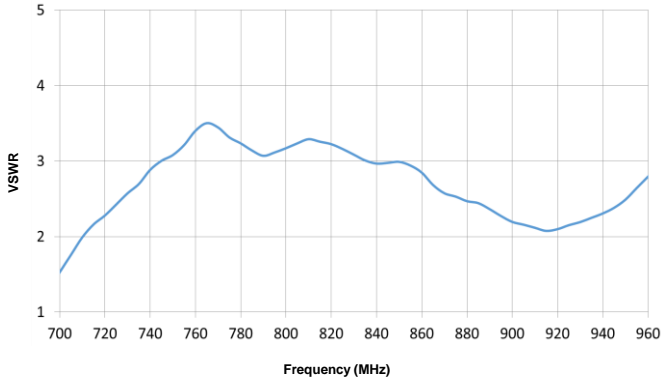

High Band VSWR

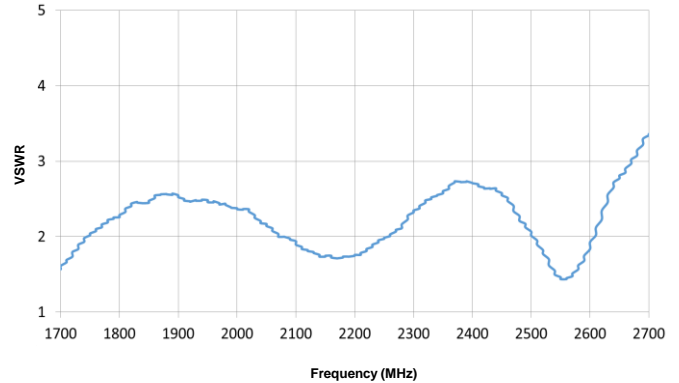

Low Band Efficiency

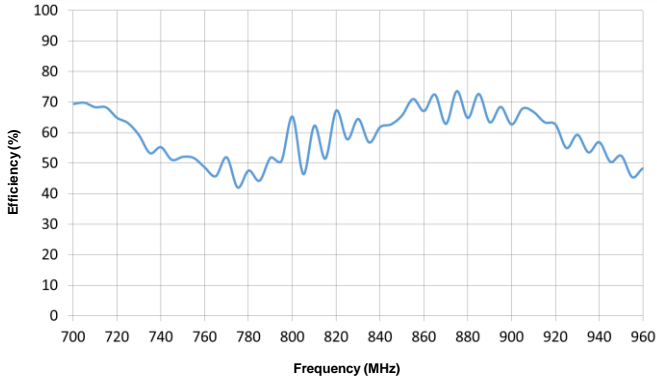

High Band Efficiency

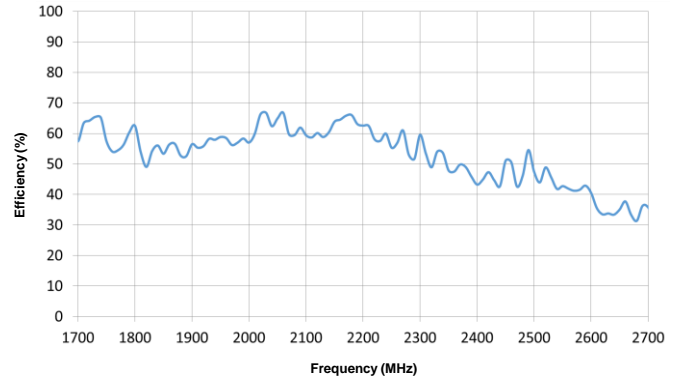

Low Band Peak Gain

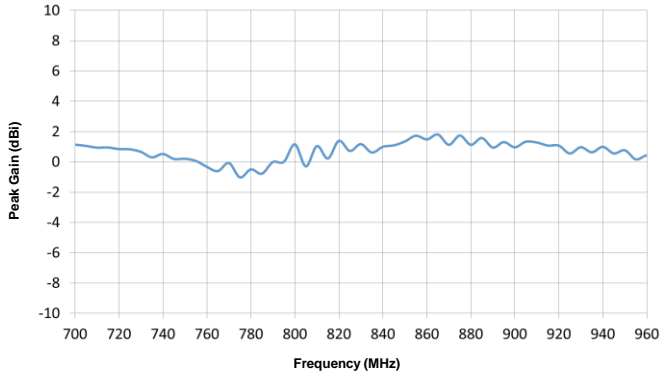

High Band Peak Gain

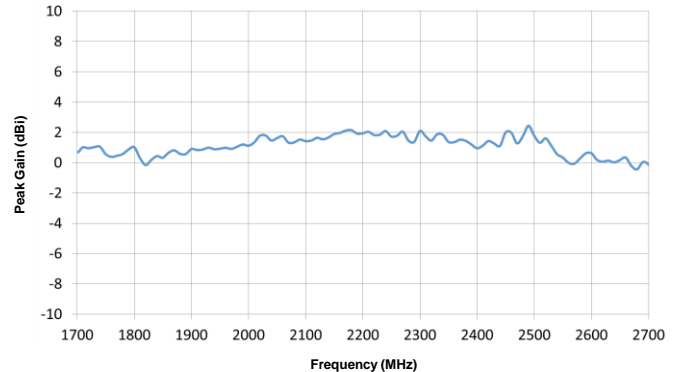

Universal Broadband Embedded LTE KYOCERA AVX Antenna Specifications.
KYOCERA AVX produces a wide variety of standard and custom antennas to meet user needs.

Antenna Radiation Patterns – Low Band & High Band

Typical P822603/P822604 performance 140 x 65 mm PCB

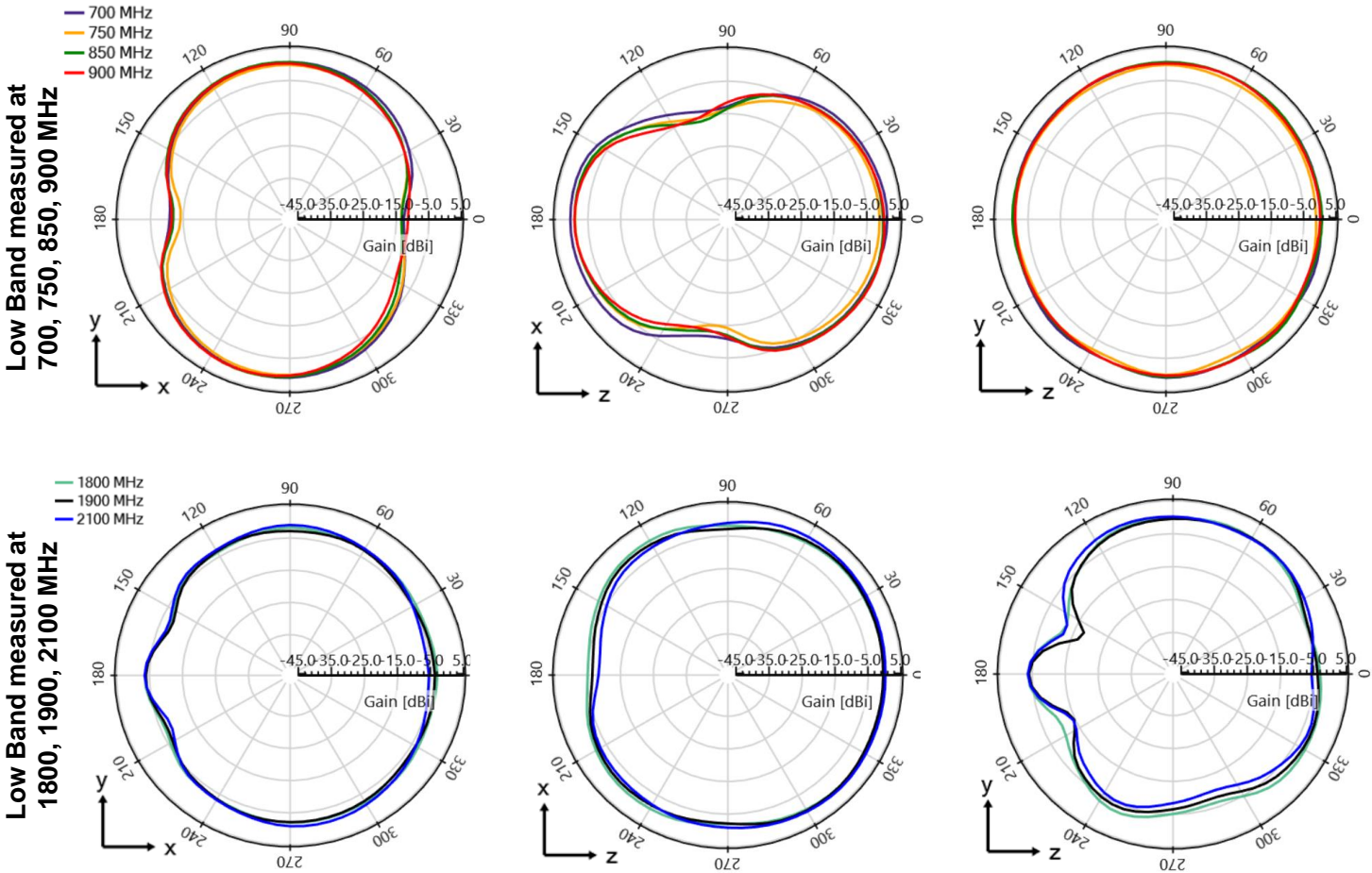
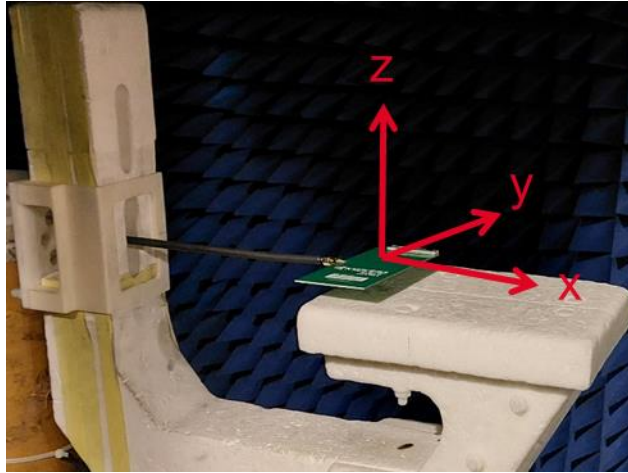

Universal Broadband Embedded LTE KYOCERA AVX Antenna Specifications.
KYOCERA AVX produces a wide variety of standard and custom antennas to meet user needs.

Antenna Radiation Patterns –High Band cont.

Typical P822603/P822604 performance 140 x 65 mm PCB

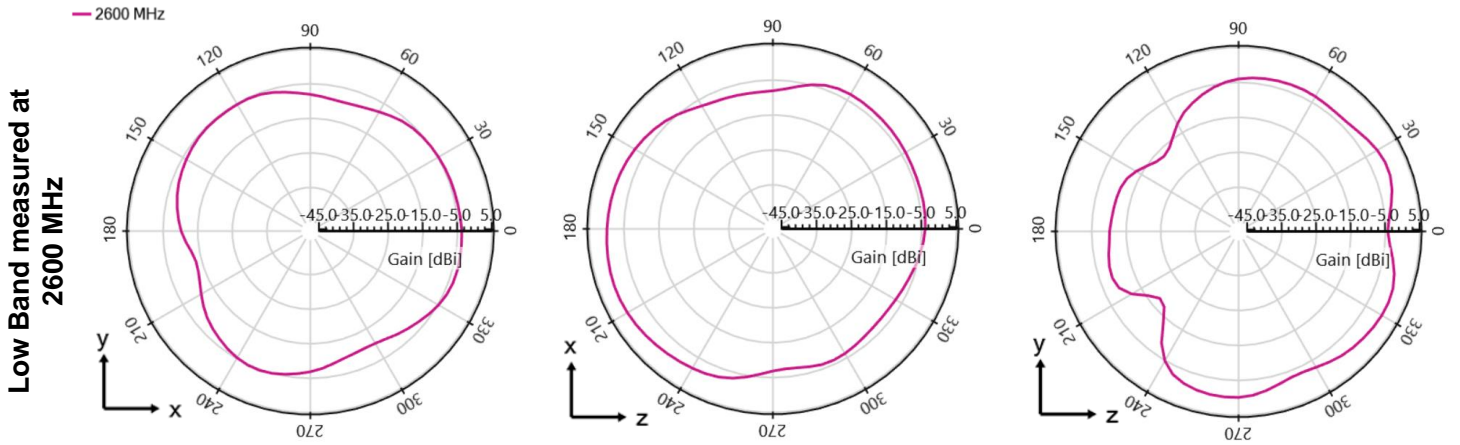
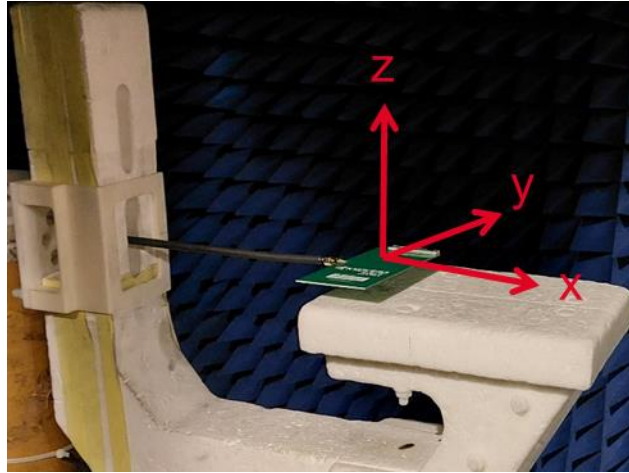

Universal Broadband Embedded LTE KYOCERA AVX Antenna Specifications.
 KYOCERA AVX produces a wide variety of standard and custom antennas to meet user needs.

Antenna layout (P822603-01)

Typical layout dimensions (mm)

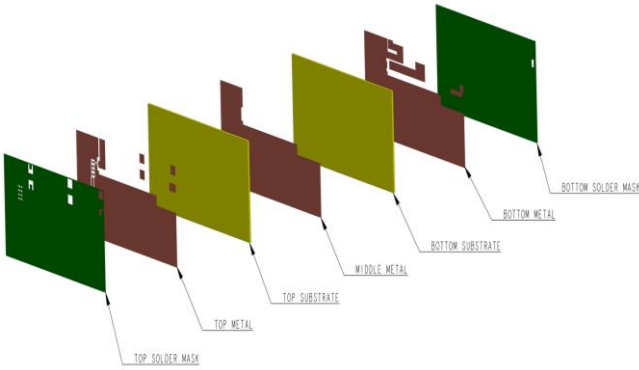

- Additional VIAS: Diam. 0.4mm to be placed around antenna, (no vias on transmission lines).
- Via holes must be covered by solder mask

Pin Descriptions

Pin#	Description
1	Feed
2	Feed
3	Dummy Pad
4	Dummy Pad
5	Dummy Pad
6	Dummy Pad

*P822604 uses the same layout but mirrored.

Default Pi Matching Network values with instructions can be found under Antenna Matching Network.

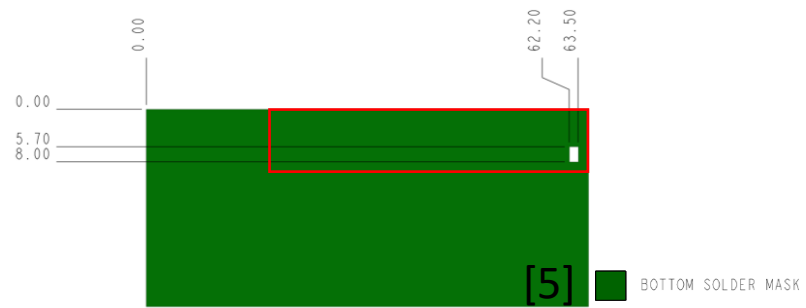
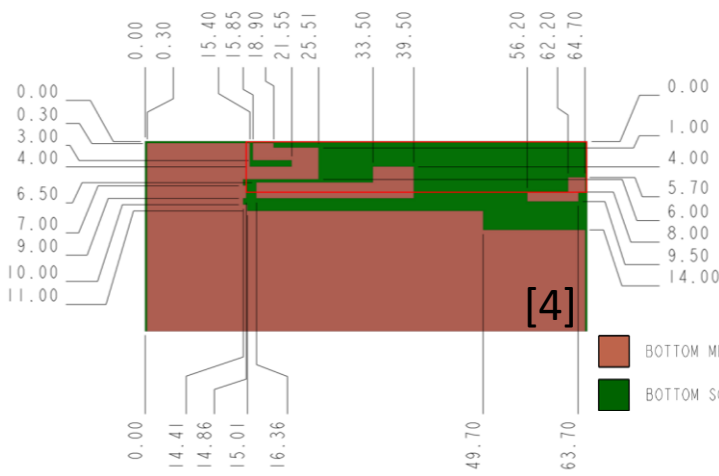
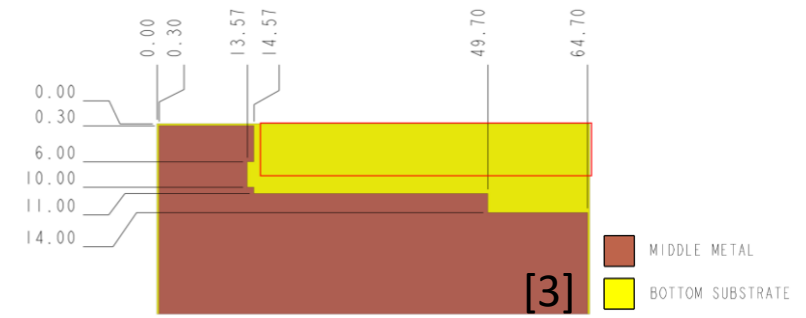
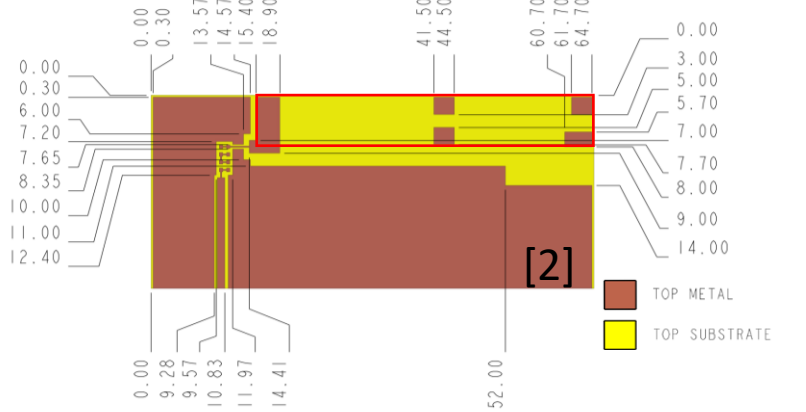
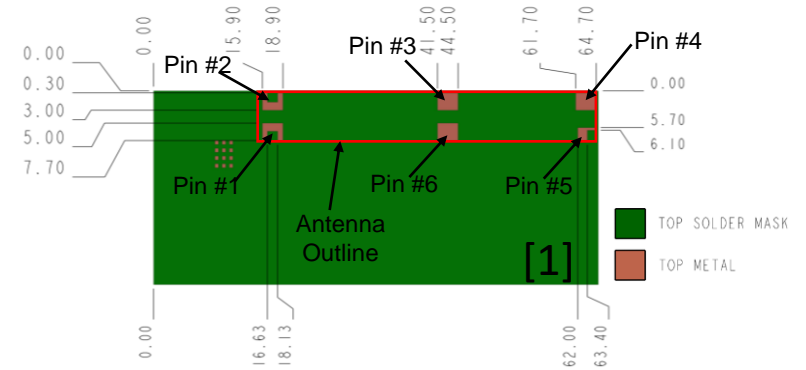

Universal Broadband Embedded LTE KYOCERA AVX Antenna Specifications.
KYOCERA AVX produces a wide variety of standard and custom antennas to meet user needs.

Antenna Matching Structure (P822603)

Typical matching values on 140 x 65 mm PCB

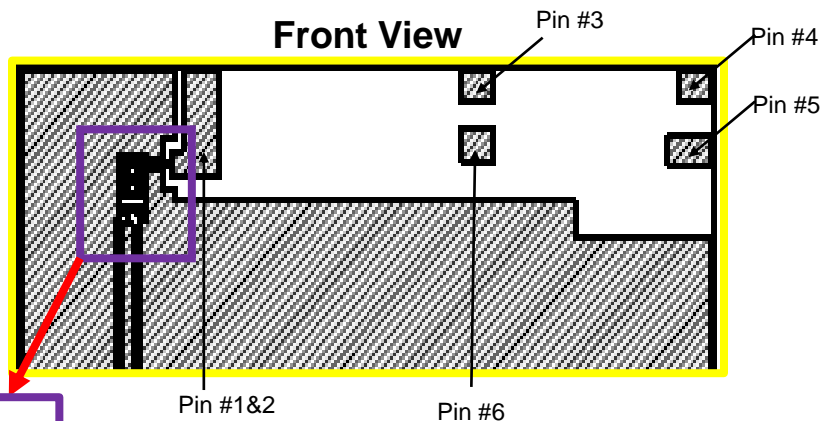

Antenna Matching

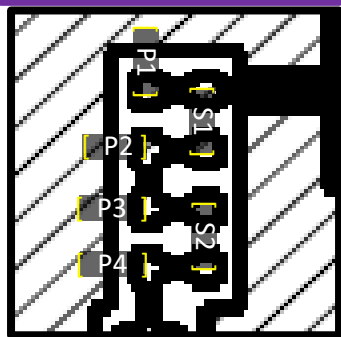

(Antenna Matching): pads are directly inline with the antenna feed trace.

Pin Descriptions

Pin#	Description
1+2	Feed
3	Dummy Pad
4	Dummy Pad
5	Dummy Pad
6	Dummy Pad

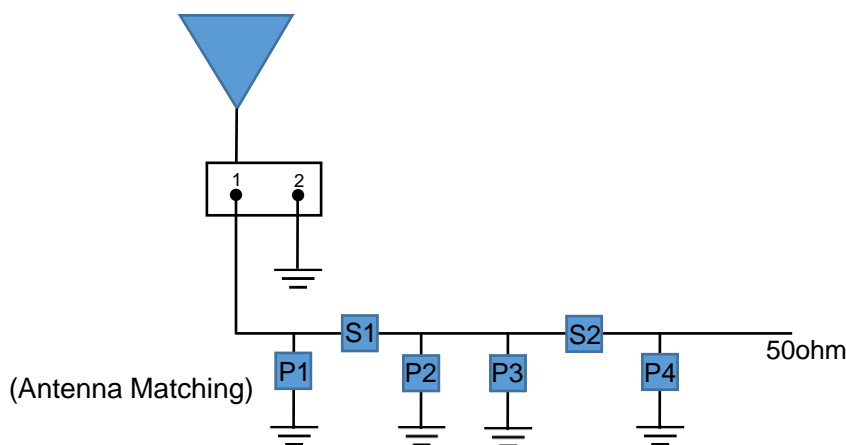

*P822604 uses same matching values

	P1	S1	P2	P3	S2	P4
Default Matching	DNI	2.2pF	10nH	1.0pF	1.5nH	DNI
Part Number	N/A	KAVX 04025J2 R2BBS	LQW15 AN10N G00D	KAVX 04021J1 R0PBS	KAVX L04021 R5AHN	N/A

Universal Broadband Embedded LTE KYOCERA AVX Antenna Specifications.
KYOCERA AVX produces a wide variety of standard and custom antennas to meet user needs.

Antenna Demo Board (P822603-01)

Demo Board Front/Back View (mm)

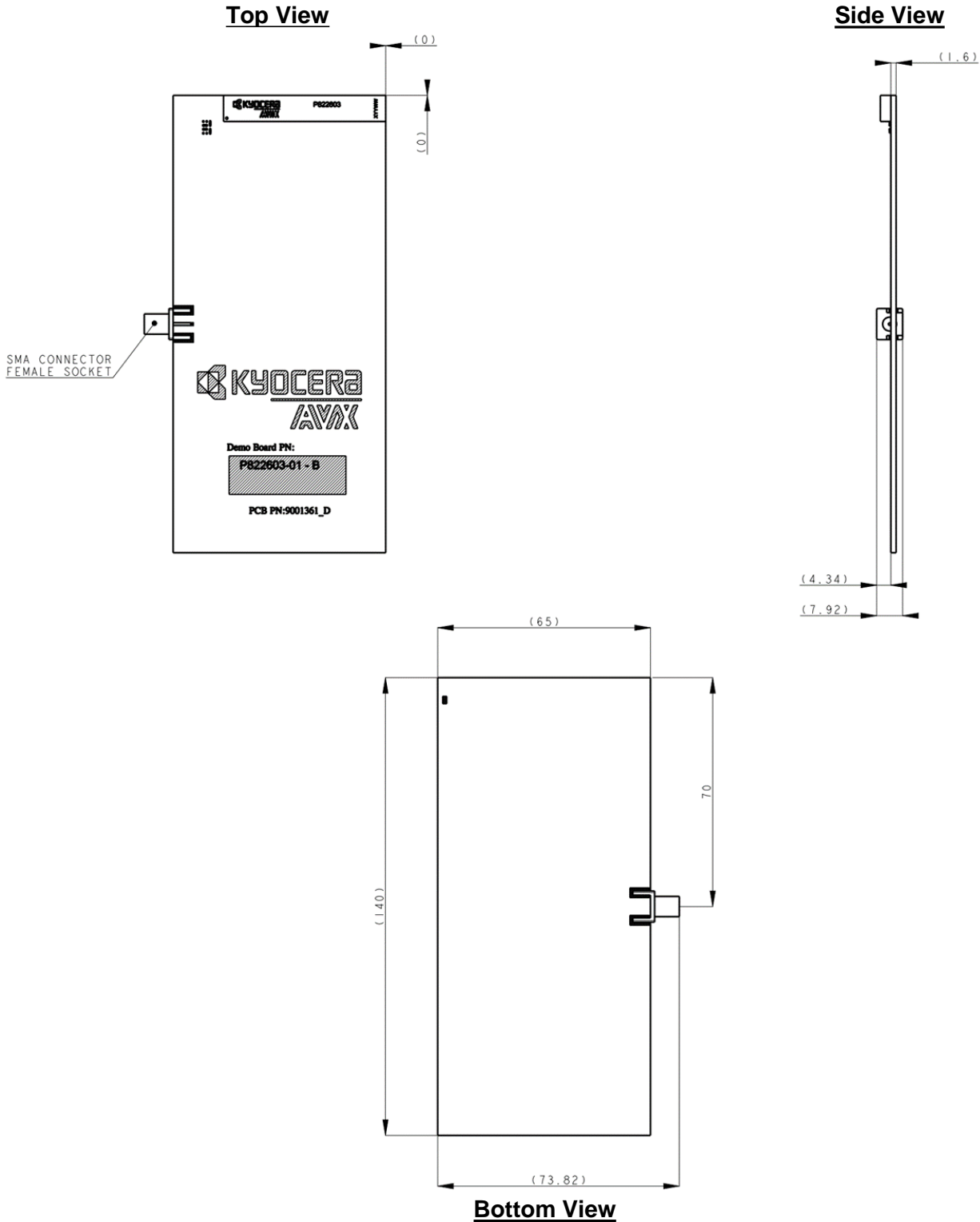

Universal Broadband Embedded LTE KYOCERA AVX Antenna Specifications.
 KYOCERA AVX produces a wide variety of standard and custom antennas to meet user needs.

Antenna layout (P822604-01)
 Typical layout dimensions (mm)

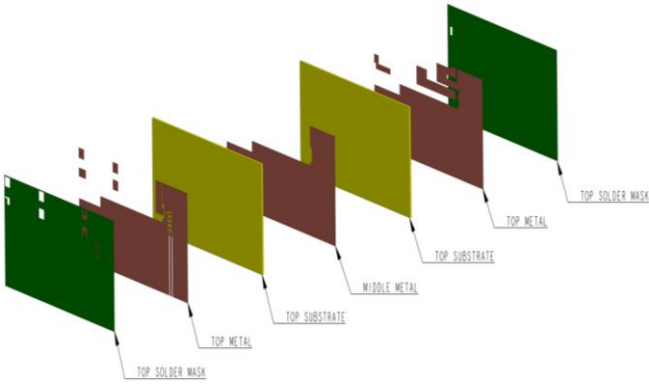

- Additional VIAS: Diam. 0.4mm to be placed around antenna, (no vias on transmission lines).
- Via holes must be covered by solder mask

Pin Descriptions

Pin#	Description
1	Feed
2	Feed
3	Dummy Pad
4	Dummy Pad
5	Dummy Pad
6	Dummy Pad

*P822604 uses the same layout but mirrored.

Default Pi Matching Network values with instructions can be found under Antenna Matching Network.

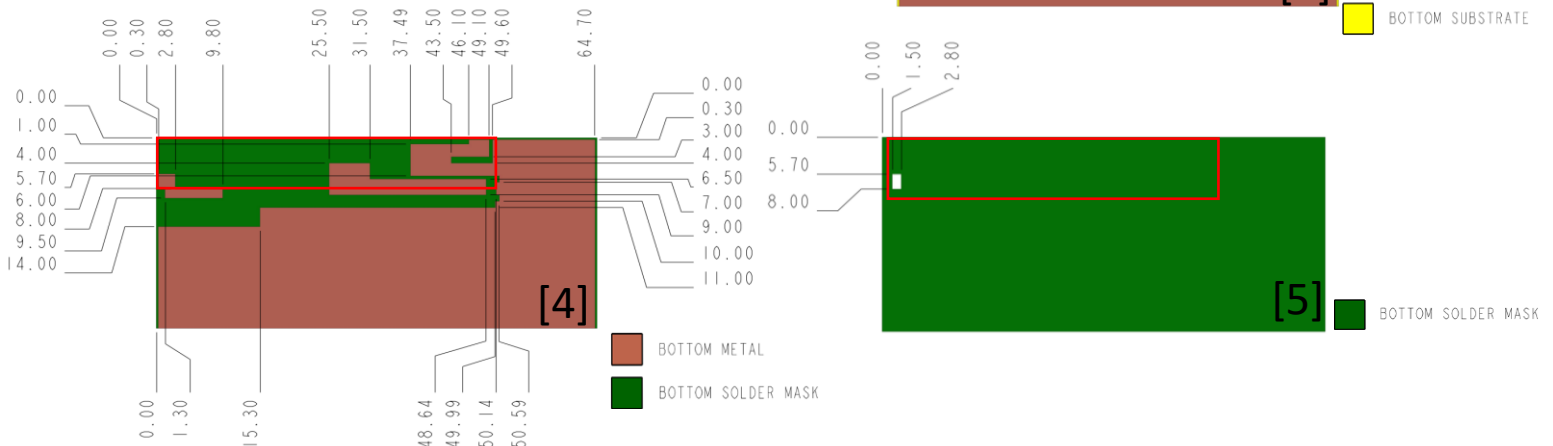

Universal Broadband Embedded LTE KYOCERA AVX Antenna Specifications.
KYOCERA AVX produces a wide variety of standard and custom antennas to meet user needs.

Antenna Matching Structure (P822604)

Typical matching values on 140 x 65 mm PCB

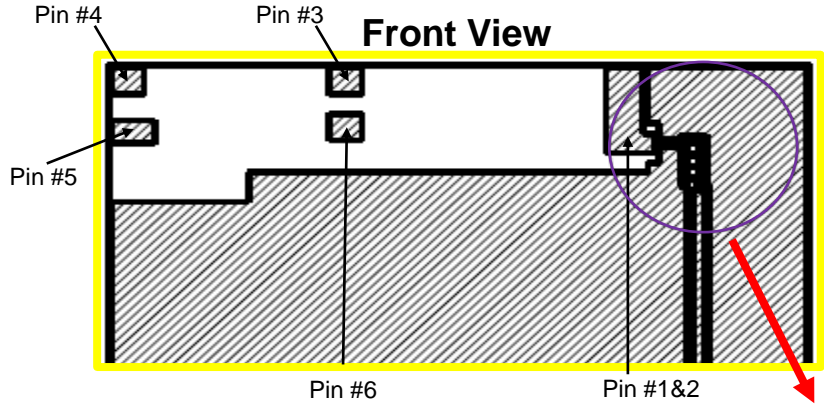

Pin Descriptions

Pin#	Description
1+2	Feed
3	Dummy Pad
4	Dummy Pad
5	Dummy Pad
6	Dummy Pad

Antenna Matching

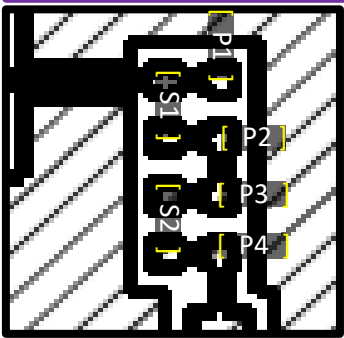

(Antenna Matching):
pads are directly inline with the antenna feed trace.

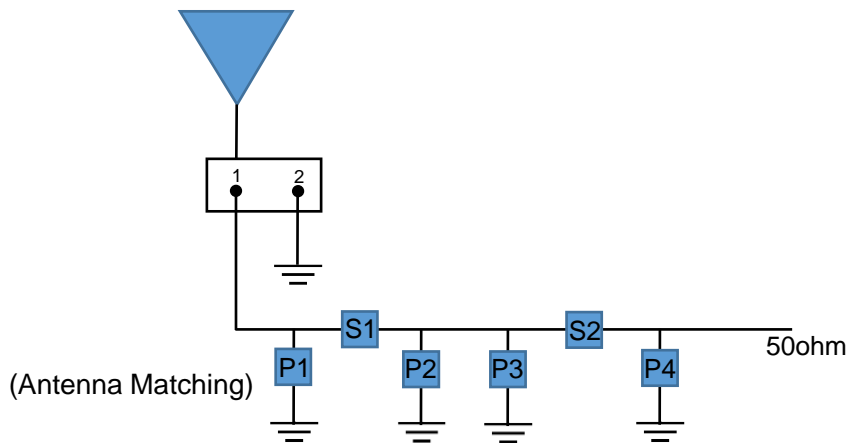

*P822604 uses same matching values

	P1	S1	P2	P3	S2	P4
Default Matching	DNI	2.2pF	10nH	1.0pF	1.5nH	DNI
Part Number	N/A	KAVX 04025J2 R2BBS	LQW15 AN10N G00D	KAVX 04021J1 R0PBS	KAVX L04021 R5AHN	N/A

Universal Broadband Embedded LTE KYOCERA AVX Antenna Specifications.
 KYOCERA AVX produces a wide variety of standard and custom antennas to meet user needs.

Antenna Demo Board (P822604-01)

Demo Board Front/Back View (mm)

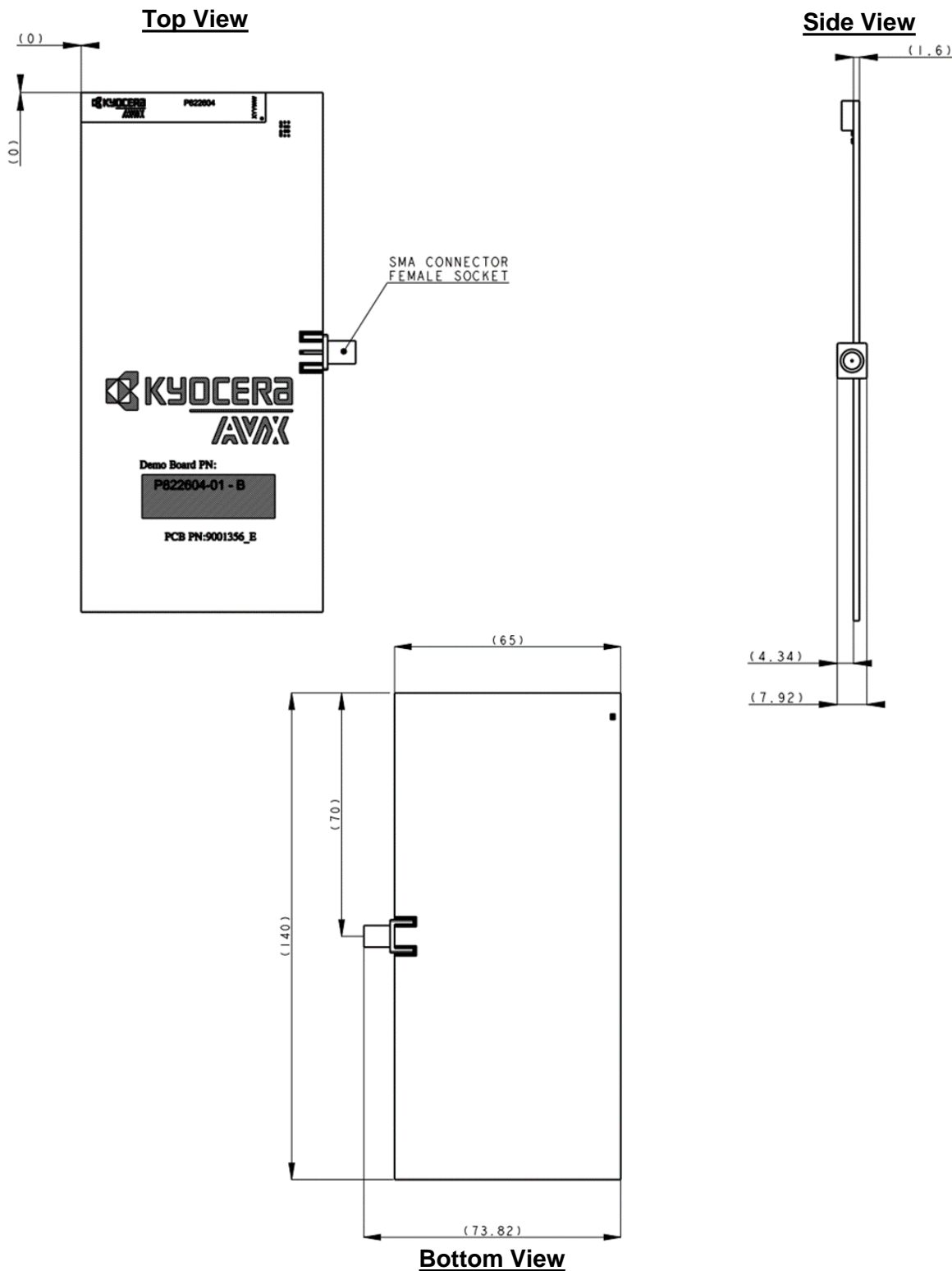

Universal Broadband Embedded LTE KYOCERA AVX Antenna Specifications.
 KYOCERA AVX produces a wide variety of standard and custom antennas to meet user needs.

Recommended Reflow Soldering Profile

The recommended method for soldering the antenna to the board is forced convection reflow soldering. The following suggestions provide information on how to optimize the reflow process for the FR4 antenna:

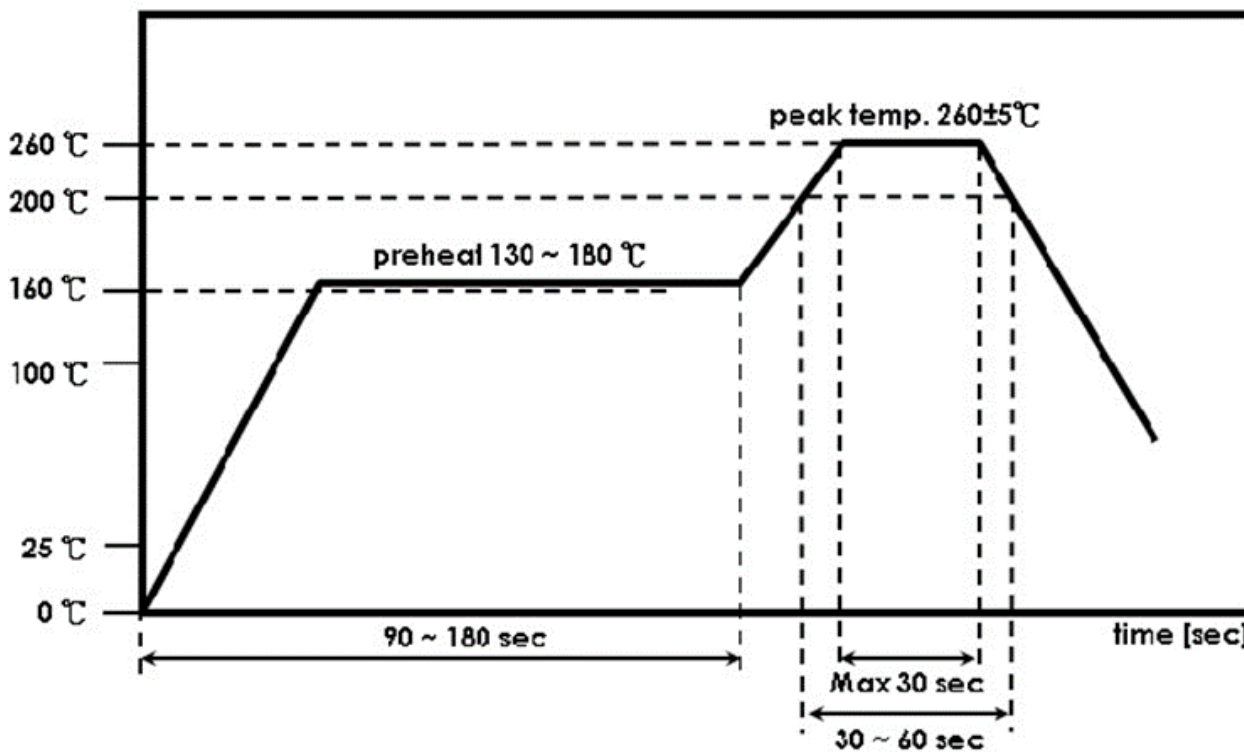

*Adjust the reflow duration to create good solder joints without raising the antenna temperature beyond the allowed maximum of 260° C.

X-ON Electronics

Largest Supplier of Electrical and Electronic Components

Click to view similar products for [Antenna Development Tools](#) category:

Click to view products by [Kyocera AVX](#) manufacturer:

Other Similar products are found below :

[PCSD.06.A](#) [1002427-02](#) [1004796-01](#) [YC0010AAEVB](#) [1001013-02](#) [1005454-01](#) [1004795-01](#) [1002436-01](#) [ACR1004A-EVB](#) [RAC00024-EVB](#) [RAC00245-EVB](#) [ACR1004GC-EVB](#) [W3012-K](#) [W3006-K](#) [SPD.25A](#) [74889100TB](#) [A10192-U1](#) [DTAD.01.A.50](#) [SR4C033-EVB-1](#) [AEK-LTE-CER](#) [IOT-K](#) [SR4W035-EVB-1](#) [W3010-K](#) [LORA-K](#) [ISM-K](#) [REFLECTOR-EVB-1](#) [ACAG0201-2450-EVB](#) [ACAG0301-15752450-EVB](#) [ACAG0301-1575-EVB](#) [ACAG0301-24505500-EVB](#) [ACAG0301-5500-EVB](#) [ACAG0801-2450-EVB](#) [ACAG1204-433-EVB](#) [ACAG1204-868-EVB](#) [ACAG1204-915-EVB](#) [ACAR0301-SW2-EVB](#) [ACAR3005-C2WB-EVB](#) [ACAR3005-S824-EVB](#) [ACAR3705-S698-EVB](#) [ACAR4008-S698-EVB](#) [ACR0301U-EVB](#) [ACR1504I3-EVB-A](#) [ACR1504I3-EVB-S](#) [ACR2005I4-EVB](#) [ACR4006X-EVB](#) [PRO-EB-450](#) [PRO-EB-453](#) [PRO-EB-472](#) [PRO-EB-476](#) [PRO-EB-550](#)