

for Consumer Applications



RoHS Compliant

Features

- Stable oscillation by using fundamental vibration in all frequencies
- Small & low profile
- Built-in capacitor structure
- Reflow solderable

How to Order (PBRC-H, PBRC-M)

PBRC 15.00 H R 50 X 000
 ① ② ③ ④ ⑤ ⑥ ⑦

- ① Series
- ② Frequency (MHz)
- ③ Type (H, M)
- ④ Packing R: Tape & Reel
 PBRC-H (2000 pcs./ Reel)
 PBRC-M (3000 pcs./ Reel)
 (Null): Bulk
- ⑤ Frequency Tolerance at 25°C

10	±0.1%	20	±0.2%
30	±0.3%	40	±0.4%
50	±0.5%	70	±0.7%

- ⑥ Operating Temperature

X -40°C to 85°C

- ⑦ Unique Code

How to Order (PRQC)

PRQC 8.00 C R 50 10 X 000
 ① ② ③ ④ ⑤ ⑥ ⑦ ⑧

- ① Series
- ② Frequency (MHz)
- ③ Type (C, S)
- ④ Packing R: Tape & Reel (3000 pcs./ Reel)
 (Null): Bulk
- ⑤ Frequency Tolerance at 25°C

30	±0.3%	40	±0.4%
50	±0.5%	70	±0.7%

- ⑥ Built-in Capacitance 10pF: 10 5pF: 05

- ⑦ Operating Temperature

W -20°C to 80°C **X** -40°C to 85°C

- ⑧ Unique Code

Specifications

Series	Frequency Range (MHz)	Frequency Tolerance (25°C)	Temperature Stability	Operating Temperature Range (°C)
PBRC-HR	2.0 to 8.0	±0.50%	±0.30%	-40 to 85
	8.1 to 20.0	±0.50%	±0.10%	-40 to 85
PBRC-MR	8.0 to 20.0	±0.50%	±0.10%	-40 to 85
	4.0 to 10.0	±0.50%	±0.30%	-40 to 85
PRQC	8.0 to 20.0	±0.50%	±0.50%	-40 to 85
	10.1 to 20.0	±0.50%	±0.50%	-40 to 85

Test Circuit

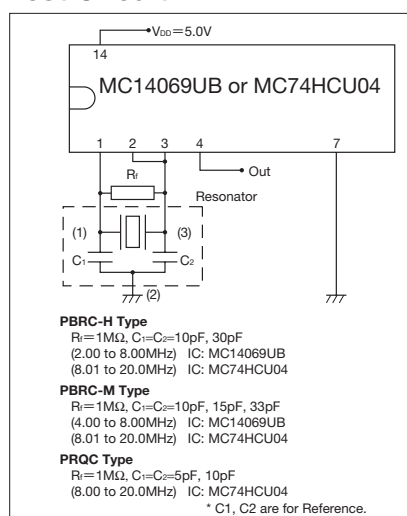

Note)

- This product includes built-in capacitors, but values may not be the most appropriate depending on IC's.
- Evaluation of circuit with IC is necessary. IC circuit matching may be referenced with
 - 1) IC data books
 - 2) List of Recommended circuits in Kyocera website.
- Please contact IC manufacturer or Kyocera when there are difficulties in finding recommended circuits.

Dimensions

(Unit: mm)

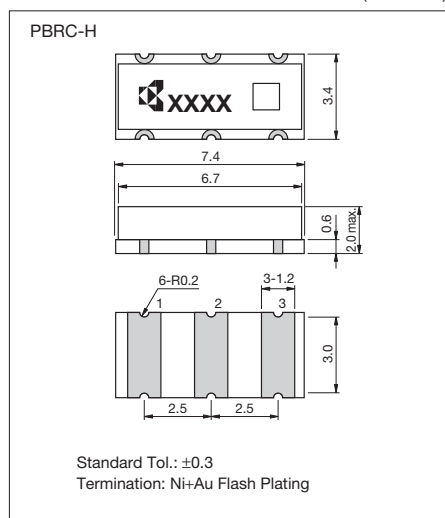

(Unit: mm)

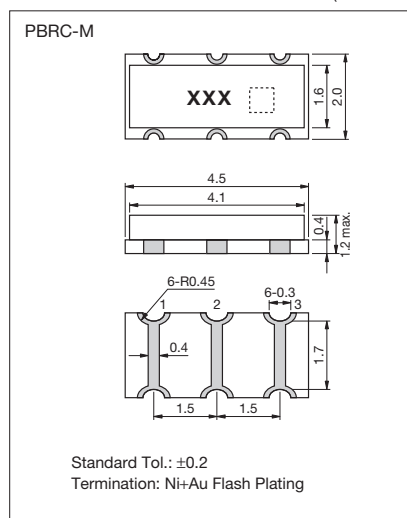

(Unit: mm)

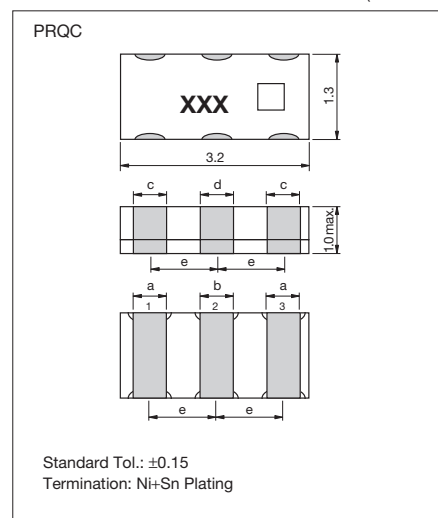

(Unit: mm)

Type	Frequency (MHz)	a	b	c	d	e
C	8.00 to 20.00	0.4	0.4	0.6	0.4	1.2
S	14.00 to 20.00	0.6	0.4	0.6	0.4	0.95

X-ON Electronics

Largest Supplier of Electrical and Electronic Components

Click to view similar products for [Resonators](#) category:

Click to view products by [Kyocera AVX](#) manufacturer:

Other Similar products are found below :

[B39431R820H210](#) [CSAC2.00MGCM-TC](#) [ECS-HFR-40.00-B-TR](#) [CSTLS4M00G53Z-A0](#) [ECS-CR2-16.00-A-TR](#) [ECS-HFR-20.00-B-TR](#)
[ECS-CR2-20.00-A-TR](#) [RO3164E-3](#) [CSTNE14M7V510000R0](#) [7D038400I01](#) [7B009843R01](#) [NX2012SA](#) [32.768KHZ](#) [STD-MUB-1](#)
[NX3215SA](#) [32.768KHZ](#) [STD-MUS-2](#) [7B009843M01](#) [OZ26030001](#) [Q22FA12800519](#) [CSTCR4M00G55E-R0](#) [XC32M4-37.400-F16NLDT](#)
[CSTLS24M0X53-B0](#) [AWSCR-10.00CELB-C10-T3](#) [AWSCR-12.00CELA-C33-T3](#) [AWSCR-2.00CPLB-C15-T4](#) [AWSCR-3.58CPLA-C30-T4](#)
[AWSCR-3.58CPLB-C30-T4](#) [AWSCR-4.00CPLA-C33-T4](#) [AWSCR-4.00CPLB-C10-T4](#) [AWSCR-4.00CRLA-C39-T3](#) [AWSCR-4.19CPLA-](#)
[C30-T4](#) [AWSCR-4.19CRLA-C15-T3](#) [AWSCR-4.19CRLB-C15-T3](#) [AWSCR-4.91CRLB-C15-T3](#) [AWSCR-5.00CPLA-C30-T4](#) [AWSCR-](#)
[5.00CPLB-C30-T4](#) [AWSCR-5.00CRLA-C15-T3](#) [AWSCR-5.00CRLA-C39-T3](#) [AWSCR-5.00CRLB-C15-T3](#) [AWSCR-7.37CPLA-C30-T4](#)
[AWSCR-7.37CPLB-C30-T4](#) [9AC04194152080D2JB](#) [CSTCR4M91G55B-R0](#) [CSTLS3M68G56-B0](#) [FC-12M32.768KHZ9PF20PPM](#)
[ASR433.42E-T](#) [X1A0000910001](#) [ECS-SR1-4.19-B-TR](#) [7C024000HW1](#) [7C012000IW1](#) [7C012000MW1](#) [7C016000HW1](#) [7C016000MW1](#)