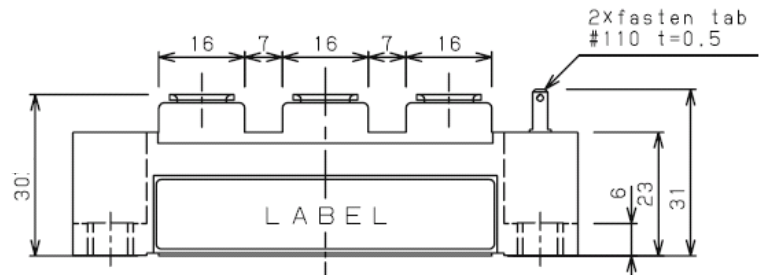
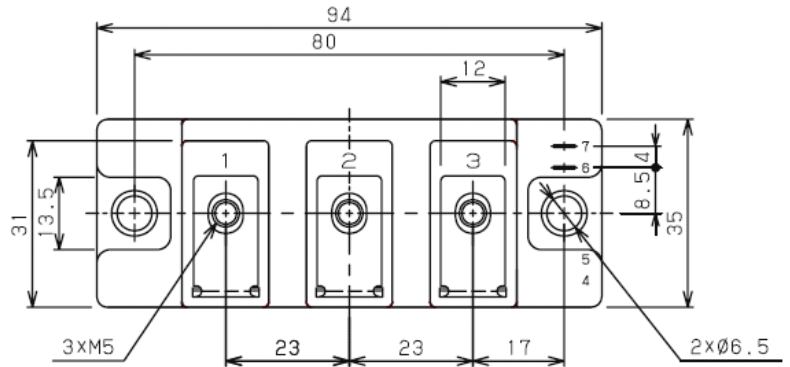
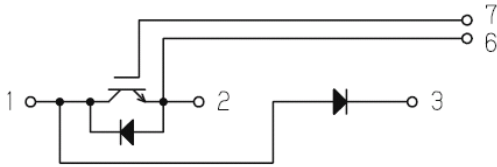

□ 回路図 : *CIRCUIT*

 □ 概略図 : *SCHEMATIC DIAGRAM*

Dimension: [mm]

 □ 最大定格 : *MAXIMUM RATINGS* (at $T_c=25^\circ\text{C}$ unless otherwise specified)

| Item | | Symbol | Condition | Rated Value | Unit |
|--|---|-------------------------|-------------------------------------|-----------------|------------------|
| IGBT | コレクタ・エミッタ間電圧 Collector-Emitter Voltage | V_{CES} | G-E Short | 650 | V |
| | ゲート・エミッタ間電圧 Gate-Emitter Voltage | V_{GES} | C-E Short | ± 20 | V |
| | コレクタ電流 Collector Current | I_C | DC $T_c=85^\circ\text{C}$ | 150 | A |
| | | I_{CP} | Pulse $\leq 1\text{ms}$ | 300 | |
| コレクタ損失 Collector Power Dissipation | P_C | $T_j=175^\circ\text{C}$ | 536 | W | |
| | | $T_j=150^\circ\text{C}$ | 446 | | |
| FWD | 繰り返しピーク逆電圧 Repetitive peak reverse voltage | V_{RRM} | | 650 | V |
| | 順電流 Forward Current | I_F | | 150 | A |
| | | I_{FM} | Pulse $\leq 1\text{ms}$ | 300 | |
| 最大接合温度 Maximum Junction Temperature | | T_{jMAX} | 瞬時動作(過負荷) Instantaneous Overload | 175 | $^\circ\text{C}$ |
| 接合温度範囲 Junction Temperature Range | | T_j | | $-40 \sim +150$ | $^\circ\text{C}$ |
| 保存温度範囲 Storage Temperature Range | | T_{stg} | | $-40 \sim +125$ | $^\circ\text{C}$ |
| 絶縁耐圧 Isolation Voltage | | V_{ISO} | Terminal to Base AC, 1minute | 2,500 | V (RMS) |
| 締め付けトルク Mounting Torque | Module Base to Heatsink | F_{tor} | M6 | 3 | N · m |
| | Busbar to Main Terminal | | M5 | 2 | |

□ 電 氣 的 特 性 : **ELECTRICAL CHARACTERISTICS** (at $T_J=25^\circ\text{C}$ unless otherwise specified)

| Characteristic | | Symbol | Test Condition | Min. | Typ. | Max. | Unit | |
|------------------------------------|--|-----------|--|-------------------------|------|------|---------------|---|
| IGBT | コレクタ遮断電流 Collector-Emitter Cut-Off Current | ICES | $V_{CE}=650V, V_{GE}=0V$ | — | — | 1.0 | mA | |
| | ゲート漏れ電流 Gate-Emitter Leakage Current | IGES | $V_{GE}=\pm 20V, V_{CE}=0V$ | — | — | 1.0 | μA | |
| | コレクタ・エミッタ間飽和電圧 Collector-Emitter Saturation Voltage | VCE(sat.) | $I_c=150A, V_{GE}=15V$ (chip level) | $T_J=25^\circ\text{C}$ | — | 1.45 | 1.95 | V |
| | | | | $T_J=125^\circ\text{C}$ | — | 1.65 | — | |
| | | | | $T_J=150^\circ\text{C}$ | — | 1.70 | — | |
| | ゲートしきい値電圧 Gate-Emitter Threshold Voltage | VGE(th.) | $V_{CE}=10V, I_c=3mA$ | 4.8 | — | 7.0 | V | |
| | 入力容量 Input Capacitance | Cies | $V_{CE}=25V, V_{GE}=0V, f=1MHz$ | — | 12.5 | — | nF | |
| | 出力容量 Output Capacitance | Coes | | — | 0.5 | — | | |
| | 帰還容量 Reverse Transfer Capacitance | Cres | | — | 0.4 | — | | |
| | ゲート電荷量 Gate Charge | Qg | $V_{CC}=300V, I_c=150A, V_{GE}=-15\sim+15V$ | — | 1275 | — | nC | |
| スイッチング時間 Switching Time | 上昇時間 Rise Time | tr | $V_{CC}=300V, L_s=38nH$ $I_c=150A$ Inductive Load $R_G=5.1\Omega$ $V_{GE}=\pm 15V$ $T_J=150^\circ\text{C}$ | — | 71 | — | ns | |
| | ターンオン遅延時間 Turn-on Delay Time | td(on) | | — | 119 | — | | |
| | 下降時間 Fall Time | tf | | — | 70 | — | | |
| | ターンオフ遅延時間 Turn-off Delay Time | td(off) | | — | 300 | — | | |
| FWD | 順電圧 Peak Forward Voltage | V_F | $I_F=150A, V_{GE}=0V$ (chip level) | $T_J=25^\circ\text{C}$ | — | 1.70 | 2.20 | V |
| | 逆回復時間 Reverse Recovery Time | trr | | $T_J=125^\circ\text{C}$ | — | 1.60 | — | |
| $T_J=150^\circ\text{C}$ | | | | — | 1.55 | — | | |
| 内部配線抵抗 Internal Lead Resistance | | RCC+EE' | 主端子—チップ間 / 1素子 Main Terminal - Chip / Per 1 Arm | — | — | 1 | m Ω | |
| 内部インダクタンス Stray Inductance | | LSCE | メイン端子3—2間 Main Terminal 3 - Main Terminal 2 | — | 30 | — | nH | |

□ 熱 的 特 性 : **THERMAL CHARACTERISTICS**

| Characteristic | | Symbol | Test Condition | Min. | Typ. | Max. | Unit |
|---------------------------------|------|----------|--|------|------|------|------|
| 熱 抵 抗 Thermal Resistance | IGBT | Rth(j-c) | Junction to Case Per 1 Arm (Tc測定点: チップ直下) | — | — | 0.28 | °C/W |
| | FWD | | | — | — | 0.67 | |
| 接 触 熱 抵 抗 Thermal Resistance | IGBT | Rth(c-f) | Case to heatsink Per 1 Arm Paste=1W/(m ² °C) | — | 0.10 | — | |
| | FWD | | | — | 0.17 | — | |

□ 特性图 : CHARACTERISTICS CURVES

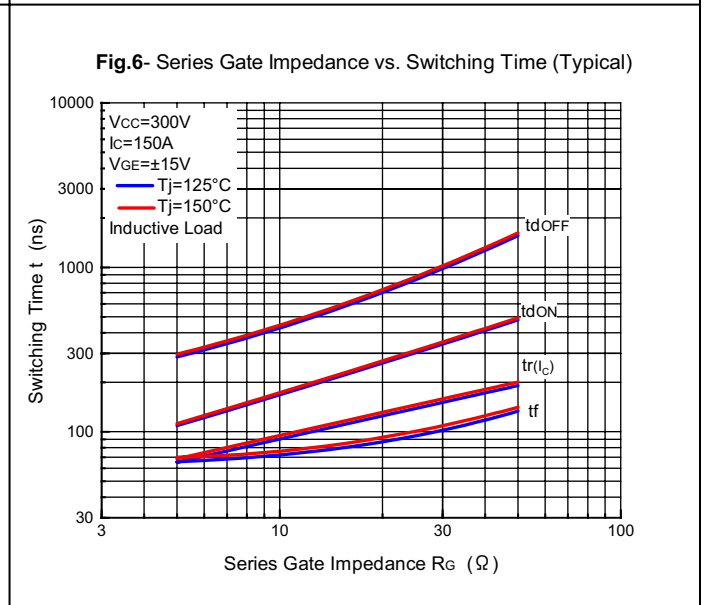
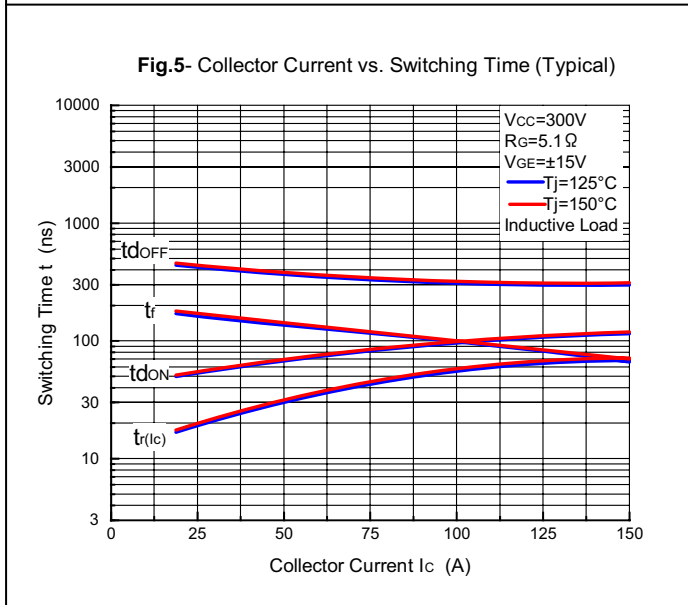
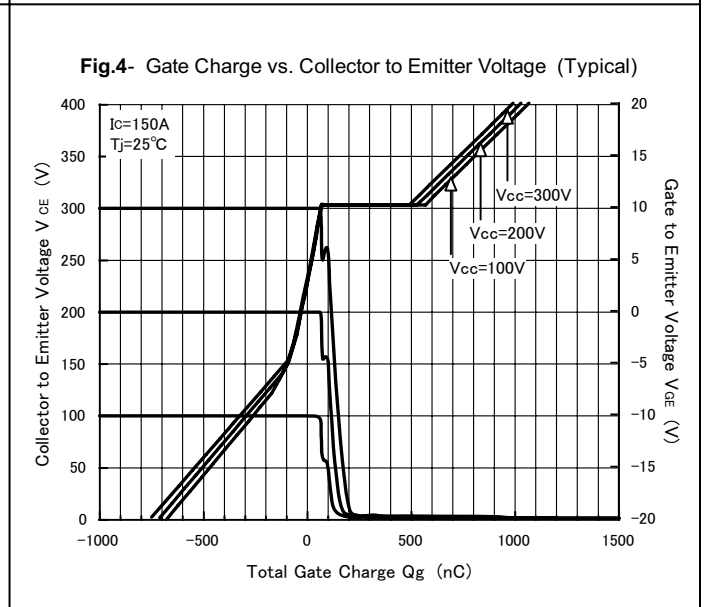
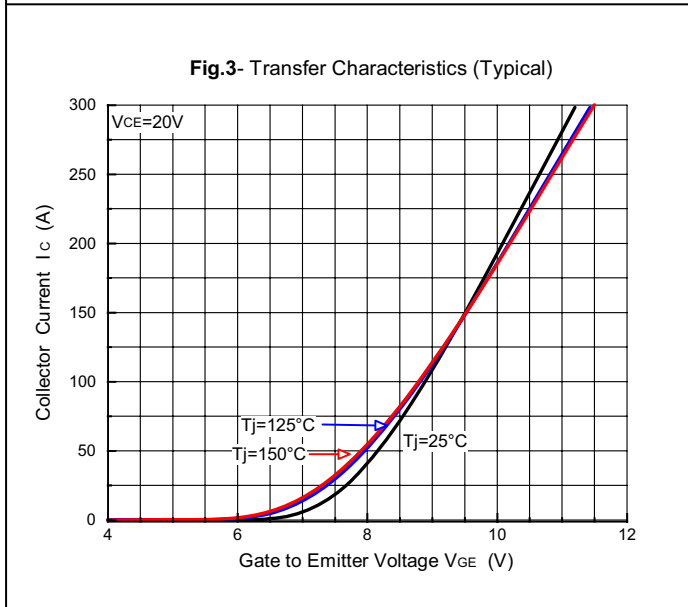
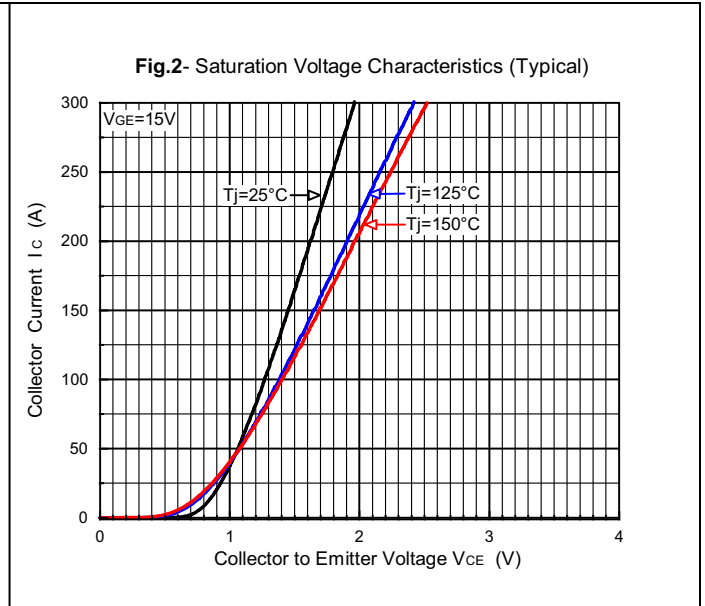
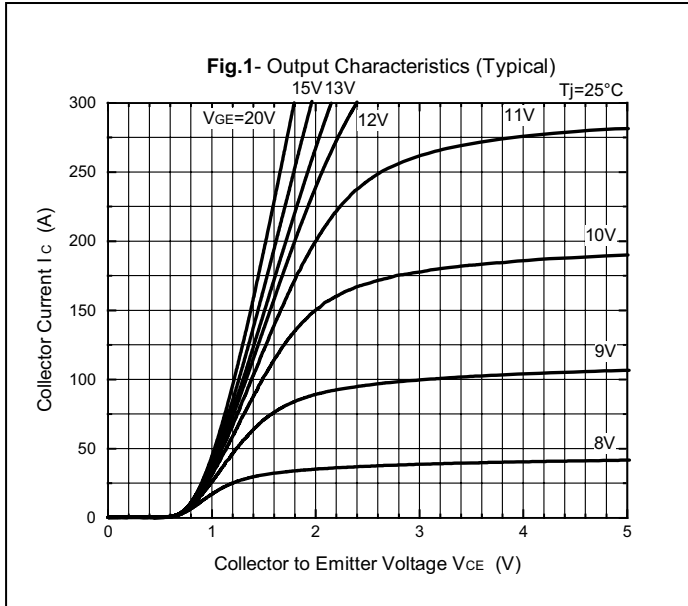

特性 : CHARACTERISTICS CURVES

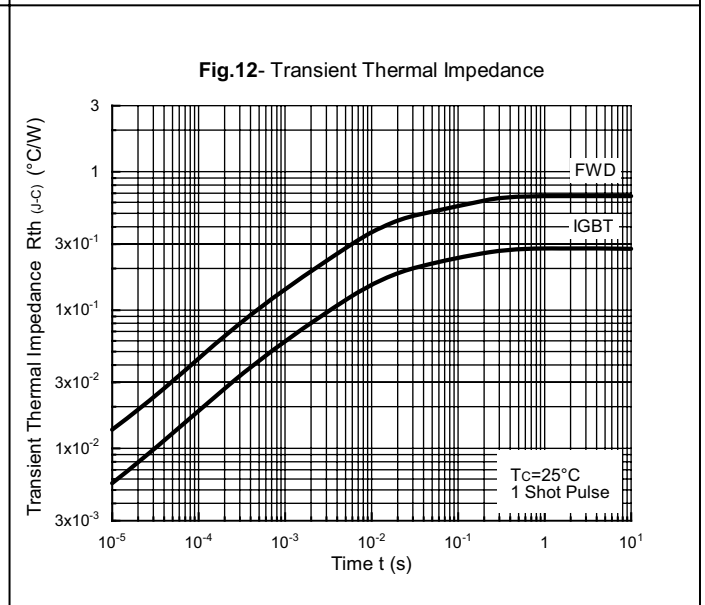
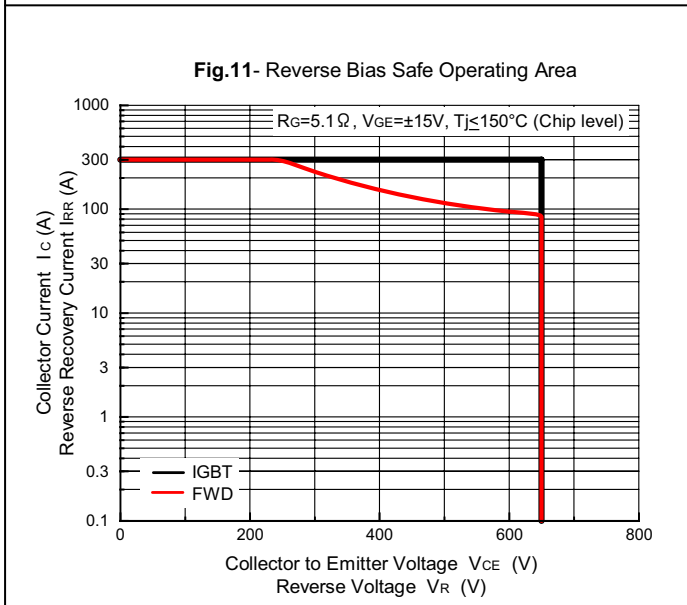
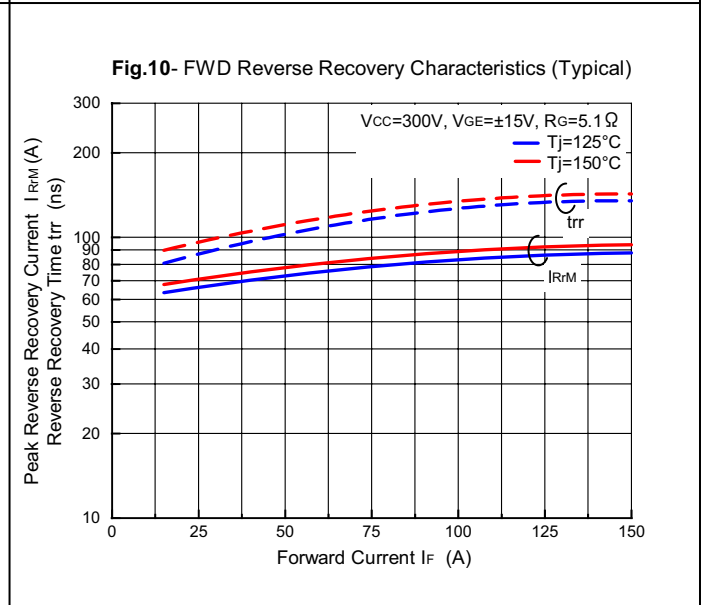
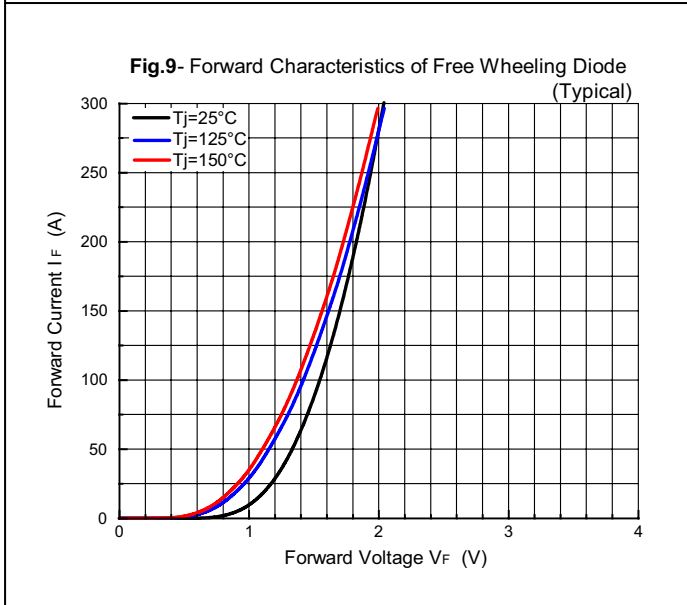
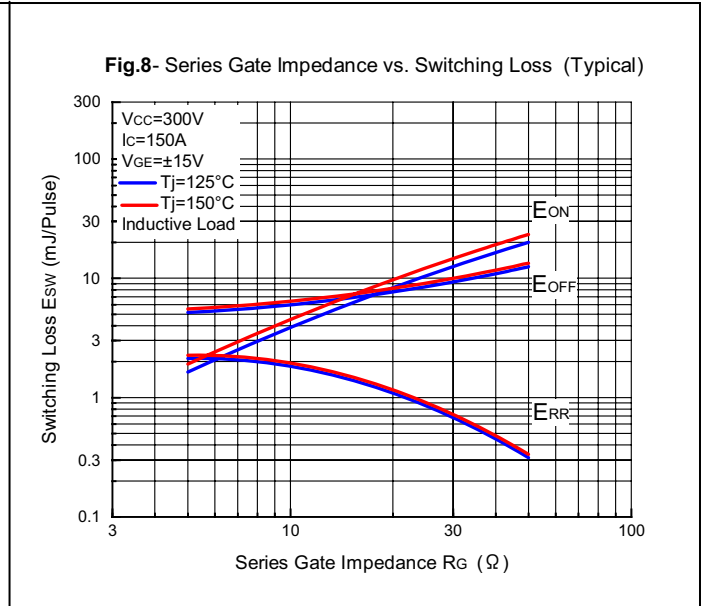
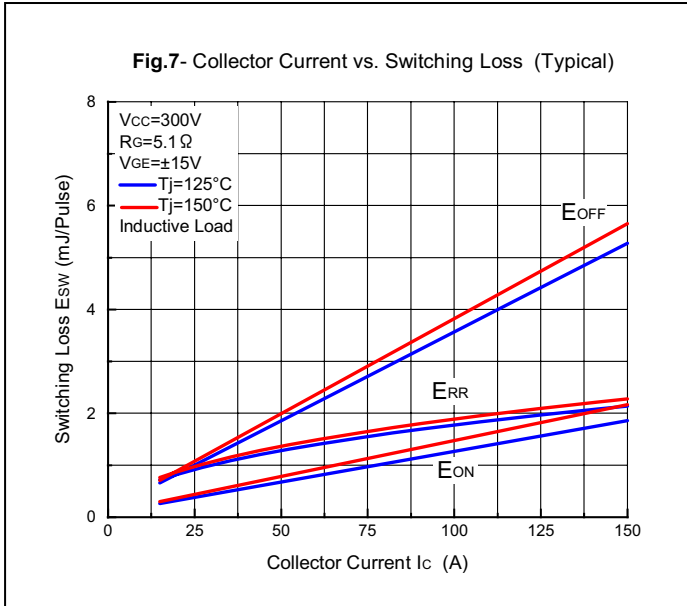

X-ON Electronics

Largest Supplier of Electrical and Electronic Components

Click to view similar products for [IGBT Modules category](#):

Click to view products by [Kyocera AVX manufacturer](#):

Other Similar products are found below :

[F3L400R07ME4_B22](#) [F3L400R12PT4_B26](#) [FB20R06W1E3_B11](#) [FD300R12KE3](#) [FD300R12KS4_B5](#) [FD400R12KE3](#) [FF100R12KS4](#)
[FF150R12KE3G](#) [FF200R06KE3](#) [FF200R06YE3](#) [FF300R06KE3_B2](#) [FF600R12IP4V](#) [FF800R17KP4_B2](#) [FF900R12IE4V](#)
[FP06R12W1T4_B3](#) [FP100R07N3E4](#) [FP100R07N3E4_B11](#) [FP10R06W1E3_B11](#) [FP10R12W1T4_B11](#) [FP10R12YT3](#) [FP15R12W2T4](#)
[FP15R12YT3](#) [FP20R06W1E3](#) [FP30R06W1E3](#) [FP40R12KT3G](#) [FP75R06KE3](#) [FS10R12YE3](#) [FS150R07PE4](#) [FS150R12PT4](#)
[FS150R17N3E4_B11](#) [FS20R06W1E3_B11](#) [FS30R06W1E3_B11](#) [FS75R12KE3G](#) [FS75R12W2T4_B11](#) [FZ1600R17HP4_B2](#)
[FZ300R12KE3G](#) [FZ400R17KE3](#) [FZ400R17KE4](#) [FZ600R65KE3](#) [DF1000R17IE4D_B2](#) [APTGT75DA60T1G](#) [DZ800S17K3](#) [F12-](#)
[25R12KT4G](#) [F3L200R12W2H3_B11](#) [F3L300R12ME4_B22](#) [F3L75R07W2E3_B11](#) [F4-150R12KS4](#) [F475R07W1H3B11ABOMA1](#)
[FD1400R12IP4D](#) [FD400R12KE3_B5](#)