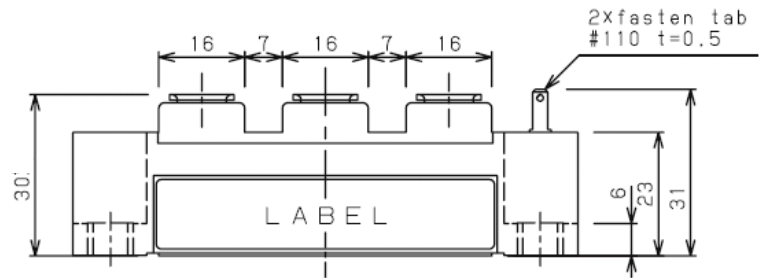
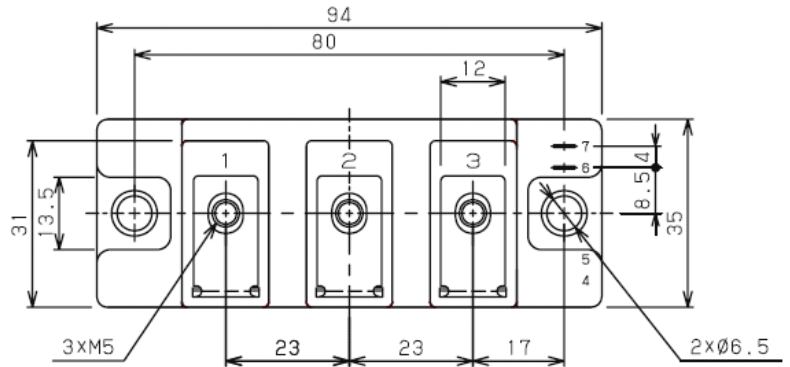
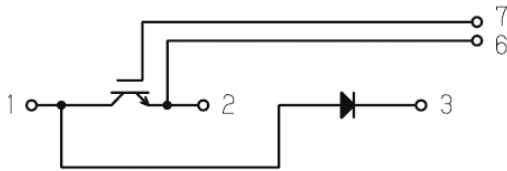

□ 回路図 : *CIRCUIT*

 □ 概略図 : *SCHEMATIC DIAGRAM*

Dimension: [mm]

 □ 最大定格 : *MAXIMUM RATINGS* (at  $T_c=25^\circ\text{C}$  unless otherwise specified)

Item		Symbol	Condition	Rated Value	Unit
IGBT	コレクタ・エミッタ間電圧 Collector-Emitter Voltage	$V_{CES}$	G-E Short	650	V
	ゲート・エミッタ間電圧 Gate-Emitter Voltage	$V_{GES}$	C-E Short	$\pm 20$	V
	コレクタ電流 Collector Current	$I_C$	DC $T_c=85^\circ\text{C}$	200	A
		$I_{CP}$	Pulse $\leq 1\text{ms}$	400	
コレクタ損失 Collector Power Dissipation	$P_C$	$T_j=175^\circ\text{C}$	714	W	
		$T_j=150^\circ\text{C}$	595		
FWD	繰り返しピーク逆電圧 Repetitive peak reverse voltage	$V_{RRM}$		650	V
	順電流 Forward Current	$I_F$		200	A
		$I_{FM}$	Pulse $\leq 1\text{ms}$	400	
最大接合温度 Maximum Junction Temperature		$T_{jMAX}$	瞬時動作(過負荷) Instantaneous Overload	175	$^\circ\text{C}$
接合温度範囲 Junction Temperature Range		$T_j$		$-40 \sim +150$	$^\circ\text{C}$
保存温度範囲 Storage Temperature Range		$T_{stg}$		$-40 \sim +125$	$^\circ\text{C}$
絶縁耐圧 Isolation Voltage		$V_{ISO}$	Terminal to Base AC, 1minute	2,500	V (RMS)
締め付けトルク Mounting Torque	Module Base to Heatsink	$F_{tor}$	M6	3	N · m
	Busbar to Main Terminal		M5	2	

□ 電 氣 的 特 性 : **ELECTRICAL CHARACTERISTICS** (at  $T_J=25^\circ\text{C}$  unless otherwise specified)

Characteristic		Symbol	Test Condition	Min.	Typ.	Max.	Unit		
IGBT	コレクタ遮断電流 Collector-Emitter Cut-Off Current	ICES	$V_{CE}=650\text{V}, V_{GE}=0\text{V}$	—	—	1.0	mA		
	ゲート漏れ電流 Gate-Emitter Leakage Current	IGES	$V_{GE}=\pm 20\text{V}, V_{CE}=0\text{V}$	—	—	1.0	$\mu\text{A}$		
	コレクタ・エミッタ間飽和電圧 Collector-Emitter Saturation Voltage	$V_{CE(sat.)}$	$I_C=200\text{A}, V_{GE}=15\text{V}$ (chip level)	$T_J=25^\circ\text{C}$ $T_J=125^\circ\text{C}$ $T_J=150^\circ\text{C}$	— — —	1.45 1.65 1.70	1.95 — —	V	
	ゲートしきい値電圧 Gate-Emitter Threshold Voltage	$V_{GE(th.)}$	$V_{CE}=10\text{V}, I_C=4\text{mA}$		4.8	—	7.0	V	
	入力容量 Input Capacitance	$C_{ies}$	$V_{CE}=25\text{V}, V_{GE}=0\text{V}, f=1\text{MHz}$		—	17.0	—	nF	
	出力容量 Output Capacitance	$C_{oes}$			—	0.7	—		
	帰還容量 Reverse Transfer Capacitance	$C_{res}$			—	0.6	—		
	ゲート電荷量 Gate Charge	Qg	$V_{CC}=300\text{V}, I_C=200\text{A}, V_{GE}=-15\sim+15\text{V}$		—	1700	—	nC	
	スイッチング時間 Switching Time	上昇時間 Rise Time	$t_r$	$V_{CC}=300\text{V}$ $I_C=200\text{A}$ $R_G=3.6\Omega$ $V_{GE}=\pm 15\text{V}$ $T_J=150^\circ\text{C}$	$L_s=38\text{nH}$ Inductive Load	—	66	—	ns
		ターンオン遅延時間 Turn-on Delay Time	$t_d(on)$		—	110	—		
下降時間 Fall Time		$t_f$		—	68	—			
ターンオフ遅延時間 Turn-off Delay Time		$t_d(off)$		—	290	—			
FWD	順電圧 Peak Forward Voltage	$V_F$	$I_F=200\text{A}, V_{GE}=0\text{V}$ (chip level)	$T_J=25^\circ\text{C}$ $T_J=125^\circ\text{C}$ $T_J=150^\circ\text{C}$	— — —	1.70 1.60 1.55	2.20 — —	V	
	逆回復時間 Reverse Recovery Time	$t_{rr}$	$V_{CC}=300\text{V}$ $I_C=200\text{A}$ $R_G=3.6\Omega$ $V_{GE}=\pm 15\text{V}$ $T_J=150^\circ\text{C}$	$L_s=38\text{nH}$ Inductive Load	—	145	—	ns	
内部配線抵抗 Internal Lead Resistance		$R_{CC+EE}$	主端子—チップ間 / 1素子 Main Terminal - Chip / Per 1 Arm		—	—	1	$\text{m}\Omega$	
内部インダクタンス Stray Inductance		LSCE	メイン端子3—2間 Main Terminal 3 - Main Terminal 2		—	30	—	nH	

 □ 熱 的 特 性 : **THERMAL CHARACTERISTICS**

Characteristic		Symbol	Test Condition	Min.	Typ.	Max.	Unit
熱 抵 抗 Thermal Resistance	IGBT	$R_{th(j-c)}$	Junction to Case Per 1 Arm (Tc測定点: チップ直下)	—	—	0.21	$^\circ\text{C}/\text{W}$
	FWD			—	—	0.48	
接 触 熱 抵 抗 Thermal Resistance	IGBT	$R_{th(c-f)}$	Case to heatsink Per 1 Arm Paste=1W/(m <sup>2</sup> °C)	—	0.10	—	
	FWD			—	0.17	—	

特性图 : CHARACTERISTICS CURVES

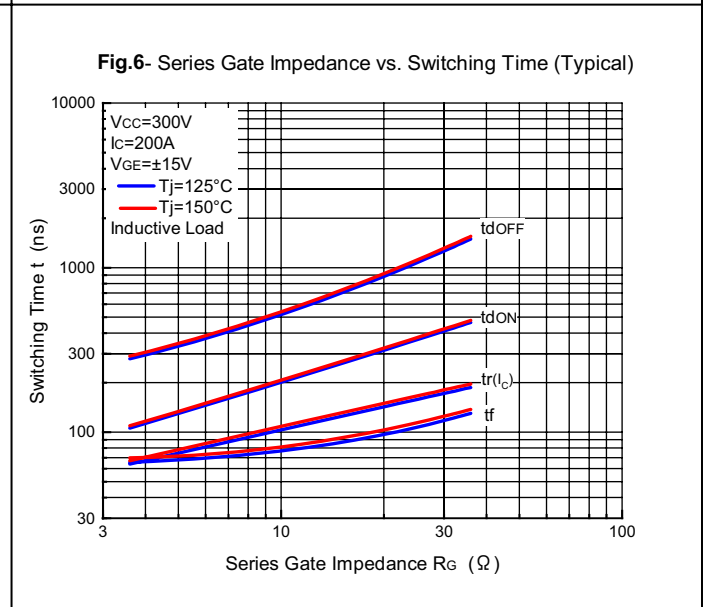
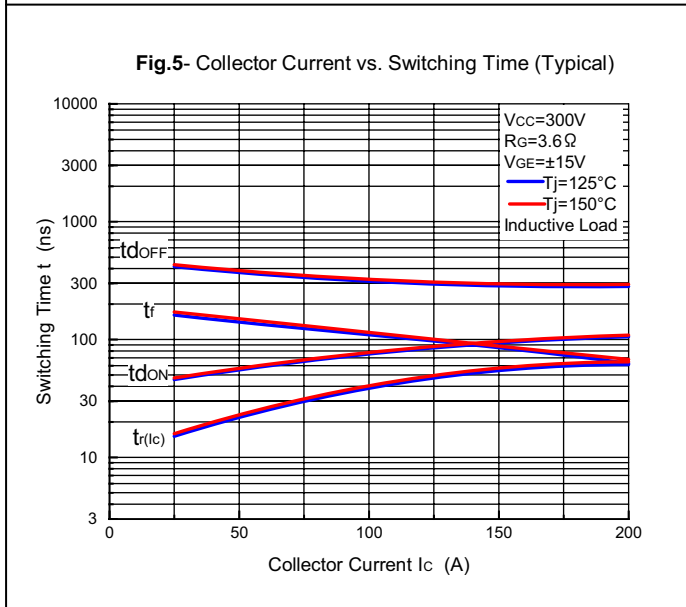
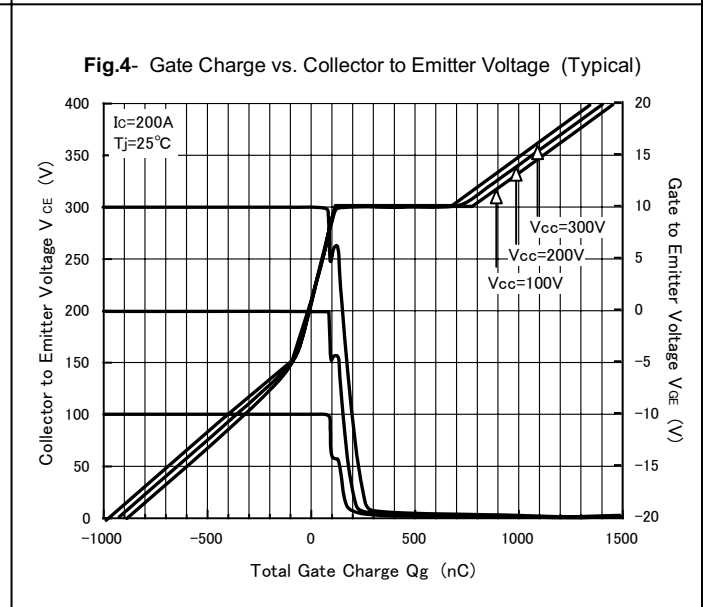
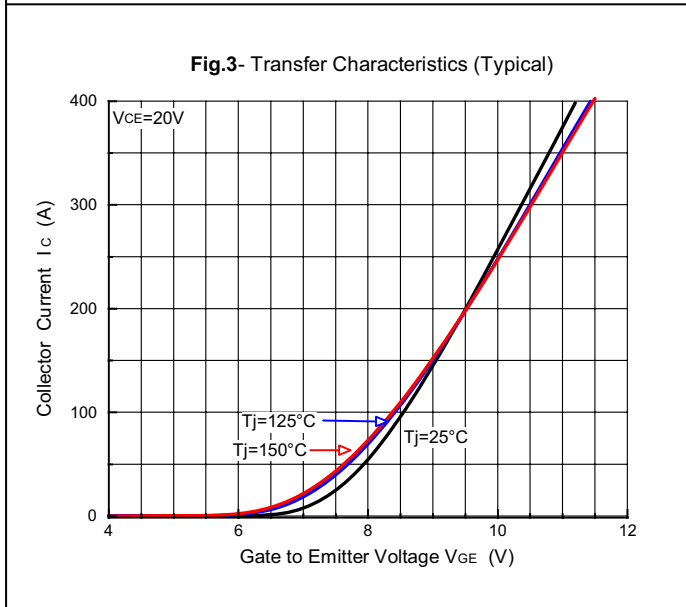
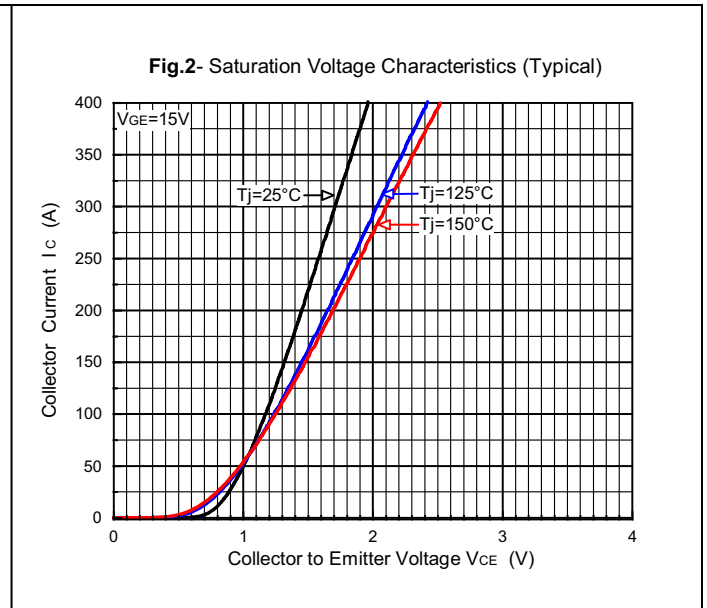
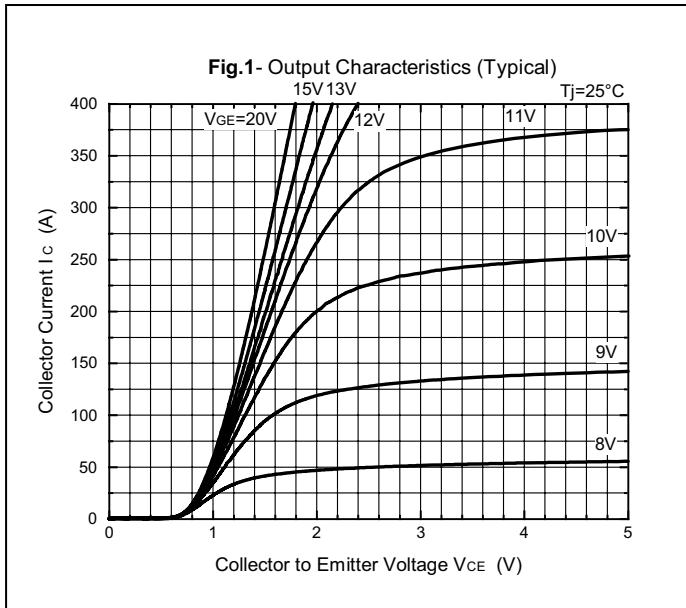

特性 : CHARACTERISTICS CURVES

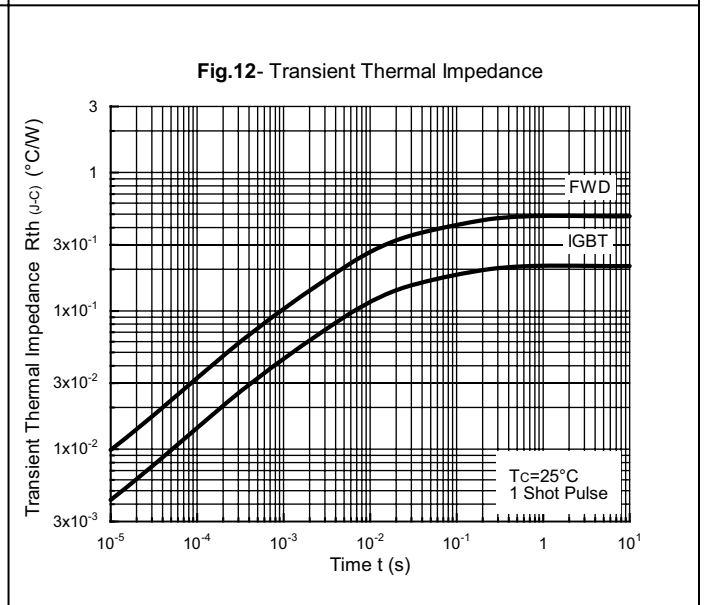
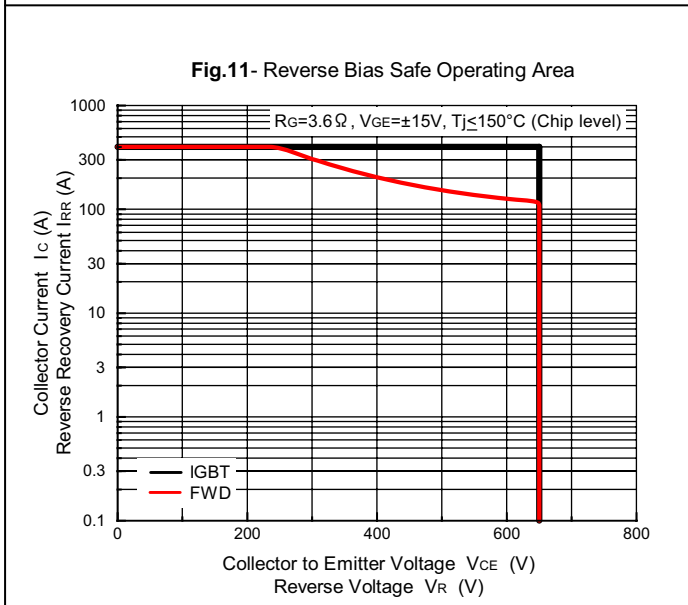
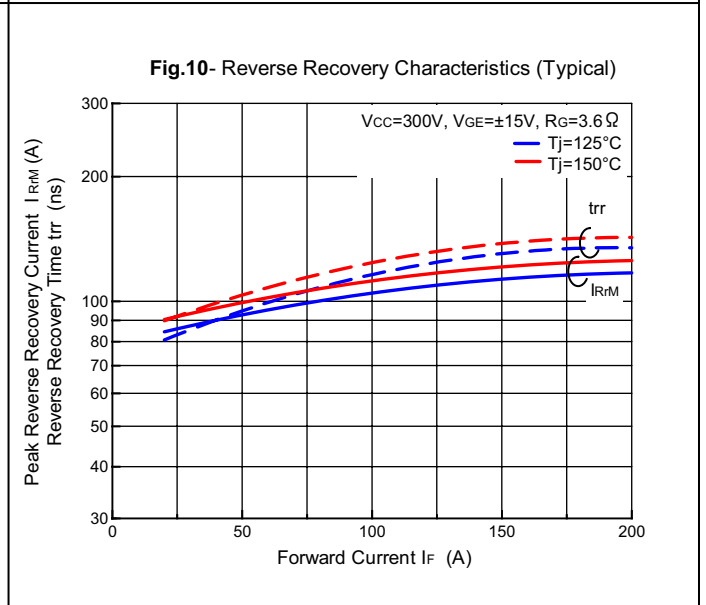
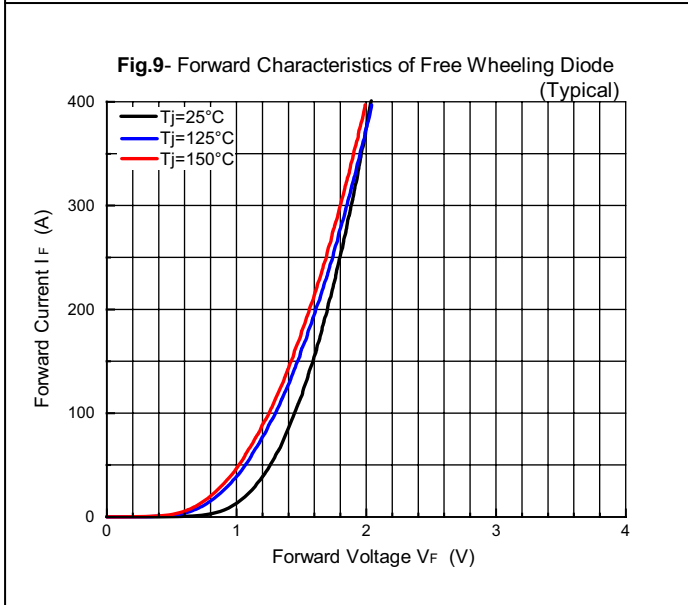
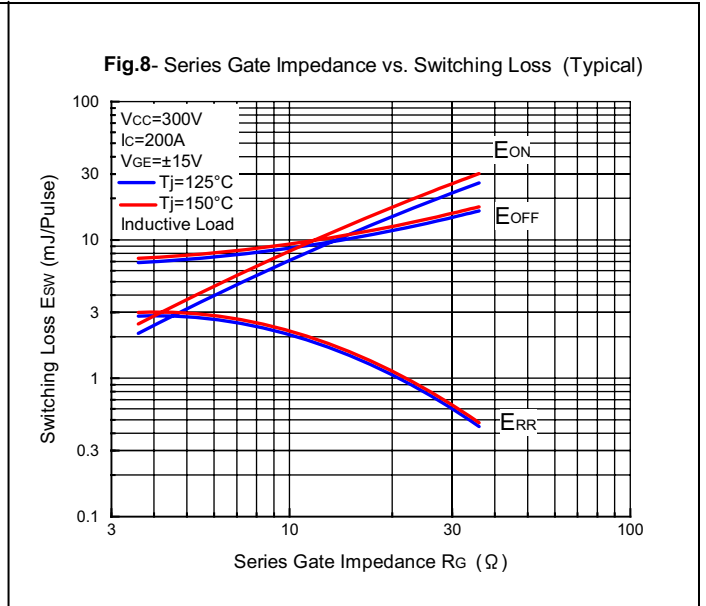
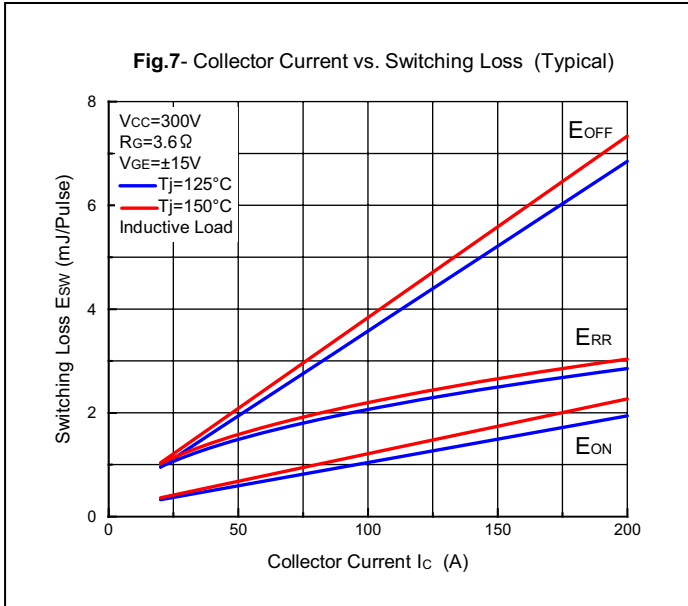

## X-ON Electronics

Largest Supplier of Electrical and Electronic Components

*Click to view similar products for [IGBT Modules category](#):*

*Click to view products by [Kyocera AVX manufacturer](#):*

Other Similar products are found below :

[F3L400R07ME4\\_B22](#) [F3L400R12PT4\\_B26](#) [FB20R06W1E3\\_B11](#) [FD300R12KE3](#) [FD300R12KS4\\_B5](#) [FD400R12KE3](#) [FF100R12KS4](#)  
[FF150R12KE3G](#) [FF200R06KE3](#) [FF200R06YE3](#) [FF300R06KE3\\_B2](#) [FF600R12IP4V](#) [FF800R17KP4\\_B2](#) [FF900R12IE4V](#)  
[FP06R12W1T4\\_B3](#) [FP100R07N3E4](#) [FP100R07N3E4\\_B11](#) [FP10R06W1E3\\_B11](#) [FP10R12W1T4\\_B11](#) [FP10R12YT3](#) [FP15R12W2T4](#)  
[FP15R12YT3](#) [FP20R06W1E3](#) [FP30R06W1E3](#) [FP40R12KT3G](#) [FP75R06KE3](#) [FS10R12YE3](#) [FS150R07PE4](#) [FS150R12PT4](#)  
[FS150R17N3E4\\_B11](#) [FS20R06W1E3\\_B11](#) [FS30R06W1E3\\_B11](#) [FS75R12KE3G](#) [FS75R12W2T4\\_B11](#) [FZ1600R17HP4\\_B2](#)  
[FZ300R12KE3G](#) [FZ400R17KE3](#) [FZ400R17KE4](#) [FZ600R65KE3](#) [DF1000R17IE4D\\_B2](#) [APTGT75DA60T1G](#) [DZ800S17K3](#) [F12-](#)  
[25R12KT4G](#) [F3L200R12W2H3\\_B11](#) [F3L300R12ME4\\_B22](#) [F3L75R07W2E3\\_B11](#) [F4-150R12KS4](#) [F475R07W1H3B11ABOMA1](#)  
[FD1400R12IP4D](#) [FD400R12KE3\\_B5](#)