

# 16V SCM Series

## Series-Connected SuperCapacitor Modules



This new series of electrochemical, double-layer, series-connected SuperCapacitor modules offers excellent pulse power handling characteristics based on the combination of very high capacitance and very low ESR. Used by themselves or in conjunction with primary or secondary batteries, they provide extended back up time, longer battery life, and provide instantaneous power pulses as needed. Offers great solutions to Hold Up, Energy Harvesting, and Pulse Power Applications.

### FEATURES

- Low ESR provides high efficiency and high power density
- Withstands high vibrations and high current applications
- Life time capable of millions of cycles
- Active cell balancing

### APPLICATIONS

- Heavy industrial equipment
- Grid storage
- UPS/Industrial systems
- Regenerative energy capture
- Pitch control

### HOW TO ORDER

<b>SCM</b>	<b>Z</b>	<b>1E</b>	<b>K</b>	<b>507</b>	<b>S</b>	<b>R</b>	<b>B</b>	<b>B</b>	<b>0</b>
Series SuperCap Module	Width Z = 68mm	Length 1E = 418mm	Voltage Code K = 16V	Capacitance Code 507 = 500F	Tolerance S = +30% / -10%	Lead Format R = Battery Posts	Package B = Bulk	Balancing B = Active Balanced	Mounting 0 = Vertical

### QUALITY INSPECTION

Parts are tested for life cycle, high temperature load life, temperature characteristics, vibration resistance, and humidity characteristics. See page 2 for more information.

### TERMINATION

Power terminals are M8 (+) and M10 (-). Recommended torque is 20 Nm (M8) and 30 Nm (M10). See pages 4 and 6 for more information on pin out and polarity.

### OPERATING TEMPERATURE

-40°C to +65°C @ 16V



For RoHS compliant products,  
please select correct termination style

# 16V SCM Series

## Series-Connected SuperCapacitor Modules



### RATINGS & PART NUMBER REFERENCES

AVX Part Number	Length (mm)	Width (mm)	Height (mm)	Capacitance (F)	Capacitance Tolerance	Rated Voltage (V)	Rated Temperature (°C)	DCL Max @ 72 Hrs (uA)	ESR Max @ 1000 Hz (mΩ)	ESR Max @ DC (mΩ)	Peak Current (A)	Power Density (W/kg)	Max Energy (Wh)	Energy Density (Wh/kg)
<b>Battery Posts</b>														
SCMZ1EK507SRBB0	418	68	179	500	+30% / -10%	16	65	60	1.8	≤ 2.1	1900	5541	17.8	3.23

### QUALIFICATION TEST SUMMARY

Test	Test Method	Parameter	Limits
Life Cycle	Capacitors are cycled between rated voltage and half-rated voltage under constant current at +25°C for 500,000 cycles	Capacitance ESR Appearance	≤30% of spec value ≤200% of spec value No remarkable defects
High Temperature Load Life	Temperature: +65°C Voltage: Rated Voltage Test Duration: 1,000 hours	Capacitance ESR Appearance	≤30% of spec value ≤200% of spec value No remarkable defects
Storage Temperature Characteristics	Storage Duration: 2 years No Load Temperature: +35°C	Capacitance ESR Appearance	≤30% of spec value ≤200% of spec value No remarkable defects
Vibration Resistance	Amplitude: 1.5mm Frequency: 10 ~ 55Hz Direction: X, Y, Z for 2 hours each	Capacitance ESR Appearance	≤30% of spec value ≤200% of spec value No remarkable defects
Humidity	Voltage: Rated Voltage RH: 90% Temperature: +60°C Test Duration: 1,000 hours	Capacitance ESR Appearance	≤30% of spec value ≤200% of spec value No remarkable defects

# 16V SCM Series

## Series-Connected SuperCapacitor Modules



### QUALITY AND RELIABILITY

CAPACITANCE VS. TEMPERATURE

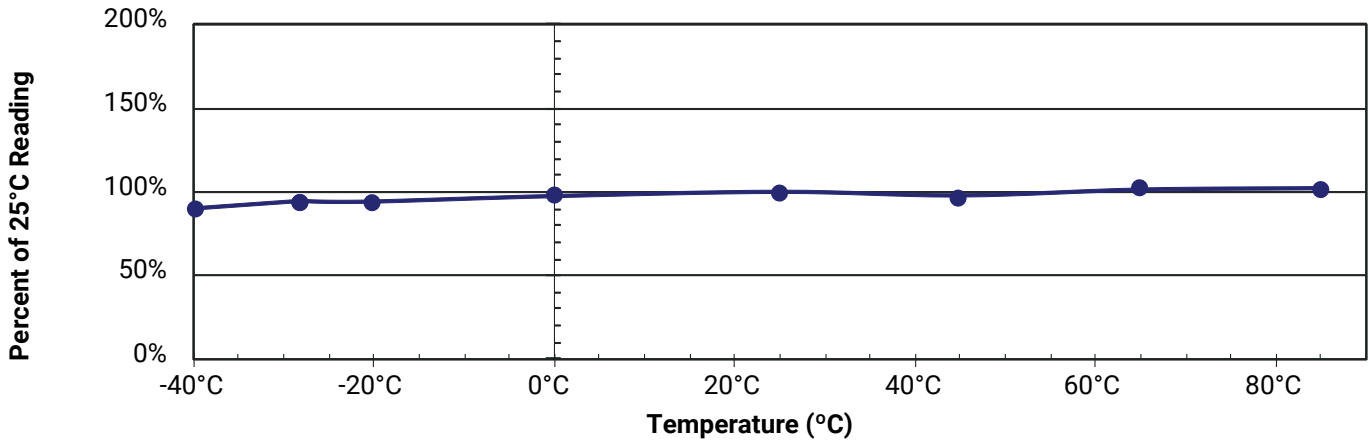

LEAKAGE CURRENT VS. TEMPERATURE

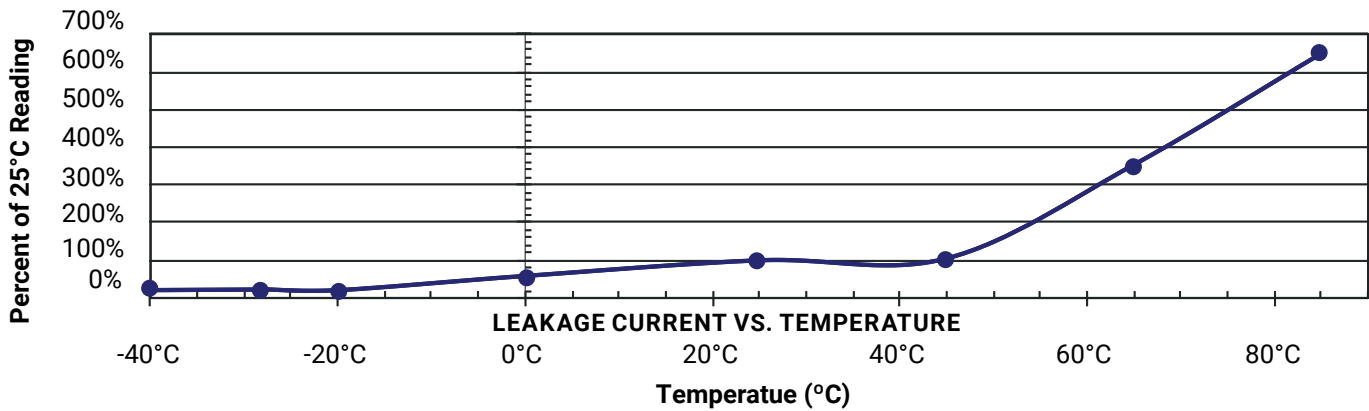

EQUIVALENT SERIES RESISTANCE VS. TEMPERATURE

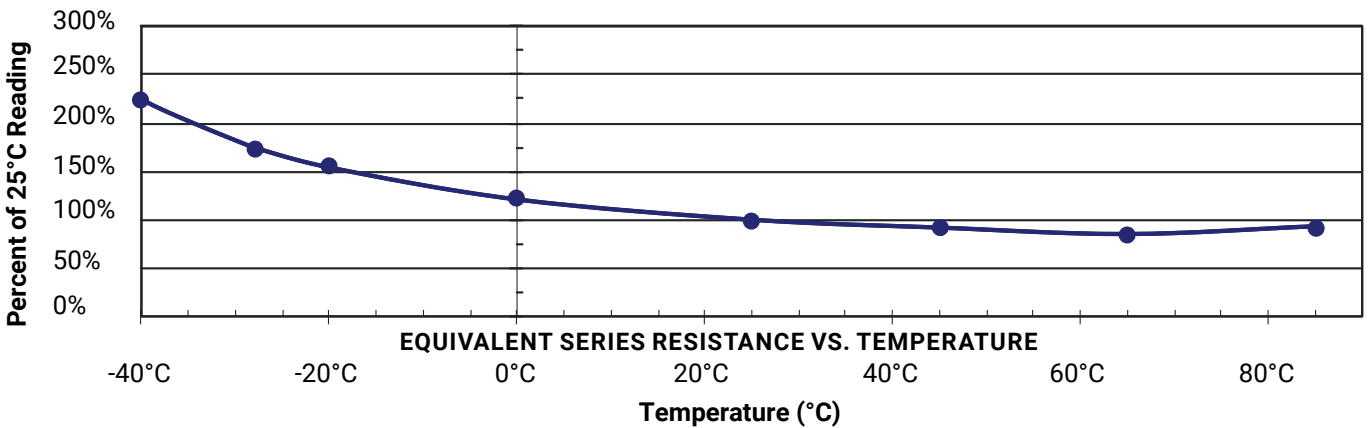

# 16V SCM Series

## Series-Connected SuperCapacitor Modules

### MECHANICAL SPECIFICATIONS

Top (All dimensions in mm)

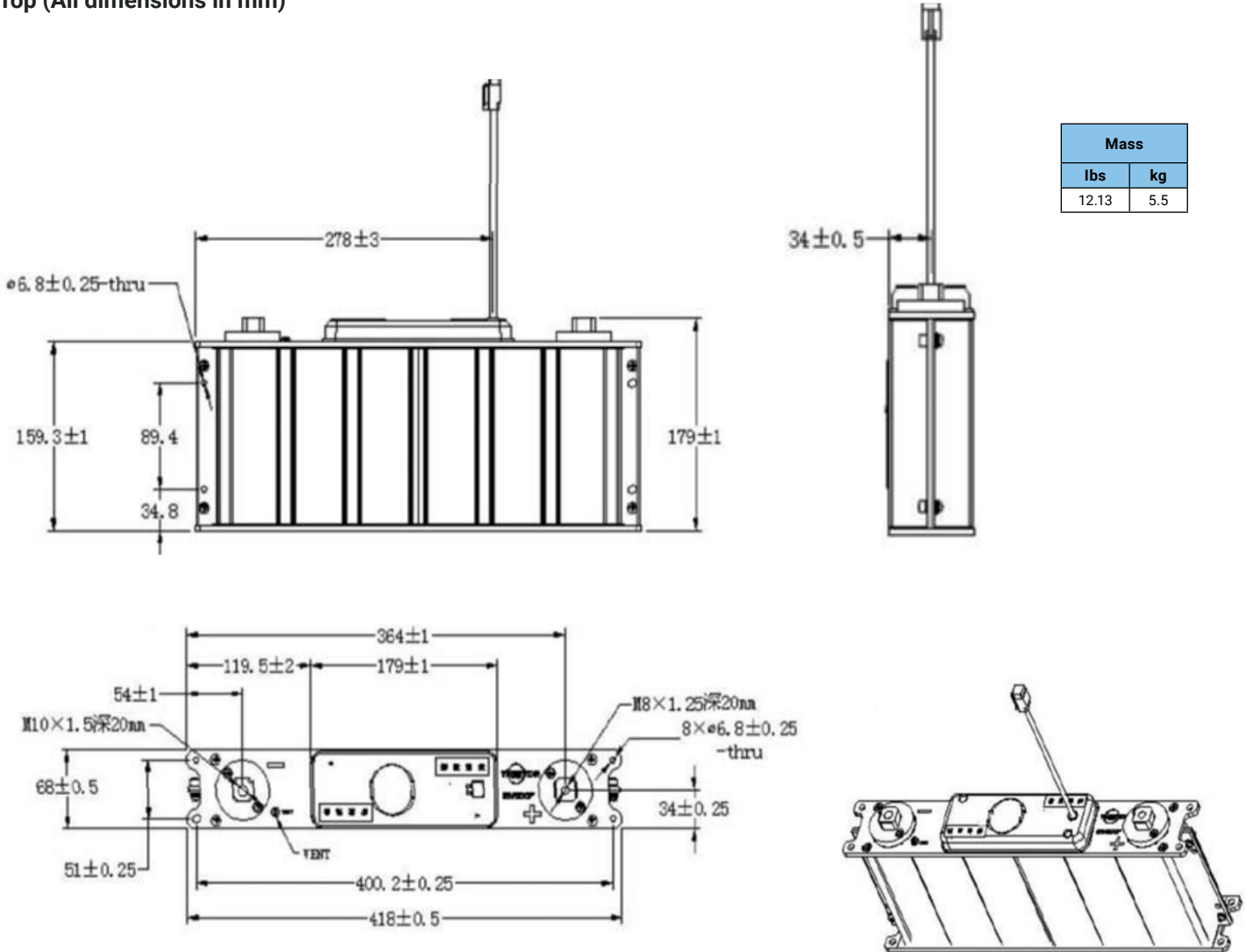

### Pin Out Designation

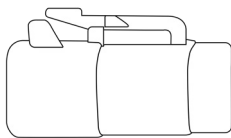

**Note:** Pin 2, the overvoltage signal, is an open collector transistor that pulls the pin low if any cell experiences an overvoltage condition. Pin 4, the temperature signal, has a 10K NTC device connected between it and the ground pin. The module temperature can be determined by reading the resistance of the NTC. See table below for resistance values at select intermediate temperatures.

Pin	Color	Designation
1	Yellow	Ground
2	Blue	Overvoltage
3	Brown	Not used
4	White	Temperature

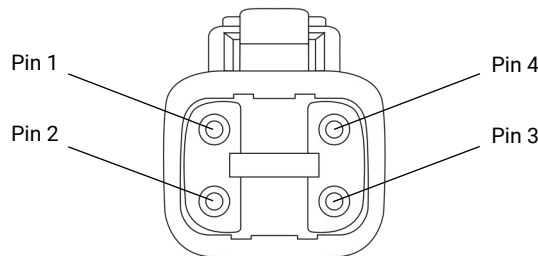

Temp (°C)	RT (Ω)
-40	332094
-25	129287
0	32554
25	10000
45	4372
65	2084
85	1070
100	677.3
125	338.7
150	182.6

### TEST METHODS

#### IEC CAPACITANCE TEST METHOD

Procedure: Charge module under constant current to rated voltage at room temperature, then hold 10 minutes on charge under constant voltage. After 10 minutes, discharge under constant current (as shown in chart below), recording voltage at  $V_1$ ,  $V_2$ , and time intervals at  $t_1$  and  $t_2$ . Use the capacitance formula to determine cap value.

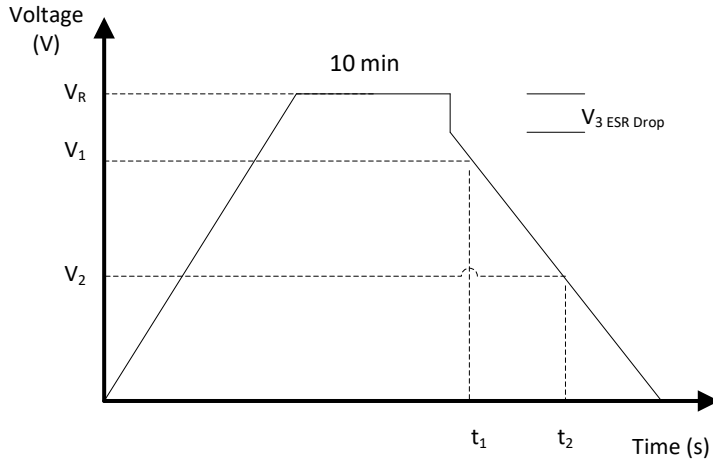

$I$  – Discharge Current,  $4 \times C \times V_R$  (mA)

$V_R$  – Rated Voltage (V)

$V_1$  – Initial Test Voltage, 80% Of  $V_R$  (V)

$V_2$  – Final Test Voltage, 40% Of  $V_R$  (V)

$t_1$  – Initial Test Time (s)

$t_2$  – Final Test Time (s)

$$C = \frac{I \times (t_2 - t_1)}{V_1 - V_2}$$

#### DC ESR MEASUREMENT

A six-step ESR<sub>DC</sub> test method is illustrated to the right and carried out as follows:

- Rest 10 Seconds
- Charge under constant current ( $I_1$ ) to rated voltage ( $V_R$ )
- Rest 5 seconds
- Rest 10 seconds, record  $V_3$  and  $t_4$
- Discharge under constant current ( $I_2$ ) to half rated voltage, Record  $I_2$ ,  $V_4$ , And  $t_5$
- Rest 5 seconds, record  $V_5$  And  $t_6$

Repeat steps 1-6 recording  $I$ ,  $V$ , And  $t$  accordingly, finally discharging to below 0.1V under constant current ( $I_2$ ).

Formulas to calculate:

• Two cycle discharge capacitances:  $C_{dch1} = I_2 \times \frac{(t_5 - t_4)}{V_3 - V_4}$ ;  $C_{dch2} = I_2 \times \frac{(t_{11} - t_{10})}{(V_9 - V_{10})}$

• Discharge capacitance:  $C_{dch} = \frac{(C_{dch1} + C_{dch2})}{2}$

• Two cycle discharge DC ESR:  $ESR_{dch1} = \frac{(V_5 - V_4)}{I_2}$ ;  $ESR_{dch2} = \frac{(V_{11} - V_{10})}{I_2}$

• Discharge DC ESR:  $ESR_{dch} = \frac{(ESR_{dch1} + ESR_{dch2})}{2}$

Note:  $I_1 = I_2 = 75mA/F$ , the rated capacitance in the chart means discharge capacitance, and DC ESR ( $ESR_{DC}$ ) means discharge DC resistance.

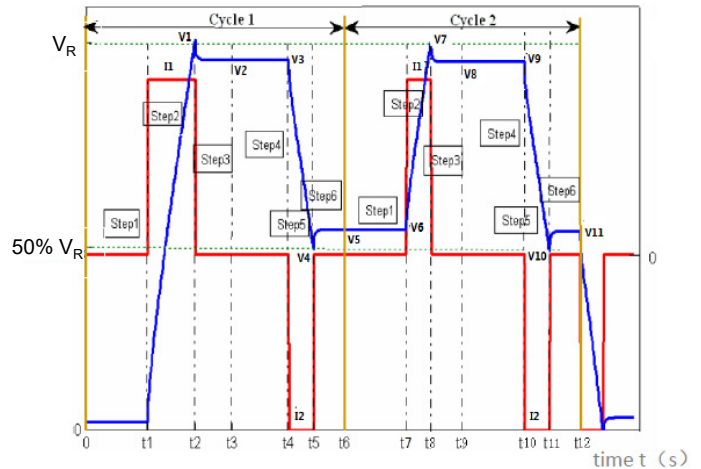

# 16V SCM Series

## Series-Connected SuperCapacitor Modules



### TEST METHODS (continued)

#### MAXIMUM CONTINUOUS CURRENT

- This is the maximum current when temperature rise of the supercapacitor during its operation is less than 15°C

#### MAXIMUM PEAK CURRENT

- This is the maximum current during 1 second time interval (dt)

#### WATT DENSITY

- Watt Density =  $(0.12 \cdot V^2 / R_{DC}) / \text{mass}$

#### ENERGY DENSITY

- Energy Density =  $(\frac{1}{2} CV^2) / (3600 \cdot \text{mass})$

### POLARITY AND REVERSE VOLTAGE

For product consistency and optimum performance, it is recommended that the capacitor be connected with polarity indicated. Reversing polarity could result in permanent damage to the circuit including much higher leakage current for a short duration of time and the life time of the supercapacitors will be reduced.

### LIFE TIME AND TEMPERATURE PERFORMANCE

The life of a supercapacitor is impacted by a combination of operating voltage and the operating temperature according to the following Time to Failure equation:

$$t \propto V^n \times e^{\left(\frac{-Q}{kT}\right)}$$

where V is the operating voltage, Q is the activation energy in electron volts (eV), k is the Boltzmann constant in eV, and T is the operating temperature in Kelvin (K). Typical values for the voltage exponent, n, is between 2.5-3.5, and Q is between 1.0-1.2 eV in the normal operating temperature range of -40° to 65°C.

The industry standard for supercapacitor end of life is when the equivalent series resistance, ESR, increases to 200% of the specified value and the capacitance drops by 30% from specified value. Typically a supercapacitor shows an initial “jump” in the ESR value and then levels off. If the supercapacitors are exposed to excessive temperatures the ESR will show a continuous degradation (increase). In the extreme case, if the temperature or voltage are substantially higher than the rated specifications, this could result in the part venting and the product showing a faster degradation of capacitance and ESR, which may be many times the specified value.

# 16V SCM Series

## Series-Connected SuperCapacitor Modules



Expected Lifetime at Various Voltages  
SCM Series

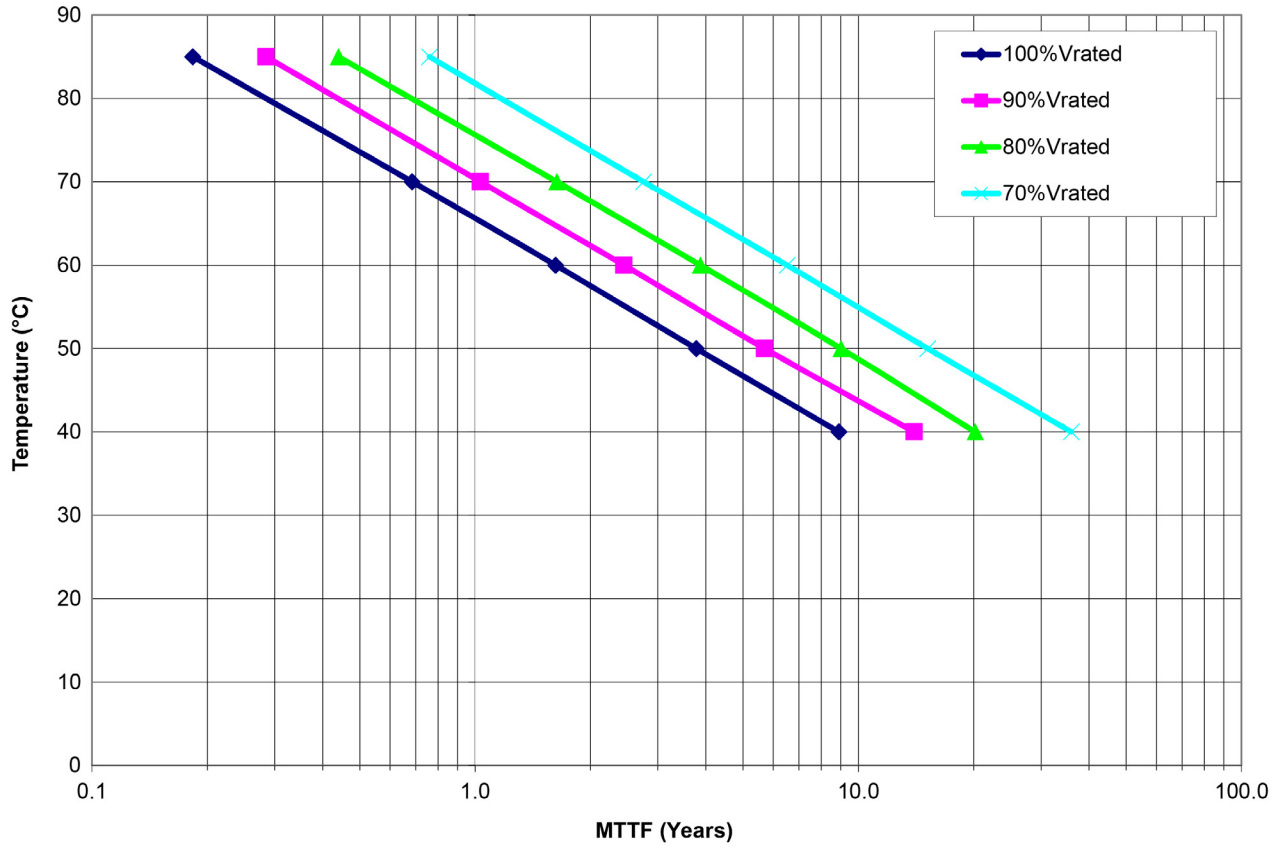

# 16V SCM Series

## Series-Connected SuperCapacitor Modules



### SAFETY RECOMMENDATIONS

#### WARNINGS

- To Avoid Short Circuit, after usage or test, Super Capacitor voltage needs to discharge to  $\leq 0.1V$
- Do not Apply Overvoltage, Reverse Charge, Burn or Heat Higher than  $150^{\circ}C$ , explosion-proof valve may break open
- Do not Press, Damage or disassemble the Super Capacitor, housing could heat to high temperature causing Burns
- If you observe Overheating or Burning Smell from the capacitor disconnect Power immediately, and do not touch

#### EMERGENCY APPLICATIONS

- If Housing is Leaking:
- Skin Contact: Use soap and water thoroughly to wash the area of the skin
- Eye Contact: Flush with flowing water or saline, and immediately seek medical treatment
- Ingestion: Immediately wash with water and seek medical treatment

#### TRANSPORTATION

Not subjected to US DOT or IATA regulations  
UN3499, <10Wh, Non-Hazardous Goods  
International shipping description –  
“Electronic Products – Capacitor”

Licensed by CAP-XX

#### REGULATORY

- UL 810A
- RoHS Compliant
- REACH Compliant

#### STORAGE

Capacitors may be stored within the temperature range of  $-40^{\circ}C$  to  $+70^{\circ}C$  with humidity  $< 60\%$ . Lower storage temperature is preferred as it extends the shelf life of the capacitor. Product over one year and within two years of the date code, we recommend recharging the product at the beginning of use for at least 24 hours.

Optimum storage conditions are as follows:

- $25^{\circ}C$  and  $RH \leq 60\%$  without voltage applied
- Not in direct sunlight
- Not in direct contact with water, salt oil or other chemicals
- Not in direct contact with corrosive materials, acids, alkalis, or toxic gases
- Not in dusty environments
- Not in environments with shock and vibration conditions



## X-ON Electronics

Largest Supplier of Electrical and Electronic Components

*Click to view similar products for [Supercapacitors](#) / [Ultracapacitors](#) category:*

*Click to view products by [Kyocera AVX](#) manufacturer:*

Other Similar products are found below :

[C-TEC1225 P](#) [SCCY73B407SLBLE](#) [CDCL3000C0-002R85STB](#) [MDCM0058C0-0016R0TBZ](#) [FE0H473ZF](#) [MAL223551012E3](#)  
[MAL223551014E3](#) [MAL223551015E3](#) [MAL223551016E3](#) [MAL223551007E3](#) [MAL223551001E3](#) [MAL223551008E3](#) [MAL219612474E3](#)  
[MAL219632473E3](#) [DRE10/2.5](#) [DRL106S0TI25RRDAP](#) [DRL226S0TK25RR](#) [106DCN2R7M](#) [SCCT30B156SRB](#) [SCMR14C474MSBA0](#)  
[SCMR22C155MSBA0](#) [DRL475S0TG20RRDAP](#) [GW209F](#) [TV1020-3R0605-R](#) [SCCX50B207VSB](#) [PAS0815LS2R5105](#) [HVZ0E475NF](#)  
[SCMR18F105PSBA0](#) [FT0H565ZF](#) [FE0H224ZF](#) [SCCT30E156SRB](#) [MAL222090006E3](#) [SCCY68B407SSBLE](#) [CPH3225A-2K](#)  
[SCMT22C505PRBA0](#) [207DCN2R7M](#) [DB5U307W35050HA](#) [DB5U407W35060HA](#) [DGH505Q5R5](#) [DGH305Q2R7](#) [DGH505Q2R7](#)  
[DGH705Q2R7](#) [DGH506Q2R7](#) [DGH504Q5R5](#) [DGH335Q2R7](#) [DGH256Q2R7](#) [DGH255Q5R5](#) [DGH207Q2R7](#) [DGH155Q5R5](#) [DGH107Q2R7](#)