

Tantalum Series Guide

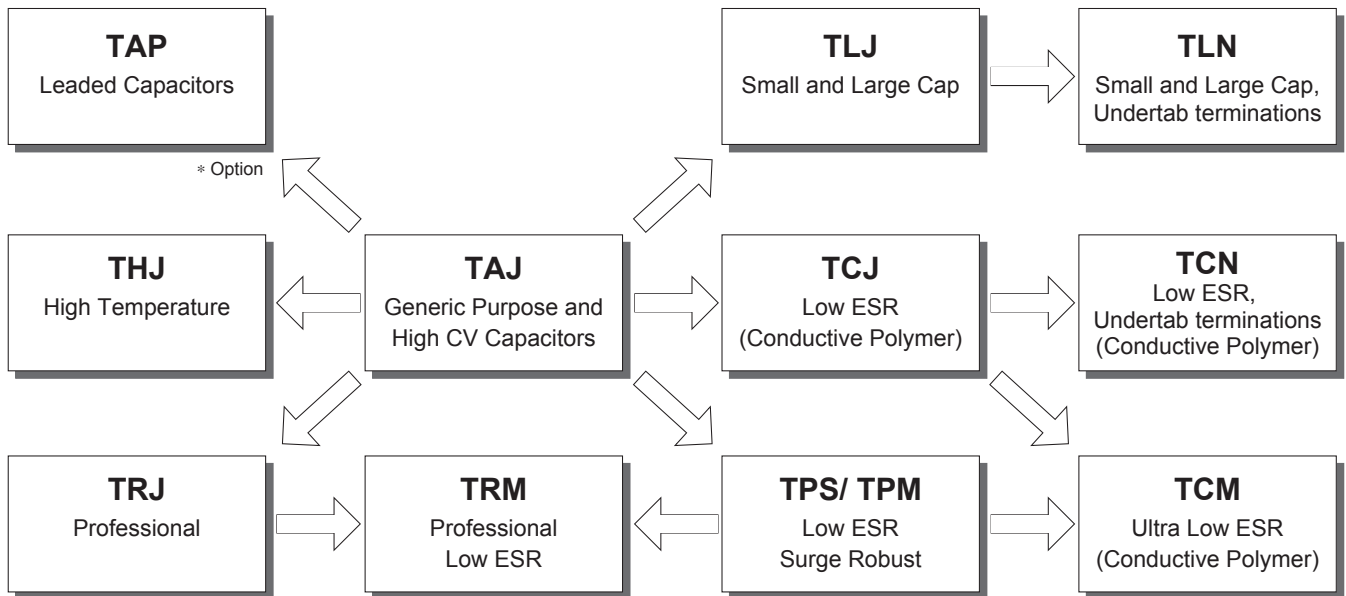

Niobium Oxide Series Guide

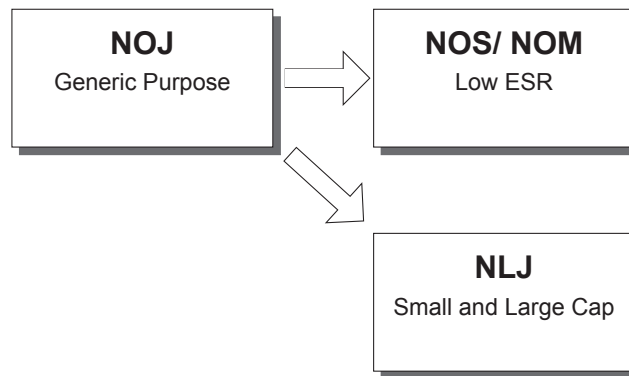

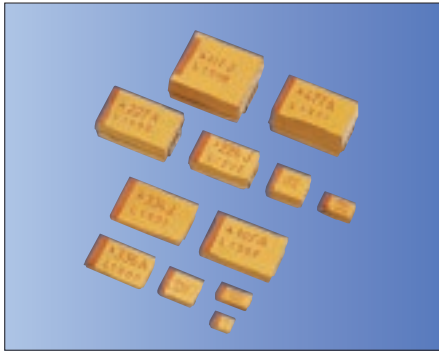

RoHS Compliant

Features

- 50V type is available
- 2200µF/ 2.5V (V case) is available
- 25mΩESR type is available
50 for TPS series

Applications

- Electronic Equipment in General
- CPU's
- Power Supply Circuit

How to Order

TAJ B 107 M 010 Y NJV
 ① ② ③ ④ ⑤ ⑥ ⑧

TPS B 107 M 010 Y 0400 V
 ① ② ③ ④ ⑤ ⑥ ⑦ ⑧

TPM E 108 M 004 R 0018
 ① ② ③ ④ ⑤ ⑥ ⑦

- ① Series
- ② Case Size (See Table)
- ③ Capacitance (pF)
(Code: 2 Significant Digits and Number of Zeros)
- ④ Tolerance

K	±10%	M	±20%
----------	------	----------	------

- ⑤ Rated DC Voltage

ex.	006	6.3VDC	
002	2.5VDC	016	16VDC

- ⑥ Packaging

TAJ/ TPS Series

Y	Plastic Tape (7" Reel)
----------	------------------------

TPM Series

R	Plastic Tape (7" Reel)
----------	------------------------

- ⑦ ESR

ex.	0100	100mΩ
------------	-------------	-------

- ⑧ Dry pack

NJV	TAJ Series
V	TPS Series

Case Dimensions

(Unit: mm)

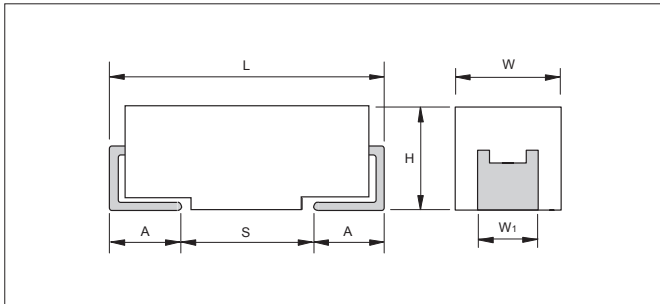

Case size	L	W	H	W ₁	A	S min.
A	3.2±0.2	1.6 ^{+0.2} _{-0.1}	1.6 ^{+0.2} _{-0.1}	1.2±0.2	0.8 ^{+0.3} _{-0.2}	1.1
B	3.5±0.2	2.8 ^{+0.2} _{-0.1}	1.9 ^{+0.2} _{-0.1}	2.2±0.2	0.8 ^{+0.3} _{-0.2}	1.4
C	6.0±0.2	3.2 ^{+0.2} _{-0.1}	2.6 ^{+0.2} _{-0.1}	2.2±0.2	1.3 ^{+0.3} _{-0.2}	2.9
D	7.3±0.2	4.3 ^{+0.2} _{-0.1}	2.9 ^{+0.2} _{-0.1}	2.4±0.2	1.3 ^{+0.3} _{-0.2}	4.4
E	7.3±0.2	4.3 ^{+0.2} _{-0.1}	4.1 ^{+0.2} _{-0.1}	2.4±0.2	1.3 ^{+0.3} _{-0.2}	4.4
U	7.3±0.2	6.1 ^{+0.2} _{-0.1}	4.1 ^{+0.2} _{-0.1}	3.1±0.2	1.3 ^{+0.3} _{-0.2}	4.4
V	7.3±0.2	6.1 ^{+0.2} _{-0.1}	3.45±0.3	3.1±0.2	1.3 ^{+0.3} _{-0.2}	4.4
F	6.0±0.2	3.2 ^{+0.2} _{-0.1}	2.0 max.	2.2±0.2	1.3 ^{+0.3} _{-0.2}	2.9
H	3.5±0.2	2.8 ^{+0.2} _{-0.1}	1.5 max.	2.2±0.2	0.8 ^{+0.3} _{-0.2}	1.4
K	3.2±0.2	1.6 ^{+0.2} _{-0.1}	1.0 max.	1.2±0.2	0.8 ^{+0.3} _{-0.2}	1.1
P	2.05±0.2	1.35 ^{+0.2} _{-0.1}	1.5 max.	1.0±0.2	0.5 ^{+0.3} _{-0.2}	0.85
R	2.05±0.2	1.3 ^{+0.2} _{-0.1}	1.2 max.	1.0±0.2	0.5 ^{+0.3} _{-0.2}	0.85
S	3.2±0.2	1.6 ^{+0.2} _{-0.1}	1.2 max.	1.2±0.2	0.8 ^{+0.3} _{-0.2}	1.1
T	3.5±0.2	2.8 ^{+0.2} _{-0.1}	1.2 max.	2.2±0.2	0.8 ^{+0.3} _{-0.2}	1.4
W	6.0±0.2	3.2 ^{+0.2} _{-0.1}	1.5 max.	2.2±0.2	1.3 ^{+0.3} _{-0.2}	2.9
X	7.3±0.2	4.3 ^{+0.2} _{-0.1}	1.5 max.	2.4±0.2	1.3 ^{+0.3} _{-0.2}	4.4
Y	7.3±0.2	4.3 ^{+0.2} _{-0.1}	2.0 max.	2.4±0.2	1.3 ^{+0.3} _{-0.2}	4.4

Specifications

Rated Voltage Code	002	004	006	010	016	020	025	035	050
Rated Voltage (V _R) + 85°C	2.5	4	6.3	10	16	20	25	35	50
Category Voltage (V _C) +125°C	1.7	2.7	4	7	10	13	17	23	33
Surge Voltage (V _S) + 85°C	3.3	5.2	8	13	20	26	32	46	65
+125°C	2.2	3.4	5	8	13	16	20	28	40
Operating Temperature Range	-55°C to +125°C								
Failure Rate	1%/ 1000H (85°C, Rated Voltage, 0.1Ω/ V), 60% confidence level								

Capacitance and Voltage Range

Capacitance		Capacitance Range (letter denotes case code)								
		Rated Voltage								
μF	CODE	2.5V	4V	6.3V	10V	16V	20V	25V	35V	50V
0.10	104								A	A
0.15	154								A	A/B
0.22	224								A	A/B
0.33	334								A	A/B
0.47	474							A	A/B	A/B/C
0.68	684							A	A/B	A/B/C
1.0	105						A	A	A/B	A/B/C
1.5	155						A	A/B	A/B/C	B/C/D
2.2	225					A	A/B	A/B	A/B/C	B/C/D
3.3	335					A/B	A/B	A/B	B/C	C/D
4.7	475				A	A/B	A/B	A/B	B/C/D	C/D
6.8	685				A	A/B	A/B/C	B/C	C/D	C/D
10	106			A	A	A/B/C	B/C	B/C/D	C/D/E	D/E/V
15	156			A	A/B	A/B/C	B/C	C/D	C/D	C/D
22	226			A	A/B	B/C/D	B/C/D	C/D	D/E	D/E/V
33	336	A	A	A	A/B/C	B/C/D	C/D	D/E	D/E/V	
47	476	A	A	A/B/C	B/C	C/D	C/D/E	D/E	E/V	
68	686	A	A/B	B/C	B/C	C/D	C/D/E	E/V	V	
100	107	A/B	A/B	B/C	B/C/D	C/D/E	D/E/V	E/V		
150	157	B	B/C	B/C/D	C/D/E	D/E/V	E/V	<u>V</u>		
220	227	B/D	B/C/D	C/D/E	C/D/E	E/V				
330	337	D	C/D	C/D/E	D/E/V	E				
470	477	C/D	C/D/E	D/E/V	E/U/V					
680	687	C/D/E	D/E	E/V						
1000	108	D/E	D/E/V	E/V						
1500	158	D/E/ <u>V</u>	E/ <u>V</u>							
2200	228	<u>V</u>								

Note: Voltage ratings are minimum values. AVX reserves the right to supply higher voltage ratings in the same case size, to the same reliability standards.
Only M tolerance available for underlined parts.

Capacitance and Voltage Range (Low Profile)

Capacitance		Capacitance Range (letter denotes case code)								
		Rated Voltage								
μF	CODE	2.5V	4V	6.3V	10V	16V	20V	25V	35V	50V
0.10	104						R/S		R/S	S
0.15	154						R/S	R	R/S	S
0.22	224						R/S	R	R/S	P/R/S
0.33	334						R/S	R	R/S	P/R/S/T
0.47	474						R/S	R/S	R/S/T	S/T
0.68	684					R/S	R/S/T	R/S	P/S/T	
1.0	105				R/S	R/S/T	R/S/T	P/R/S	P/S/T	W
1.5	155			R/S	R/S	R/S	P/R/S/T	P/S/T	T	W
2.2	225		R/S	R/S	R/S	R/S/T	P/R/S/T	T	T	
3.3	335		R/S	R/S	R/S/T	R/S/T	T	T/W	W	Y
4.7	475	R	R/S	R/S/T	R/S/T	K/P/S/T	T	T/W	W	Y
6.8	685	R	R/S/T	R/S/T	P/R/S/T	S/T	T	W	Y	Y
10	106	R/S	R/S/T	P/R/S/T	K/P/B/S/T	T/W	W	W	X/Y	
15	156	R	R/S/T	K/P/R/S/T	S/T/W	I/W	W	Y	Y	
22	226	P/R	K/P/R/S/T	K/P/S/T/W	T/W	W	W/Y	Y	Y	
33	336	K/P/S	K/P/S/T/W	T/W	W	W/Y	X/Y	Y		
47	476	P/S	T/W	T/W	H/W/Y	W/X/Y	X/Y	Y		
68	686	T	T/W	W	W/Y	F/X/Y	Y			
100	107	T/W	I/W	W/Y	W/X/Y	F/Y				
150	157	I/W	W/Y	W/X/Y	F/X/Y	<u>Y</u>				
220	227	W/Y	W/X/Y	F/X/Y	Y					
330	337	W/Y	F/X/Y	Y						
470	477	F/Y	Y	Y						
680	687	Y	<u>Y</u>							
1000	108	<u>Y</u>								

Note: Voltage ratings are minimum values. AVX reserves the right to supply higher voltage ratings in the same case size, to the same reliability standards.
Only M tolerance available for underlined parts.

Capacitance and Voltage Range (ESR)

Capacitance		Capacitance Range (letter denotes case code.ESR in parentheses.)								
		Rated Voltage								
μF	CODE	2.5V	4V	6.3V	10V	16V	20V	25V	35V	50V
0.15	154									A (9000)
0.22	224								A (6000)	A (7000)
0.33	334								A (6000)	A (7000)
0.47	474							A (7000)	A (6000) B (4000)	A (6500) B (6000) C (2300)
0.68	684							A (6000)	A (6000)	B (4000)
1.0	105				R (9000)		A (3000) R (6000) S (6000) T (2000)	A (4000) R (2500, 4000)	A (3000) B (2000)	B (3000) C (2500)
1.5	155						A (3000)	A (3000)/ B (1800)	A (3000)/ B (2500)	C (1500, 2000)
2.2	225			R (7000)	A (1800)	A (1800, 3500) T (2000)	A (3000) B (1700)	A (2500) B (900, 1200, 2500)	A (1500) B (750, 1500, 2000) C (1000)	C (1500) D (1200)
3.3	335				T (1500)	A (3500) B (2500)	A (2500) B (1300)	A (1000, 1500) B (750, 1500, 2000) C (700)	B (1000) C (700)	C (1000) D (800)
4.7	475			S (4000)	A (1400) R (3000, 5000)	A (2000)	A (1800)	B (700, 900, 1500) C (700)	B (700, 1500) C (600)/ D (700)	C (800) D (300, 500, 700)
6.8	685			A (1800)	A (1800) T (1800)	A (1500) B (600, 1200)	A (1000) B (600, 1000) C (700)	B (700) C (500, 600, 700)	C (350) D (150, 400, 500)	D (200, 300, 500, 600)
10	106		R (3000)	A (1500) R (1000, 1500, 3000) T (1000)	A (900, 1800) B (1000) P (2000) S (900) T (1000, 2000)	A (1000) B (500, 800) C (500) T (800, 1000) W (500, 600)	B (500, 1000) C (500, 700) W (250, 500)	C (300, 500) D (500)	C (600) D (125, 300) E (200) Y (250)	D (500) E (250, 300, 400, 500) D (140) E (120)
15	156			A (700, 1500)	A (1000) B (450, 600) T (1200)	B (500, 800) C (700)	B (500) C (400, 450)	C (220, 300) D (100, 300)	C (350, 450) D (100, 300) Y (250)	E (250)/ V (250) E (75, 100)
22	226			A (500, 900) B (375, 600) S (900)	A (900) B (400, 500, 700) C (300)/ T (800)	B (400, 600) C (150, 250, 300, 375) W (500)	B (400, 600) C (100, 150, 400) D (200, 300)	C (275, 400) D (100, 200, 300)	D (125, 200, 300, 400) E (125, 200, 300) Y (200) D (70) E (60, 100)	E (75, 100)
33	336			A (600) B (250, 350, 450, 600) T (800)	A (700) B (250, 425, 500, 650) C (150, 375, 500) W (350)	B (350, 500) C (100, 150, 225, 300) D (200) W (140, 175, 250, 400, 500) Y (300, 400)	C (300) D (100, 200)	D (100, 200, 300) E (100, 175, 200, 300) Y (200) D (65)	D (200, 300) E (100, 250, 300) V (200) E (50, 65)	
47	476		A (500)	A (800) B (250, 350, 500) C (300) T (1200)	B (250, 350, 500, 650) C (200, 350) D (100) W (125, 150, 250)	C (125, 200) D (70, 100, 150) F (200) X (150) Y (150, 200, 250) D (40, 50)	D (75, 100, 200) E (70, 125, 150, 200, 250) X (180) Y (250)	D (125, 150, 250) E (80, 100, 125) V (150, 200) E (55, 65)	E (200, 250) V (150, 200) E (55, 65)	
68	686			B (250, 350, 500) C (150, 200) W (110, 125, 250)	B (600) C (80, 100, 200, 300) D (100, 150) W (100, 150) Y (100, 200)	C (125, 200) D (70, 100, 150) F (200) X (150) Y (150, 200, 250) D (40, 50)	D (70, 150, 200, 300) E (125, 150, 200)	E (125, 200) V (80, 95, 150, 200) E (45, 55)	V (150, 200)	
100	107	B (200)	B (200, 250, 350, 500) W (100)	B (250, 400) C (75, 150) D (300) W (100, 150) Y (100)	B (400) C (75, 100, 150, 200) D (50, 65, 80, 100, 125, 150) E (125)/ W (150) X (85, 150, 200) Y (100, 150, 200) Y (45) C (150) D (50, 85, 100) E (100)/ F (200) X (100) Y (100, 150, 200) Y (45)	C (200) D (80, 100, 125, 150) E (55, 100, 125, 150) F (150, 200) Y (100, 150, 200) D (40, 50)	D (85, 100, 150) E (100, 150, 200) V (60, 85, 100, 200) E (35, 45)	<u>E (150)</u> V (100)		
150	157	B (150)	B (250) C (70, 80)	C (50, 90, 150, 200, 250) D (50, 125) Y (40, 50)	D (50, 85, 100) E (100)/ F (200) X (100) Y (100, 150, 200) Y (45)	D (60, 85, 100, 125, 150) E (100) V (45, 75) Y (200) E (30, 40)	V (80) E (35)	V (150)		
220	227	B (150, 200, 600) D (45)	D (40, 50, 100) Y (40, 50, 75)	C (70, 100, 125, 250) D (50, 100, 125) E (100) F (200) Y (100, 150) Y (30)	D (40, 50, 100, 150) E (50, 60, 70, 100, 125, 150) Y (100, 150, 200) D (35)	E (100, 150) V (50, 75, 100, 150) E (25, 40)				
330	337	Y (40)	C (100) D (35, 45, 100) F (200) X (100) D (25, 35)	C (80, 100) D (45, 50, 70, 100) E (50, 100, 125, 150) V (100) Y (100, 150) D (25, 35)	D (50, 65, 100, 150) E (40, 50, 60, 100) V (40, 60, 100) D (35) E (23, 35)	E (200)				
470	477	D (35) F (200) Y (100)	D (45, 100) E (35, 45, 100) D (25, 35)	D (45, 60, 100, 200) E (45, 50, 60, 100, 200) V (40, 55, 100) Y (150) D (30) E (18, 23, 30)	E (45, 50, 60, 100, 200) V (40, 60, 100) E (23, 30)					
680	687	D (35, 50) E (35, 50) Y (100)	D (45, 60, 100) E (40, 60, 100) D (25) E (18, 23)	E (45, 60, 100) V (35, 40, 50) E (18, 23)/ V (23)						
1000	108	E (30, 40) Y (100) D (25)	V (25, 35, 40, 50) D (25, 45) E (18, 23)/ V (18)	E (100) V (40, 50) E (25)/ V (20)						
1500	158	D (100) E (50) V (30, 40) E (12, 15, 18)	E (50, 75) V (50, 75) E (15, 18)							
2200	228	E (18)								

Note: Voltage ratings are minimum values. AVX reserves the right to supply higher voltage ratings in the same case size, to the same reliability standards.
 Shaded portion indicates TPM series products.
 Only M tolerance available for underlined parts.

Packaging

Tape and reel packaging for automatic component placement.
Please enter required suffix code, R or S on order.

• Reel

(Unit: mm)

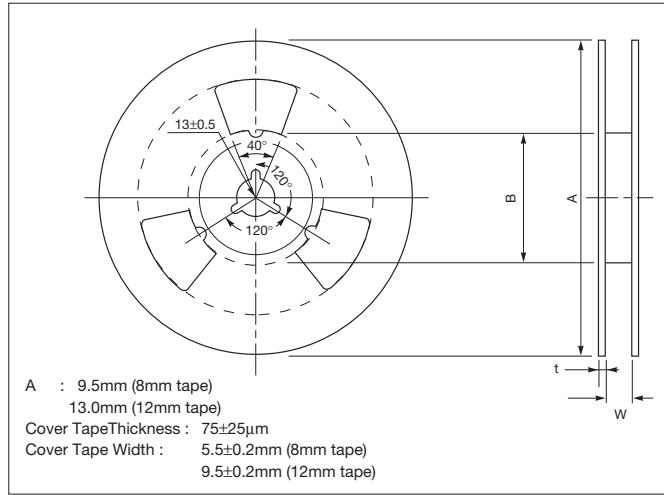

Reel Size	Tape width (mm)	A	B	C	W	t
180mm (7")	12	180±2.00	50 min.	13.0±0.50	12.4+1.5/-0	2.0±0.50
180mm (7")	8	180±2.00	50 min.	13.0±0.50	8.4+1.5/-0	2.0±0.50

• Taping

Series	Case Size	Tape Width (mm)	P (mm)	7" Reel (pcs.)
TAJ	A	8	4	2000
	B	8	4	2000
TPS	C	12	8	500
	D	12	8	500
TPM	E	12	8	400
	U	16	8	400
TCJ	V	12	8	400
	W	12	8	400
TLJ	F	12	8	1000
	G	8	4	2500
TRJ	H	8	4	2500
	K	8	4	3000
THJ	L	8	4	2500
	M	8	4	3000
TRM	N	8	4	3000
	P	8	4	2500
TLN	R	8	4	2500
	S	8	4	2500
TCN	T	8	4	2500
	W	12	8	1000
TCM	X	12	8	1000
	Y	12	8	1000
NOJ	4	16	8	800
	6	24	12	500

• Moisture Sensitive Level (MSL)

Series	MSL
TAJ TPS THJ TRJ	1 (Some of them are MSL=3)
NOJ	• For D, E, V, X and Y case sizes : 3 • For the other than the above : 1 (MSL = 3 only for Low ESR)
NOS	• For D, E, V, X and Y case sizes : 3 • For the other than the above : 1

• Carrier Tape

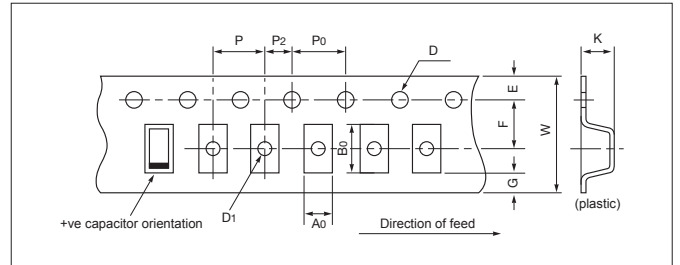

Tape dimensions comply to EIA 481 A.
Dimensions A₀ and B₀ of the pocket and the tape thickness, K, are dependent on the components size.
Tape material do not affect component solderability during storage.
Carrier tape thickness < 0.4mm
For 16mm tape and 24mm tape, please contact factory.

(Unit: mm)

Code	8mm tape	12mm tape
P	4±0.1	8±0.1
G	0.75 min.	0.75 min.
F	3.5±0.05	5.5±0.05
E	1.75±0.1	1.75±0.1
W	8±0.3	12±0.3
P ₂	2±0.05	2±0.05
P ₀	4±0.1	4±0.1
D	1.5 ^{+0.2} _{-0.0}	1.5 ^{+0.2} _{-0.0}
D ₁	1.0 min.	1.5 min.

• Carrier Tape

(Unit: mm)

Series	Case Size	A ₀	B ₀	K
TAJ	A	1.83±0.1	3.57±0.1	1.87±0.1
	B	3.15±0.1	3.77±0.1	2.22±0.1
	C	3.45±0.1	6.4±0.1	2.92±0.1
TPS	D	4.48±0.1	7.62±0.1	3.22±0.1
	E	4.5±0.1	7.5±0.1	4.5±0.1
	U	6.19±0.1	7.66±0.1	4.72±0.1
TPM	V	6.43±0.1	7.44±0.1	3.84±0.1
	W	6.43±0.1	7.44±0.1	3.84±0.1
	F	3.35±0.1	6.4±0.1	2.2±0.1
TCJ	G	1.83±0.1	3.57±0.1	1.65±0.1
	H	3.15±0.1	3.77±0.1	1.66±0.1
	K	1.95±0.1	3.55±0.1	1.15±0.1
TLJ	L	3.10±0.1	3.80±0.1	1.30±0.1
	M	1.60±0.1	2.35±0.1	1.10±0.1
	N	1.60±0.1	2.30±0.1	1.10±0.1
TRJ	P	1.65±0.1	2.45±0.1	1.6±0.1
	R	1.65±0.1	2.45±0.1	1.3±0.1
	S	1.95±0.1	3.55±0.1	1.3±0.1
THJ	T	3.2±0.1	3.8±0.1	1.3±0.1
	W	3.57±0.1	6.4±0.1	1.65±0.1
	X	4.67±0.1	7.62±0.1	1.65±0.1
TRM	Y	4.67±0.1	7.62±0.1	2.15±0.1
	4	6.25±0.1	7.88±0.1	2.25±0.1
	6	8.55±0.1	15.60±0.1	2.25±0.1

Series	MSL
TPM TCJ TLJ TRM TLN TCN TCM NOM NLJ	3

Recommended Land Pattern

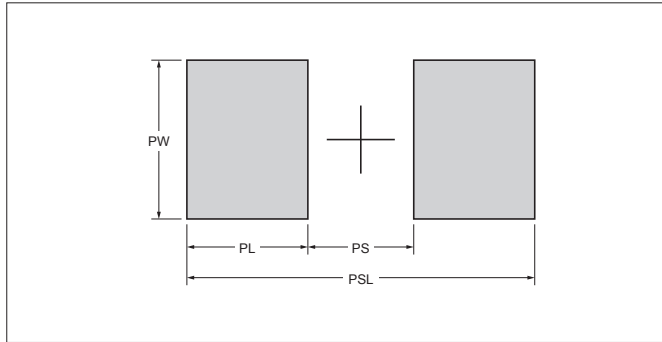

(Unit: mm)

Series	Case Size	PSL	PL	PS	PW	
TAJ	A	4.00	1.40	1.20	1.80	
	B	4.00	1.40	1.20	2.80	
	C	6.50	2.00	2.50	2.80	
	D	8.00	2.00	4.00	3.00	
	TPS	E	8.00	2.00	4.00	3.00
	TPM	U	8.00	2.00	4.00	3.70
	TCJ	V	8.00	2.00	4.00	3.70
	TLJ	F	6.50	2.00	2.50	2.80
	TRJ	G	4.00	1.40	1.20	1.80
	THJ	H	4.00	1.40	1.20	2.80
	TRM	K	4.00	1.40	1.20	1.80
	TCM	N	2.70	0.95	0.80	1.60
	NOJ	P	2.70	0.95	0.80	1.60
	NOS	R	2.70	0.95	0.80	1.60
NOM	S	4.00	1.40	1.20	1.80	
	TLN	T	4.00	1.40	1.20	2.80
NLJ	W	6.50	2.00	2.50	2.80	
	X	8.00	2.00	4.00	3.00	
	Y	8.00	2.00	4.00	3.00	
	TCN	K	4.00	1.40	1.20	1.80
		L	3.50	1.15	1.20	2.40
		M	2.30	0.90	0.50	1.10
N		2.00	0.70	0.60	1.10	
S		3.50	1.15	1.20	1.20	
T		3.50	1.15	1.20	2.40	
TCN	4	7.40	2.20	3.00	4.80	
	6	15.20	3.00	9.20	5.50	

Recommended Reflow Profile for Lead-Free Product

Allowable range of peak temp./ time combination for IR reflow

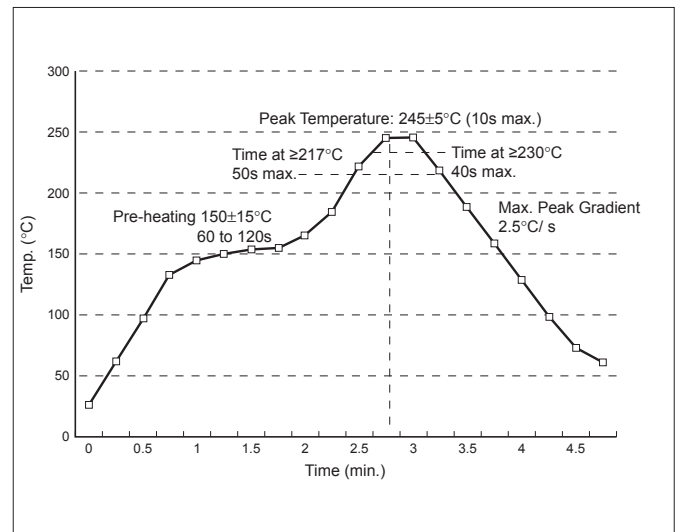

Please contact us for Lead-Free Products.

Manual Soldering Using Soldering Iron

Item	Condition
Max. Tip Temperature	370°C max.
Max. Exposure Time	3 sec. max.

Technical Summary

1. Voltage Derating

We can offer to use AVX software “Select-a-Cap” to select a part number for safety use.

2. Surge Current

As a general rule of thumb, the maximum current a tantalum capacitor can withstand is given by the following equation.

$$I_{max} = V_{rated} / (0.45 + \text{Catalog ESR})$$

So for example for TAJD226M035 (Catalog ESR = 0.9 Ohms)

This would be :

$$I_{max} = 35 / (0.45 + 0.9) \doteq 25.9A$$

3. If more aggressive mounting techniques are to be used, please contact AVX Tantalum for guidance.

4. Reverse Voltage

The values quoted are not intended to cover continuous reverse operation.

The peak reverse voltage applied to the capacitor must not exceed.

- 10% of rated DC voltage to a maximum of 1V at 25°C.
- 3% of rated DC voltage to a maximum of 0.5V at 85°C.
- 1% of rated DC voltage to a maximum of 0.1V at 105°C.
- 1% of category DC voltage to a maximum of 0.1V at 125°C.

X-ON Electronics

Largest Supplier of Electrical and Electronic Components

Click to view similar products for [Tantalum Capacitors - Solid SMD category:](#)

Click to view products by [Kyocera AVX manufacturer:](#)

Other Similar products are found below :

[CWR06HC106KB](#) [B45197-A2157-M509](#) [B45197A5226M409](#) [NTC-T476K10TRDF](#) [CWR06KC106KP](#) [CWR09KB106KCA](#)
[TCSCS1A336KBAR](#) [TCTP0J336M8R](#) [B45196-H5106-K309](#) [B45196-H6226-K509](#) [CWR09JC225JBB](#) [T83D475K050RCCL](#)
[TCSCS1A476KBAR](#) [T83E107K016RCCL](#) [T83D685K035RCCL](#) [595D107X0004B2T](#) [CWR11HH105KB](#) [293D155X9020A2DE3](#)
[CWR09NC224KB](#) [CWR11MC685KCB](#) [CWR29FC685KCEC](#) [CWR09NC684KM](#) [CWR19MH106KCHB](#) [CWR29HH155KCBB](#)
[CWR29HC106KCDC](#) [CWR29FC336KDGC](#) [CWR09NC225KDB](#) [CWR29FC475KDDC](#) [CWR29HC225KCAC](#) [CWR11KC106KBB](#)
[CWR09JH105KC](#) [293D476X9035E2TE3](#) [CWR29JC335KDDC](#) [CWR29KC226JCGC](#) [CWR29FC105KDAC](#) [CWR29DC337KCHC](#) [NTC-](#)
[T686K6.3TRBF](#) [595D686X9010B2T](#) [595D106X0025C8T](#) [TAZH685K035LBSB0824](#) [TAZG107K010LBSB0800](#) [TAZH475K050LBSB0H23](#)
[TAJD107K016KNJ](#) [TAZH227K010LBSB0024](#) [TAZH156K025CBSZ0824](#) [TAZH227J010LBSZ0800](#) [TPSE687M006H0045](#)
[TBJD156K025CBSZ0824](#) [TMCSA1V154MTRF](#) [TMCSA0G335MTRF](#)