

# TAJ Automotive Range

## Standard Tantalum - Automotive Product Range

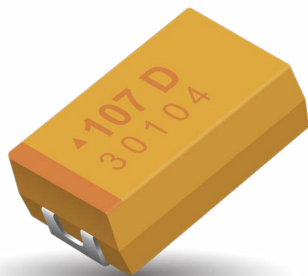

### FEATURES

- General Purpose SMT Chip Tantalum Series
- 100% Surge Current Tested
- 7 Case Sizes Available
- CV Range: 0.22-680µF / 6.3-50V



### APPLICATIONS

- Audio Systems
- GPS
- Seat Controls
- Dashboard

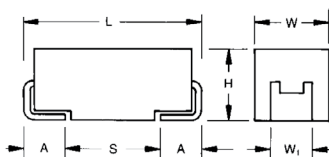

### CASE DIMENSIONS:

millimeters (inches)

Code	EIA Code	EIA Metric	L±0.20 (0.008)	W+0.20 (0.008) -0.10 (0.004)	H+0.20 (0.008) -0.10 (0.004)	W <sub>1</sub> ±0.20 (0.008)	A+0.30 (0.012) -0.20 (0.008)	S Min.
A	1206	3216-18	3.20 (0.126)	1.60 (0.063)	1.60 (0.063)	1.20 (0.047)	0.80 (0.031)	1.10 (0.043)
B	1210	3528-21	3.50 (0.138)	2.80 (0.110)	1.90 (0.075)	2.20 (0.087)	0.80 (0.031)	1.40 (0.055)
C	2312	6032-28	6.00 (0.236)	3.20 (0.126)	2.60 (0.102)	2.20 (0.087)	1.30 (0.051)	2.90 (0.114)
D	2917	7343-31	7.30 (0.287)	4.30 (0.169)	2.90 (0.114)	2.40 (0.094)	1.30 (0.051)	4.40 (0.173)
E	2917	7343-43	7.30 (0.287)	4.30 (0.169)	4.10 (0.162)	2.40 (0.094)	1.30 (0.051)	4.40 (0.173)
P	0805	2012-15	2.05 (0.081)	1.35 (0.053)	1.50 (0.059) max.	1.00±0.10 (0.039±0.004)	0.50 (0.020)	0.85 (0.033)
Y	2917	7343-20	7.30 (0.287)	4.30 (0.169)	2.00 (0.079)	2.40 (0.094)	1.30 (0.051)	4.40 (0.173)

W<sub>1</sub> dimension applies to the termination width for A dimensional area only.

### MARKING

#### A, B, C, D, E, Y CASE

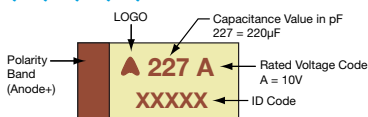

#### P CASE

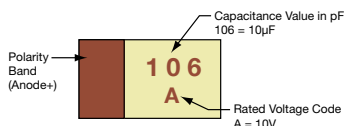

### HOW TO ORDER

**TAJ**  
Type

**C**  
Case Size  
See table above

**106**  
Capacitance Code  
pF code: 1st two digits represent significant figures, 3rd digit represents multiplier (number of zeros to follow)

**M**  
Tolerance  
K = ±10%  
M = ±20%

**035**  
Rated DC Voltage  
006 = 6.3Vdc  
010 = 10Vdc  
016 = 16Vdc  
020 = 20Vdc  
025 = 25Vdc  
035 = 35Vdc  
050 = 50Vdc

**T**  
Packaging  
T = Automotive Lead Free 7" Reel  
U = Automotive Lead Free 13" Reel

**NJ**  
Specification Suffix  
NJ = Std Suffix

**V**  
Dry Pack Option  
(D,E,Y case sizes mandatory)

### TECHNICAL SPECIFICATIONS

Technical Data:	All technical data relate to an ambient temperature of +25°C								
Capacitance Range:	0.22 µF to 680 µF								
Capacitance Tolerance:	±10%; ±20%								
Rated Voltage (V <sub>R</sub> )	≤ +85°C:	6.3	10	16	20	25	35	50	
Category Voltage (V <sub>C</sub> )	≤ +125°C:	4	7	10	13	17	23	33	
Surge Voltage (V <sub>S</sub> )	≤ +85°C:	8	13	20	26	32	46	65	
Surge Voltage (V <sub>S</sub> )	≤ +125°C:	5	8	13	16	20	28	40	
Temperature Range:	-55°C to +125°C								
Environmental Classification:	55/125/56 (IEC 68-2)								
Reliability:	1% per 1000 hours at 85°C, V <sub>R</sub> with 0.1Ω/V series impedance, 60% confidence level								
Termination Finished:	Sn Plating (standard), Gold and SnPb Plating upon request								
	Meets requirements of AEC-Q200								

# TAJ Automotive Range

## Standard Tantalum - Automotive Product Range

### TAJ AUTOMOTIVE RANGE CAPACITANCE AND RATED VOLTAGE RANGE (LETTER DENOTES CASE SIZE)

Capacitance		Rated voltage DC ( $V_R$ to 85°C)						
$\mu\text{F}$	Code	6.3V (J)	10V (A)	16V (C)	20V (D)	25V (E)	35V (V)	50V (T)
0.10	104							
0.15	154							
0.22	224							A
0.33	334						A	A
0.47	474					A	A	A/B
0.68	684					A	A	B
1.0	105			A	A	A	A/B	B/C
1.5	155				A	A/B	A/B	C
2.2	225		A	A	A/B	A/B	B/C	C/D
3.3	335	A		A/B	A/B	A/B	B/C	C/D
4.7	475		A/B	A/B	A/B	B/C	B/C/D	C/D
6.8	685		A/B	A/B	A/B/C	B/C	C/D	D
10	106	A/B	A/B/P	A/B/C	B/C	B/C/D	C/D/Y	D/E
15	156	A/P	A/B/C	B/C	B/C	C/D/Y	D/Y	E
22	226	A/B/C	A/B/C	B/C/D	B/C/D/Y	C/D/Y	D/E	
33	336	A/B	B/C	B/C/D/Y	C/D/Y	D	D/E	
47	476	A/B/C	B/C/D	C/D/Y	D/Y	D/E	E	
68	686	B/C	B/C/D/Y	C/D/Y	D/E	E		
100	107	B/C/D/Y	C/D/Y	D/E	E	E		
150	157	C/D/Y	D/E/Y	D/E				
220	227	C/D/Y	D/E	E				
330	337	D/E	D/E					
470	477	D/E						
680	687	D/E						

#### Released ratings

Note: Voltage ratings are minimum values. KYOCERA AVX reserves the right to supply higher voltage ratings in the same case size, to the same reliability standards.

# TAJ Automotive Range

## Standard Tantalum - Automotive Product Range

### RATINGS & PART NUMBER REFERENCE

Part Number	Case Size	Capacitance (µF)	Rated Voltage (V)	Rated Temperature (°C)	Category Voltage (V)	Category Temperature (°C)	DCL Max. (µA)	DF Max. (%)	ESR Max. @ 100kHz (Ω)	100kHz RMS Current (mA)			MSL
										25°C	85°C	125°C	
<b>6.3 Volt @ 85°C</b>													
TAJA335*006TNJ	A	3.3	6.3	85	4	125	0.5	6	7	104	93	41	1
TAJA106*006TNJ	A	10	6.3	85	4	125	0.6	6	4	137	123	55	1
TAJB106*006TNJ	B	10	6.3	85	4	125	0.5	6	3	168	151	67	1
TAJA156*006TNJ	A	15	6.3	85	4	125	0.9	6	3.5	146	132	59	1
TAJP156*006TNJ	P	15	6.3	85	4	125	0.9	8	3.5	131	118	52	1
TAJA226*006TNJ	A	22	6.3	85	4	125	1.4	6	3	158	142	63	1
TAJB226*006TNJ	B	22	6.3	85	4	125	1.4	6	2.5	184	166	74	1
TAJC226*006TNJ	C	22	6.3	85	4	125	1.4	6	2	235	211	94	1
TAJA336*006TNJ	A	33	6.3	85	4	125	2.1	8	2.2	185	166	74	1
TAJB336*006TNJ	B	33	6.3	85	4	125	2.1	6	2.2	197	177	79	1
TAJA476*006TNJ	A	47	6.3	85	4	125	2.8	10	1.6	217	195	87	1
TAJB476*006TNJ	B	47	6.3	85	4	125	3	6	2	206	186	82	1
TAJC476*006TNJ	C	47	6.3	85	4	125	3	6	1.6	262	236	105	1
TAJB686*006TNJ	B	68	6.3	85	4	125	4	8	0.9	307	277	123	1
TAJC686*006TNJ	C	68	6.3	85	4	125	4.3	6	1.5	271	244	108	1
TAJB107*006TNJ	B	100	6.3	85	4	125	6.3	10	1.4	246	222	99	1
TAJC107*006TNJ	C	100	6.3	85	4	125	6.3	6	0.9	350	315	140	1
TAJD107*006TNJV	D	100	6.3	85	4	125	6.3	6	0.9	408	367	163	3
TAJY107*006TNJV	Y	100	6.3	85	4	125	6.3	6	0.7	423	380	169	3
TAJC157*006TNJ	C	150	6.3	85	4	125	9.5	6	1.3	291	262	116	1
TAJD157*006TNJV	D	150	6.3	85	4	125	9.5	6	0.9	408	367	163	3
TAJY157*006TNJV	Y	150	6.3	85	4	125	9.5	6	0.4	559	503	224	3
TAJC227*006TNJ	C	220	6.3	85	4	125	8.8	8	1.2	303	272	121	1
TAJD227*006TNJV	D	220	6.3	85	4	125	13.9	8	0.4	612	551	245	3
TAJY227*006TNJV	Y	220	6.3	85	4	125	13.9	8	0.7	423	380	169	3
TAJD337*006TNJV	D	330	6.3	85	4	125	20.8	8	0.4	612	551	245	3
TAJE337*006TNJV	E	330	6.3	85	4	125	20.8	8	0.4	642	578	257	3
TAJD477*006TNJV	D	470	6.3	85	4	125	28	12	0.4	612	551	245	3
TAJE477*006TNJV	E	470	6.3	85	4	125	28	10	0.4	642	578	257	3
TAJD687*006TNJV	D	680	6.3	85	4	125	40.8	20	0.5	548	493	219	3
TAJE687*006TNJV	E	680	6.3	85	4	125	42.8	10	0.5	574	517	230	3
<b>10 Volt @ 85°C</b>													
TAJA225*010TNJ	A	2.2	10	85	7	125	0.5	6	7	104	93	41	1
TAJA475*010TNJ	A	4.7	10	85	7	125	0.5	6	5	122	110	49	1
TAJB475*010TNJ	B	4.7	10	85	7	125	0.5	6	4	146	131	58	1
TAJA685*010TNJ	A	6.8	10	85	7	125	0.7	6	4	137	123	55	1
TAJB685*010TNJ	B	6.8	10	85	7	125	0.7	6	3	168	151	67	1
TAJA106*010TNJ	A	10	10	85	7	125	1	6	3	158	142	63	1
TAJB106*010TNJ	B	10	10	85	7	125	1	6	2.1	201	181	80	1
TAJP106*010TNJ	P	10	10	85	7	125	1	8	6	100	90	40	1
TAJA156*010TNJ	A	15	10	85	7	125	1.5	6	3.2	153	138	61	1
TAJB156*010TNJ	B	15	10	85	7	125	1.5	6	2.8	174	157	70	1
TAJC156*010TNJ	C	15	10	85	7	125	1.5	6	2	235	211	94	1
TAJA226*010TNJ	A	22	10	85	7	125	2.2	8	3	158	142	63	1
TAJB226*010TNJ	B	22	10	85	7	125	2.2	6	2.4	188	169	75	1
TAJC226*010TNJ	C	22	10	85	7	125	2.2	6	1.8	247	222	99	1
TAJB336*010TNJ	B	33	10	85	7	125	3.3	6	1.8	217	196	87	1
TAJC336*010TNJ	C	33	10	85	7	125	3.3	6	1.6	262	236	105	1
TAJB476*010TNJ	B	47	10	85	7	125	4.7	8	1	292	262	117	1
TAJC476*010TNJ	C	47	10	85	7	125	4.7	6	1.2	303	272	121	1
TAJD476*010TNJV	D	47	10	85	7	125	4.7	6	0.4	612	551	245	3
TAJB686*010TNJ	B	68	10	85	7	125	6.8	8	1.4	246	222	99	1
TAJC686*010TNJ	C	68	10	85	7	125	6.8	6	1.3	291	262	116	1
TAJD686*010TNJV	D	68	10	85	7	125	6.8	6	0.9	408	367	163	3
TAJY686*010TNJV	Y	68	10	85	7	125	6.8	6	0.9	373	335	149	3
TAJC107*010TNJ	C	100	10	85	7	125	10	8	1.2	303	272	121	1
TAJD107*010TNJV	D	100	10	85	7	125	10	6	0.9	408	367	163	3
TAJY107*010TNJV	Y	100	10	85	7	125	10	6	0.9	373	335	149	3
TAJD157*010TNJV	D	150	10	85	7	125	15	8	0.9	408	367	163	3
TAJE157*010TNJV	E	150	10	85	7	125	15	8	0.9	428	385	171	3
TAJY157*010TNJV	Y	150	10	85	7	125	15	6	1.2	323	290	129	3
TAJD227*010TNJV	D	220	10	85	7	125	22	8	0.5	548	493	219	3
TAJE227*010TNJV	E	220	10	85	7	125	22	8	0.5	574	517	230	3
TAJD337*010TNJV	D	330	10	85	7	125	33	8	0.9	408	367	163	3
TAJE337*010TNJV	E	330	10	85	7	125	33	8	0.9	428	385	171	3
<b>16 Volt @ 85°C</b>													
TAJA105*016TNJ	A	1	16	85	10	125	0.5	4	11	83	74	33	1
TAJA225*016TNJ	A	2.2	16	85	10	125	0.5	6	6.5	107	97	43	1
TAJA335*016TNJ	A	3.3	16	85	10	125	0.5	6	5	122	110	49	1
TAJB335*016TNJ	B	3.3	16	85	10	125	0.5	6	4.5	137	124	55	1
TAJA475*016TNJ	A	4.7	16	85	10	125	0.8	6	4	137	123	55	1

# TAJ Automotive Range

## Standard Tantalum - Automotive Product Range



### RATINGS & PART NUMBER REFERENCE

Part Number	Case Size	Capacitance (µF)	Rated Voltage (V)	Rated Temperature (°C)	Category Voltage (V)	Category Temperature (°C)	DCL Max. (µA)	DF Max. (%)	ESR Max. @ 100kHz (Ω)	100kHz RMS Current (mA)			MSL
										25°C	85°C	125°C	
TAJB475*016TNJ	B	4.7	16	85	10	125	0.8	6	3.5	156	140	62	1
TAJA685*016TNJ	A	6.8	16	85	10	125	1.1	6	3.5	146	132	59	1
TAJB685*016TNJ	B	6.8	16	85	10	125	1.1	6	2.5	184	166	74	1
TAJA106*016TNJ	A	10	16	85	10	125	1.6	6	3	158	142	63	1
TAJB106*016TNJ	B	10	16	85	10	125	1.6	6	2.5	184	166	74	1
TAJC106*016TNJ	C	10	16	85	10	125	1.6	6	2	235	211	94	1
TAJB156*016TNJ	B	15	16	85	10	125	2.4	6	2.5	184	166	74	1
TAJC156*016TNJ	C	15	16	85	10	125	2.4	6	1.8	247	222	99	1
TAJB226*016TNJ	B	22	16	85	10	125	3.5	6	2.3	192	173	77	1
TAJC226*016TNJ	C	22	16	85	10	125	3.5	6	1	332	298	133	1
TAJD226*016TNJV	D	22	16	85	10	125	3.5	6	1.1	369	332	148	3
TAJB336*016TNJ	B	33	16	85	10	125	5.3	8	2.1	201	181	80	1
TAJC336*016TNJ	C	33	16	85	10	125	5.3	6	1.5	271	244	108	1
TAJD336*016TNJV	D	33	16	85	10	125	5.3	6	0.9	408	367	163	3
TAJY336*016TNJV	Y	33	16	85	10	125	5.3	6	0.9	373	335	149	3
TAJC476*016TNJ	C	47	16	85	10	125	7.5	6	0.5	469	422	188	1
TAJD476*016TNJV	D	47	16	85	10	125	7.5	6	0.9	408	367	163	3
TAJY476*016TNJV	Y	47	16	85	10	125	7.5	6	0.7	423	380	169	3
TAJC686*016TNJ	C	68	16	85	10	125	10.9	6	1.3	291	262	116	1
TAJD686*016TNJV	D	68	16	85	10	125	10.9	6	0.9	408	367	163	3
TAJY686*016TNJV	Y	68	16	85	10	125	10.9	6	0.9	373	335	149	3
TAJD107*016TNJV	D	100	16	85	10	125	16	6	0.6	500	450	200	3
TAJE107*016TNJV	E	100	16	85	10	125	16	6	0.9	428	385	171	3
TAJD157*016TNJV	D	150	16	85	10	125	24	6	0.9	408	367	163	3
TAJE157*016TNJV	E	150	16	85	10	125	24	8	0.3	742	667	297	3
TAJE227*016TNJV	E	220	16	85	10	125	35.2	10	0.5	574	517	230	3
<b>20 Volt @ 85°C</b>													
TAJA105*020TNJ	A	1	20	85	13	125	0.5	4	9	91	82	37	1
TAJA155*020TNJ	A	1.5	20	85	13	125	0.5	6	6.5	107	97	43	1
TAJA225*020TNJ	A	2.2	20	85	13	125	0.5	6	5.3	119	107	48	1
TAJB225*020TNJ	B	2.2	20	85	13	125	0.5	6	3.5	156	140	62	1
TAJA335*020TNJ	A	3.3	20	85	13	125	0.7	6	4.5	129	116	52	1
TAJB335*020TNJ	B	3.3	20	85	13	125	0.7	6	3	168	151	67	1
TAJA475*020TNJ	A	4.7	20	85	13	125	0.9	6	4	137	123	55	1
TAJB475*020TNJ	B	4.7	20	85	13	125	0.9	6	3	168	151	67	1
TAJA685*020TNJ	A	6.8	20	85	13	125	1.4	6	2.4	177	159	71	1
TAJB685*020TNJ	B	6.8	20	85	13	125	1.4	6	2.5	184	166	74	1
TAJC685*020TNJ	C	6.8	20	85	13	125	1.4	6	2	235	211	94	1
TAJB106*020TNJ	B	10	20	85	13	125	2	6	2.1	201	181	80	1
TAJC106*020TNJ	C	10	20	85	13	125	2	6	1.2	303	272	121	1
TAJB156*020TNJ	B	15	20	85	13	125	3	6	2	206	186	82	1
TAJC156*020TNJ	C	15	20	85	13	125	3	6	1.7	254	229	102	1
TAJB226*020TNJ	B	22	20	85	13	125	4.4	6	1.8	217	196	87	1
TAJC226*020TNJ	C	22	20	85	13	125	4.4	6	1.6	262	236	105	1
TAJD226*020TNJV	D	22	20	85	13	125	4.4	6	0.9	408	367	163	3
TAJY226*020TNJV	Y	22	20	85	13	125	4.4	6	0.9	373	335	149	3
TAJC336*020TNJ	C	33	20	85	13	125	6.6	6	1.5	271	244	108	1
TAJD336*020TNJV	D	33	20	85	13	125	6.6	6	0.9	408	367	163	3
TAJY336*020TNJV	Y	33	20	85	13	125	6.6	6	0.6	456	411	183	3
TAJD476*020TNJV	D	47	20	85	13	125	9.4	6	0.9	408	367	163	3
TAJY476*020TNJV	Y	47	20	85	13	125	9.4	6	0.9	373	335	149	3
TAJD686*020TNJV	D	68	20	85	13	125	13.6	6	0.4	612	551	245	3
TAJE686*020TNJV	E	68	20	85	13	125	13.6	6	0.9	428	385	171	3
TAJE107*020TNJV	E	100	20	85	13	125	20	6	0.4	642	578	257	3
<b>25 Volt @ 85°C</b>													
TAJA474*025TNJ	A	0.47	25	85	17	125	0.5	4	14	73	66	29	1
TAJA684*025TNJ	A	0.68	25	85	17	125	0.5	4	10	87	78	35	1
TAJA105*025TNJ	A	1	25	85	17	125	0.5	4	8	97	87	39	1
TAJA155*025TNJ	A	1.5	25	85	17	125	0.5	6	7.5	100	90	40	1
TAJB155*025TNJ	B	1.5	25	85	17	125	0.5	6	5	130	117	52	1
TAJA225*025TNJ	A	2.2	25	85	17	125	0.6	6	7	104	93	41	1
TAJB225*025TNJ	B	2.2	25	85	17	125	0.6	6	4.5	137	124	55	1
TAJA335*025TNJ	A	3.3	25	85	17	125	0.8	6	3.7	142	128	57	1
TAJB335*025TNJ	B	3.3	25	85	17	125	0.8	6	3.5	156	140	62	1
TAJB475*025TNJ	B	4.7	25	85	17	125	1.2	6	1.5	238	214	95	1
TAJC475*025TNJ	C	4.7	25	85	17	125	1.2	6	2.4	214	193	86	1
TAJB685*025TNJ	B	6.8	25	85	17	125	1.7	6	2.8	174	157	70	1
TAJC685*025TNJ	C	6.8	25	85	17	125	1.7	6	2	235	211	94	1
TAJB106*025TNJ	B	10	25	85	17	125	2.5	6	2.5	184	166	74	1
TAJC106*025TNJ	C	10	25	85	17	125	2.5	6	1.8	247	222	99	1
TAJD106*025TNJV	D	10	25	85	17	125	2.5	6	1.2	354	318	141	3
TAJC156*025TNJ	C	15	25	85	17	125	3.8	6	1.6	262	236	105	1

The Important Information/Disclaimer is incorporated in the catalog where these specifications came from or available online at [www.kyocera-avx.com/disclaimer/](http://www.kyocera-avx.com/disclaimer/) by reference and should be reviewed in full before placing any order.

# TAJ Automotive Range

## Standard Tantalum - Automotive Product Range

### RATINGS & PART NUMBER REFERENCE

Part Number	Case Size	Capacitance (µF)	Rated Voltage (V)	Rated Temperature (°C)	Category Voltage (V)	Category Temperature (°C)	DCL Max. (µA)	DF Max. (%)	ESR Max. @ 100kHz (Ω)	100kHz RMS Current (mA)			MSL
										25°C	85°C	125°C	
TAJD156*025TNJV	D	15	25	85	17	125	3.8	6	1	387	349	155	3
TAJY156*025TNJV	Y	15	25	85	17	125	3.8	6	1	354	318	141	3
TAJC226*025TNJ	C	22	25	85	17	125	5.5	6	1.4	280	252	112	1
TAJD226*025TNJV	D	22	25	85	17	125	5.5	6	0.9	408	367	163	3
TAJY226*025TNJV	Y	22	25	85	17	125	5.5	6	0.8	395	356	158	3
TAJD336*025TNJV	D	33	25	85	17	125	8.3	6	0.9	408	367	163	3
TAJD476*025TNJV	D	47	25	85	17	125	11.8	6	0.9	408	367	163	3
TAJE476*025TNJV	E	47	25	85	17	125	11.8	6	0.9	428	385	171	3
TAJE686*025TNJV	E	68	25	85	17	125	17	6	0.9	428	385	171	3
TAJE107*025TNJV	E	100	25	85	17	125	25	10	0.3	742	667	297	3
<b>35 Volt @ 85°C</b>													
TAJA334*035TNJ	A	0.33	35	85	23	125	0.5	4	15	71	64	28	1
TAJA474*035TNJ	A	0.47	35	85	23	125	0.5	4	12	79	71	32	1
TAJA684*035TNJ	A	0.68	35	85	23	125	0.5	4	8	97	87	39	1
TAJA105*035TNJ	A	1	35	85	23	125	0.5	4	7.5	100	90	40	1
TAJB105*035TNJ	B	1	35	85	23	125	0.5	4	6.5	114	103	46	1
TAJA155*035TNJ	A	1.5	35	85	23	125	0.5	6	7.5	100	90	40	1
TAJB155*035TNJ	B	1.5	35	85	23	125	0.5	6	5.2	128	115	51	1
TAJB225*035TNJ	B	2.2	35	85	23	125	0.8	6	4.2	142	128	57	1
TAJC225*035TNJ	C	2.2	35	85	23	125	0.8	6	3.5	177	160	71	1
TAJB335*035TNJ	B	3.3	35	85	23	125	1.2	6	3.5	156	140	62	1
TAJC335*035TNJ	C	3.3	35	85	23	125	1.2	6	2.5	210	189	84	1
TAJB475*035TNJ	B	4.7	35	85	23	125	1.6	6	3.1	166	149	66	1
TAJC475*035TNJ	C	4.7	35	85	23	125	1.6	6	2.2	224	201	89	1
TAJD475*035TNJV	D	4.7	35	85	23	125	1.6	6	1.5	316	285	126	3
TAJC685*035TNJ	C	6.8	35	85	23	125	2.4	6	1.8	247	222	99	1
TAJD685*035TNJV	D	6.8	35	85	23	125	2.4	6	1.3	340	306	136	3
TAJC106*035TNJ	C	10	35	85	23	125	3.5	6	1.6	262	236	105	1
TAJD106*035TNJV	D	10	35	85	23	125	3.5	6	1	387	349	155	3
TAJY106*035TNJV	Y	10	35	85	23	125	3.5	6	1	354	318	141	3
TAJD156*035TNJV	D	15	35	85	23	125	5.3	6	0.9	408	367	163	3
TAJY156*035TNJV	Y	15	35	85	23	125	5.3	6	0.6	456	411	183	3
TAJD226*035TNJV	D	22	35	85	23	125	7.7	6	0.9	408	367	163	3
TAJE226*035TNJV	E	22	35	85	23	125	7.7	6	0.5	574	517	230	3
TAJD336*035TNJV	D	33	35	85	23	125	11.6	6	0.9	408	367	163	3
TAJE336*035TNJV	E	33	35	85	23	125	11.6	6	0.9	428	385	171	3
TAJE476*035TNJV	E	47	35	85	23	125	16.5	6	0.9	428	385	171	3
<b>50 Volt @ 85°C</b>													
TAJA224*050TNJ	A	0.22	50	85	33	125	0.5	4	18	65	58	26	1
TAJA334*050TNJ	A	0.33	50	85	33	125	0.5	4	17	66	60	27	1
TAJA474*050TNJ	A	0.47	50	85	33	125	0.5	4	9.5	89	80	36	1
TAJB474*050TNJ	B	0.47	50	85	33	125	0.5	4	9.5	95	85	38	1
TAJB684*050TNJ	B	0.68	50	85	33	125	0.5	4	8	103	93	41	1
TAJB105*050TNJ	B	1	50	85	33	125	0.5	6	7	110	99	44	1
TAJC105*050TNJ	C	1	50	85	33	125	0.5	4	5.5	141	127	57	1
TAJC155*050TNJ	C	1.5	50	85	33	125	0.8	6	4.5	156	141	63	1
TAJC225*050TNJ	C	2.2	50	85	33	125	1.1	8	2.5	210	189	84	1
TAJD225*050TNJV	D	2.2	50	85	33	125	1.1	6	2.5	245	220	98	3
TAJC335*050TNJ	C	3.3	50	85	33	125	1.6	6	2.5	210	189	84	1
TAJD335*050TNJV	D	3.3	50	85	33	125	1.7	6	2	274	246	110	3
TAJC475*050TNJ	C	4.7	50	85	33	125	2.4	6	1.4	280	252	112	1
TAJD475*050TNJV	D	4.7	50	85	33	125	2.4	6	1.4	327	295	131	3
TAJD685*050TNJV	D	6.8	50	85	33	125	3.4	6	1	387	349	155	3
TAJD106*050TNJV	D	10	50	85	33	125	5	6	0.8	433	390	173	3
TAJE106*050TNJV	E	10	50	85	33	125	5	6	1	406	366	162	3
TAJE156*050TNJV	E	15	50	85	33	125	7.5	6	0.6	524	472	210	3

Moisture Sensitivity Level (MSL) is defined according to J-STD-020

\*Please use "U" instead of "T" in the suffix letter for 13" reel packaging

**Please use specific PN for automotive version – see "HOW TO ORDER".**

All technical data relates to an ambient temperature of +25°C. Capacitance and DF are measured at 120Hz, 0.5V RMS with a maximum DC bias of 2.2 volts.

DCL is measured at rated voltage after 5 minutes.

For typical weight and composition see page 259.

**NOTE: KYOCERA AVX reserves the right to supply higher voltage ratings or tighter tolerance part in the same case size, to the same reliability standards.**

# TAJ Automotive Range

## Standard Tantalum - Automotive Product Range

### QUALIFICATION TABLE

TEST	TAJ automotive series (Temperature range -55°C to +125°C)									
	Condition			Characteristics						
<b>Endurance</b>	Apply rated voltage (Ur) at 85°C and / or category voltage (Uc) at 125°C for 2000 hours through a circuit impedance of $\leq 0.1\Omega/V$ . Stabilize at room temperature for 1-2 hours before measuring.			Visual examination	no visible damage					
				DCL	1.25 x initial limit					
				$\Delta C/C$	within $\pm 10\%$ of initial value					
				DF	initial limit					
				ESR	initial limit					
<b>Storage Life</b>	Store at 125°C, no voltage applied, for 2000 hours. Stabilize at room temperature for 1-2 hours before measuring.			Visual examination	no visible damage					
				DCL	1.25 x initial limit					
				$\Delta C/C$	within $\pm 10\%$ of initial value					
				DF	initial limit					
				ESR	initial limit					
<b>Humidity</b>	Store at 65°C and 95% relative humidity for 500 hours, with no applied voltage. Stabilize at room temperature and humidity for 1-2 hours before measuring.			Visual examination	no visible damage					
				DCL	1.5 x initial limit					
				$\Delta C/C$	within $\pm 10\%$ of initial value					
				DF	1.2 x initial limit					
				ESR	initial limit					
<b>Biased Humidity</b>	Apply rated voltage (Ur) at 85°C, 85% relative humidity for 1000 hours. Stabilize at room temperature and humidity for 1-2 hours before measuring.			Visual examination	no visible damage					
				DCL	2 x initial limit					
				$\Delta C/C$	within $\pm 10\%$ of initial value					
				DF	1.2 x initial limit					
				ESR	initial limit					
<b>Temperature Stability</b>	Step	Temperature°C	Duration(min)		+20°C	-55°C	+20°C	+85°C	+125°C	+20°C
	1	+20	15	DCL	IL*	n/a	IL*	10 x IL*	12.5 x IL*	IL*
	2	-55	15		$\Delta C/C$	n/a	+0/-10%	$\pm 5\%$	+10/-0%	+12/-0%
	3	+20	15	DF		IL*	1.5 x IL*	IL*	1.5 x IL*	2 x IL*
	4	+85	15	ESR	IL*	2 x IL*	IL*	IL*	IL*	IL*
	5	+125	15							
	6	+20	15							
<b>Surge Voltage</b>	Apply 1.3x category voltage (Uc) at 125°C for 1000 cycles of duration 6 min (30 sec charge, 5 min 30 sec discharge) through a charge / discharge resistance of 1000 $\Omega$			Visual examination	no visible damage					
				DCL	initial limit					
				$\Delta C/C$	within $\pm 5\%$ of initial value					
				DF	initial limit					
				ESR	initial limit					
<b>Mechanical Shock</b>	MIL-STD-202, Method 213, Condition F			Visual examination	no visible damage					
				DCL	initial limit					
				$\Delta C/C$	within $\pm 5\%$ of initial value					
				DF	initial limit					
				ESR	initial limit					
<b>Vibration</b>	MIL-STD-202, Method 204, Condition D			Visual examination	no visible damage					
				DCL	initial limit					
				$\Delta C/C$	within $\pm 5\%$ of initial value					
				DF	initial limit					
				ESR	initial limit					

\*Initial Limit

# TAJ Automotive Range

## Standard Tantalum - Automotive Product Range

### SOLID ELECTROLYTIC CAPACITOR ROADMAP

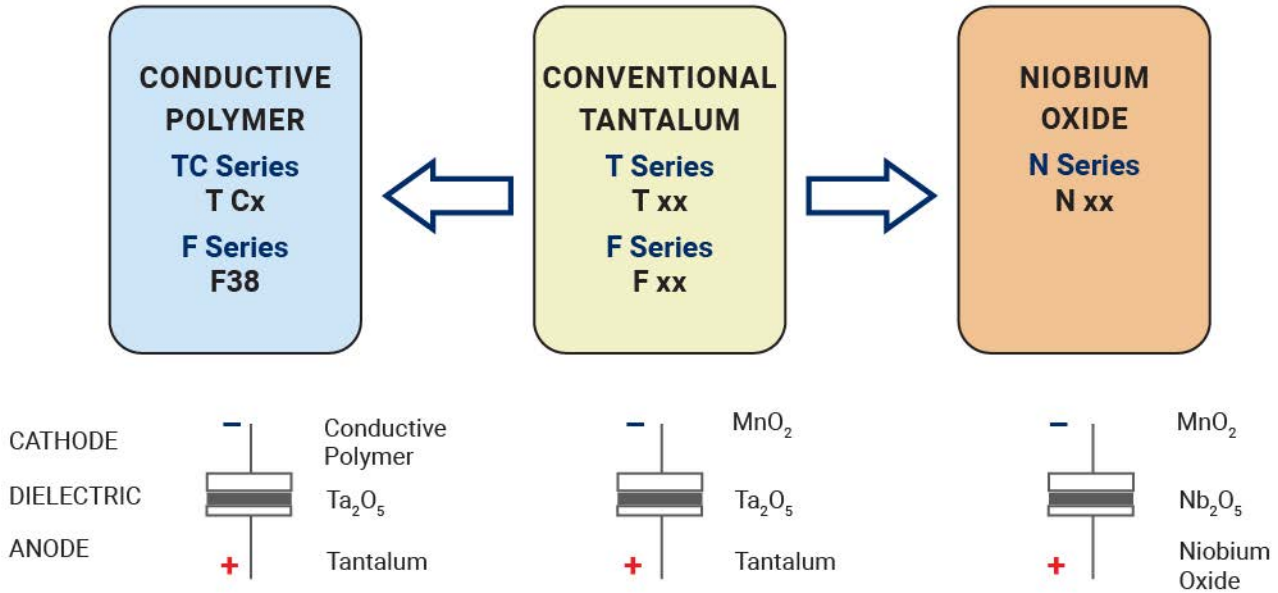

### FIVE CAPACITOR CONSTRUCTION STYLES

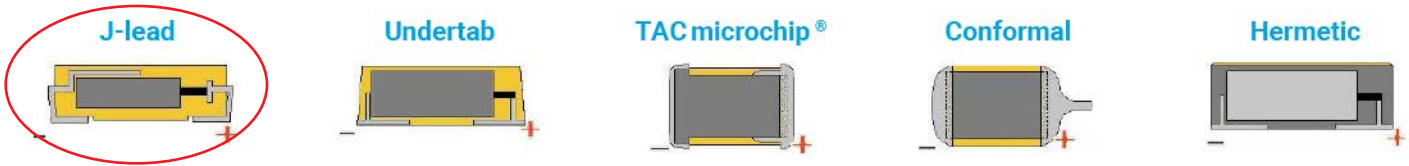

### SERIES LINE UP: CONVENTIONAL SMD MnO<sub>2</sub>

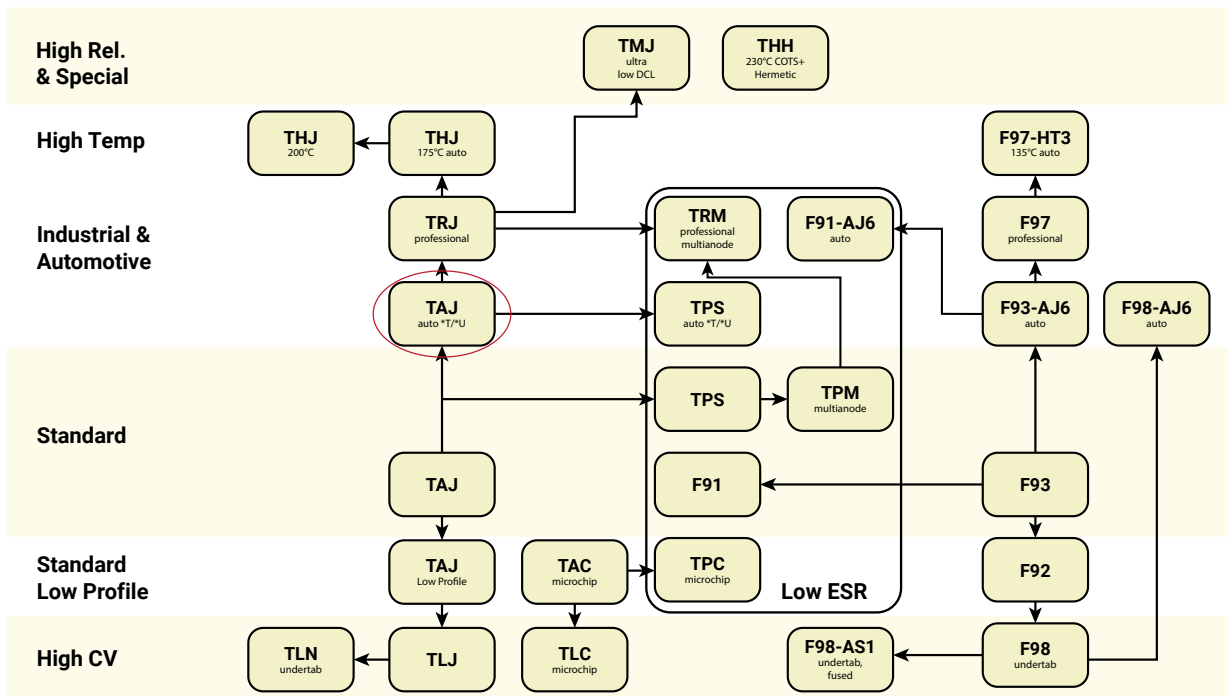



## X-ON Electronics

Largest Supplier of Electrical and Electronic Components

*Click to view similar products for [Tantalum Capacitors - Solid SMD category:](#)*

*Click to view products by [Kyocera AVX manufacturer:](#)*

Other Similar products are found below :

[CWR09DC226KBB-TR25](#) [CWR09FC476KB-TR25](#) [CWR09HC106KR-TR25](#) [CWR09HK106KB-TR25](#) [CWR09KC156KP](#)  
[CWR09MC335KCB](#) [CWR09MC335KCB\TR](#) [CWR09NC335MM](#) [CWR11HC105KB](#) [B45197-A2157-M509](#) [B45197A5226M409](#) [NTC-](#)  
[T476K10TRDF](#) [CWR06KC106KP](#) [CWR09DC476KC-TR25](#) [CWR09FC105KB-TR25](#) [CWR09HC226KB-TR25](#) [CWR09JC685KCA-TR25](#)  
[CWR09JK105KB-TR25](#) [CWR09JK156MM](#) [CWR09KB106KCA](#) [CWR09KC106KBC-TR25](#) [CWR09KC106KCB\W](#) [CWR09KC156JBB-](#)  
[TR25](#) [CWR11MH685KBA](#) [CWR19FC107KBGB](#) [CWR19HC226KBFB](#) [CWR29JC226KBHC-TR25](#) [TCP0J685M8R](#) [TCSCS1A336KBAR](#)  
[B45196-H5106-K309](#) [B45196-H6226-K509](#) [T495X106K035ATE2507005](#) [CWR06KC106KR](#) [CWR09JC225JBB](#) [TAJB106M016R](#)  
[TCSCS1A476KBAR](#) [T83E107K016RCCL](#) [T83D685K035RCCL](#) [CWR11JC225KB](#) [CWR11HH105KB](#) [293D475X0035B2DE3](#)  
[293D155X9020A2DE3](#) [CWR29FC106KDBC](#) [CWR09NC224KB](#) [CWR09NC684KM](#) [CWR29HH155KCBB](#) [CWR29HC106KCDC](#)  
[CWR29FC336KDGC](#) [CWR09NC225KDB](#) [CWR29FC475KDDC](#)