

Part No. X9000294-W3DRMB

External Hinged Wi-Fi Dual Band Antenna

2.4 GHz, 5 GHz

Supports : Wi-Fi applications, Agriculture, Automotive, Bluetooth, ZigBee, WLAN, Smart Home, HealthCare, Gateways, Routers



External Wi-Fi Dual Band Antenna

2.4 GHz, 5 GHz

KEY BENEFITS

Quicker Time-to-Market

Standard part means fewer design changes. Quickly implementation Easy Assembly using RP-SMA or SMA

Best in Class Performance

External antennas are designed to maintain high efficiency in a variety of device configurations

RoHS Compliant

Products are the latest RoHS version compliant

APPLICATIONS

- Embedded design
- Bluetooth Gateway, Access Point
- Handheld Telematics Tracking
- Healthcare M2M, Industrial devices
- Smart Grid OBD-II
- IoT

X9000294 is a hinged dipole antenna that can be mounted easily with RP-SMA male connector. It is ideal for Wi-Fi applications, Bluetooth, ZigBee, and LAN applications and with the high gain performance, it ensures reliable communications in both 2.4 GHz and 5GHz bands.

Extensive RF Experience

Our external antennas are supported by documentation and, when needed, by the expertise of RF engineers who have integrated hundreds of antenna designs into wireless devices.

Global Operations & Design Support

KYOCERA AVX' global operations encompass an integrated network of design centers that provide local customer support.

Electrical Specifications

Typical Characteristics in Free Space, tested in 90° bent position

Frequency (GHz)	2.400 – 2.485	5.150 – 5.850
Return Loss	<-12 dB	<-9 dB
Peak Gain	3.2 dBi	4.5 dBi
Average Efficiency	75%	60%
Polarization	Vertical	
Feed Point Impedance	50 ohm	

Mechanical Specifications & Ordering Part Number

Ordering Part Number	X9000294-W3DRMB
Dimensions (mm)	157.50 ± 3.00 height 17.65 ± 0.20 width
Connector Type	RP-SMA Male
Weight (grams)	5
Hinge	Foldable 90° at the hinge level
Color	Black (white is available upon request)
Operating Temperature (°C)	-40 to +120
Radome Material	TPEE

2.4 / 5 GHz External Hinged Wi-Fi antenna specifications
 KYOCERA AVX produces a wide variety of standard and custom antennas to meet user needs

Return Loss, Efficiency, and Peak Gain Plots

Typical performance, measured in free space, in 90° bent position

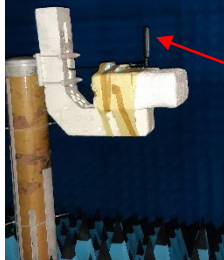

X9000294-W3DRMB

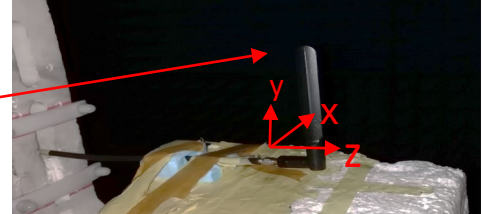

2.4 GHz Return Loss

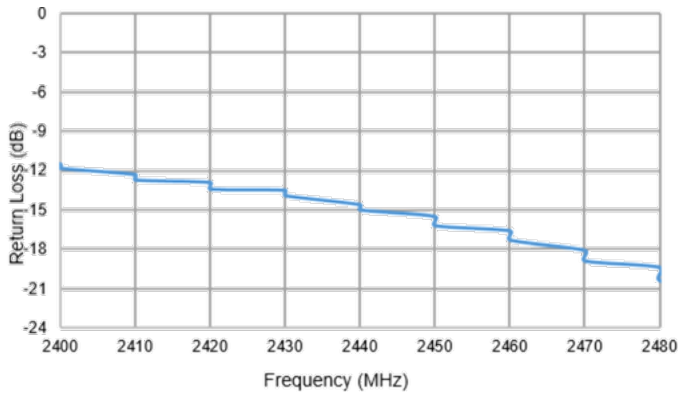

5 GHz Return Loss

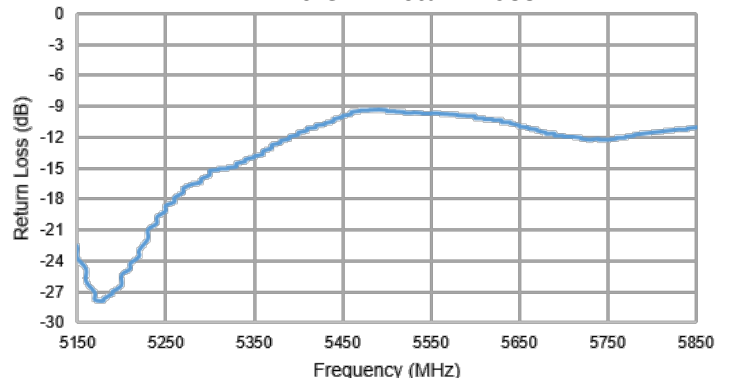

2.4 GHz Efficiency

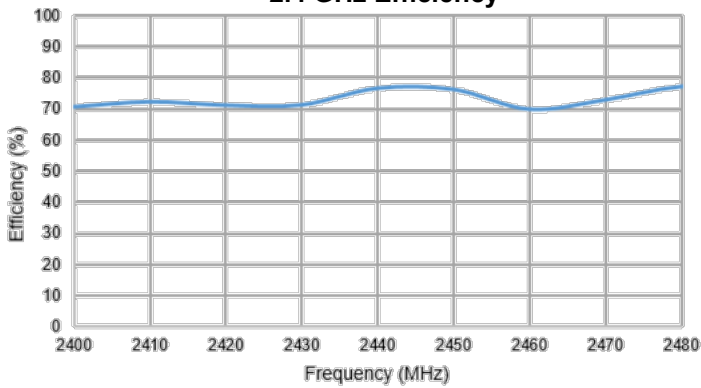

5 GHz Efficiency

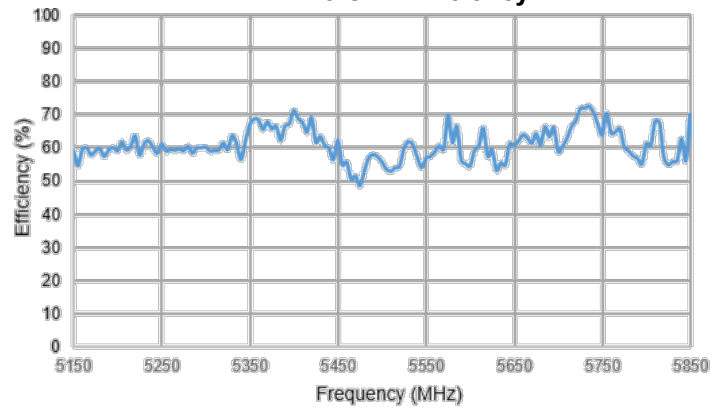

2.4 GHz Peak Gain

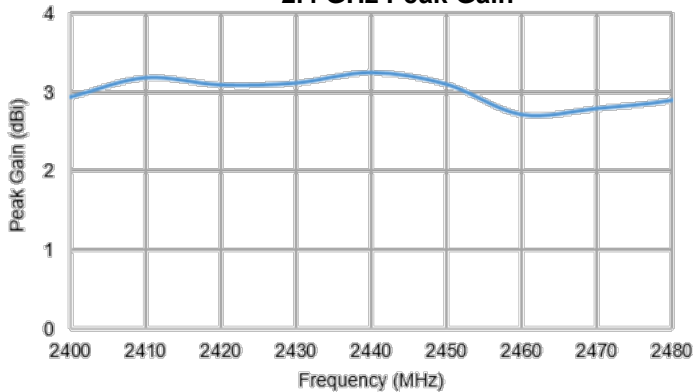

5 GHz Peak Gain

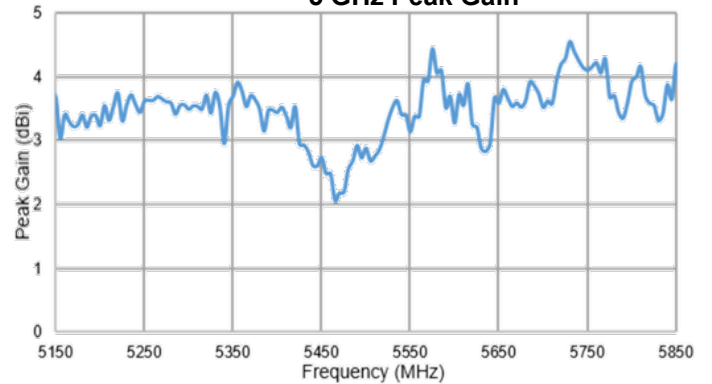

2.4 / 5 GHz External Hinged Wi-Fi antenna specifications
 KYOCERA AVX produces a wide variety of standard and custom antennas to meet user needs

Radiation Patterns Plots

Typical performance, measured in free space, in 90° bent position
 Measured at 2.440 GHz, 5.550 GHz

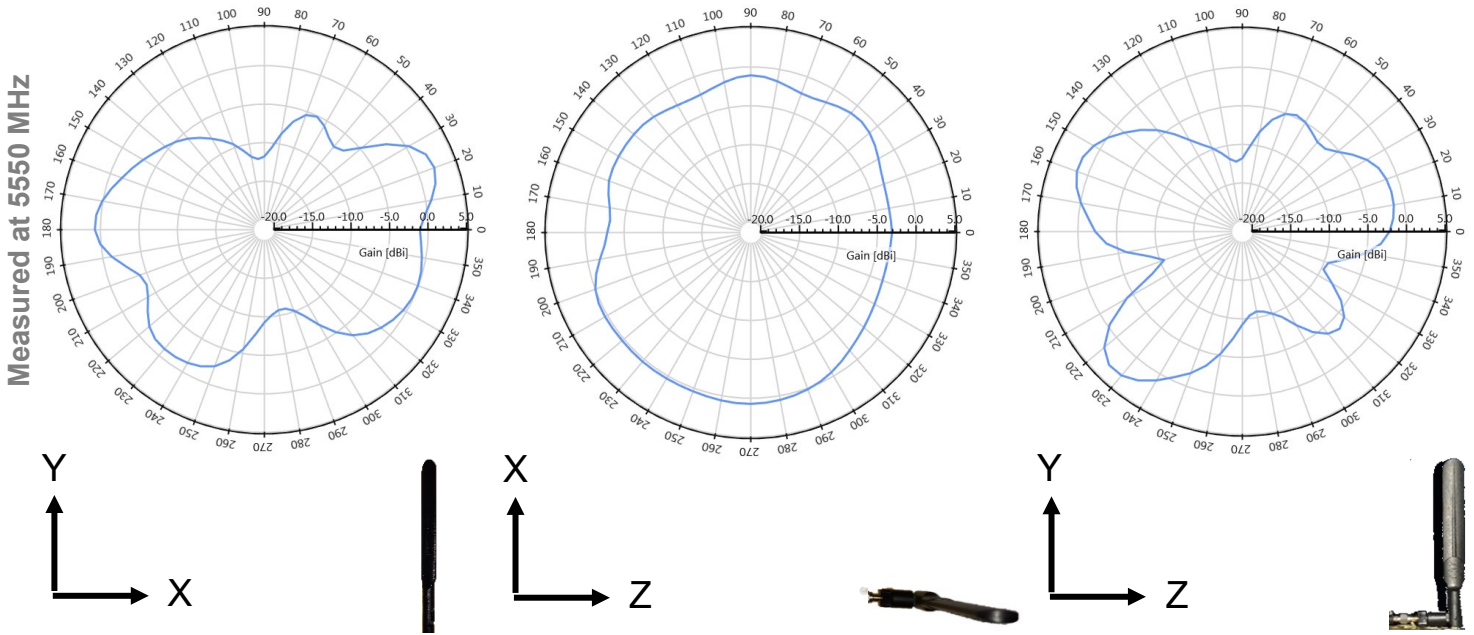
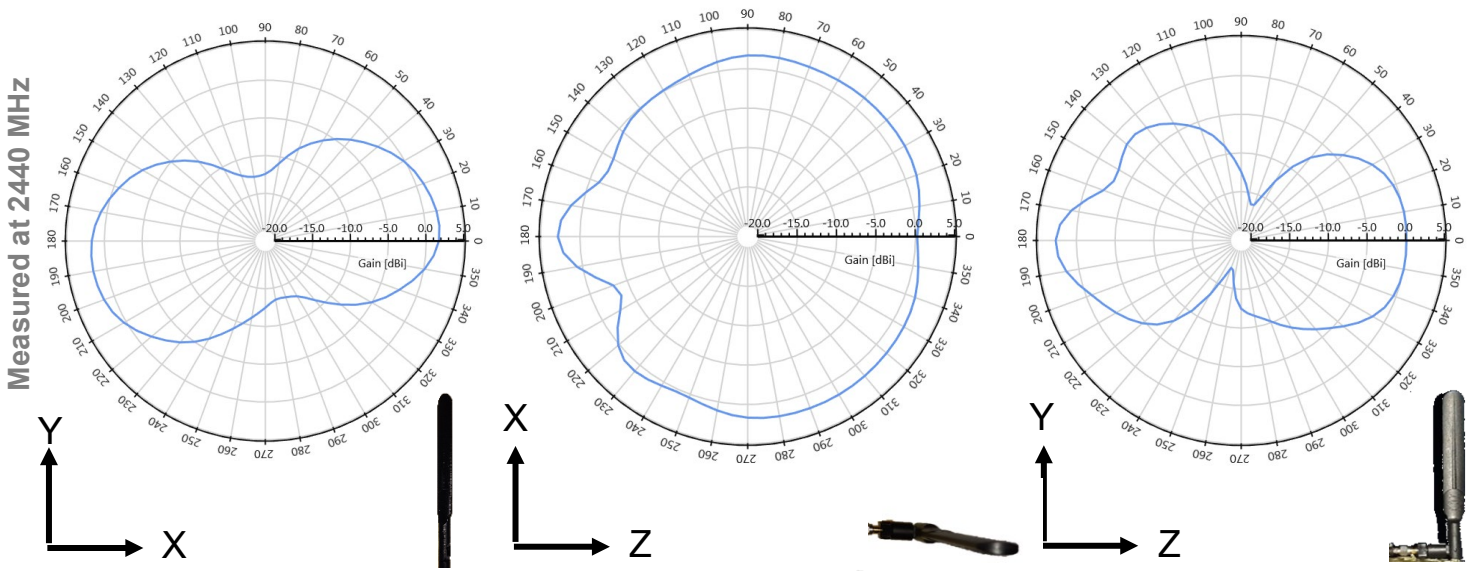

2.4 / 5 GHz External Hinged Wi-Fi antenna specifications
 KYOCERA AVX produces a wide variety of standard and custom antennas to meet user needs

Mechanical Specifications

Typical antenna dimensions in mm

Part Number	A (mm)	B (mm)	C (mm)	D (mm)	E (mm)	Connector
X9000294-W3DSMB	157.50 ± 3.00	17.60 ± 0.20	127.00 ± 2.00	5.60 ± 0.10	116.00 ± 0.20	RP-SMA Male

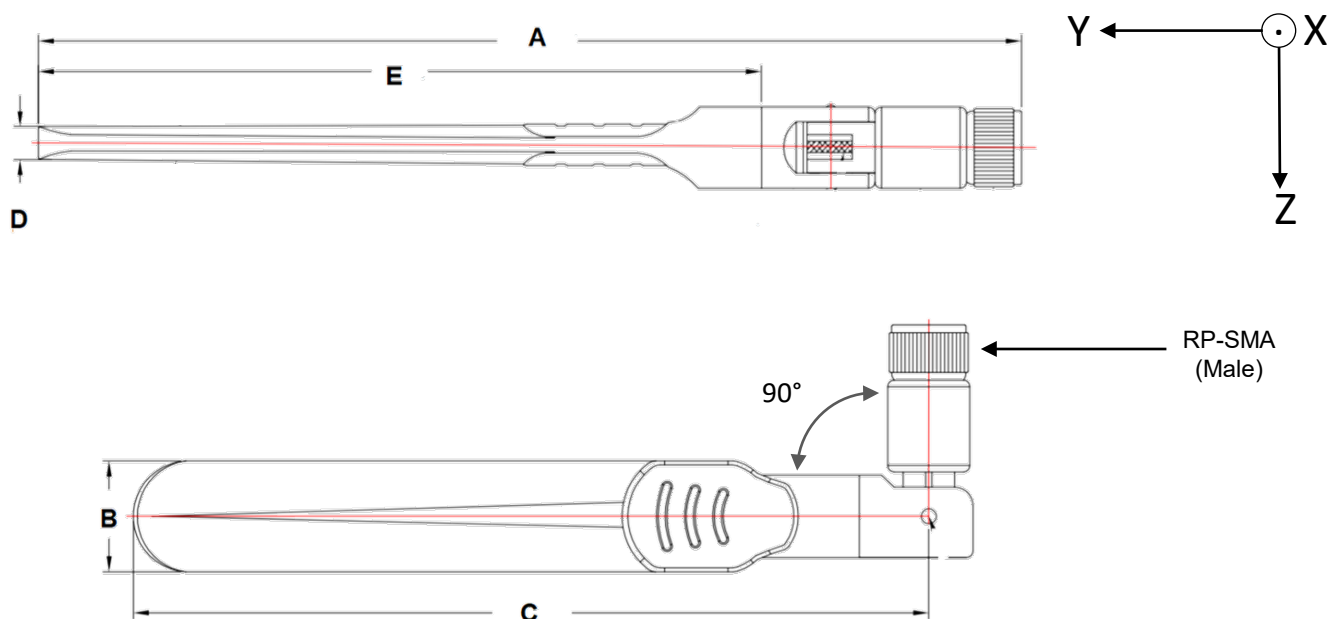

X-ON Electronics

Largest Supplier of Electrical and Electronic Components

Click to view similar products for [Antennas](#) category:

Click to view products by [Kyocera AVX](#) manufacturer:

Other Similar products are found below :

[930-033-R](#) [EXE902SM](#) [APAMPG-117](#) [108-00014-50](#) [66089-2406](#) [SPDA17RP918](#) [A09-F5NF-M](#) [RGFRA1903041A1T](#) [108-00016-050](#)
[SIMNA-868](#) [SIMNA-915](#) [SIMNA-433](#) [W1049B090](#) [TRABT1560](#) [W3118A](#) [WTL2449CQ1-FRSMM](#) [CPL9C](#) [0600-00060](#) [Y4503](#) [GD5W-](#)
[28P-NF](#) [PAL90209H-FNF](#) [GD53-25](#) [C37](#) [MAF94051](#) [S9025PLSMF](#) [EXD420PL](#) [B1322NR](#) [QWFTB120](#) [MAF94300](#) [MIKROE-2393](#) [DA5-](#)
[32RADOME](#) [BB1442NR](#) [5200227](#) [GPSCPMM00](#) [ANTDOM-05-01-WPM](#) [ANT-WP868SMA-Y](#) [EXW30BNX](#) [ANTX100ETBAB24553](#)
[S4908WBFNM](#) [GD57-21](#) [001-0016](#) [5700028](#) [B4305CN](#) [108-00032-010](#) [C27](#) [C27S](#) [CBNC58](#) [EXC902SM](#) [CB27](#) [ABFT](#)