



# 深圳市凯越翔电子有限公司

## 石英谐振器规格书

产品名称:	石英晶振谐振器
产品型号:	2012/32.768 KHZ
产品参数:	12.5PF/±20ppm
原厂型号:	K2A32768125202
凯越翔技术部:	董宗全

### 客户确认印栏

认证印章	负责人印章
年 月 日	年 月 日

本规格章程连同本页合共 5 页

# CRYSTAL SPECIFICATION

1. Description : Quartz Crystal
2. Nominal Frequency : 32.768 KHz
3. Center Frequency : 32.768 KHz
4. Dimension & Drawing No. : SX-2012 ; SXD-00309
5. Oscillation Mode : Fundamental
6. Cutting Mode :
7. Packing Style : TP-158
8. Measurement Instrument : S&A 250B(Calculated FL)
9. Electrical Characteristics :

[1] Operating Conditions :

Item	Symbol	MIN.	TYP.	MAX.	Unit	Condition
Operating Temperature Range	Topt	-40		85	°C	
Storage Temperature Range	Tstg	-4 0		8 5	°C	
Load Capacitance	CL		12.5		pF	
Drive Level	DL		0.1	0.5	μW	

[2] Frequency Stability :

Item	Symbol	MIN.	TYP.	MAX.	Unit	Condition
Tolerance	dF/Fo	-20		20	ppm	Refer to Center Frequency @25±3°C DL = 0.1 μW
Freq. vs Temp. Coefficient	dF/dT	-0.04	-0.036		ppm/°C <sup>2</sup>	
Turnover Temperature	TT	20	25	30	°C	
Aging	dF/F25	-3		3	ppm	Per Year

dF/Fo: Frequency Deviation Refer to Center

Frequency dF/F25: Frequency Deviation Refer  
to 25 °C Frequency

[3] Electrical Performance :

Item	Symbol	MIN.	TYP.	MAX.	Unit	Condition
Equivalent Series Resistance	ESR			30	kΩ	@Series
Shunt Capacitance	Co	1.1	1.5	1.9	pF	
Motional Capacitance	C1	5	6	7	fF	
Motional Inductance	L1	3	3.8	4.6	kH	
Quality Factor	Q	9000				
Insulation Resistance	IR	500			MΩ	@DC 100 Volt

10. Marking : Laser

<p>*Y=Last 1 digit of the year          *WW=Week of the year          * CL : 12.5 -&gt;          A</p>	<div style="border: 1px solid black; width: 150px; height: 100px; margin: auto; display: flex; align-items: center; justify-content: center;">             SYWWA           </div>
--	---

11. Remark :

<p>*Lead Free, RoHS compliant</p>
-----------------------------------

TOP VIEW

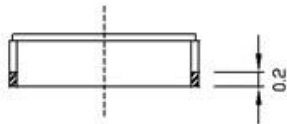
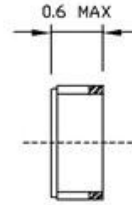
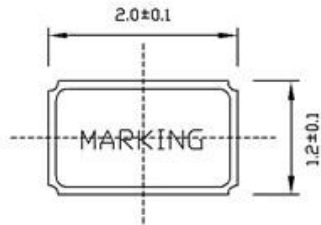

BOTTOM VIEW

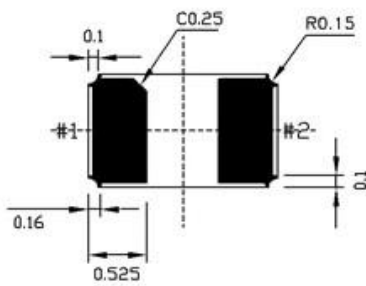

LAND PATTERN (REFERENCE)

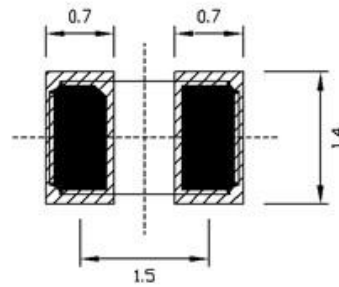

		DRAWING NAME	SX-2012 DIMENSION/MARKING
		DRAWING NO.	SXD-00309

# 1.CARRIER TYPE

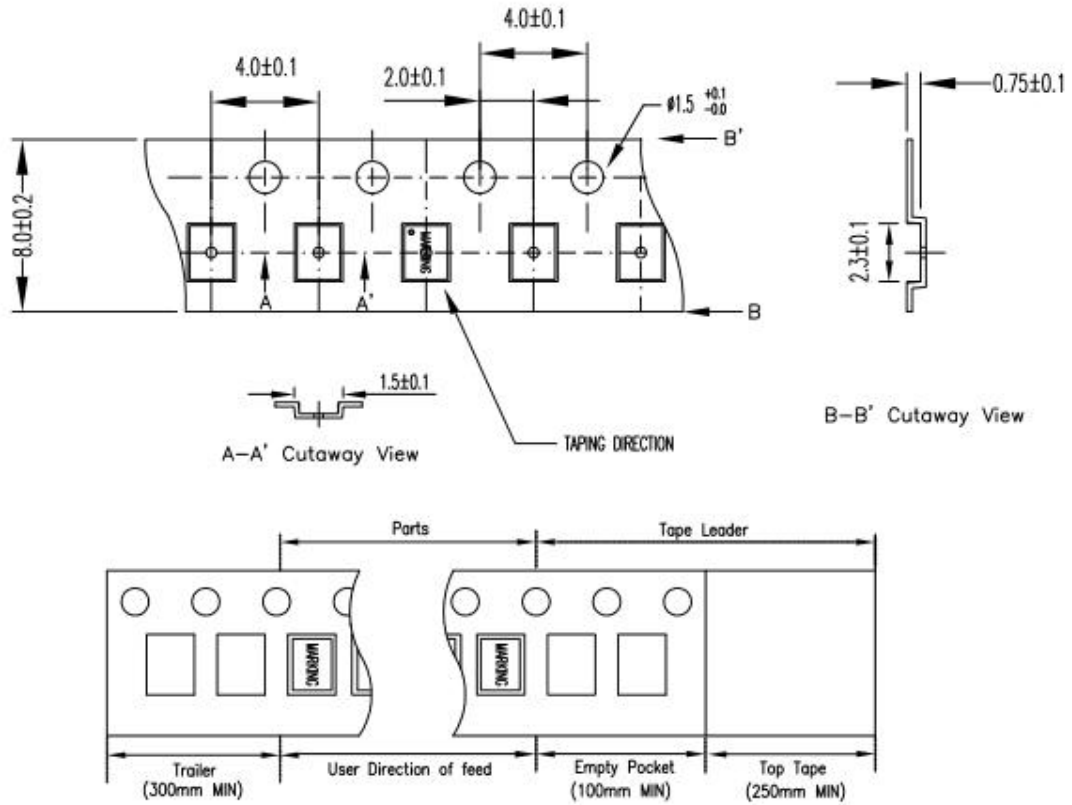

# 2.REEL : 3000PCS

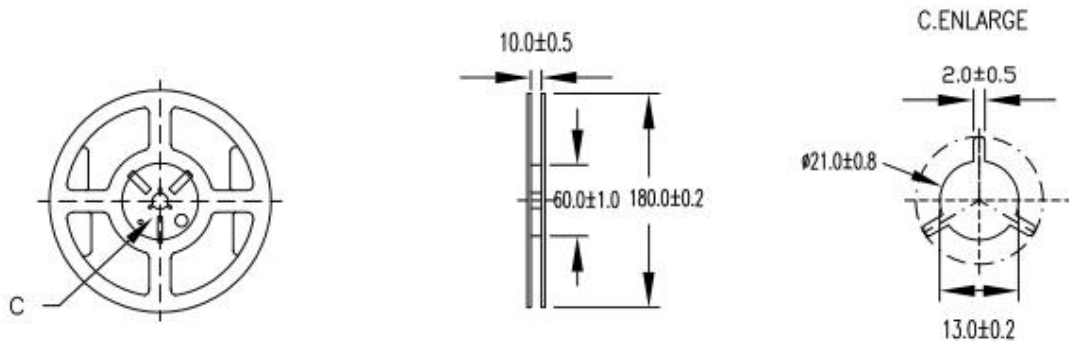

拟制	成望生	审核	董宗全	批准	谢为亮
----	-----	----	-----	----	-----

## X-ON Electronics

Largest Supplier of Electrical and Electronic Components

*Click to view similar products for [Crystals](#) category:*

*Click to view products by [KYX](#) manufacturer:*

Other Similar products are found below :

[CX3225GB25000M0PPSZ1](#) [718-13.2-1](#) [7A-40.000MAAE-T](#) [FL2000085](#) [99-BU](#) [9B-15.360MBBK-B](#) [9C-7.680MBBK-T](#) [H10S-12.000-18-EXT-TR](#) [ABC2-6.000MHZ-D4Z-T](#) [ABLS-20.000MHZ-D2-T](#) [ABS071-32.768KHZ-6-T](#) [R38-32.768-12.5-5PPM-NPB](#) [BTD1062E05A-513](#) [21U15A-21.4MHZ](#) [RTX-781DF1-S-20.950](#) [LFXTAL066198Cutt](#) [9C-14.31818MBBK-T](#) [A-11.000MHZ-27](#) [ABL-27.000MHZ-B4Y-T](#) [ABM11-132-24.000MHZ-T3](#) [ABM3B1-25.000MHZ-D2Y-T](#) [SPT2A-.032768B](#) [SPT2A.032768G](#) [LFXTAL065253Cutt](#) [LFXTAL066431Cutt](#) [XT9S20ANA14M7456](#) [XT9SNLANA16M](#) [7A-24.576MBBK-T](#) [7B-30.000MBBK-T](#) [CX2520DB16000H0HPQCC](#) [MMCC2R32.7680KHZ](#) [6504-202-1501](#) [6526-202-1501](#) [ABLS-12.000MHZ-B2Y-T](#) [7A-10.000MBBK-T](#) [SG636PCE-20.000MC](#) [3404](#) [CM315D32768EZFT](#) [C1E-24.000-7-2020-R](#) [C1E-19.200-12-1530-X-R](#) [C1E-16.000-12-1530-X-R](#) [ABM11-16.000MHZ-9-B1U-T](#) [FL5000014](#) [EUCA18-3.1872M](#) [FX0800015](#) [425F35E027M0000](#) [FP0800018](#) [MS3V-T1R-32.768kHz-7pF-20PPM-TA-QC-Au](#) [VXM7-1C1-16M000](#) [MS3V-T1R-32.768kHz-9pF-20PPM-TA-QC-Au](#)