



深圳市凯越翔电子有限公司

石英谐振器规格书

| | |
|-----------|----------------|
| 产品名称: | 石英晶振谐振器 |
| 产品型号: | 2016/32.000MHZ |
| 产品参数: | 8PF/±10PPM |
| 原厂型号: | K2B320000810 |
| 尺寸图: | P. 2 3 |
| 凯越翔实业技术部: | 董宗全 |

客户确认印栏

| | |
|-------|-------|
| 认证印章 | 负责人印章 |
| 年 月 日 | 年 月 日 |

本规格章程连同本页合共 5 页

- | | |
|--|---|
| 1. Frequency: | 30.000 MHZ |
| 2. Holder Type: | SMD2.0*1.6 |
| 3. Frequency Tolerance: | $\pm 10\text{ppm}$ at $25^\circ\text{C} \pm 3^\circ\text{C}$ |
| 4. Equivalent Series Resistance: | 60 Ω Max |
| 5. Storage Temperature Range: | $-40^\circ\text{C} \sim +85^\circ\text{C}$ |
| 6. Operating Temperature Range: | $-40^\circ\text{C} \sim +85^\circ\text{C}$ |
| 7. Frequency Characteristics Over Temperatnre: | $\pm 10\text{ppm}$ $-40^\circ\text{C} \sim +85^\circ\text{C}$ |
| 8. Load Capacitance (CL): | 8PF |
| 9. Drive Level: | 100 μ W Max |
| 10. Shunt Capacitance: | 3PF MAX |
| 11. Insulation Resistance: | $\geq 500\text{M}\Omega$ Min at 100 V |
| 12. Mode Of Oscillation: | Fundamental |
| 13. Aging: | 3ppm/Year |
| Marking description: | KYX32.000 |
| 14. Dimensiors(mm): | |

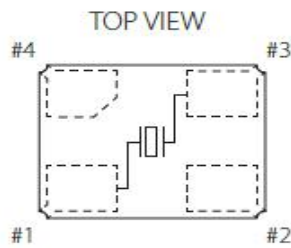
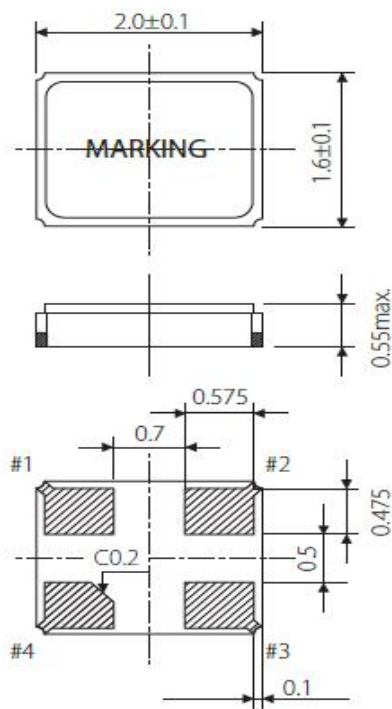

• #1,#3 : Crystal terminal / #2,#4 : Connected to cover
(Please connect it with GND.)

Example of a Terminal Land Pattern

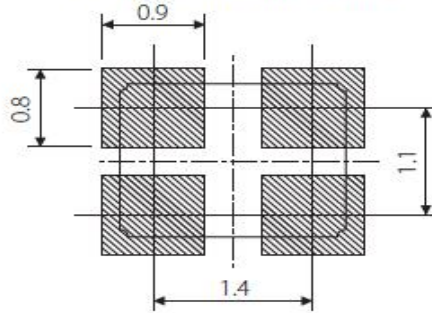

16. Structure Illustration

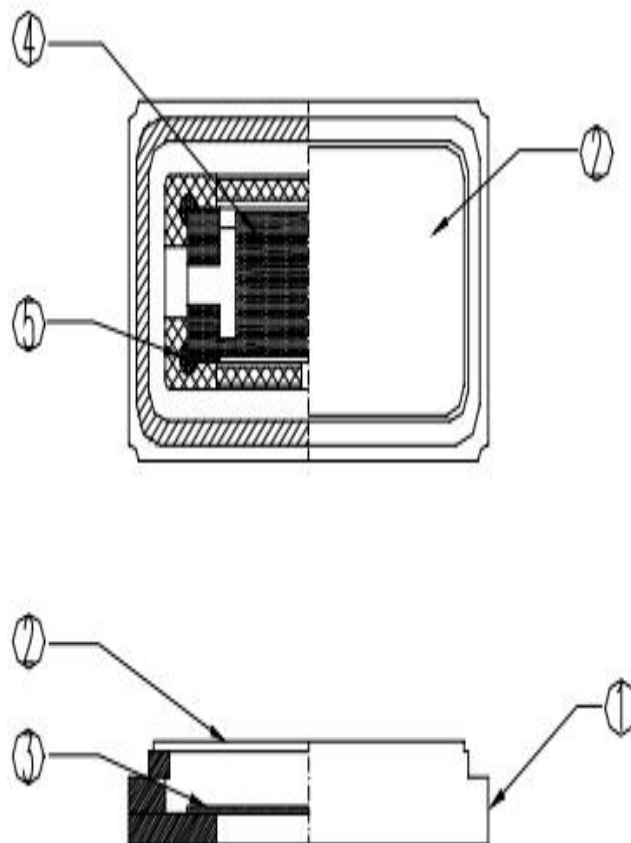

| PART NAME | | MATERIAL | PART NAME | | MATERIAL |
|-----------|-------|----------|-----------|-----------|-------------|
| 1. | BASE | CERAMIC | 4. | ELECTRODE | Metal |
| 2. | LID | Co | 5. | ADHESMES | SILVER GLUE |
| 3. | BLANK | QUARTZ | | | |

Reliability Testing 可靠性测试项目介绍

| 项目 | 验条件及要求 | 要求 |
|-----------------------------|---|--------------------------------------|
| Vibration 振动 | Endurance condition by a frequency sweep shall be made. The entire frequency range from 10HZ to 50HZ and return to 10HZ, shall be transverse in 1min. Amplitude(total excursion):1.5mm this motion shall be applied for a period of 2h each of 3 mutually perpendicular axes(a total of 6h) 振动频率: 从 10HZ 到 55HZ, 再回到 10HZ 1 倍频程/min 幅度为 1.5mm 3 个相互垂直的方向各 2 小时 | (1). FL: +/-5ppm (2). Rr: +/-5% |
| Drop 跌落 | Form 70cm height 3 times on 3cm hard wooden floor 从 70cm 高处跌落到 3cm 厚的硬质木板上, 重复 3 次 | |
| Shock 冲击 | Peak acceleration:981m/s ² duration of the pulse :6ms three successive shocks shall be applied in both direction of 3 mutually perpendicular axes(a total of 18 shocks) 加速度: 981m/s ² 时间: 6ms 作用在 3 个相互垂直的方向 | (1). FL: +/-10ppm (2). Rr: +/-8 Ω |
| Damp heat, constant 恒定湿热 | The unit shall be stored at a temperature of 40℃ ±2℃ with relative humidity of 90%to95% for 48h, then it shall be subjected to standard atmospheric conditions for 1~2h after which measurement shall be made. 在温度: 40℃ ±2℃、湿度: 90%to95%条件下存放 48 小时, 然后在标准大气压下放置 1~2 小时后测试 | |
| Cold 低温存储 | The unit shall be stored at a temperature of -40℃ ±5℃ for 48h, then it shall be subjected to standard atmospheric conditions for 1~2h after which measurement shall be made. 在 -40℃ ±5℃ 下存放 48 小时, 然后在标准大气压下放置 1~2 小时后测试 | |
| Dry heat 高温存储 | The unit shall be stored at a temperature of 100℃ ±5℃ for 24h, then it shall be subjected to standard atmospheric conditions for 1~2h after which measurement shall be made. 100℃ ±5℃ 下存放 24 小时, 然后在标准大气压下放置 1~2 小时后测试 | |
| Aging 老化 | The unit shall be stored at a temperature of 85℃ ±5℃ for 7d then it shall be subjected to standard atmospheric conditions for 1~2h after which measurement shall be made. 85℃ ±5℃ 下放置 7 天, 然后在标准大气压下放置 1~2 小时后测试 | |
| Temperature cycling | The unit shall be subjected to 5 successive change of temperature cycles, each as show in table below, then it shall be subjected to standard atmospheric conditions for 1~2h after which measurement shall be made 在下表给定温度和时间参数的条件下循环 5 次, 标准大气压下放置 1~2 小时后测试 | |

| | | | |
|------|---|--|---------------------|
| 温度循环 | | Temperature 温度 | Duration 放置时间 |
| | 1 | -40°C ± 3°C | 30min (30 分钟) |
| | 2 | Standard atmospheric conditions 标准大气压 | Within 30s 30 秒内 |
| | 3 | 100°C ± 3°C | 30min (30 分钟) |
| | 4 | Standard atmospheric conditions 标准大气压 | Within 30s 30 秒内 |

| | |
|--------------------------------------|---|
| Resistance to soldering heat 耐焊接热 | <p>250°C 217°C 200°C 150°C 25°C</p> <p>Peak 10s Max +6°C/s Max cooling +4°C/s Max preheating 60-to-120s 40-to-90s 25°C to peak: 360s TIME (Seconds) Total: 420s</p> <p>使用回流焊方法见上图</p> |
|--------------------------------------|---|

2. REEL : 3000 PCS

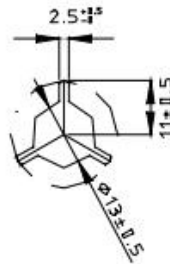
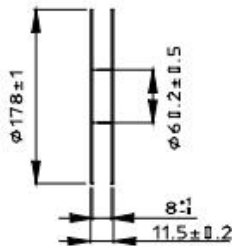
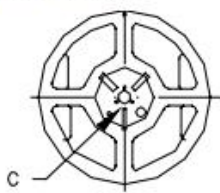

| | | | | | |
|----|-----|----|-----|----|-----|
| 拟制 | 成望生 | 审核 | 董宗全 | 批准 | 赵庸桓 |
|----|-----|----|-----|----|-----|

X-ON Electronics

Largest Supplier of Electrical and Electronic Components

Click to view similar products for [Crystals](#) category:

Click to view products by [KYX](#) manufacturer:

Other Similar products are found below :

[CX3225GB25000M0PPSZ1](#) [718-13.2-1](#) [7A-40.000MAAE-T](#) [FL2000085](#) [99-BU](#) [9B-15.360MBBK-B](#) [9C-7.680MBBK-T](#) [H10S-12.000-18-EXT-TR](#) [ABC2-6.000MHZ-D4Z-T](#) [ABLS-20.000MHZ-D2-T](#) [ABS071-32.768KHZ-6-T](#) [R38-32.768-12.5-5PPM-NPB](#) [BTD1062E05A-513](#) [21U15A-21.4MHZ](#) [RTX-781DF1-S-20.950](#) [LFXTAL066198Cutt](#) [9C-14.31818MBBK-T](#) [A-11.000MHZ-27](#) [ABL-27.000MHZ-B4Y-T](#) [ABM11-132-24.000MHZ-T3](#) [ABM3B1-25.000MHZ-D2Y-T](#) [SPT2A-.032768B](#) [SPT2A.032768G](#) [LFXTAL065253Cutt](#) [LFXTAL066431Cutt](#) [XT9S20ANA14M7456](#) [XT9SNLANA16M](#) [7A-24.576MBBK-T](#) [7B-30.000MBBK-T](#) [CX2520DB16000H0HPQCC](#) [MMCC2R32.7680KHZ](#) [6504-202-1501](#) [6526-202-1501](#) [ABLS-12.000MHZ-B2Y-T](#) [7A-10.000MBBK-T](#) [SG636PCE-20.000MC](#) [3404](#) [CM315D32768EZFT](#) [C1E-24.000-7-2020-R](#) [C1E-19.200-12-1530-X-R](#) [C1E-16.000-12-1530-X-R](#) [ABM11-16.000MHZ-9-B1U-T](#) [FL5000014](#) [EUCA18-3.1872M](#) [FX0800015](#) [425F35E027M0000](#) [FP0800018](#) [MS3V-T1R-32.768kHz-7pF-20PPM-TA-QC-Au](#) [VXM7-1C1-16M000](#) [MS3V-T1R-32.768kHz-9pF-20PPM-TA-QC-Au](#)