



深圳市凯越翔电子有限公司

贴片晶振规格书

产品名称:	贴片晶振
产品型号:	5032/12.000 MHZ
产品参数:	15PF/±20ppm
原厂型号:	K5A120001520
凯越翔技术部:	董宗全

客 户 确 认 栏

认 证 印 章	负 责 人 印 章
年 月 日	年 月 日

本规格章程连同本页共 5 页

1. General item

Nominal frequency: **12.000 MHz**

Vibration mode: AT Fund.

Operation temperature range: **-40°C~+85°C**

Storage temperature rang: **-40°C~+85°C**

Test machine: **S&A 250B**

Drive level: **100 μ W**

Load capacitance: **15 pF**

2. Electrical characteristics

Condition: **25 \pm 3°C** Relatively humidity \leq **60%**

2.1 Frequency tolerance: **\pm 20ppm**

2.2 Equivalent resistance: \leq **80 Ω**

2.3 Temperature characteristics: **\pm 20ppm**

2.4 Shunt capacitance: \leq **7pF**

2.5 Insulation resistance: \geq **500M Ω / 100 \pm 15V_{DC}**

2.6 Aging characteristics: **\pm 5ppm/year**

3. Reliability specification

3.1 Drop characteristics

Condition: height 50cm, 3 times, test after 1 hour

Equipment: S&A250B, thickness 3cm hard wood

Standard: frequency change: \leq **\pm 5ppm**, Rr as specification

3.2 Shake characteristics

Condition: shake frequency 10~55Hz, cyc1~2 minutes, swing 1.5mm,
direction x/y/z, all 30 minutes. Test after 1 hour

Equipment: S&A250B, test machine

Standard: frequency change: \leq **\pm 5ppm**, Rr as specification

3.3 Airproof characteristics

Condition: put crystal into the pressure cabin with alcohol, keep pressure 0.4-0.5mpa 10 minutes, then take out and blow for 5 minutes

Equipment: IR machine

Standard: IR $\geq 500 \text{ m}\Omega$

3.4 Weld characteristics

Condition: $235 \pm 5^\circ\text{C}$ 、3 seconds

Equipment: test machine

Standard: 90% adhibit tin ok

3.5 Humidity characteristics

Condition: $40^\circ\text{C} \pm 2^\circ\text{C}$, humidity 90-95%,250 hours.

Equipment: S&A250B, test cabin

Standard: frequency change: $\leq \pm 5\text{ppm}$, Rr as specification

3.6 Low temperature characteristics

Condition: $-30^\circ\text{C} \pm 2^\circ\text{C}$, after 250 hours, put in room temperature 1 hour

Equipment: S&A250B, test machine

Standard: frequency change: $\leq \pm 5\text{ppm}$, Rr as specification

3.7 High temperature characteristics

Condition: $85^\circ\text{C} \pm 2^\circ\text{C}$, after 250 hours, put in room temperature 1 hour

Equipment: S&A250B, test machine

Standard: frequency change: $\leq \pm 5\text{ppm}$, Rr as specification

3.8 Temperature cycling

Condition:



AFTER TEMPERATURE CYCLING

Equipment: S&A250B, test machine。

Standard: frequency change: $\leq \pm 5\text{ppm}$, Rr as specification

3.9 Refluence examination

Condition:

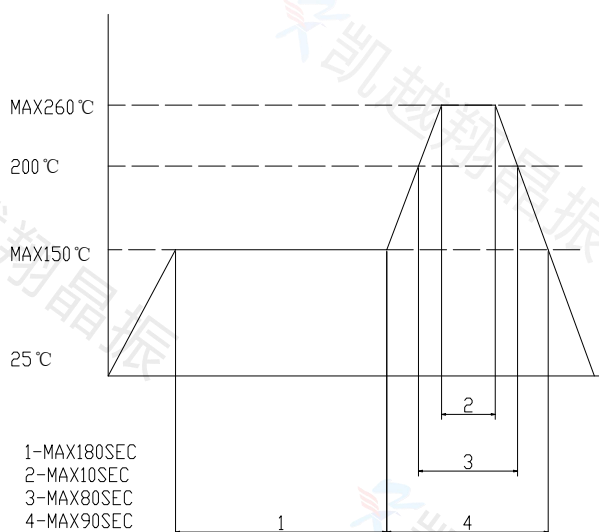

Equipment: S&A250B, test machine

Standard: frequency change: $\leq \pm 10\text{ppm}$,

Rr as specification

External dimensions

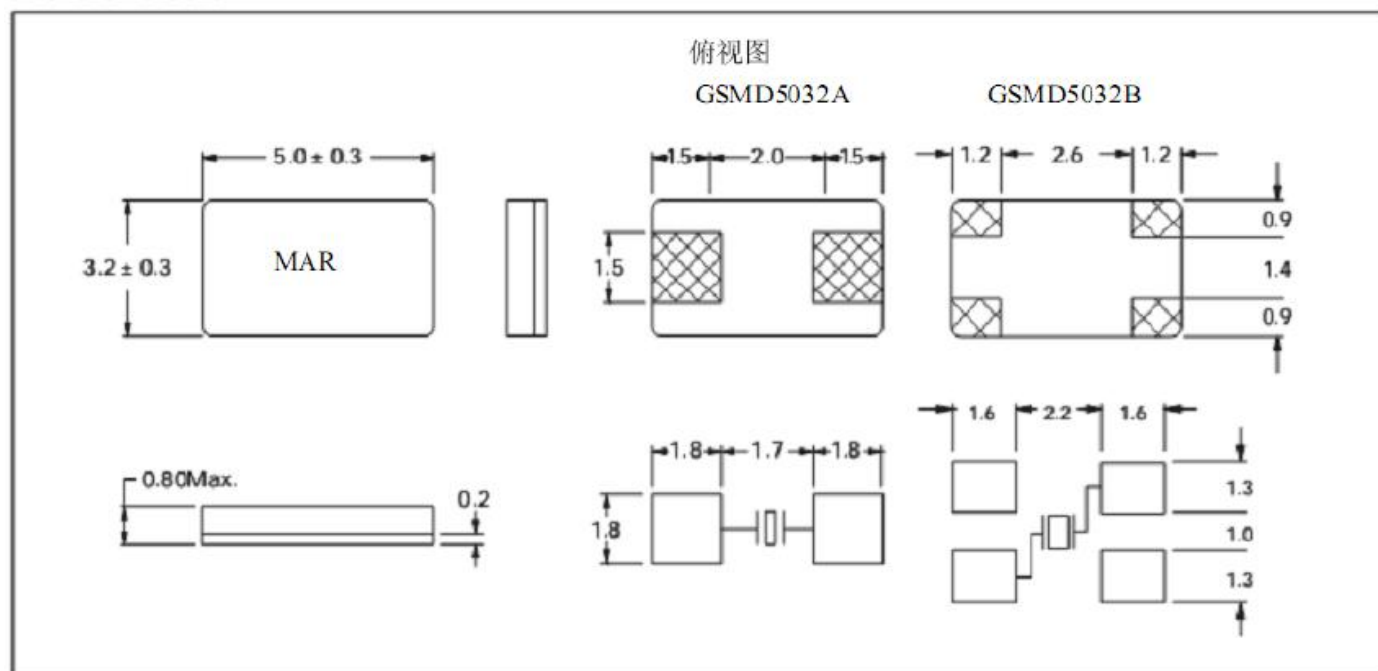

Dimension: mm

X-ON Electronics

Largest Supplier of Electrical and Electronic Components

Click to view similar products for [Crystals](#) category:

Click to view products by [KYX](#) manufacturer:

Other Similar products are found below :

[CX3225GB25000M0PPSZ1](#) [718-13.2-1](#) [7A-40.000MAAE-T](#) [FL2000085](#) [99-BU](#) [9B-15.360MBBK-B](#) [9C-7.680MBBK-T](#) [H10S-12.000-18-EXT-TR](#) [ABC2-6.000MHZ-D4Z-T](#) [ABLS-20.000MHZ-D2-T](#) [ABS071-32.768KHZ-6-T](#) [R38-32.768-12.5-5PPM-NPB](#) [BTD1062E05A-513](#) [21U15A-21.4MHZ](#) [RTX-781DF1-S-20.950](#) [LFXTAL066198Cutt](#) [9C-14.31818MBBK-T](#) [A-11.000MHZ-27](#) [ABL-27.000MHZ-B4Y-T](#) [ABM11-132-24.000MHZ-T3](#) [ABM3B1-25.000MHZ-D2Y-T](#) [SPT2A-.032768B](#) [SPT2A.032768G](#) [LFXTAL065253Cutt](#) [LFXTAL066431Cutt](#) [XT9S20ANA14M7456](#) [XT9SNLANA16M](#) [7A-24.576MBBK-T](#) [7B-30.000MBBK-T](#) [CX2520DB16000H0HPQCC](#) [MMCC2R32.7680KHZ](#) [6504-202-1501](#) [6526-202-1501](#) [ABLS-12.000MHZ-B2Y-T](#) [7A-10.000MBBK-T](#) [SG636PCE-20.000MC](#) [3404](#) [CM315D32768EZFT](#) [C1E-24.000-7-2020-R](#) [C1E-19.200-12-1530-X-R](#) [C1E-16.000-12-1530-X-R](#) [ABM11-16.000MHZ-9-B1U-T](#) [FL5000014](#) [EUCA18-3.1872M](#) [FX0800015](#) [425F35E027M0000](#) [FP0800018](#) [MS3V-T1R-32.768kHz-7pF-20PPM-TA-QC-Au](#) [VXM7-1C1-16M000](#) [MS3V-T1R-32.768kHz-9pF-20PPM-TA-QC-Au](#)