



深圳市凯越翔实业

石英谐振器规格书

产品名称:	石英晶体谐振器
产品型号:	49USSMD/12.000MHZ
产品参数:	20PF/±20ppm
原厂型号:	KBD120002020
尺寸图:	P. 4
凯越翔实业技术部:	董宗全

客 户 确 认 栏

认证印章	负责人印章
年 月 日	年 月 日

本规格章程连同本页共 5 页

产品规格书

1.GENERAL	
1.1 HOLDER TYPE	49USSMD
1.2 MODE OF VIBRATION	AT CUT
1.3 OSCILLATION MODE	FUND
1.4 TEST FACILITIES	S&A KH-1240
1.5 STORAGE TEMPERATURE	-40℃ TO +85℃
1.6 DRIVER LEVEL	100 μ W
2.ELECTRICAL PARAMETER	
2.1 NORMAL FREQUENCY	12.000MHz
2.2 FREQUENCY TOLERANCE (25℃ ±2℃)	±20ppm
2.3 TEMPERATURE STABILITY	±20ppm
2.4 OPERATING TEMPERATURE RANGE	-20℃ TO + 70℃
2.5 LOAD CAPACITANCE	20PF
2.6 MOTIONAL CAPACITANCE	
2.7 SHUNT CAPACITANCE	7PF MAX
2.8 EFFECTIVE SERIES RESISTANCE	40 Ω MAX
2.9 INSULATION RESISTANCE	500M OHMS MIN AT DC 100V
3.MECHANICAL PARAMETER	
3.1 SOLDERABILITY	95%COVERAGE BY USING 90/10 SOLD AT 245℃ FOR 5 SEC. DIPPING AFTER IMMERSION IN ALPHA 611 FLUX FOR 5 SEC.

<p>I MECHANICAL ENDURANCE 机械特性</p> <p>Provided that measurement shall be carried out after letting it alone in the room temperature for 1 hour. 试验产品应在室温下放置 1 小时后方可进行以下试验。</p> <p>①SHOCK 抗击测试</p> <p>Electrical characteristics shall be satisfied after dropping three time from the height of 50 cm onto Hard wooden board . 产品从 50 cm 高度自由落下到硬木板 3 次电气参数仍符合要求。</p> <p>②VIBRATION 抗振测试</p> <p>Electrical characteristics shall be satisfied after supplying following Vibration . 电气性能应满足以下的振动要求。</p> <table border="0"> <tr> <td>(1)VIBRATION FREQUENCY</td> <td>振动频率</td> <td>10—55Hz</td> </tr> <tr> <td>(2)REPEATED PERIOD</td> <td>周 期</td> <td>1—2min</td> </tr> <tr> <td>(3)FULL CYCLE</td> <td>全 振 幅</td> <td>1.5mm P—P</td> </tr> <tr> <td>(4)DIRECTION</td> <td>振动方向</td> <td>X.Y.Z</td> </tr> <tr> <td>(5)TIME</td> <td>振动时间</td> <td>2hours/each direction 2 小时/每个方向</td> </tr> </table> <p>③STRENGTH OF TERMINALS/LEAD—WIRES 引脚与基座底部的强度测试</p> <p>-1 PULLING 拉力测试</p> <p>a)Body of specimen shall be fixed, and 900g of tension weight shall be supplied gradually to axial direction of terminals/lead-wires for 30 sec . 产品应固定在 900g 的拉力的情况下逐渐延基座底部/引线脚中轴方向拉 30 秒钟。</p> <p>b)After above test a), there is no observation of any visual damages on the specimen. 经过 a)的测试, 产品应没有任何可以目测到的损坏。</p> <p>-2 BENDING 弯曲度测试</p> <p>a)Body of specimen shall be fixed, and 90degree bending shall be given, being supplied 225gs tension weight . After that, terminals/lead-wires shall be straightened gradually . Then the same bending and straightening shall be supplied to the opposite direction in the same axial . (Refer to Fig-1) 产品固定后, 以 90° 的弯曲并供以 225g 的拉力, 然后沿同一轴线并与相反的方向 90° 的弯曲及伸直。(产品结构如图 1 所示)</p> <p>b)After above test a), there is no observation of any visual damages on the specimen . 通过 a)测试后, 晶体上应没有任何可以目测到的损坏。</p>		(1)VIBRATION FREQUENCY	振动频率	10—55Hz	(2)REPEATED PERIOD	周 期	1—2min	(3)FULL CYCLE	全 振 幅	1.5mm P—P	(4)DIRECTION	振动方向	X.Y.Z	(5)TIME	振动时间	2hours/each direction 2 小时/每个方向
(1)VIBRATION FREQUENCY	振动频率	10—55Hz														
(2)REPEATED PERIOD	周 期	1—2min														
(3)FULL CYCLE	全 振 幅	1.5mm P—P														
(4)DIRECTION	振动方向	X.Y.Z														
(5)TIME	振动时间	2hours/each direction 2 小时/每个方向														



④ SEALING TIGHTNESS 气密性测试

There is no observation of gas bubble after specimen put in hot water at +90°C—+95°C for 5 min .

晶体置于+90°C—+95°C的热水中 5 分钟，应没有气泡产生。

⑤ SOLDERING DIP 浸锡测试

Terminals/lead-wires of specimen shall be dipped into solder melted tank at +230°C—±5°C for 3sec . Dipping depth shall be 2mm from the bottom of specimens body . (After applying ROSIN flux) Soldering portion shall be covered in over 90% of terminals/lead-wires dipped .

将晶体引线脚置于+230°C—±5°C的锡桶中 3 分钟，基座底部离锡表面 2mm，（加上松香焊剂后）引线脚的沾锡率为 90%以上。

⑥ SOLDER HEATING 沾锡耐热性测试

Terminals/lead-wires of specimen shall be dipped into solder melted tank at

+350°C—±10°C for $\frac{1}{3}$ ₋₀ sec .

Electrical characteristics shall be satisfied after dipping depth shall be 2mm from edge of terminals/lead-wires .

将已沾锡的产品的引线脚置于+350°C—±10°C的锡桶中 3-4 秒钟后 基座底部离锡表面 2mm，电气性能仍符合要求。

II ENVIRONMENTAL ENDURANCE 环境特性

Provided that measurement shall be carried out after letting it alone in the room temperature for 1 hour .

必须将试验产品在室温下放置 1 小时后方可进行测试。

① HUMIDITY 耐湿测试

Electrical characteristics shall be satisfied after letting it alone at 60°C—±2°C in humidity of 90—95% for 250 hours .

试验产品在温度为 60°C—±2°C，相对湿度 90—95%的试验箱内放置 250 小时后电气性能仍符合要求。

② STORAGE IN LOW TEMPERATURE 低温储存测试

Electrical characteristics shall be satisfied after letting it alone at -30°C—±2°C for 250 hours .

试验产品在温度为-30°C—±2°C的试验箱中放置 250 小时后电气性能仍符合要求。

③ STORAGE IN HIGH TEMPERATURE 高温储存测试

Electrical characteristics shall be satisfied after letting it alone at +85°C—±2°C for 250 hours .

试验产品在温度为+85°C—±2°C的试验箱中放置 250 小时后电气性能仍符合要求。

④ TEMPERATURE CYCLE 温度变换测试

Electrical characteristics shall be satisfied after supplying the following temperature cycle (3cycles) .

Temperature shift from low to high, high to low shall be done in 1°C/min (Refer to Fig-2) .

电气性能应满足以下温度周期要求（3 个周期）

温度变换从低到高，从高到低变化量为 1°C/分。（如图 2 所示）

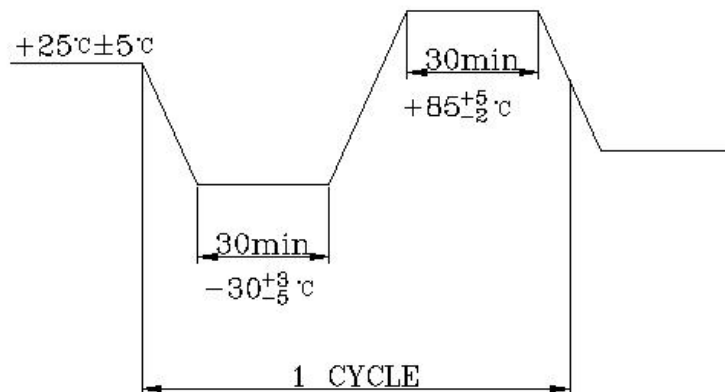

PIG — 2

拟 制	成望生	审 核	董宗全	批 准	赵庸桓
-----	-----	-----	-----	-----	-----

X-ON Electronics

Largest Supplier of Electrical and Electronic Components

Click to view similar products for [Crystals](#) category:

Click to view products by [KYX](#) manufacturer:

Other Similar products are found below :

[CX3225GB25000M0PPSZ1](#) [718-13.2-1](#) [MC405 32.0000K-R3:PURE SN](#) [7A-40.000MAAE-T](#) [FL2000085](#) [99-BU](#) [9B-15.360MBBK-B](#) [9C-7.680MBBK-T](#) [H10S-12.000-18-EXT-TR](#) [ABC2-6.000MHZ-D4Z-T](#) [ABLS-20.000MHZ-D2-T](#) [ABS071-32.768KHZ-6-T](#) [R38-32.768-12.5-5PPM-NPB](#) [BTD1062E05A-513](#) [21U15A-21.4MHZ](#) [RTX-781DF1-S-20.950](#) [LFXTAL066198Cutt](#) [9C-14.31818MBBK-T](#) [A-11.000MHZ-27](#) [ABL-27.000MHZ-B4Y-T](#) [ABM11-132-24.000MHZ-T3](#) [ABM3B1-25.000MHZ-D2Y-T](#) [SPT2A-.032768B](#) [SPT2A.032768G](#) [SSPT7F-9PF20-R](#) [FX325BS-38.88EEM1201](#) [LFXTAL065253Cutt](#) [LFXTAL066431Cutt](#) [XT9S20ANA14M7456](#) [XT9SNLANA16M](#) [646G-24-2](#) [7A-24.576MBBK-T](#) [7B-30.000MBBK-T](#) [7A-14.31818MBBK-T](#) [6504-202-1501](#) [6526-202-1501](#) [ABLS-12.000MHZ-B2Y-T](#) [7A-10.000MBBK-T](#) [SG636PCE-20.000MC](#) [3404](#) [E1SAA18-25.000M TR](#) [CM315D32768EZFT](#) [C1E-24.000-7-2020-R](#) [C1E-19.200-12-1530-X-R](#) [C1E-16.000-12-1530-X-R](#) [ABM11-16.000MHZ-9-B1U-T](#) [FL5000014](#) [EUCA18-3.1872M](#) [FX0800015](#) [425F35E027M0000](#)